



FESTA

PROFI X SZERSZÁMOK



20
25
—
26

FESTA
POWER X TOOLS

Elektromos és akkumulátoros szerszámok (AKKUS gépek) minőségi alkatrészekkel, a legújabb technológiákkal és a jelenlegi trendekkel ebben a kínálatban

FESTA

A professzionális kéziszerszámok márkája az építőiparban, műhelyekben és a kertben

FESTA
INDUSTRY

Válogatott, kiváló minőségű szerszámok és kéziszerszámok prémium választéka, melyek magas követelményekhez készültek, ahol a hangsúly a teljesítményen van

FESTA
AQUATIC

Profi öntözéstechnika választék, modern formák, rosa termékekkel kompatibilis

HORIZONT
MASTER

Csúcsminőségű vízszintmérők

HORIZONT

Csúcsminőségű vízszintmérők és léce

ROSA

Minőségi öntözőrendszerek és kerti szerszámok

KDS[®]

Japán kések sokéves hagyománnyal

KOMELON[®]

Professzionális mérőeszközök



Professzionális csempevágók



Minőségi kerti ollók gyártója

Lescha

Professzionális építőanyag keverők

Stahlberg

Professzionális csavarhúzó készletek



Professzionális furésmárkák

AKKUS ÉS ELEKTROMOS SZERSZÁMOK

2 - 53



VÁGÓ ÉS CSISZOLÓ ESZKÖZÖK

54 - 93



SZERSZÁMOK

94 - 205



MŰHELY

206 - 241



KŐMŰVES SZERSZÁMOK

242 - 307

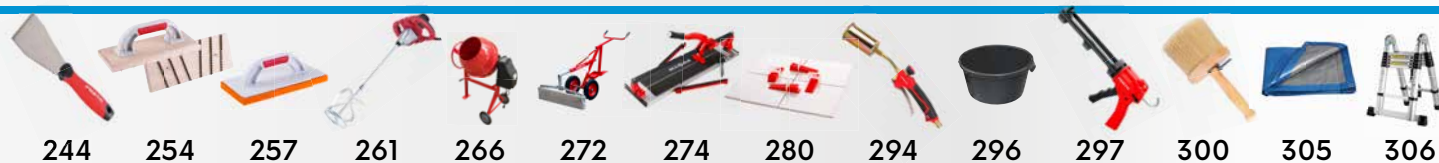

KERTI SZERSZÁMOK ÉS KERÍTÉS

308 - 359



FESTA

360 - 365



CIKKSZÁM RENDEZO

366 - 380



FÚRÓ

4



ÜTVEFÚRÓ

9



TŰZŐ-SZEGEZŐGÉP

10



SAROKCSISZOLÓ

11



CSISZOLÓ

12



KÖRFŰRÉSZ

13



KOMPRESSZOR

15



VIBRÁCIÓS CSEMPÉZŐ

16



TÖMÍTŐ PISZTOLY

17



LED LÁMPA

17



RÁDIÓ DAB+ / FM / BT

18



ÜTVEFÚRÓ

23



KÖRFŰRÉSZ

26



SAROKCSISZOLÓ

27



GIPSZKARTON CSISZOLÓ

36



PORSZÍVÓK

37



ELEKTROMOS KEVERŐGÉP

38



NAGYNYOMÁSÚ TISZTÍTÓK

39



POLISZTIROL VÁGÓGÉPEK

40



HEGESZTŐ INVERTER

43



POLIFÚZIÓS HEGESZTŐK

45



KOMPRESSZOROK ÉS KIEGÉSZÍTŐK

46



HŐLÉGFEGYVEREK

50



MELEGÍTŐK

52



HOSSZABBÍTÓ KÁBELEK

53



ELEKTROMOS
SZERSZÁMOK

2 - 53



FESTA
POWER X TOOLS

BRUSHLESS **SHARE** **Li-ion**
20V *technology*

sebesség
0-550 min⁻¹
0-2000 min⁻¹

tömeg
akkumulátorral 2,0 A **1,8 kg**
akkumulátorral 4,0 Ah **2,1 kg**

nyomaték
80 Nm

tokmány
2 – 13 mm



- A készlet tartalmaz:
- ütvefúró
 - 2,0 Ah akkumulátor
 - 4,0 Ah akkumulátor
 - 2,4 A töltő
 - kiegészítő fogantyú
 - bőrönd



FESTA
POWER X TOOLS

AKKUS FÚRÓKALAPÁCS

max 80 Nm		L: 0-8800 bpm H: 0-32000 bpm	L: 0-550 min ⁻¹ H: 0-2000 min ⁻¹				LED	KG 1,4	2x	Li-ion
--------------	--	---------------------------------	---	--	--	--	-----	-----------	----	--------



R.s. leírás
28000

BRUSHLESS SHARE 20V *Li-ion technology*

sebesség
0-550 min⁻¹
0-2000 min⁻¹

tömeg
akkumulátorral 2,0 Ah
1,8 kg
akkumulátorral 4,0 Ah
2,1 kg

nyomaték
80 Nm

tokmány
2 - 13 mm

A készlet tartalmazza:
- ütvefúró
- 2,0 Ah akkumulátor
- 2,4 A töltő
- kiegészítő fogantyú
- bőrönd



mód kiválasztása
nyomaték erő választása

kiegészítő fogantyú

sebesség kapcsoló

gyors kioldás tokmány fej

ergonomikus gumírozott fogantyú a kényelmes és biztos fogásért

LED világítás

akkumulátor zár

forgásirány kapcsoló

horog akasztáshoz



AKKUS FÚRÓKALAPÁCS



R.s.
28001

leírás

2

BRUSHLESS SHARE 20V

sebesség
0-550 min⁻¹
0-2000 min⁻¹

tömeg
akkumulátor
nélkül
1,4 kg

nyomaték
80 Nm

tokmány
2 - 13 mm

ajánlott kiegészítők

SHARE 20V *Li-ion technology*

2 Ah - 28080
akkumulátor* 4 Ah - 28081
8 Ah - 28083
2,4 A - 28085
4,0 A - 28086
töltő*



mód kiválasztása
nyomaték erő választása

kiegészítő fogantyú

sebesség kapcsoló

gyors kioldás tokmány fej

ergonomikus gumírozott fogantyú a kényelmes és biztos fogásért

LED világítás

forgáskapcsoló

horog akasztáshoz



AKKUS FÚRÓKALAPÁCS



*akkumulátor nem tartozék

R.s.
28002

leírás

5

SHARE
20VLi-ion
technology

sebesség
0-500 min⁻¹
0-1800 min⁻¹

tömeg
akkumulátorral
2,0 Ah
1,7 kg

nyomaték
45 Nm

tokmány
2 - 13 mm

A készlet tartalmaz:

- ütvefűrő
- 2x 2.0 Ah Akkumulátor
- 2.4 A töltő
- bőrönd
- hordozó és bitek:
- ⊖ S5, S6 x 25 mm
- ⊕ PH1, PH2 x 25 mm
- ⊕ PZ1, PZ2 x 25 mm
- HSS fűrészek
- 2-2.5-3-4-5-6 mm



mód kiválasztása
nyomaték erő választása

gyors kioldás
tokmány fej

ergonomikus gumírozott
fogantyú a kényelmes és
biztos fogásért

LED világítás

akkumulátor zár

sebesség kapcsoló

forgásirány

horog akasztáshoz

FESTA
POWER X TOOLS

AKKUS FÚRÓKALAPÁCS

R.s.
28003

leírás

3

SHARE
20V

sebesség
0-550 min⁻¹
0-2000 min⁻¹

tömeg
akkumulátor
nélkül
1,4 kg

nyomaték
45 Nm

tokmány
2 - 13 mm

ajánlott kiegészítők

SHARE
20V
Li-ion
technology

- 2 Ah - 28080
- akkumulátor* 4 Ah - 28081
- 8 Ah - 28083
- 2,4 A - 28085
- töltő* 4,0 A - 28086



mód kiválasztása
nyomaték erő választása

gyors kioldás
tokmány fej

ergonomikus gumírozott
fogantyú a kényelmes és
biztos fogásért

LED világítás

sebesség kapcsoló

forgásirány

horog akasztáshoz

FESTA
POWER X TOOLS

AKKUS FÚRÓKALAPÁCS



*akkumulátor nem tartozék

R.s.
28004

leírás

5

SHARE
20V *Li-ion*
technology

sebesség
0-350 min⁻¹
0-1300 min⁻¹

tömeg
akkumulátorral
2,0 Ah
1,3 kg

nyomaték
28 Nm

tokmány
1 - 10 mm

A készlet tartalmaz:

- ütvefűrő
- 2x 2.0 Ah Akkumulátor
- 2.4 A töltő
- bőrönd
- hordozó és bitek:
- ⊖ S5, S6 x 25 mm
- ⊕ PH1, PH2 x 25 mm
- ⊕ PZ1, PZ2 x 25 mm
- fűrők HSS
- 1,5-2,5-3-4-5-6 mm



mód kiválasztása
nyomaték erő választása

gyors kioldás
tokmány fej

sebesség kapcsoló

forgásirány
kapcsoló

ergonomikus gumírozott
fogantyú a kényelmes és
biztos fogásért

LED világítás

akkumulátor zár

horog
akasztáshoz



FÚRÓ AKKUS CSAVARHÚZÓ



R.s.
28005

leírás

3

SHARE
20V

sebesség
0-350 min⁻¹
0-1300 min⁻¹

tömeg
akkumulátor
nélkül
0,9 kg

nyomaték
28 Nm

tokmány
1 - 10 mm

ajánlott kiegészítők

SHARE
20V *Li-ion*
technology

- 2 Ah - 28080
- akkumulátor* 4 Ah - 28081
- 8 Ah - 28083
- 2,4 A - 28085
- töltő* 4,0 A - 28086



mód kiválasztása
nyomaték erő választása

gyors kioldás
tokmány fej

sebesség kapcsoló

forgásirány
kapcsoló

ergonomikus gumírozott
fogantyú a kényelmes és
biztos fogásért

LED világítás

horog
akasztáshoz



FÚRÓ AKKUS CSAVARHÚZÓ



*akkumulátor nem tartozék

R.s.
28006

leírás

5

Li-ion
technology

sebesség
0-350 min⁻¹
0-1300 min⁻¹

tömeg
akkumulátorral
1,5 Ah
1 kg

nyomaték
20 Nm

tokmány
1 - 10 mm

A készlet tartalmaz:

- ütvefúró
- 2x Akkumulátor 12 V | 1.5 Ah
- töltő 12 V | 2.4 A
- bőrönd
- hordozó és bitek:
- ⊖ S5, S6 x 25 mm
- ⊕ PH1, PH2 x 25 mm
- ⊕ PZ1, PZ2 x 25 mm
- fúrók HSS
1,5-2,5-3-4-5-6 mm



mód kiválasztása
nyomaték erő választása

gyors kioldás
tokmány fej

sebesség kapcsoló

LED világítás

akkumulátor töltésjelző

forgásirány

ergonomikus gumírozott fogantyú
a kényelmes és biztos fogásért

akkumulátor



FESTA
POWER X TOOLS

FÚRÓ AKKUS CSAVARHÚZÓ



R.s.
28007

leírás

5

Li-ion
technology

sebesség
teher nélkül
200 min⁻¹

tömeg
akkumulátorral
1,5 Ah
0,4 kg

maximum nyomaték
3 Nm

szorítófej
1/4" hex

A készlet tartalmaz:

- csavarhúzó
- töltő 5 V | 0,5 A
- hordozó és bitek:
- ⊖ S5 x 50 mm
- ⊕ PH1 x 50 mm
- ⊕ PH2 x 50 mm
- H5 x 50 mm
- ⊕ T20 x 50 mm

1/4" gyorskioldó fej
biztosítékkal

settings nyomaték

akkumulátor charge indicator

zár beállítása
fogantyú helyzete

LED világítás

forgásirány kapcsoló

ergonomikus gumírozott
fogantyú a kényelmes
és biztos fogásért



LED világítás

FESTA
POWER X TOOLS

AKKUS CSAVARHÚZÓ



R.s.
28008

leírás

10

**SHARE
20V**

sebesség
teher nélkül
0-2000 min⁻¹

tömeg
akkumulátor
nélkül
1,2 kg

nyomaték
150 Nm

szám
az agyvérzések
0-3000 bpm

1/4" gyorskioldó fej
biztosítókkal



választható
forgásirány

ergonomikus gumírozott
fogantyú a kényelmes és
biztos fogásért

LED világítás

horog akasztáshoz

**SHARE
20V
Li-ion
technology**

ajánlott kiegészítők

2 Ah - 28080
akkumulátor* 4 Ah - 28081
8 Ah - 28083

2,4 A - 28085
4,0 A - 28086
töltő*



AKKUS ÜTVECSAVARÓZÓ



*akkumulátor nem tartozék

R.sz.
28021

leírás



5

**SHARE
20V**

sebesség
teher nélkül
**I.0-300 min⁻¹
II.0-1000 min⁻¹**

tömeg
akkumulátor
nélkül
1,7 kg

találatok száma
0-5000 bpm

fogantyú
SDS+

mélylési stop

munkamód váltás
(ütőhangszerrel / anélkül)

SDS rögzítés
szerszámfej

sebesség kapcsoló

irány
a forgás
kapcsoló



**SHARE
20V
Li-ion
technology**

2 Ah - 28080
akkumulátor* 4 Ah - 28081
8 Ah - 28083

2,4 A - 28085
4,0 A - 28086
töltő*



VEZETÉK NÉLKÜLI ÜTVEFÚRÓ



*akkumulátor nem tartozék

R.sz.
28025

leírás



MAX Ø beton - Ø 20 mm
fémek - Ø 10 mm
erdő - Ø 20 mm



2

SHARE
20V

frekvencia lövés
60-100 min⁻¹

maximális hossza szögek / kapcsok
30 mm kemény anyagok

maximális hossza szögek / kapcsok
50 mm puha anyagok

tömeg akkumulátor nélkül
2,7 kg

ajánlott kiegészítők

SHARE
20V
Li-ion technology

akkumulátor* 2 Ah - 28080
4 Ah - 28081
8 Ah - 28083

töltő* 2,4 A - 28085
4,0 A - 28086



biztosíték

LED hibajelzés

ergonomikus gumírozott fogantyú forr kényelmes és biztos fogás

biztosíték működtető kapcsoló

horog akasztáshoz

fényképezési mód kapcsoló

LED világítás

üres tálca mutatója



biztosíték

ütőerő szabályozása



mozgatható magazin borítója

magazin borítózár

Szögek

23930 Szeg 30 mm, 2000 pcs
23931 Szeg 40 mm, 2000 pcs
23932 Szeg 50 mm, 2000 pcs

Tűzőkapocs

23935 Tűzőkapocs 30 mm, 2000 pcs
23936 Tűzőkapocs 40 mm, 2000 pcs

Megfelelő szög- és kapcs típusok:

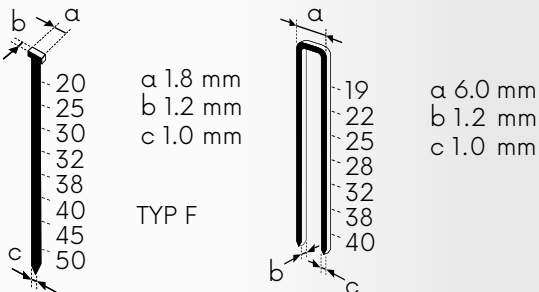

AKKUS SZEGEZŐ ÉS TŰZŐGÉP



*akkumulátor nem tartozék

R.s. leírás
28070



BRUSHLESS SHARE 20V

sebesség
teher nélkül
8500 min⁻¹

tömeg
akkumulátor
nélkül
1,6 kg

maximális
vastagság
vágott anyag
15 mm

maximális
kerék átmérője
125 mm

motor szellőzőnyílásai

ergonomikus gumírozott fogantyú a kényelmes és biztos fogásért

forgászár

biztosíték
működtető
kapcsoló

gyors kioldás
gépezet
védőborítás

kerék rögzítő anyák



ajánlott kiegészítők

2 Ah - 28080
akkumulátor* 4 Ah - 28081
8 Ah - 28083

2,4 A - 28085
4,0 A - 28086



SHARE 20V
Li-ion technology

FESTA
POWER X TOOLS

AKKUMULÁTOROS SAROKCSISZOLÓ



*Az akkumulátor és a lemez nem tartozék

R.s. leírás

28030



4

SHARE 20V

sebesség
teher nélkül
8000 min⁻¹

tömeg
akkumulátor
nélkül
1,6 kg

maximális
vastagság
vágott anyag
15 mm

maximális
kerék átmérője
115 mm

ergonomikus gumírozott fogantyú a kényelmes és biztos fogásért

forgászár

biztosíték
működtető
kapcsoló

gyors kioldás
gépezet
védőborítás

kerék rögzítő anyák



ajánlott kiegészítők

2 Ah - 28080
akkumulátor* 4 Ah - 28081
8 Ah - 28083

2,4 A - 28085
4,0 A - 28086



SHARE 20V
Li-ion technology

FESTA
POWER X TOOLS

AKKUMULÁTOROS SAROKCSISZOLÓ



*Az akkumulátor és a lemez nem tartozék

R.s. leírás

28032



4

SHARE 20V

fordulat terhelés nélkül
10000 min⁻¹

tömeg akkumulátor nélkül
1 kg

különcség kerek
5 mm

átmérő kerek
125 mm

működtető kapcsoló

porgyűjtő zsák

szívás

tartólemez tépőzárral

SHARE 20V Li-ion technology

ajánlott kiegészítők

2 Ah - 28080

akkumulátor* 4 Ah - 28081

8 Ah - 28083

töltő*

2,4 A - 28085

4,0 A - 28086

FESTA
POWER X TOOLS

AKKUMULÁTOR ORBITÁLIS CSISZOLÓGÉP



*akkumulátor nem tartozék

R.s. leírás

28040



4

SHARE 20V

fordulat terhelés nélkül
5000-15000 min⁻¹

tömeg akkumulátor nélkül
1 kg

sebességszabályozás

szerszám rögzítő csap

cserekar és
szerszámreteszéssel

sebesség ellenőrzés

ergonomikus gumírozott fogantyú a kényelmes és biztos fogásért

SHARE 20V Li-ion technology

ajánlott kiegészítők

2 Ah - 28080

akkumulátor* 4 Ah - 28081

8 Ah - 28083

töltő*

2,4 A - 28085

4,0 A - 28086

FESTA
POWER X TOOLS

VEZETÉK NÉLKÜLI KÉSZÜLÉK TÖBBFUNKCIÓS



*akkumulátor nem tartozék

R.s. leírás

28045



4

SHARE
20V

ergonomikus gumírozott fogantyú
a kényelmes és biztos fogásért

üzemkapcsoló biztosíték

lemezborító

szög beállítás
hajlam
a vágásról
45-90 fok

kapcsolat
külső
szívás

bázis

tengely 16 mm

fordulat
terhelés nélkül
3650 min⁻¹

állítható
dőlésszög
a vágásról
45-90 fok

max. átmérő
kerekek
165 mm
(ø16 mm)

maximális
vágás
50 mm

* 90 fokos szögben
ø165 mm

skála
vágási mélység



forgászár

vágásmélység beállítása

SHARE
20V
Li-ion
technology

ajánlott kiegészítők

2 Ah - 28080

akkumulátor* 4 Ah - 28081

8 Ah - 28083

töltő*

2,4 A - 28085

4,0 A - 28086



FESTA
POWER X TOOLS

AKKUMULÁTOROS KÖRFŰRÉS

A készlet tartalma:

- körfűrész
- oldalsó vezető
- csavarkulcs
- fűrészlap ø 165 x 2,8/2,0 x 20 mm 24T (**22314**)



vezetősín



22314



SHARE
20V

a pengelöketek száma

0-2400 min⁻¹

tömeg
akkumulátor
nélkül
1,8 kg

max. szög
ferde vágás
45 degrees

max. cut
profile
acél: 6 mm
faipari: 80 mm

ajánlott kiegészítők

2 Ah - 28080

akkumulátor* 4 Ah - 28081

8 Ah - 28083

2,4 A - 28085

töltő*

4,0 A - 28086

SHARE
20V
Li-ion
technology

FESTA
POWER X TOOLS

AKKUS DEKOPÍRFÜRÉSZ



*akkumulátor nem tartozék

R.s. leírás

28050

ergonomikus gumírozott fogantyú
a kényelmes és biztos fogásért

biztosíték
működtető kapcsoló

előszcilláció
beállítás

LED

rúdzár

vezetősín

bázis

mancs
lejtőreteszelés

ferde a vágást

0°
45° 45°

SHARE
20V

fordulat
terhelés nélkül
0-3000 min⁻¹

tömeg
akkumulátor
nélkül
1,7 kg

max. vágási vastagság
Fa: 100 mm
Acél: 5 mm
alumínium / réz: 20 mm

ajánlott kiegészítők

2 Ah - 28080

akkumulátor* 4 Ah - 28081

8 Ah - 28083

2,4 A - 28085

töltő*

4,0 A - 28086

SHARE
20V
Li-ion
technology

FESTA
POWER X TOOLS

AKKUS DUGATTYÚS FÜRÉSZ



*akkumulátor nem tartozék

R.s. leírás

28055

biztosíték
működtető kapcsoló

ergonomikus gumírozott
fogantyú a kényelmes és
biztos fogásért

gyors kioldás
fűrészlap

SHARE
20V

max. nyomás
8,2 bar

nyomásmérő
**psi, bar,
kgf/cm², kPa**

tömlőt
600 mm

feszültség
20 V

háttérvilágítású
manométer kijelző



ergonomikus
gumírozott
fogantyú a
kényelmes és
biztos fogásért

gyorskioldó
tokmány a
gumiabroncsok
felfújásához

autó akkumulátor
adapter
3 m



adapterek

A készlet tartalma:
- kompresszor
- hálózati adapter az autó akkumulátoráról
- 3x felfújó adapter

tömlőt
Ø 10,5 x 600 mm

LED lámpa



ajánlott kiegészítők

SHARE
20V
Li-ion
technology

akkumulátor* 2 Ah - 28080
4 Ah - 28081
8 Ah - 28083

töltő* 2,4 A - 28085
4,0 A - 28086



FESTA
POWER X TOOLS

LÉGKOMPRESSZOR

*akkumulátor nem tartozék

R.s. leírás

28075

48013 **NEW** adapterek



1

1

NEW

vízszintes helyzetben 110 kg

függőleges helyzet 80 kg

Ø 220 mm

USB-C

USB - C

Li-ion technology

FESTA
POWER X TOOLS

ELEKTROMOS TAPADÓKORONG

Ø 220 mm	80 kg	110 kg	ROUGH SURFACE	USB-C	Li-ion 3.6V 2Ah
----------	-------	--------	---------------	-------	--------------------

R.sz. Leírás

36326

1

SHARE 20V

szívás kapacitás 60 kg

rezgés 12 beállítási fokozat, 3500 - 8500 r/min

súly 3 kg

feszültség 20 V

ergonomikus gumírozott fogantyú a kényelmes és biztos fogásért



megvilágított kijelző



reteszelő kar

tapadókorong Ø 125 mm



SHARE
20V
Li-ion technology

ajánlott kiegészítők

2 Ah - 28080
akkumulátor* 4 Ah - 28081
8 Ah - 28083
2,4 A - 28085
4,0 A - 28086
töltő*



A készlet tartalma:

- csempevibrátor
- akkumulátor 2,0 Ah (csak 36328)
- töltő (csak 36328)
- tok



FESTA
POWER X TOOLS

CSEMPEVIBRÁTOR

R.sz.	leírás	
36328	2Ah akkumulátorral és töltővel	1
36329	akkumulátor és töltő nélkül	1

**SHARE
20V**

állítható sebesség
0-8,7 mm/s

súly
1,7 kg

nyomaték
6500 N

feszültség
20 V



sima sebesség
beállítás

ergonomikus
gumírozott
fogantyú a
kényelmes és
biztos fogásért

LED lámpa



ajánlott kiegészítők

**SHARE
20V
Li-ion
technology**

akkumulátor* 2 Ah - 28080
4 Ah - 28081
8 Ah - 28083

töltő* 2,4 A - 28085
4,0 A - 28086



KINYOMÓ PISZTOLY

*akkumulátor nem tartozék

R.sz.	leírás
28060	



1



TARTALÉK HENGERES KARTUS TARTÓ

for 28060

R.sz.	leírás
28061	600 ml



600 ml



1

**SHARE
20V**

színhőmérséklet
5000 K

tömeg
akkumulátor nélkül
0,9 kg

fényáram
2000 lm (100%)

LED
teljesítmény
20W



**SHARE
20V
Li-ion
technology**

ajánlott kiegészítők

akkumulátor* 2 Ah - 28080
4 Ah - 28081
8 Ah - 28083

töltő* 2,4 A - 28085
4,0 A - 28086



a fényerősség beállítása
50%, 100%



360° forgófej beállítás



LED LÁMPA AKU

20W	2000 lumen	IP20	0.9 kg
-----	------------	------	--------

*akkumulátor nem tartozék

R.sz.	leírás
28065	



2

**SHARE
20V**

tuner
DAB+ / FM / BT

erő
2x 15 W

víz behatolással szembeni ellenállás
IP54

feszültség
20 V



USB 5V töltéshez



erő kínálat

**SHARE
20V**

FM antenna



színes kijelző

ajánlott kiegészítők

**SHARE
20V
Li-ion
technology**

akkumulátor* 2 Ah - 28080
 4 Ah - 28081
 8 Ah - 28083

töltő* 2,4 A - 28085
 4,0 A - 28086



AUX IN jack 3,5 mm



sztereó hangszórók

tápegység - 230V adapter



**FESTA
POWER X TOOLS**

RADIO DAB+ / FM / BT

- sztereó
- DAB+ / FM
- külső bemenet Bluetooth V5.0 / AUX IN 3,5 mm-es jack
- víz behatolással szembeni ellenállás IP54
- 30 előre beállított memória (30 DAB / 30 FM)
- USB a töltéshez
- 2,4" színes kijelző
- teljesítmény 2x 15 W
- 20 V / 1,3 A
- adapter

*akkumulátor nem tartozék

R.sz. leírás

28076



SHARE
20V



TÖLTŐ 20 V | 2,4 A

R.s. leírás
28085 220 – 240 V, 50 – 60 Hz, 70 W



20

SHARE
20V



TÖLTŐ 20 V | 4,0 A

R.s. leírás
28086 *220 – 240 V, 50 – 60 Hz, 105 W



20

SHARE *Li-ion technology*
20V



akkumulátor töltésjelző

AKKUMULÁTOR 20 V | 2,0 Ah



R.s. leírás
28080



20

SHARE *Li-ion technology*
20V



akkumulátor töltésjelző

AKKUMULÁTOR 20 V | 4,0 Ah



R.s. leírás
28081



20

SHARE *Li-ion technology*
20V



akkumulátor töltésjelző

AKKUMULÁTOR 20 V | 8,0 Ah



R.s. leírás
28083



20

NEW

SHARE
20V *Li-ion*
technology

28080



28085



FESTA
POWER X TOOLS

AKKUMULÁTOR SZETT TÁSKA KÉSZLETTEL 2+3

28080 - Akkumulátor akkumulátoros szerszámokhoz FESTA SHARE20V 2,0 Ah
28085 - Töltő FESTA SHARE20V 2,4 A

KEDVEZMÉNYES
ÁR

R.s. leírás

28090

1

SHARE
20V *Li-ion*
technology

28004
apród 628025
apród 9

37330

28030
apród 12**BRUSHLESS**

KEDVEZMÉNYES
ÁR
+INGYENES TÁSKA

FESTA
POWER X TOOLS

AKKUMULÁTOR SZETT TÁSKA KÉSZLETTEL 3+3

28004 - Akkus fúró kalapáccsal FESTA SHARE20V
28025 - Fúrókalapács Akkus FESTA SDS+ SHARE20V
28030 - Sarokcsiszoló Akkus FESTA "BRUSHLESS" SHARE20V 125 mm
28080 - Akkumulátor akkumulátoros szerszámokhoz FESTA SHARE20V 2,0 Ah
28081 - Akkumulátor akkumulátoros szerszámokhoz FESTA SHARE20V 4,0 Ah
28086 - Töltő FESTA SHARE20V 4,0 A

28080
apród 1828081
apród 1828086
apród 18

R.s. leírás

28102

1

BRUSHLESS **SHARE**
20V *Li-ion*
technology

28002
apród 5

37330

28030
apród 12

KEDVEZMÉNYES
ÁR
+INGYENES TÁSKA

FESTA
POWER X TOOLS

AKKUMULÁTOR SZETT TÁSKA KÉSZLETTEL 2+3

28002 - Akkus fúró kalapáccsal FESTA SHARE20V
28030 - Sarokcsiszoló Akkus FESTA "BRUSHLESS" SHARE20V 125 mm
28080 - Akkumulátor akkumulátoros szerszámokhoz FESTA SHARE20V 2,0 Ah
28081 - Akkumulátor akkumulátoros szerszámokhoz FESTA SHARE20V 4,0 Ah
28086 - Töltő FESTA SHARE20V 4,0 A

28080
apród 1828081
apród 1828086
apród 18

R.s. leírás

28103

1

**SHARE
20V**

**Li-ion
technology**

28004
apród 6

28032
apród 12

28055
apród 15

28035
apród 14

37330

28040
apród 13

**KEDVEZMÉNYES
ÁR
+INGYENES TÁSKA**

**FESTA
POWER X TOOLS**

AKKUMULÁTOR SZETT TÁSKA KÉSZLETTEL 5+3

- 28004 - Akkus fúró kalapáccsal FESTA SHARE20V
- 28032 - Akkus saroksiszoló FESTA SHARE20V 115 mm
- 28035 - Körfűrész Akkus FESTA SHARE20V 165 mm/d 16 mm
- 28040 - Excentrikus köszörű Akkus FESTA SHARE20V 125 mm 8 ott.
- 28055 - Akkus fűrész FESTA SHARE20V
- 28080 - Akkumulátor akkumulátoros szerszámokhoz FESTA SHARE20V 2,0 Ah
- 28081 - Akkumulátor akkumulátoros szerszámokhoz FESTA SHARE20V 4,0 Ah
- 28086 - Töltő FESTA SHARE20V 4,0 A



28080
apród 18



28081
apród 18



28086
apród 18



R.s. leírás

28101



1

**SHARE
20V**

**Li-ion
technology**

BRUSHLESS

28002
apród 5

28030
apród 12

28040
apród 13

BRUSHLESS

28055
apród 15

37330

28035
apród 14

**KEDVEZMÉNYES
ÁR
+INGYENES TÁSKA**

**FESTA
POWER X TOOLS**

AKKUMULÁTOR SZETT TÁSKA KÉSZLETTEL 5+3

- 28002 - Akkus fúró kalapáccsal FESTA SHARE20V
- 28030 - Saroksiszoló Akkus FESTA "BRUSHLESS" SHARE20V 125 mm
- 28035 - Körfűrész Akkus FESTA SHARE20V 165 mm/d 16 mm
- 28040 - Excentrikus köszörű Akkus FESTA SHARE20V 125 mm 8 ott.
- 28055 - Akkus fűrész FESTA SHARE20V
- 28080 - Akkumulátor akkumulátoros szerszámokhoz FESTA SHARE20V 2,0 Ah
- 28081 - Akkumulátor akkumulátoros szerszámokhoz FESTA SHARE20V 4,0 Ah
- 28086 - Töltő FESTA SHARE20V 4,0 A

28080
apród 18



28081
apród 18



28086
apród 18



R.s. leírás

28104



1

BRUSHLESS

a szerszám árammal működik
kefe nélküli DC motor

nyomaték



sebesség

választható irány
a forgás

tokmány

fúrás, ütvefúrás,
csavarozás

percenkénti löketség



fúrás, csavarozás

tömeg
akkumulátorral / nélkül

rögzítés módja



rögzítés módja



rögzítés módja



lemez excentricitása

a készülék vezérlése
jobb és bal kézhez

megfelel ennek a szabványnak



fényáram



fény irányszöge

maximális tüzelési
frekvencia**SHARE
20V**

az eszköz kompatibilis
mindkét Akkumulátorral

megfelelő típusú körmök



megfelelő típusú csatok

csiszolókorong
lyukakkal

maximális kerékátmérő



kerék átmérője

maximális vágási vastagság
anyaga: famaximális vágási vastagság
anyaga: acél

előszcillációs beállítás



fűrészrögzítés



a pengelöketek száma

ferde lehetőség
vágotta fűrészlap gyors
kioldása

a fűrész lengéseinek száma



LED világítás



akkumulátor-kapacitás



akkumulátor

töltési idő
akkumulátor

NEW

forgási sebesség
520 min⁻¹

BPM / Ütőenergia
0-4100 / 12 J

teljesítmény
1500 W

tokmány
SDS MAX



MAX ø beton - ø 40 mm



porgyűjtő adapter



mélységi stop

SDS MAX tokmány

rezgés csökkentő

ergonomikus gumírozott fogantyú a kényelmes és biztos fogásért



kiegészítő fogantyú



3.0m

FESTA
POWER X TOOLS

ÜTVEFÚRÓ SDS MAX

A készlet tartalma:

- ütvefúró
- oldalsó fogantyú
- nyomtáv mélység
- csavarkulcs
- műanyag tok
- tartalék szénkefék
- porgyűjtő adapter
- SDS MAX tartozékok:

ø 16 x 280 mm
| 18 x 320 mm

2db tartalék szénkefe

- 28229



230V ~ 50Hz	1500W	4100 bpm	520 min ⁻¹	12J	SDS MAX	3m RUBBER	6.8	MAX ø 40mm Concrete	
----------------	-------	----------	-----------------------	-----	---------	-----------	-----	------------------------	--

FESTA
POWER X TOOLS

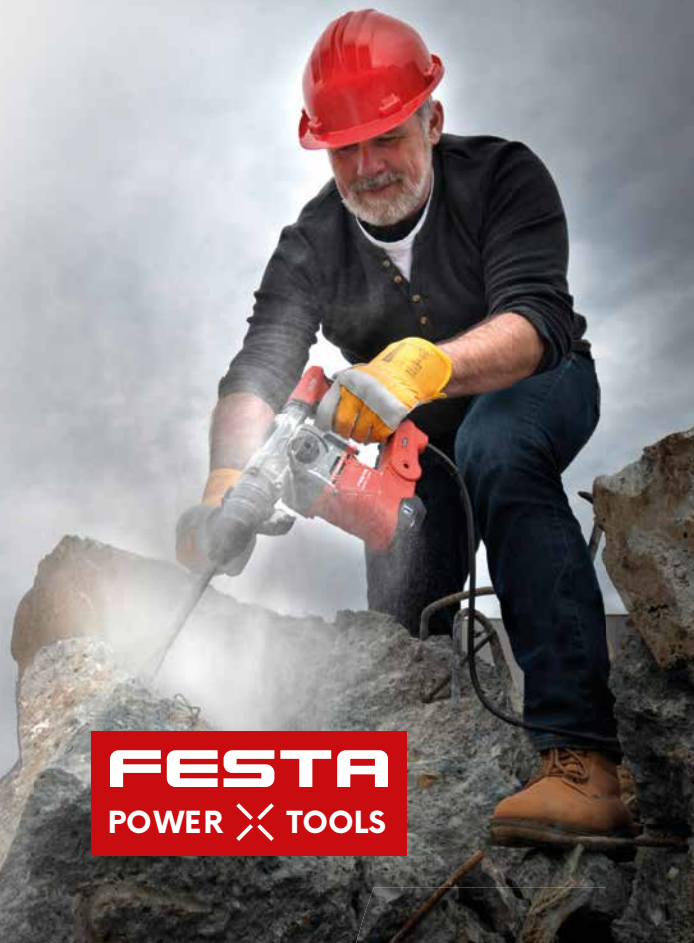

forgási sebesség
0-850 min⁻¹

BPM / Ütőenergia
0-4500 / 6 J

teljesítmény
1500 W

tokmány
SDS+



MAX Ø

beton - Ø 32 mm
fémek - Ø 13 mm
erdő - Ø 40 mm



mélységi stop

rezgéscsökkentés
rendszer

ergonomikus
gumírozott
fogantyú a
kényelmes és
biztos fogásért

SDS+
tokmány

kiegészítő fogantyú



2.0m

FESTA
POWER X TOOLS

ÜTVEFÚRÓ

A készlet tartalma:

- ütvefúró
- oldalsó fogantyú
- nyomtáv mélység
- csavarkulcs
- műanyag tok
- tartalék szénkefék
- SDS+ tartozékok:

Ø 8, 10, 12 x 160 mm

20 x 250 mm

14 x 250 mm



tartalék szén
ecsetek 2 db

- 28228



230V ~ 50Hz	1500W	0-4500 bpm	0-850 min ⁻¹	6J	SDS+	2m RUBBER	5.0
----------------	-------	------------	-------------------------	----	------	-----------	-----

R.sz. leírás
28225



forgási sebesség
0-1350 min⁻¹

BPM / Ütőenergia
0-5500 / 2,8 J

teljesítmény
800 W

tokmány
SDS+
ø 2 - 13 mm



MAX ø beton - ø 25 mm
fémek - ø 13 mm
erdő - ø 30 mm



FESTA
POWER X TOOLS

ÜTVEFÚRÓ

A készlet tartalma:

- ütvefúró
- oldalsó fogantyú
- nyomtáv mélység
- tokmány ø 2 - 13 mm
- műanyag tok
- vazelin
- tartalék szénkefék
- SDS+ tartozékok:

⚡ ø 6, 8, 10 x 160 mm

🔧 20 x 250 mm

🔧 14 x 250 mm



tartalék szén
ecsetek 2 db - 28223



forgási sebesség
0-4500 min⁻¹

súly
4,3 kg

teljesítmény
1400 W

max. átmérő
kerekek
max ø 185 mm / ø 20 mm



max. 63 mm



ergonomikus gumírozott fogantyú a kényelmes és biztos fogásért



max. 45°

Oldalsó megálló
6 - 120 mm



2.0m

porelszívás ø 35 mm

FESTA
POWER X TOOLS

KÖRFŰRÉS

A készlet tartalma:

- körfűrész
- oldalsó vezető
- csavarkulcs
- tartalék szénkefék
- fűrészlap ø 185 x 2,3/1,3 x 20 mm 24T (22316)



22316

1400W	230V ~ 50Hz	4500 min ⁻¹	ø 20 1 mm MAX 185mm	90° 63mm	45° 42mm	KG 4.3
-------	----------------	------------------------	---------------------------	-------------	-------------	-----------

tartalék szén
ecsetek 2 db - 28233



R.sz. leírás
28230

sebesség
teher nélkül
6600 min⁻¹

súly
5,8 kg

teljesítmény
2400 W

maximális
kerék átmérője
M14
max ø 230 mm



ergonomikus
gumírozott
fogantyú a
kényelmes és
biztos fogásért

SOFT START

Soft start rendszer



védőborítás



FESTA
POWER X TOOLS

SAROKCSISZOLÓ

A készlet tartalma:

- sarokcsiszoló
- védőburkolat
- oldalsó fogantyú
- csavarkulcs
- tartalék szénkefék



tartalék szén
ecsetek 2 db

- 28218



R.s. leírás

28215

2

sebesség
teher nélkül
11000 min⁻¹

súly
2 kg

teljesítmény
900 W

maximális
kerék átmérője
M14
max ø 125 mm

kiegészítő fogantyú



SOFT START
Soft start rendszer

működtető kapcsoló



védőborítás

3,0m

FESTA
POWER X TOOLS

SAROKCSISZOLÓ

- A készlet tartalma:
- sarokcsiszoló
 - védőburkolat
 - oldalsó fogantyú
 - csavarkulcs
 - tartalék szénkefék



900W	230V ~ 50Hz	11000min⁻¹	M14	max ø 125mm	2.0m RUBBER	KG 2.0				
-------------	-----------------------	------------------------------	------------	--------------------	--------------------	---------------	--	--	--	--

tartalék szén
ecsetek 2 db

- 28213



R.sz. leírás
28210

8

FESTA
POWER X TOOLS

TARTALÉK SZÉN ECSETEK

2x



R.sz.	leírás	
28229	alkalmas 28221	1
28228	alkalmas 28225	1
28223	alkalmas 28220	1
28233	alkalmas 28230	1
28213	alkalmas 28210	1
28218	alkalmas 28215	1



ADAPTER SDS MAX / SDS +



R.sz.	leírás	
20744		1



ADAPTER SDS+ / 1/2 UNF



R.sz.	leírás	
20745		1



FESTA

ADAPTER SDS + BIT 1/4"



R.sz.	leírás	
20743	75 mm	20



FESTA

SZORÍTÓ TOKMÁNY



R.sz.	leírás	
20960	1-13 mm + 2 klicse, 1/2 - 20 UNF	3
20966	náhradní klicsek	25



FESTA

GYORSBEFOGÓ TOKMÁNY



R.sz.	leírás	
20965	1,5 - 13 mm 1/2' - 20 UNF	1



GYORSBEFOGÓ TOKMÁNY



R.sz.	leírás	
20961	1,5 - 13 mm 1/2' - 20 UNF	1



TOLDAT 90° FÚRÓGÉPBE



R.sz.	leírás	
20365	Ø 1 - 10 mm	10



GYORSBEFOGÓ TOKMÁNY BITBEFOGÁSRA



R.sz.	leírás	
20963	Ø 1 - 6 mm	10



FESTA

PORELSZÍVÓ

R.sz.	leírás	
28267	max. 70 mm	1

FÚRÓSZÁR MEGVEZETŐ



R.sz.	leírás	
20379	Ø 4, 5, 6, 7, 8, 10, 12 mm	10

MŰSZAKI MŰSZAKI ADATOK



TERMÉKKATALÓGUS SZÁM	28000	28001	28002	28003	28004
Név	Akkus fúrókalapács	Akkus fúrókalapács	Akkus fúrókalapács	Akkus fúrókalapács	Akkus fúrókalapács
Sebesség terhelés nélkül	I.0-550 min ⁻¹ II.0-2000 min ⁻¹	I.0-550 min ⁻¹ II.0-2000 min ⁻¹	I.0-550 min ⁻¹ II.0-2000 min ⁻¹	I.0-500 min ⁻¹ II.0-1800 min ⁻¹	I.0-500 min ⁻¹ II.0-1800 min ⁻¹
Találatok száma	I.0-8800min ⁻¹ II.0-32000min ⁻¹	I.0-8800min ⁻¹ II.0-32000min ⁻¹	I.0-8800min ⁻¹ II.0-32000min ⁻¹	0-19200 min ⁻¹	0-19200 min ⁻¹
Az ütések száma					
Nyomaték	80 Nm	80 Nm	80 Nm	45 Nm	45 Nm
Max. akkumulátor voltage	20V	20V	20V	20V	20V
Nyomaték szakaszok száma	20+1+1	20+1+1	20+1+1	19+1+1	19+1+1
Szorítófej	2-13 mm	2-13 mm	2-13 mm	2-13 mm	2-13 mm
Súly akkumulátor nélkül	1,4kg	1,4kg	1,4kg	1,3kg	1,3kg
Borító	IPX0	IPX0	IPX0	IPX0	IPX0
Hangnyomás szint bizonytalanság K	LpA=97,04dB(A) K=5dB(A)	LpA=97,04dB(A) K=5dB(A)	LpA=97,04dB(A) K=5dB(A)	LpA=79dB(A) K=5dB(A)	LpA=79dB(A) K=5dB(A)
Hangteljesítmény szint bizonytalanság K	LwA=86,04dB(A) K=5dB(A)	LwA=86,04dB(A) K=5dB(A)	LwA=86,04dB(A) K=5dB(A)	LwA=90dB(A) K=5dB(A)	LwA=90dB(A) K=5dB(A)
Rezgés kalapálás nélkül a fémben	$\alpha_{h,D}=3,9m/s^2$ K=1,5m/s ²	$\alpha_{h,D}=3,9m/s^2$ K=1,5m/s ²	$\alpha_{h,D}=3,9m/s^2$ K=1,5m/s ²	$\alpha_{h,D}=2,4m/s^2$ K=1,5m/s ²	$\alpha_{h,D}=2,4m/s^2$ K=1,5m/s ²
Rezgés kalapálás nélkül betonba	$\alpha_{h,D}=11,4m/s^2$ K=1,5m/s ²	$\alpha_{h,D}=11,4m/s^2$ K=1,5m/s ²	$\alpha_{h,D}=11,4m/s^2$ K=1,5m/s ²	$\alpha_{h,D}=7,5m/s^2$ K=1,5m/s ²	$\alpha_{h,D}=7,5m/s^2$ K=1,5m/s ²
Maximális rezgés, bizonytalanság K					
Ütőerő					
Fúrás átmérője					
Rezgés a betonba - fő fogantyú					
Rezgés a betonban - kiegészítő fogantyú					
Csomag tartalma	fúró, 2,4 A töltő, akkumulátor 2.0 Ah, 4,0 Ah akkumulátor, kiegészítő fogantyú, bőrönd	fúró, töltő 2,4 A, akkumulátor 2.0 Ah, kiegészítő fogantyú, bőrönd	fúró	fúró, 2,4 A töltő, 2x 2,0 Ah akkumulátor, 6x bit, hordozó, 6x fúró, bőrönd	fúró



28005	28006	28007	28008	28021	28025
Fúró akkus csavarhúzó	Fúró akkus csavarhúzó	Fúró akkus csavarhúzó	Akkus csavarhúzó	Akkus ütvecsavarozó	Vezeték nélküli ütvefúró
I.0-350 min ⁻¹ II.0-1300 min ⁻¹	I.0-350 min ⁻¹ II.0-1300 min ⁻¹	I.0-350 min ⁻¹ II.0-1300 min ⁻¹	200 min ⁻¹	0-2000 min ⁻¹	I.0-300 min ⁻¹ II.0-1000 min ⁻¹
					0-5000bpm
				0-3000bpm	
28 Nm	28 Nm	20 Nm	3 Nm	150 Nm	
20V	20V	12V	3.6V	20V	20V
19+1	19+1	19+1	6+1		
1-10mm	1-10mm	1-10mm	1/4" hexagon	1/4" hexagon	SDS+
0,9kg	0,9kg	*1kg	*0,4kg	1,2kg	1,7kg
IPX0	IPX0	IPX0	IPX0	IPX0	IPX0
LpA=69dB(A) K=5dB(A)	LpA=69dB(A) K=5dB(A)	LpA=78dB(A) K=5dB(A)	LpA=58dB(A) K=3dB(A)	LpA=92dB(A) K=3dB(A)	LpA=82,98dB(A) K=3dB(A)
LwA=80dB(A) K=5dB(A)	LwA=80dB(A) K=5dB(A)	LwA=67dB(A) K=5dB(A)	LwA=69dB(A) K=3dB(A)	LwA=103dB(A) K=3dB(A)	LwA=93,98dB(A) K=3dB(A)
$\alpha_{h,D} < 1,9m/s^2$ K=1,5m/s ²	$\alpha_{h,D} < 1,9m/s^2$ K=1,5m/s ²	$\alpha_{h,D} = 2,1m/s^2$ K=1,5m/s ²			
$\alpha_{h,D} = 10,1m/s^2$ K=1,5m/s ²	$\alpha_{h,D} = 10,1m/s^2$ K=1,5m/s ²	$\alpha_{h,D} = 7,5m/s^2$ K=1,5m/s ²			
			$\alpha_h < 2,5m/s^2$ K=1,5m/s ²	$\alpha_{h,D} = 15,9m/s^2$ K=1,5m/s ²	
					1,2J
					Acél: 10mm concrete: 20mm Faipari: 20mm
					$\alpha_{h,(HD)} = 5,582m/s^2$ K=1,5m/s ²
					$\alpha_{h,(HD)} = 5,523m/s^2$ K=1,5m/s ²
fúró, 2,4 A töltő, 2x 2,0 Ah akkumulátor, 6x bit, hordozó, 6x fúró, bőrönd	fúró	fúró, 2,4 A töltő, 2x 1,5 Ah Akkumulátor, 6x bit, hordozó, 6x fúró, bőrönd	csavarhúzó, töltő 0,5 A, 1,5 Ah akkumulátor, 5x bit	szorító	fúrókalapács, kiegészítő fogantyú, mélységi megálló

* súly van feltüntetve akkumulátorral együtt

MŰSZAKI
MŰSZAKI ADATOK

TERMÉKKATALÓGUS SZÁM	28030	28032	28035	28040
Név	Vezeték nélküli szög őrlőgép	Akkus sarokcsiszoló	Vezeték nélküli kör alakú láttá	Akkumulátor orbitális csiszológép
Üresjárat sebesség	8500 min ⁻¹	8000 min ⁻¹	3650 min ⁻¹	10000 min ⁻¹
Terhelés nélküli kilengések száma				
Előre				
Az előlengés fokok száma				
A fűrészlap pengéinek száma				
Maximális vágott profil				
Maximális kerékátmérő	125 mm	115 mm		
Támogató lemez				125 mm
A körön 8 szívas lyuk				65 mm
A kerék excentricitása				5 mm
Orsó menet mérete	M14	M14		
A vágott anyag maximális vastagsága	15 mm	15 mm		
Max. akkumulátor feszültség	20V	20V	20V	20V
Állítható vágási szög			0-45°	
Vágja 45°-os szögben			35 mm	
Vágja 90°-os szögben			50 mm	
Oscillációs szög				
A delta köszörülés mérete				
Vibrációs sebességszabályozás				
A fűrészlap felszerelése				
A fűrészlap lökete				
Alaplap mérete			28 cm x 13,3 cm	
Súly akkumulátor nélkül	1,6kg	1,6kg	2,7kg	1kg
Kerék átmérője			165 mm	
Keréktest vastagsága			1,4 mm ± 5% mm	
A penge SK vastagsága			2,0 ± 5% mm	
Vágási szélesség			2,3 ± 5% mm	
A kerékfurat átmérője befogás után			16 mm	
Korongfogak száma			24	
Borító	IPX0	IPX0	IPX0	IPX0
Szeg-típusú, magasság x szélesség x vastagság				
Csatok feszítávja x magasság x szélesség x vastagság				
Max. körmök hossza / csíptető puha szőnyegekbe.				
Max. szögek hossza / klipek kemény mattba.				
Átlagos / max. felvételi gyakoriság				
Üzemidő (4 AH akkumulátor, teljesen feltöltve)				
Szög / kapocstár kapacitása				
Hangnyomás szint bizonytalanság K	LpA=87,1dB(A) K=3dB(A)	LpA=76,67dB(A) K=3dB(A)	LpA=84dB(A) K=3dB(A)	LpA=76dB(A) K=3dB(A)
Hangteljesítmény szint bizonytalanság K	LwA=98,1dB(A) K=3dB(A)	LwA=87,67dB(A) K=3dB(A)	LwA=95dB(A) K=3dB(A)	LwA=87dB(A) K=3dB(A)
Rezgés a felület csiszolásakor	$\alpha_{h,AG}=8,363m/s^2$ K=1,5m/s ²	$\alpha_{h,AG}=5,324m/s^2$ K=1,5m/s ²		
Rezgés a deszka vágásához				
Vibráció lemezvágáshoz				
Vibráció a vágáshoz Fa:en keretek				
Maximális rezgés, bizonytalanság K			$\alpha_h < 2,5m/s^2$ K=1,5m/s ²	$\alpha_h = 9,5m/s^2$ K=1,5m/s ²
Csomag tartalma	köszörű, kerékburkolat, kiegészítő fogantyú, csavarkulcs	köszörű, kerékburkolat, kiegészítő fogantyú, csavarkulcs	láttá, mélységi stop, fűrészlap	őrlőgép, porgyűjtő zsák



28045	28050	28055	28070
Vezeték nélküli készülék többfunkciós	Akkus dekopírfűrész	Akkus dugattyús fűrész	Akkus szegező és tűzőgép
5000-15000 min ⁻¹		0-3000 min ⁻¹	
		1°	
	3+0		
	0-2400 min ⁻¹		
	Acél: 6mm, Faipari: 80mm	Faipari: 100 mm, Acél: 5 mm, alumínium/réz: 20 mm	
20V		20V	20V
	ferde vágás max. 45 °		
3°			
90 mm			
lgen			
egyetemes		egyetemes	
		20 mm	
1kg	1,8kg	1,7kg	2,7kg
IPX0	IPX0	IPX0	IPX0
			F, 20-50mm x 1,2mm x 1,0 mm
			6,0mm x 19-40mm x 1,2mm x 1,0mm
			50 mm
			30 mm
			60/100 min ⁻¹
			1 óra
			100 darabok
LpA=78dB(A) K=3dB(A)	LpA=88,1dB(A) K=5dB(A)	LpA=87,33dB(A) K=5dB(A)	LpA=79,9dB(A) K=3dB(A)
LwA=89dB(A) K=3dB(A)	LwA=99,1dB(A) K=5dB(A)	LwA=98,33dB(A) K=5dB(A)	LwA=90,9dB(A) K=3dB(A)
	$\alpha_{h,B}=3,3m/s^2$ $K=1,5m/s^2$ $\alpha_{h,M}=4m/s^2$ $K=1,5m/s^2$	$\alpha_{h,B}=21,10m/s^2$ $K=1,5m/s^2$	
		$\alpha_{h,WB}=21,98m/s^2$ $K=1,5m/s^2$	
$\alpha_h=2,8m/s^2$ $K=1,5m/s^2$			$\alpha_h=1,39m/s^2$ $K=1,5m/s^2$
daráló, tartozékok (fűrész, kaparó, hordozó), 3x csiszolópapír P80	latta, Führungsschiene, szívás kötődés, 2x fűrészlap	fűrész, 2x fűrészlap	szegező / tűzőgép, 200x szög, 200x kapocs

MŰSZAKI
MŰSZAKI ADATOK

TERMÉKKATALÓGUS SZÁM	28075	36328	36329	28060	28076
Név	légkompresszor	csempevibrátor	csempevibrátor	kinyomó pisztoly	radio AKU DAB+ / FM / BT
Nyomásmérő	psi; bar; kgf/cm ² ; kPa				
Max. Nyomás	120 psi / 8,2 bar				
Tömlőt	∅ 10,5 x 600 mm				
Tapadókorong		∅ 123 mm	∅ 123 mm		
Szívás kapacitás		60 kg	60 kg		
Rezgés		12 beállítási fokozat, 3500 - 8500 r/min	12 beállítási fokozat, 3500 - 8500 r/min		
Nyomaték				6500 N	
Állítható sebesség				0 - 8,7 mm/s	
Úrtartalom				310 ml	
Tuner					DAB+ / FM
Külső bemenet					Bluetooth 5.0, aux IN jack 3,5 mm
Erő					2 x 15 W
Kijelző					színes 2,4"
Tápegység					adapter 230 V, akkumulátor Li-ion FESTA share 20 V
Előre beállított memória					30 (DAB+), 30 (FM)
Víz behatolással szembeni ellenállás					IPX54
Súly		3 kg	3 kg	1,7 kg	1,3kg
Feszültség	20 V	20 V	20 V	20 V	20 V
Csomag tartalma	kompresszor, hálózati adapter az autó akkumulá- toráról, 3x felfújó adapter	csempevibrátor, akkumulátor 2,0 Ah, töltő, tok	csempevibrátor, tok	kinyomó pisztoly	radio, adapter 230 V



TERMÉKKATALÓGUS SZÁM	28221	28225	28220	28230	28210	28215
Név	ütvefúró SDS MAX	ütvefúró SDS+	ütvefúró	körfűrész	sarokcsiszoló	sarokcsiszoló
Teljesítmény	1 500 W	1 500 W	800 W	1 400 W	900 W	2 400 W
Forgási sebesség	0 - 520 min-1	0 - 850 min-1	0 - 1 350 min-1	0 - 4 500 min-1	0 - 11 000 min-1	0 - 6 600 min-1
Bpm	0 - 4 100	0 - 4 500	0 - 5 500			
Ütőenergia	12 J	6 J	2,8 J			
Tokmány	SDS MAX	SDS+	SDS+ ø 2 - 13 mm	20 mm	M14 / 22,2 mm	M14 / 22,2 mm
Állítható vágási szög				0 - 45°		
Vágási mélység 45°				42 mm		
Vágási mélység 90°				63 mm		
Max. Átmérő kerek				185 mm	125 mm	230 mm
Súly	6,8 kg	5 kg	3,2 kg	4,3 kg	2 kg	5,8 kg
Tápkábel	3 m gumi	2 m gumi	2 m gumi	2 m műanyag	2 m gumi	2 m gumi
Csomag tartalma	ütvefúró, oldalsó fogantyú, nyomtáv mélység, csavarkulcs, műanyag tok, tartalék szénkefék, SDS MAX tartozékok: ♣ ø 16 x 280 mm 18 x 320 mm	ütvefúró, oldalsó fogantyú, nyomtáv mélység, csavarkulcs, műanyag tok, tartalék szénkefék, SDS+ tartozékok: ♣ ø 8, 10, 12 x 160 mm ↓ 20 x 250 mm 14 x 250 mm	ütvefúró, oldalsó fogantyú, nyomtáv mélység, tokmány ø 2 - 13 mm, műanyag tok, vazelin, tartalék szénkefék, SDS+ tartozékok: ♣ ø 6, 8, 10 x 160 mm ↓ 20 x 250 mm 14 x 250 mm	körfűrész, oldalsó vezető, csavarkulcs, tartalék szénkefék, fűrészlap ø 185 x 2,3/1,3 x 20 mm 24T	sarokcsiszoló, védőburkolat, oldalsó fogantyú, csavarkulcs, tartalék szénkefék	sarokcsiszoló, védőburkolat, oldalsó fogantyú, csavarkulcs, tartalék szénkefék

NEW

sebesség
teher nélkül
1000 - 1850 min⁻¹

hossz
110 - 180 cm

teljesítmény
750 W

kerék
átmérője
Ø 225 mm



ergonomikus
gumírozott
fogantyú a
kényelmes és
biztos fogásért



GIPSZKARTON CSISZOLÓ

230V ~ 50Hz	750W	1000-1850 min⁻¹	Ø 225mm	110-180 cm
LED	4 m	DRYWALL		



NEW



FESTA
POWER X TOOLS

PORSZÍVÓ 30L

230 V ~50 Hz **1600 W** **MAX 2000W** **82dB** **IPX4** **3m** **5m**

30L **WET** **DRY** **AUTO ON-OFF** **AUTOMATIC FILTER CLEANING** **HEPA**

R.sz.	Leírás	Mennyiség
28345		1
28346	HEPA filter	1

NEW



WEST BERG

PORSZÍVÓ 30L

230 V ~50 Hz **1200 W** **3m** **5m** **SEMI-AUTOMATIC FILTER CLEANING**

30L **WET** **DRY** **AUTO ON-OFF** **HEPA**

R.sz.	Leírás	Mennyiség
28340		1
28342	HEPA filter	1

FESTA
 POWER X TOOLS

**ELEKTROMOS
 HABARCSKEVERŐ DUPLA**

Bemenet	1800 W
Feszültség / frekvencia	230 V / 50 Hz
Fogaskerekek	2
1. fokozat (alapjárat sebesség)	0 - 450 ot./min.
2. fokozat (alapjárat sebesség)	0 - 790 ot./min.
Túltöltés elleni védelem	Igen
Keverőkosár átmérője	100 mm
Seprű hossza	570 mm
Súly	5,6 kg

Zn **CE**

R.sz.	leírás	
35311	keverő	1
35318	tartalék szén	1
35319	tartalék keverők - pár (L + R)	1

FESTA
 POWER X TOOLS

ELEKTROMOS HABARCS ÉS FESTÉKKEVERŐ 1600W

Teljesítmény:	1600 W
Hálózati feszültség:	230 V 50 Hz
Fokozatok száma:	2
1. Üresjárat fordulatszám:	0 - 480 ot./min.
2. Üresjárat fordulatszám:	0 - 800 ot./min.
Védelem:	Igen
Cérna:	M 14
Keverőlapát:	140 mm
Keverőlapát hossza:	600 mm
Tömeg:	4,7 kg

M14 **Zn** **CE**

R.sz.	leírás	
35310		1
35317	tartalék szén	1

FESTA
 POWER X TOOLS

ELEKTROMOS HABARCS ÉS FESTÉKKEVERŐ 850W

Teljesítmény:	850 W
Hálózati feszültség:	230 V 50 Hz
Fokozatok száma:	1
1. Üresjárat fordulatszám:	0 - 500 ot./min.
2. Üresjárat fordulatszám:	-
Védelem:	Igen
Cérna:	M 14
Keverőlapát:	120 mm
Keverőlapát hossza:	600 mm
Tömeg:	3,7 kg

M14 **Zn** **CE**

R.sz.	leírás	
35300		1
35316	tartalék szén	1



NEW

**WEST
BERG**

ELEKTROMOS HABARCS ÉS FESTÉKKEVERŐ 1600W

Teljesítmény:	1600 W
Hálózati feszültség:	230 V / 50 Hz
Fokozatok száma:	2
1. Üresjárat fordulatszám:	180 - 400 ot./min.
2. Üresjárat fordulatszám:	300 - 700 ot./min.
Védelem:	Igen
Cérna:	M 14
Keverőlapát:	140 mm
Keverőlapát hossza:	600 mm
Tömeg:	5,4 kg

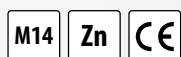

R.s.	leírás	
35305		1
35315	tartalék szén	1



NEW



FESTA
POWER X TOOLS

**NAGYNYOMÁSÚ
MOSÓ**

230 V ~50 Hz	1800 W	IPX5	MAX 7 l/min	MAX 140 bar	MAX 50°C	5m	AUTO STOP	7,8 kg
-----------------	-----------	------	-------------------	-------------------	-------------	----	--------------	-----------

R.s.	leírás
45271	



FESTA

**NAGYNYOMÁSÚ
MOSÓ**

230 V ~50 Hz	1500 W	MAX 120 bar	MAX 6 l/min	IPX5	5m	AUTO STOP
-----------------	-----------	-------------------	-------------------	------	----	--------------

R.s.	leírás
45270	nagynyomású mosó



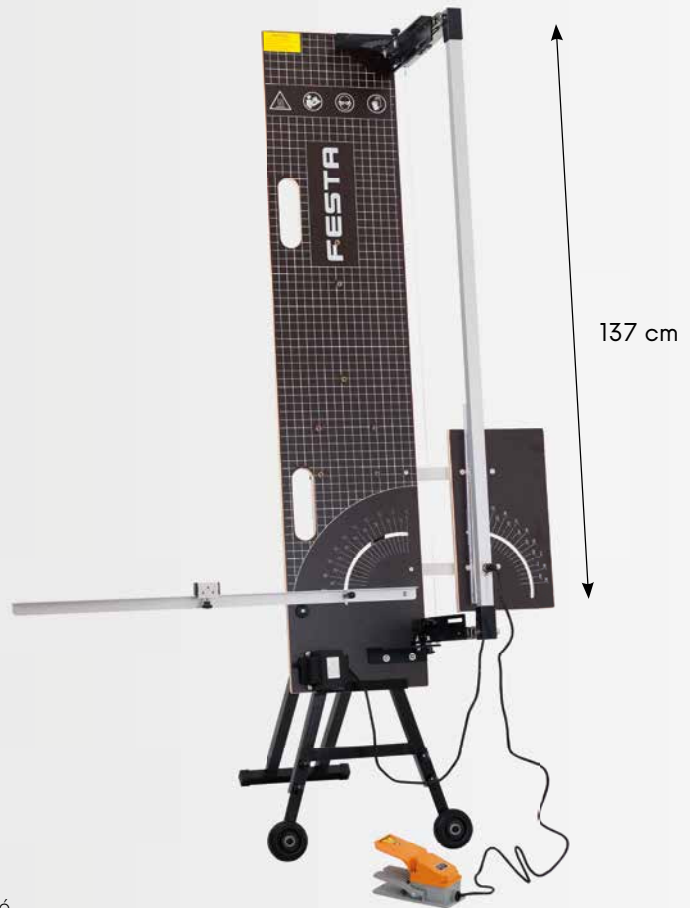
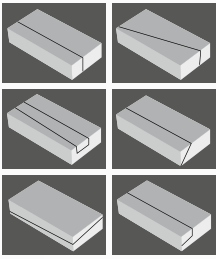

POLISZTIROL VÁGÓ

- tápfeszültség: 230 V/50 Hz
- teljesítmény: 200 W
- vágás hossz: 137 cm
- vágási vastagság: 35 cm
- Védettség: IP44
- Vágási szög: 0° - 90°

· felszerelés: állvány, lábkapcsoló, állványtartó, 2x Ni-Cr vágóhuzal, tisztító sárgarézes kefe, szerszámok és rögzítők, műanyag doboz kerekkel



R.s. Leírás

35348



1

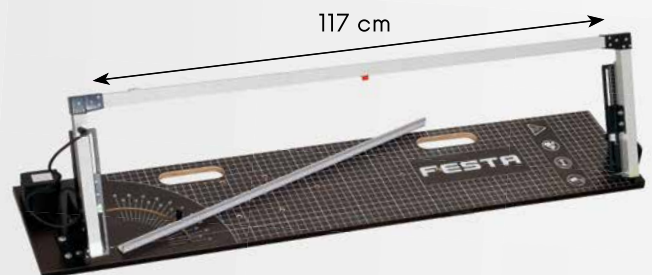
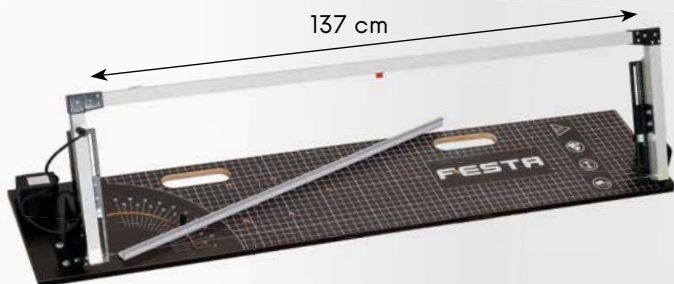
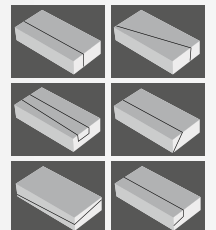
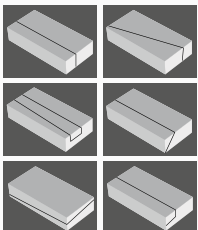

POLISZTIROL VÁGÓ

- tápfeszültség: 230 V / 50 Hz
- teljesítmény: 200 W
- vágás hossz: 137 cm
- vágási vastagság: 35 cm
- Védettség: IP44
- Vágási szög: 0° - 90°



· Felszereltség: Ni - Cr vágószál, tisztító rézkefe, imbusz

R.s. leírás

35345



1



POLISZTIROL VÁGÓ

- tápfeszültség: 230 V / 50 Hz
- teljesítmény: 160 W
- vágás hossz: 120 cm
- vágási vastagság: 35 cm
- Védettség: IP44
- Vágási szög: 0° - 90°



· Felszereltség: Ni - Cr vágószál, tisztító rézkefe, imbusz

R.s. leírás

35330



1



FESTA

POLISZTIROL VÁGÓ

- tápfeszültség: 230 V / 50 Hz
- teljesítmény: 160 W
- vágás hossz: 120 cm
- vágási vastagság: 52 cm
- Védettség: IP44
- Vágási szög: 0° - 90°



· Felszereltség: Ni - Cr vágószál, tisztító rézkefe, imbusz

R.sz. leírás
35344



FESTA

LÁBKAPCSOLÓ

· 35330, 35345, 35348 esetén

R.sz. leírás
35334



FESTA
ÁLLVÁNY

· 35330, 35345, 35348 esetén

R.sz. leírás
35336



FESTA

CSERERÚGÓ

· 35330, 35345, 35348 esetén

R.sz. leírás
35332



FESTA
ÁLLVÁNYTARTÓ

· 35330, 35345, 35348 esetén

R.sz. leírás
35333



FESTA

**TARTALÉK HÁLÓZATI ADAPTER
POLISZTIROL VÁGÓHOZ**

· 35330, 35345, 35348 esetén



feszültség/frekvencia:	230 V / 50Hz
Kimenet:	36 V / 5 A
erő:	200 W

R.sz. leírás
35347



**TARTALÉK FŰTŐSZÁL
NI-CR
POLISZTIROL VÁGÓHOZ**

R.sz. leírás
35331 117 cm
35346 137 cm





Li-ion
technology

FESTA
POWER X TOOLS

VEZETÉK NÉLKÜLI POLISZTIROL VÁGÓ

- akkumulátor 36 V, 1,5Ah Li-ion
- teljesítmény 180 W
- hőmérséklet max 350 C°
- penge hossz 20 cm
- felszerelés: 2 elem, töltő, penge, tisztító sárgaréz kefe, hatlapú



R.sz.	leírás	
35323	Elektromos porisztírol vágó	1
35328	pót penge 14 cm	1
35329	pót penge 25 cm	1



FESTA
POWER X TOOLS

ELEKTROMOS PORISZTIROL VÁGÓ

- tápfeszültség 230 V/50 Hz
- teljesítmény 250 W
- hőmérséklet 50-600 C°
- penge hossz 25 cm
- tápkábel hossza 3 m



· Felszereltség: tisztító rézkefe, imbusz, pengék 25 és 30 cm, tartó doboz

R.sz.	leírás	
35326	Elektromos porisztírol vágó	1
35328	pót penge 14 cm	1
35329	pót penge 25 cm	1

VEZETŐ SABLON

R.sz.	leírás	
35327	vezető sablon	1
35335	pót penge - 30 cm	1

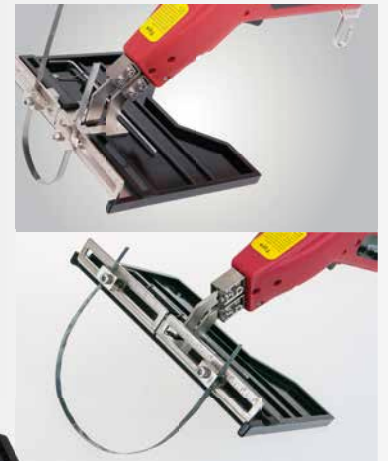

FESTA
POWER X TOOLS

ELEKTROMOS PORISZTIROL VÁGÓ



· temperature regulation

R.sz.	leírás	
35325	220 W	1





FESTA

INVERTERES HEGESZTŐ KÉSZÜLÉK TIG / MMA 160A

Tápfeszültség	230 V / 50 Hz
Üresjáratú feszültség	55 V
Hegesztőáram tartomány	10 - 160 A
Elektródák	1,5 - 4,0 mm
Munka ciklus	TIG- 160 A / 60%, MMA - 140 A / 60%
Védettség	IP 21
Hegesztés típusa	TIG/MMA
Méret	405 x 165 x 270 mm
Technology:	Anti-stick, Arc-force, Hot start, Litf TIG
Tömeg	6 kg



R.s. leírás
70040 Welding inverter TIG/MMA160A



1

FESTA



LCD display



FESTA

HEGESZTŐPAJZS ÖNSÖTÉTEDŐ

látómező mérete	98 x 80 mm
szűrő sötétedési sebessége	1/25 000 s
szűrő elsötétítése	DIN 5-8 / 9-13
UV / IR védelem	DIN 16
optikai osztály	1 1 1 2
érzékelők száma	4
tápegység	napelem + elem CR2450 celula solara + baterie CR2450
munkamód	Hegesztés, köszörülés

**CE EN
379**



R.s. leírás
70064 aktív 1
70066 csere borító üveg 1



**FESTA****HEGESZTŐPAJZS
ÖNSÖTÉDŐ CARBON**

R.s.	leírás	
70063	aktív	4

**HEGESZTŐPAJZS
ÖNSÖTÉDŐ**

R.s.	leírás	
70060	aktív	4

**HEGESZTŐPAJZS PASSZÍV**

R.s.	leírás	
70061		4

**HEGESZTŐPAJZS
ÜVEG****2x**

R.s.	leírás	
70065	113 x 80 mm	20

**HEGESZTŐSZEMÜVEG****UV-IR
protection**

R.s.	leírás	
70062		1

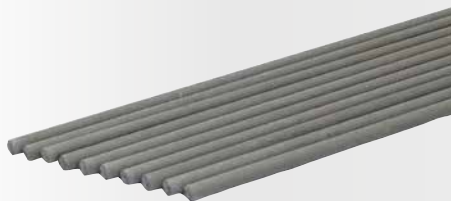
**RUTILELEKTRÓDA**

· hitelesített

R.s.	leírás	mnozsív	
70021	Ø 2,0 x 300 mm	10 db	1
70020	Ø 2,0 x 300 mm	2,5 kg	8
70026	Ø 2,5 x 300 mm	10 db	1
70025	Ø 2,5 x 300 mm	2,5 kg	8
70033	Ø 3,2 x 350 mm	10 db	1
70032	Ø 3,2 x 350 mm	5 kg	4

**BASICELEKTRÓDA**

· hitelesített

R.s.	leírás	mnozsív	
70030	Ø 2,0 x 300 mm	2,5 kg	1
70031	Ø 2,0 x 300 mm	5 kg	1
70035	Ø 2,5 x 300 mm	2,5 kg	8
70036	Ø 2,5 x 300 mm	10 db	1
70037	Ø 3,2 x 350 mm	5 kg	5

**HEGESZTŐ KALAPÁCS**

R.s.	leírás	
19115	320 g	1

**ELEKTRÓDA FOGÓ**

R.s.	leírás	
70070	300 A	1

**TEST FOGÓ**

R.s.	leírás	
70075	300 A	1



FESTA

SAROKMÁGNES



R.sz.	leírás	nosnost	
70096	150 x 130 x 30 mm · 45°, 90°, 135°	25 kg	10



SAROKMÁGNES



R.sz.	leírás	nosnost	
70090	85 x 85 mm · 45°, 90°	9 kg	10



SAROKMÁGNES



R.sz.	leírás	nosnost	
70093	95 x 64 mm · 30°, 45°, 60°, 75°, 90°	9 kg	10
70094	120 x 90 mm · 30°, 45°, 60°, 75°, 90°	18 kg	10
70095	137 x 110 mm · 30°, 45°, 60°, 75°, 90°	27 kg	10



SAROKMÁGNES



R.sz.	leírás	nosnost	
70091	95 x 109 x 25 mm · 45°, 90°, 135°	13 kg	10
70092	130 x 150 x 32 mm · 45°, 90°, 135°	22 kg	5



FESTA
POWER X TOOLS

CSŐ HEGESZTŐ

- tápfeszültség 230 V / 50 Hz
- teljesítmény 750 / 1500 W
- hőmérséklet 0-300 C°
- átmérők Ø 20,25,32,40,50,63 mm
- tömeg 1,6 kg



· a szerszámtartó tartalmaz mérőszalagot, vízmértéket, csavarhúzó, imbuszkulcs 6 hegesztő adapter, állvány, hordozó tok



R.sz.	
17182	1

FESTA
POWER X TOOLS

CSŐ HEGESZTŐ

- tápfeszültség 230 V / 50 Hz
- teljesítmény 800 / 1000 W
- hőmérséklet 0-300 C°
- átmérők Ø 16, 20, 25, 32 mm
- tömeg 1 kg



· a szerszámtartó tartalmaz imbusz kulcsot, 4 hegesztő adapter, állvány, hordozó tok



R.sz.	
17183	1

FESTA

OLAJMENTES KOMPRESSZOR 6 L



Tápegység	230 V 50Hz
Kibocsátás	1,2 kW (1,5HP)
Utántöltő kapacitása	6 l
Működési nyomás	8 Bar
sebesség	3900 min.
Szívóerő	180 l/min.
Szabad levegőellátás	116 l/min.
Súly	10 kg



R.s.
35360



OLAJMENTES KOMPRESSZOR 24 L



Kibocsátás	1100 W
Tápegység	230 V 50Hz
Terhelésmentes futás	2850 min-1
Működési nyomás	8 bar
Szabad levegőellátás	160 l min
Típus	Olajmentes legare gumatã
Utántöltő kapacitása	24 L
Súly	23 kg



R.s. leírás
35361 1,1 kW, 24 l



KOMPRESSZOR 24 L



Kibocsátás	1500 W
Tápegység	230 V 50Hz
Terhelésmentes futás	2850 min-1
Működési nyomás	8 bar
Szabad levegőellátás	200 l min
Típus	olajsav oleic
Utántöltő kapacitása	24 L
Súly	24 kg



R.s. leírás
35362 1,5 kW, 24 l



500 ml



600 ml



1000 ml

FESTA

SZORÓPISZTOLY, LEVEGŐS

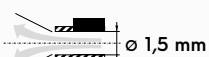

R.s. leírás
48020 felső

FESTA

SZORÓPISZTOLY, LEVEGŐS

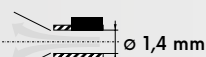

R.s. leírás
48021 felső
48047 Szórófej Ø 1,7 mm

FESTA

SZORÓPISZTOLY, LEVEGŐS



R.s. leírás
48022 felső
48046 Szórófej Ø 1,5 mm

FESTA

LEVEGŐPISZTOLY RÖVID



R.s. leírás
48030 dolní 1



SZÓRÓPISZTOLY FESTÉKHEZ ÉS VAKOLATOKHOZ

- 4 - 6 Bar
- 5 l
- Szórófej Ø 4; 6; 8 mm

R.s. leírás
48037 1



FESTA

LEVEGŐPISZTOLY

- 25 mm
- 90 mm
- 190 mm

R.s. leírás
48004 10



FESTA

LEVEGŐPISZTOLY RÖVID

R.s. leírás
48005 rövid 25



FESTA

LEVEGŐPISZTOLY KÖZEPES

R.s. leírás
48006 közepes 25



FESTA

LEVEGŐPISZTOLY HOSSZÚ

R.s. leírás
48007 hosszú 25



FESTA

OLAJPISZTOLY, LEVEGŐS

R.s. leírás
48015 spodní 1



FESTA

ÜREGELŐ PISZTOLY, LEVEGŐS

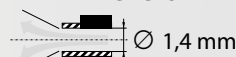

R.s. leírás
48036 spodní 1





30 cm

FESTA

LEVEGŐPISZTOLY NYOMÁSMÉRŐVEL

- 0 - 10 bar
- LCD display
- bar, kPa, Psi, kgf/cm²

2x AAA

R.s.	leírás	
48011	0 - 10 bar	10



FESTA

LEVEGŐPISZTOLY NYOMÁSMÉRŐVEL

R.s.	leírás	
48010		1



FESTA

KOMPRESSZOR KLT.

5x

- 1. olajpisztoly, levegős
- 2. levegőpisztoly nyomásmérővel
- 3. szorópisztoly, levegős
- 4. levegőpisztoly rövid
- 5. légtömlő csatlakozókkal

R.s.	leírás	
48001		1



FESTA

KOMPRESSZOR KLT.

3x

- 1. levegőpisztoly nyomásmérővel
- 2. levegőpisztoly rövid
- 3. légtömlő csatlakozókkal

R.s.	leírás	
48002		1

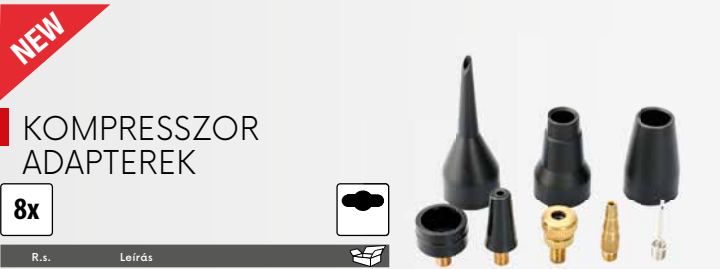

NEW

KOMPRESSZOR ADAPTEREK

8x

R.s.	leírás	
48013		1



FESTA

LÉGTÖMLŐ CSATLAKOZÓKKAL

R.s.	leírás	
48043	5 m 8 atm ø 10 mm	1



FESTA

LÉGTÖMLŐ CSATLAKOZÓKKAL

R.s.	leírás	
48040	5 m 8 atm ø 8 mm	1
48041	10 m 8 atm ø 8 mm	1
48042	15 m 8 atm ø 8 mm	1



FESTA

LÉGTÖMLŐ CSATLAKOZÓKKAL

R.s.	leírás	
48031	5 m ø 9/15 mm	1
48032	10 m ø 9/15 mm	1
48033	15 m ø 9/15 mm	1
48034	20 m ø 9/15 mm	1

FESTA

**VIZLEVÁLASZTÓ
KOMPRESSZORHOZ**

· max. nyomás **10 bar**



R.sz.	leírás	
48008	G 1/4'	1

FESTA

NYOMÁS SZABÁLYZÓ

· nyomás tartomány **0 - 10 bar**



R.sz.	leírás	
48009	G 1/4'	1

FESTA

TARTALÉK FÚVOKA

· mert 48021



R.sz.	leírás	
48047	Szórófej Ø 1,7 mm	1

FESTA

TARTALÉK FÚVOKA

· mert 48022

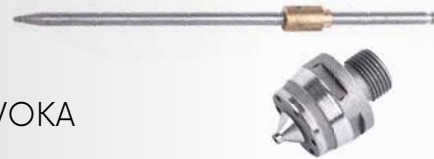

R.sz.	leírás	
48046	Szórófej Ø 1,5 mm	1

A WHITWORTHS CSŐSZÁLAK TÁBLÁJA

A SZÁLAK MÉRETE HÜVELYKBEN	MAX. A MENETEK KÜLSŐ Ø MM
1/8	9,728
1/4	13,157
3/8	16,662
1/2	20,955
3/4	26,441
1	33,249

CSAPCSATLAKOZÓ

R.sz.	leírás	
48075	1/4' külső	10
48076	3/8' külső	10
48077	1/2' külső	10
48095	1/4' belső	10
48096	3/8' belső	10
48097	1/2' belső	10

KÖZCSAVAR

R.sz.	leírás	
48050	1/4' külső x 1/4' külső	10
48051	1/4' külső x 3/8' külső	10

KÖZCSAVAR

R.sz.	leírás	
48054	3/8' külső x 1/4' belső	10
48055	1/2' külső x 3/8' belső	10
48056	3/8' külső x 1/2' belső	10
48057	1/4' külső x 3/8' belső	10

TÖMLŐBILINCS

R.sz.	leírás	
48085	1/4' - 6 mm	10
48086	3/8' - 9 mm	10
48087	1/2' - 13 mm	10

CSAPCSATLAKOZÓ

R.sz.	leírás	
48060	Ø 6 mm - 1/8' külső	10
48061	Ø 6 mm - 1/4' külső	10
48062	Ø 6 mm - 3/8' külső	10
48063	Ø 9 mm - 1/4' külső	10
48064	Ø 9 mm - 3/8' külső	10
48065	Ø 13 mm - 1/4' külső	10
48066	Ø 13 mm - 3/8' külső	10
48067	Ø 6 mm - 3/8' belső	10
48068	Ø 9 mm - 3/8' belső	10
48093	Ø 6 mm - 1/4' belső	10
48094	Ø 9 mm - 1/4' belső	10

CSAPCSATLAKOZÓ

R.sz.	leírás	
48080	1/4' külső	10
48081	3/8' külső	10
48090	3/8' belső	10
48091	1/4' belső	10

CSAPCSATLAKOZÓ

R.sz.	leírás	
48070	1/4' - 6 mm	10
48071	3/8' - 9 mm	10
48072	1/2' - 13 mm	10



FESTA
POWER X TOOLS

HŐLÉGFÚVÓ

feszültség	230V / 50Hz
energiateljesítmény	2000W
kapcsoló pozíciója	0 - I (350°C) - II (550°C)
kiegészítők	rozsdamentes 4 db



R.sz. leírás
35320 2000 W

1



FESTA
POWER X TOOLS

HŐLÉGFÚVÓ, SZABÁLYOZHATÓ

feszültség	230V 50Hz
energiateljesítmény	2000W
kapcsoló pozíciója	0 - I (50°C) - II (50 - 600°C)
levegőáramlás	120 - 500 l/min.
kiegészítők	rozsdamentes 4 db



R.sz. leírás
35322 2000 W

1

NEW



WEST BERG

FORRASZTÓ PISZTOLY

230V
~ 50Hz **175W**

R.sz. leírás

28275
28278 forrasztóhegy 3db



1

1



NEW



WEST BERG

FORRASZTÓPÁKA

230V
~ 50Hz **60W**

R.sz. leírás

28280
28282 forrasztóhegy 2db



1

1



FESTA
POWER X TOOLS

RAGASZTÓ PISZTOLY

· Ø ragasztó 11,2 mm

230V
~ 50Hz

80W

R.s. leírás

89975



20



NEW



FESTA
POWER X TOOLS

RAGASZTÓ PISZTOLY

· Ø ragasztó 7,2 mm

230V
~ 50Hz

12W

R.s. leírás

89775



1



RAGASZTÓ PISZTOLY

· Ø ragasztó 7,2 mm

230V
~ 50Hz

15W

R.s. leírás

89970



25



RAGASZTÓ PISZTOLY

· Ø ragasztó 11,2 mm

230V
~ 50Hz

60W

R.s. leírás

89973



20



OLVASZTÓ PÁLCIKA, ÁTLÁTSZÓ

R.s.	Ø	hossz	db	kg
89980	7,2 mm	100 mm	12 db	100
89988	7,2 mm	100 mm	1 kg	25



OLVASZTÓ PÁLCIKA, ÁTLÁTSZÓ

R.s.	Ø	hossz	db	kg
89985	11,2 mm	200 mm	10 db	50
89987	11,2 mm	200 mm	1 kg	25



OLVASZTÓ PÁLCIKA

R.s.	Ø	hossz	db	kg
89989	7,2 mm	100 mm	12 db	100
89990	11,2 mm	200 mm	10 db	50



ELEKTROMOS FŰTŐTEST

feszültség	230V ~50Hz
teljesítmény	3300W
Áramlási terhelés	14.5A
Teljesítménybeállítás	30/1650/3300W
Homérséklet tartomány	5-40°C
lefedettség	IP24
méretek	27 x 25.5 x 40cm
súly	4.8 kg

- Pincék, muhelyek, üzletek, party sátrak, üvegházak, stb. gyors és hatékony fűtésére
- Nem fogyaszt oxigént
- Biztonságos működés, folyamatos teljesítmény-szabályozás, térbeli termosztát, ventilátor
- Fűtőtest rozsdamentes acélból
- Nyári használatra szellőztetéshez, fűtés nélkül
- Alacsony zajszint
- Kiváló minőségű feldolgozás- és anyagok, robusztus acélszerkezet, könnyű és biztonságos kezelés, hosszú élettartam



R.sz.	leírás
35833	3,3 kW



1

GÁZMELEGÍTŐ

Gáz	G30-I3B/P
Gáznyomás	0.7bar
Névleges feszültség	230V 50Hz
Motorteljesítmény	25W
Maximális gázfogyasztás	1.11 kg/h
Maximális hoteljesítmény	15kW
Maximális forró levego mennyisége	300m ³ /h

- Gyors és hatékony fűtés az építési munkáknál, muhelyekben, stb.
- Oxigént fogyaszt!
- Közvetlen légfűtő kényszerkeringéssel - gyors hobevitel
- Biztonságos működés, folyamatos teljesítményszabályozás
- Termosztát és biztonsági szelep a túlmelegedés és gázszivárgás ellen
- Tartozékokkal együtt - szabályozó és bemeneti gázcső
- Kiváló minőségű feldolgozás- és anyagok, robusztus acélszerkezet, könnyű és biztonságos használat, hosszú élettartam



R.sz.	leírás
35845	15 kW



1

GÁZMELEGÍTŐ

Gáz	G30-i3b/p
Gáznyomás	1.5bar
Névleges feszültség	230V 50Hz
Motorteljesítmény	70W
Maximális gázfogyasztás	2.2kg/h
Maximális hoteljesítmény	30kW
Maximális forró levego mennyisége	750m ³ /h

- Gyors és hatékony fűtés az építési munkáknál, muhelyekben, stb.
- Oxigént fogyaszt!
- Közvetlen légfűtő kényszerkeringéssel - gyors hobevitel
- Biztonságos működés, folyamatos teljesítményszabályozás
- Termosztát és biztonsági szelep a túlmelegedés és gázszivárgás ellen
- Tartozékokkal együtt - szabályozó és bemeneti gázcső
- Kiváló minőségű feldolgozás- és anyagok, robusztus acélszerkezet, könnyű és biztonságos használat, hosszú élettartam



R.sz.	leírás
35850	30 kW



1



FESTA

LED LÁMPA



R.sz.	leírás	
37611		1



FESTA

LED LÁMPA

· max. magasság 180 cm



R.sz.	leírás	
37615	20 W	1
37616	2 x 20 W	1



NEW



FESTA
INDUSTRY

KÁBELDOB

- gumi - IP44
- H07RN-F3G - 2,5mm²
- Hőbiztosítókkal felszerelve
- 16 A max. / 3680 W max.
- 4 foglalat

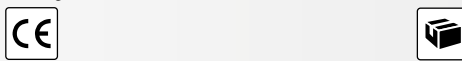

R.sz.	leírás	
37740	hossz 25 m, 2,5 mm ²	2
37741	hossz 50 m, 2,5 mm ²	2

NEW



FESTA
INDUSTRY

KÁBELDOB

- gumi - IP44
- H05RR-F3G - 1,5mm²
- Hőbiztosítókkal felszerelve
- 16 A max. / 3680 W max.
- 4 foglalat

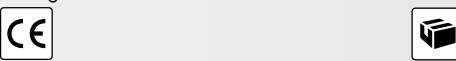

R.sz.	leírás	
37750	hossz 25 m, 1,5 mm ²	2
37751	hossz 50 m, 1,5 mm ²	2



FESTA

KÁBELDOB

- IP20
- H05VV - F3G 1,5mm²
- Hőbiztosítókkal felszerelve
- Max. megterhelés feltekert állapotban: 1000 W max.
- Max. megterhelés kihúzott állapotban: 3000 W max.
- 4 foglalat



R.sz.	leírás	
37760	hossz 25 m, 1,5 mm ²	2
37761	hossz 50 m, 1,5 mm ²	2

FESTA
INDUSTRY

HOSSZABBÍTÓ
KÁBEL

- gumi - IP44
- H07RN-F3G - 1,5mm²
- 16 A max. / 3680 W max.



R.sz.	leírás	
37744	hossz 5 m, 1,5 mm ²	8
37745	hossz 10 m, 1,5 mm ²	4
37746	hossz 20 m, 1,5 mm ²	8
37747	hossz 30 m, 1,5 mm ²	8

NEW

FESTA

HOSSZABBÍTÓ
KÁBEL

- IP20
- H05VV-F3G - 1,5mm²
- 16 A max. / 3680 W max.



R.sz.	leírás	
37730	hossz 10 m, 1,5 mm ²	8
37731	hossz 20 m, 1,5 mm ²	4
37732	NEW hossz 30 m, 1,5 mm ²	8
37733	NEW hossz 40 m, 1,5 mm ²	4





VÁGÓ ÉS CSISZOLÓ
ESZKÖZÖK

54 - 93



FESTA

CSIGAFÚRÓ FÉMHEZ HSS-COBALT 5%

Co 5%, W 6%
Mo 5%, Cr 4%, V 4%**HSS****DIN**
338**135°**

INOX

1400
MPa

R.s.	leírás		R.s.	leírás		R.s.	leírás	
22510	Ø 1,00 mm	1	22548	Ø 4,80 mm	1	22590	Ø 9,00 mm	1
22515	Ø 1,50 mm	1	22550	Ø 5,00 mm	1	22595	Ø 9,50 mm	1
22520	Ø 2,00 mm	1	22555	Ø 5,50 mm	1	22600	Ø 10,00 mm	1
22525	Ø 2,50 mm	1	22560	Ø 6,00 mm	1	22602	Ø 10,20 mm	1
22530	Ø 3,00 mm	1	22565	Ø 6,50 mm	1	22605	Ø 10,50 mm	1
22532	Ø 3,20 mm	1	22568	Ø 6,80 mm	1	22610	Ø 11,00 mm	1
22535	Ø 3,50 mm	1	22570	Ø 7,00 mm	1	22615	Ø 11,50 mm	1
22540	Ø 4,00 mm	1	22575	Ø 7,50 mm	1	22620	Ø 12,00 mm	1
22542	Ø 4,20 mm	1	22580	Ø 8,00 mm	1	22625	Ø 12,50 mm	1
22545	Ø 4,50 mm	1	22585	Ø 8,50 mm	1	22630	Ø 13,00 mm	1

FESTA

CSIGAFÚRÓ FÉMHEZ HSS-G W9

W 9%, Mo 3%
Cr 4%, V 1%**HSS****DIN**
338

INOX

1100
MPa

R.s.	leírás		R.s.	leírás		R.s.	leírás		R.s.	leírás	
19530	Ø 1,00 mm	10	19579	Ø 5,90 mm	5	19612	Ø 9,20 mm	5	19639	Ø 11,90 mm	3
19535	Ø 1,50 mm	10	19580	Ø 6,00 mm	5	19613	Ø 9,30 mm	5	19640	Ø 12,00 mm	3
19536	Ø 1,60 mm	10	19585	Ø 6,50 mm	5	19614	Ø 9,40 mm	5	19641	Ø 12,10 mm	3
19537	Ø 1,70 mm	10	19586	Ø 6,60 mm	5	19615	Ø 9,50 mm	3	19642	Ø 12,20 mm	3
19538	Ø 1,80 mm	10	19587	Ø 6,70 mm	5	19616	Ø 9,60 mm	3	19643	Ø 12,30 mm	3
19539	Ø 1,90 mm	10	19588	Ø 6,80 mm	5	19617	Ø 9,70 mm	3	19644	Ø 12,40 mm	3
19540	Ø 2,00 mm	10	19589	Ø 6,90 mm	5	19618	Ø 9,80 mm	3	19645	Ø 12,50 mm	3
19543	Ø 2,30 mm	10	19590	Ø 7,00 mm	5	19619	Ø 9,90 mm	3	19646	Ø 12,60 mm	1
19544	Ø 2,40 mm	10	19591	Ø 7,10 mm	5	19620	Ø 10,00 mm	3	19647	Ø 12,70 mm	1
19545	Ø 2,50 mm	10	19593	Ø 7,30 mm	5	19621	Ø 10,10 mm	3	19648	Ø 12,80 mm	1
19550	Ø 3,00 mm	10	19594	Ø 7,40 mm	5	19622	Ø 10,20 mm	3	19649	Ø 12,90 mm	1
19552	Ø 3,20 mm	10	19595	Ø 7,50 mm	5	19623	Ø 10,30 mm	3	19650	Ø 13,00 mm	1
19554	Ø 3,40 mm	10	19596	Ø 7,60 mm	5	19624	Ø 10,40 mm	3	19651	Ø 13,20 mm R13	1
19555	Ø 3,50 mm	10	19597	Ø 7,70 mm	5	19625	Ø 10,50 mm	3	19652	Ø 13,50 mm R13	1
19557	Ø 3,70 mm	10	19598	Ø 7,80 mm	5	19626	Ø 10,60 mm	3	19653	Ø 14,00 mm R13	1
19559	Ø 3,90 mm	10	19599	Ø 7,90 mm	5	19627	Ø 10,70 mm	3	19654	Ø 14,50 mm R13	1
19560	Ø 4,00 mm	10	19600	Ø 8,00 mm	5	19628	Ø 10,80 mm	3	19655	Ø 15,00 mm R13	1
19562	Ø 4,20 mm	10	19601	Ø 8,10 mm	5	19629	Ø 10,90 mm	3	19656	Ø 15,50 mm R13	1
19564	Ø 4,40 mm	10	19603	Ø 8,30 mm	5	19630	Ø 11,00 mm	3	19657	Ø 16,00 mm R13	1
19565	Ø 4,50 mm	10	19604	Ø 8,40 mm	5	19631	Ø 11,10 mm	3	19658	Ø 16,50 mm R13	1
19567	Ø 4,70 mm	10	19605	Ø 8,50 mm	5	19632	Ø 11,20 mm	3	19659	Ø 17,00 mm R13	1
19568	Ø 4,80 mm	10	19606	Ø 8,60 mm	5	19633	Ø 11,30 mm	3	19660	Ø 17,50 mm R13	1
19570	Ø 5,00 mm	5	19607	Ø 8,70 mm	5	19634	Ø 11,40 mm	3	19661	Ø 18,00 mm R13	1
19574	Ø 5,40 mm	5	19608	Ø 8,80 mm	5	19635	Ø 11,50 mm	3	19662	Ø 18,50 mm R13	1
19575	Ø 5,50 mm	5	19609	Ø 8,90 mm	5	19636	Ø 11,60 mm	3	19663	Ø 19,00 mm R13	1
19576	Ø 5,60 mm	5	19610	Ø 9,00 mm	5	19637	Ø 11,70 mm	3	19664	Ø 19,50 mm R13	1
19577	Ø 5,70 mm	5	19611	Ø 9,10 mm	5	19638	Ø 11,80 mm	3	19665	Ø 20,00 mm R13	1
19578	Ø 5,80 mm	5									

FESTA

CSIGAFÚRÓ ÁLLVÁNY HSS-G W9

W 9%, Mo 3%
Cr 4%, V 1%**HSS****DIN**
338

INOX

1100
MPa

R.s.	leírás	
19669		1
90191	fúrók nélkül	1



R.s.	a készlet tartalmát	R.s.	a készlet tartalmát
19530	Ø 1,00 mm 20x	19585	Ø 6,50 mm 15x
19535	Ø 1,50 mm 20x	19590	Ø 7,00 mm 15x
19540	Ø 2,00 mm 20x	19595	Ø 7,50 mm 15x
19545	Ø 2,50 mm 20x	19600	Ø 8,00 mm 15x
19550	Ø 3,00 mm 20x	19605	Ø 8,50 mm 15x
19552	Ø 3,20 mm 20x	19610	Ø 9,00 mm 15x
19555	Ø 3,50 mm 20x	19615	Ø 9,50 mm 15x
19558	Ø 3,80 mm 20x	19620	Ø 10,00 mm 15x
19560	Ø 4,00 mm 30x	19625	Ø 10,50 mm 6x
19562	Ø 4,20 mm 20x	19630	Ø 11,00 mm 6x
19565	Ø 4,50 mm 20x	19635	Ø 11,50 mm 6x
19568	Ø 4,80 mm 20x	19640	Ø 12,00 mm 6x
19570	Ø 5,00 mm 15x	19645	Ø 12,50 mm 6x
19575	Ø 5,50 mm 15x	19650	Ø 13,00 mm 6x
19580	Ø 6,00 mm 30x		

FESTA

CSIGAFÚRÓ FÉMHEZ HSS 4241

W 4%, Mo 3%
Cr 4%, V 1%

HSS

DIN
338



MOQ

R.s.	leírás		R.s.	leírás		R.s.	leírás		R.s.	leírás	
19670	Ø 0,6 mm	10	19703	Ø 4,0 mm	10	19736	Ø 7,3 mm	10	19769	Ø 10,6 mm	5
19671	Ø 0,8 mm	10	19704	Ø 4,1 mm	10	19737	Ø 7,4 mm	10	19770	Ø 10,7 mm	5
19672	Ø 0,9 mm	10	19705	Ø 4,2 mm	10	19738	Ø 7,5 mm	10	19771	Ø 10,8 mm	5
19673	Ø 1,0 mm	10	19706	Ø 4,3 mm	10	19739	Ø 7,6 mm	10	19772	Ø 11,0 mm	5
19674	Ø 1,1 mm	10	19707	Ø 4,4 mm	10	19740	Ø 7,7 mm	10	19773	Ø 11,2 mm	5
19675	Ø 1,2 mm	10	19708	Ø 4,5 mm	10	19741	Ø 7,8 mm	10	19774	Ø 11,3 mm	5
19676	Ø 1,3 mm	10	19709	Ø 4,6 mm	10	19742	Ø 7,9 mm	10	19775	Ø 11,4 mm	5
19677	Ø 1,4 mm	10	19710	Ø 4,7 mm	10	19743	Ø 8,0 mm	10	19776	Ø 11,5 mm	5
19678	Ø 1,5 mm	10	19711	Ø 4,8 mm	10	19744	Ø 8,1 mm	10	19777	Ø 11,6 mm	5
19679	Ø 1,6 mm	10	19712	Ø 4,9 mm	10	19745	Ø 8,2 mm	10	19778	Ø 11,7 mm	5
19680	Ø 1,7 mm	10	19713	Ø 5,0 mm	10	19746	Ø 8,3 mm	10	19779	Ø 11,8 mm	5
19681	Ø 1,8 mm	10	19714	Ø 5,1 mm	10	19747	Ø 8,4 mm	10	19780	Ø 11,9 mm	5
19682	Ø 1,9 mm	10	19715	Ø 5,2 mm	10	19748	Ø 8,5 mm	10	19781	Ø 12,0 mm	5
19683	Ø 2,0 mm	10	19716	Ø 5,3 mm	10	19749	Ø 8,6 mm	5	19782	Ø 12,2 mm	5
19684	Ø 2,1 mm	10	19717	Ø 5,4 mm	10	19750	Ø 8,7 mm	5	19783	Ø 12,5 mm	5
19685	Ø 2,2 mm	10	19718	Ø 5,5 mm	10	19751	Ø 8,8 mm	5	19784	Ø 12,8 mm	5
19686	Ø 2,3 mm	10	19719	Ø 5,6 mm	10	19752	Ø 8,9 mm	5	19785	Ø 12,9 mm	5
19687	Ø 2,4 mm	10	19720	Ø 5,7 mm	10	19753	Ø 9,0 mm	5	19786	Ø 13,0 mm	5
19688	Ø 2,5 mm	10	19721	Ø 5,8 mm	10	19754	Ø 9,1 mm	5	19787	Ø 13,2 mm R13	5
19689	Ø 2,6 mm	10	19722	Ø 5,9 mm	10	19755	Ø 9,2 mm	5	19788	Ø 13,5 mm R13	5
19690	Ø 2,7 mm	10	19723	Ø 6,0 mm	10	19756	Ø 9,3 mm	5	19789	Ø 14,0 mm R13	5
19691	Ø 2,8 mm	10	19724	Ø 6,1 mm	10	19757	Ø 9,4 mm	5	19790	Ø 14,5 mm R13	5
19692	Ø 2,9 mm	10	19725	Ø 6,2 mm	10	19758	Ø 9,5 mm	5	19791	Ø 15,0 mm R13	5
19693	Ø 3,0 mm	10	19726	Ø 6,3 mm	10	19759	Ø 9,6 mm	5	19792	Ø 15,5 mm R13	5
19694	Ø 3,1 mm	10	19727	Ø 6,4 mm	10	19760	Ø 9,7 mm	5	19793	Ø 16,0 mm R13	5
19695	Ø 3,2 mm	10	19728	Ø 6,5 mm	10	19761	Ø 9,8 mm	5	19794	Ø 16,5 mm R13	5
19696	Ø 3,3 mm	10	19729	Ø 6,6 mm	10	19762	Ø 9,9 mm	5	19795	Ø 17,0 mm R13	5
19697	Ø 3,4 mm	10	19730	Ø 6,7 mm	10	19763	Ø 10,0 mm	5	19796	Ø 17,5 mm R13	5
19698	Ø 3,5 mm	10	19731	Ø 6,8 mm	10	19764	Ø 10,1 mm	5	19797	Ø 18,0 mm R13	5
19699	Ø 3,6 mm	10	19732	Ø 6,9 mm	10	19765	Ø 10,2 mm	5	19798	Ø 18,5 mm R13	5
19700	Ø 3,7 mm	10	19733	Ø 7,0 mm	10	19766	Ø 10,3 mm	5	19799	Ø 19,0 mm R13	5
19701	Ø 3,8 mm	10	19734	Ø 7,1 mm	10	19767	Ø 10,4 mm	5	19800	Ø 19,5 mm R13	5
19702	Ø 3,9 mm	10	19735	Ø 7,2 mm	10	19768	Ø 10,5 mm	5	19801	Ø 20,0 mm R13	5

FESTA

CSIGAFÚRÓ ÁLLVÁNY HSS

W 4%, Mo 3%
Cr 4%, V 1%

HSS

DIN
338



R.s.	a készlet tartalmát	R.s.	a készlet tartalmát
19673	Ø 1,00 mm 20x	19728	Ø 6,50 mm 20x
19678	Ø 1,50 mm 20x	19733	Ø 7,00 mm 10x
19683	Ø 2,00 mm 20x	19738	Ø 7,50 mm 10x
19688	Ø 2,50 mm 20x	19743	Ø 8,00 mm 10x
19693	Ø 3,00 mm 30x	19748	Ø 8,50 mm 10x
19695	Ø 3,20 mm 30x	19753	Ø 9,00 mm 10x
19698	Ø 3,50 mm 30x	19758	Ø 9,50 mm 10x
19701	Ø 3,80 mm 30x	19763	Ø 10,00 mm 10x
19703	Ø 4,00 mm 30x	19768	Ø 10,50 mm 10x
19705	Ø 4,20 mm 30x	19772	Ø 11,00 mm 10x
19708	Ø 4,50 mm 30x	19776	Ø 11,50 mm 10x
19711	Ø 4,80 mm 30x	19781	Ø 12,00 mm 10x
19713	Ø 5,00 mm 20x	19783	Ø 12,50 mm 10x
19718	Ø 5,50 mm 20x	19786	Ø 13,00 mm 5x
19723	Ø 6,00 mm 20x		

FESTA

CSIGAFÚRÓ FÉMHEZ HSS

W 4%, Mo 3%
Cr 4%, V 1%

HSS

DIN
340



MOQ

R.s.	leírás		R.s.	leírás		R.s.	leírás	
20220	Ø 2,0 mm x 85 mm	1	20245	Ø 4,5 mm x 126 mm	1	20280	Ø 8,0 mm x 165 mm	1
20225	Ø 2,5 mm x 95 mm	1	20250	Ø 5,0 mm x 132 mm	1	20290	Ø 9,0 mm x 175 mm	1
20230	Ø 3,0 mm x 100 mm	1	20255	Ø 5,5 mm x 139 mm	1	20296	Ø 10,0 mm x 184 mm	1
20235	Ø 3,5 mm x 110 mm	1	20260	Ø 6,0 mm x 139 mm	1			
20240	Ø 4,0 mm x 119 mm	1	20270	Ø 7,0 mm x 156 mm	1			

HSS TITAN CSIGAFÚRÓ

* titanium surface to enhance performance and durability

TiN **HSS** **DIN 338**



R.sz.	leírás	
20400	Ø 1,0 mm	1
20401	Ø 1,5 mm	1
20402	Ø 2,0 mm	1
20403	Ø 2,5 mm	1
20404	Ø 3,0 mm	1
20405	Ø 3,2 mm	1
20406	Ø 3,5 mm	1
20407	Ø 3,8 mm	1
20408	Ø 4,0 mm	1
20409	Ø 4,2 mm	1
20410	Ø 4,5 mm	1

R.sz.	leírás	
20411	Ø 4,8 mm	1
20412	Ø 5,0 mm	1
20413	Ø 5,5 mm	1
20414	Ø 6,0 mm	1
20415	Ø 6,5 mm	1
20416	Ø 6,8 mm	1
20417	Ø 7,0 mm	1
20418	Ø 7,5 mm	1
20419	Ø 8,0 mm	1
20420	Ø 8,5 mm	1
20421	Ø 9,0 mm	1

R.sz.	leírás	
20422	Ø 9,5 mm	1
20423	Ø 10,0 mm	1
20424	Ø 10,2 mm	1
20425	Ø 10,5 mm	1
20426	Ø 11,0 mm	1
20427	Ø 11,5 mm	1
20428	Ø 12,0 mm	1
20429	Ø 12,5 mm	1
20430	Ø 13,0 mm	1

CSIGAFÚRÓ FÉMHEZ HSS

HSS **DIN 338**

ALU



R.sz.	leírás	
19841	Ø 4,1 mm 5 ks	10
19842	Ø 4,2 mm 5 ks	10
19845	Ø 4,5 mm 5 ks	10
19885	Ø 8,5 mm 1 ks	10
19895	Ø 9,5 mm 1 ks	10



FESTA

FÚRÓ KÉSZLET, INOX

W 9%, Mo 3%
Cr 4%, V 1% **HSS** **DIN 338**

13x



R.sz.	leírás	
20333	Ø 1,5 - 6,5 mm	20



FESTA

FÚRÓ KÉSZLET, INOX

W 9%, Mo 3%
Cr 4%, V 1% **HSS** **DIN 338**

19x



R.sz.	leírás	
20334	Ø 1,0 - 10,0 mm	20



FESTA

FÚRÓ KÉSZLET, INOX

W 9%, Mo 3%
Cr 4%, V 1% **HSS** **DIN 338**

25x



R.sz.	leírás	
20335	Ø 1,0 - 13,0 mm	5



FESTA

FÚRÓ KÉSZLET

W 4%, Mo 3%
Cr 4%, V 1% **HSS** **DIN 338**

13x



R.sz.	leírás	
20336	Ø 1,5 - 6,5 mm	1



FESTA

FÚRÓ KÉSZLET

W 4%, Mo 3%
Cr 4%, V 1% **HSS** **DIN 338**

19x



R.sz.	leírás	
20337	Ø 1,0 - 10,0 mm	20



FESTA

FÚRÓ KÉSZLET

W 4%, Mo 3%
Cr 4%, V 1% **HSS** **DIN 338**

25x



R.sz.	leírás	
20338	Ø 1,0 - 13,0 mm	10

FESTA

FÚRÓ KÉSZLET

TiN



9x

R.s. leírás
20317 Ø 5-6-8 mm



20



FESTA

FÚRÓ KÉSZLET

1/4" HSS

ALU

7x

R.s. leírás
20316 Ø 1,5-2-3-4-5-5,5-6 mm



20



FÚRÓ KÉSZLET

HSS DIN 338



19x

R.s. leírás
20305 Ø 1,0 - 13,0 mm

25



FÚRÓ KÉSZLET

HSS DIN 338



25x

R.s. leírás
20311 Ø 1,0 - 13,0 mm

10



FÚRÓ KÉSZLET

HSS DIN 338



13x

R.s. leírás
20300 Ø 1,5 - 6,5 mm

50



FÚRÓ KÉSZLET

HSS DIN 338



19x

R.s. leírás
20310 Ø 1 - 13 mm

10

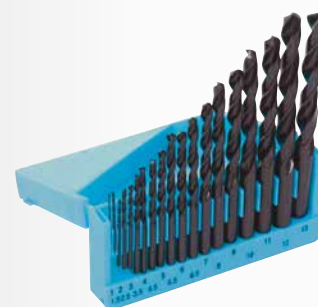

FÚRÓ KÉSZLET

fafúró	Ø 3 · 4 · 5 · 6 · 8 mm
fémfúró	Ø 1 · 1,5 · 2 · 2,5 · 3 · 3,5 · 4 · 4,5 · 5 · 5,5 · 6 · 7 · 8 · 10 mm
falazófúró	Ø 4 · 5 · 6 · 8 · 10 mm
lapos fafúró	Ø 16 · 22 · 25 mm
lyukfűrész	Ø 32 · 38 · 44 · 54 mm
mélységűtközők	Ø 6 · 8 · 10 mm
pontozó	
fúrósár átmérő mérő	

bit 25 mm	⊖ S	3 · 4 · 4 · 5 · 5 · 6 · 6 · 7
	⊕ PH	0 · 0 · 1 · 1 · 2 · 2 · 2 · 3 · 3
	⊗ PZ	0 · 0 · 1 · 1 · 2 · 2 · 2 · 3 · 3
	● H	2 · 2,5 · 3 · 3,5 · 4 · 5 · 6
bit 50 mm	⊖ S	4 · 5 · 6 · 6
	⊕ PH	1 · 2 · 2 · 3
	⊗ PZ	1 · 2 · 2 · 3

adapter sorjázó

bittartó

100x

R.s. leírás

20340



1



FÚRÓ KÉSZLET

HSS DIN 338



19x

R.s. leírás

20315 Ø 1 - 10 mm

10

FÚRÓ KÉSZLET

TiN HSS DIN 338



19x

R.s. leírás

20320 Ø 1 - 10 x 0,5 mm



30



FÚRÓ KÉSZLET

HSS DIN 338



19x

R.s. leírás

20321 Ø 1 - 10 x 0,5 mm



5



FÚRÓ ÉLEZŐ

R.s. leírás

20380 mert Ø 3,5 - 10 mm



20



FESTA

KORONÁS FÚRÓ BIMETAL



R.s.	leírás	
24419	Ø 19 mm	1
24420	Ø 20 mm	1
24422	Ø 22 mm	1
24425	Ø 25 mm	1
24429	Ø 29 mm	1
24432	Ø 32 mm	1
24435	Ø 35 mm	1
24437	Ø 37 mm	1
24444	Ø 44 mm	1
24451	Ø 51 mm	1
24457	Ø 57 mm	1
24464	Ø 64 mm	1
24468	NEW Ø 68 mm	1
24476	Ø 76 mm	1
24483	Ø 83 mm	1



FESTA

ADAPTER HSS-CO LYUKFÜRÉSZEZ

R.s. leírás

24410 mert lyukfűrészhez 14 - 30 mm



1



FESTA

ADAPTER HSS-CO LYUKFÜRÉSZEZ

R.s. leírás

24411 mert lyukfűrészhez 32 - 152 mm



1



FESTA

TARTALÉK FÚRÓ A LYUKFÜRÉSZ TARTÓHOZ

pro 24410, 24411

R.s. leírás

24412



5



FESTA

HSS KORONÁS FÚRÓ BIMETAL

HSS



9x

R.sz.	leírás	
24750	Ø 19, 22, 29, 38, 44, 57 mm	10



FESTA

HSS KORONÁS FÚRÓ BIMETAL

HSS



13x

R.sz.	leírás	
24751	Ø 19, 22, 29, 35, 38, 44, 51, 57, 64 mm	10



FESTA

HSS LÉPTETŐ FÚRÓSZÁR TITAN

TiN HSS



R.sz.	leírás	
20489	Ø 4 - 12 mm 9 steps	20
20490	Ø 4 - 20 mm 9 steps	10
20491	Ø 5 - 35 mm 13 steps	10
20492	Ø 7 - 40,5 mm 13 steps	5



FESTA

HSS LÉPTETŐ FÚRÓSZÁR TITAN

TiN HSS



3x

R.sz.	leírás	
20495	Ø 4 - 12, 4 - 20, 4 - 32 mm	1



HSS LÉPTETŐ FÚRÓSZÁR

HSS



R.sz.	leírás	
20487	Ø 4 - 20 mm 9 steps	10
20488	Ø 5 - 35 mm 13 steps	10
20494	Ø 4 - 32 mm 15 steps	10
20493	Ø 7 - 40,5 mm 13 steps	1



HSS LÉPTETŐ FÚRÓSZÁR

HSS



3x

R.sz.	leírás	
20496	Ø 4 - 12, 4 - 20, 4 - 32 mm	1



**FESTA**

TÖRTCSAVAR KISZEDŐ

Ø 4 mm Ø 11 mm
 Ø 4,5 mm Ø 15 mm
 Ø 6,5 mm Ø 19 mm
 Ø 7,5 mm Ø 24 mm

8x

R.s. leírás

20387



5



HAJTÓSZÁR RACSNIS

R.s. leírás

20397

M3 - M8



10

**FESTA**

TÖRTCSAVAR KISZEDŐ

Ø 4 mm
 Ø 4,5 mm
 Ø 6 mm
 Ø 7,5 mm
 Ø 11 mm

5x

R.s. leírás

20386



10



TÖRTCSAVAR KISZEDŐ

Ø 4 mm
 Ø 4,5 mm
 Ø 6 mm
 Ø 7,5 mm
 Ø 11 mm

5x

R.s. leírás

20385



10

**FESTA**

MENETVÁGÓ HAJTÓSZÁR

DIN 225

R.s. leírás

20396

25 x 9 mm



10

**FESTA**

MENETFÚRÓ HAJTÓSZÁR

DIN 1814

R.s. leírás

20394

M5 - M20

20395

1 - 1/2; M3 - M12



10

10

FESTA

MENETVÁGÓ ÉS FÚRÓ KLT.

32x

R.s. leírás

20391

M 3, 4, 5, 6, 8, 10, 12 mm



1

FESTA

MENETFÚRÓ KLT., FÉM DOBOZ

21x

R.s. leírás

20390

M 3, 4, 5, 6, 8, 10, 12 mm



1

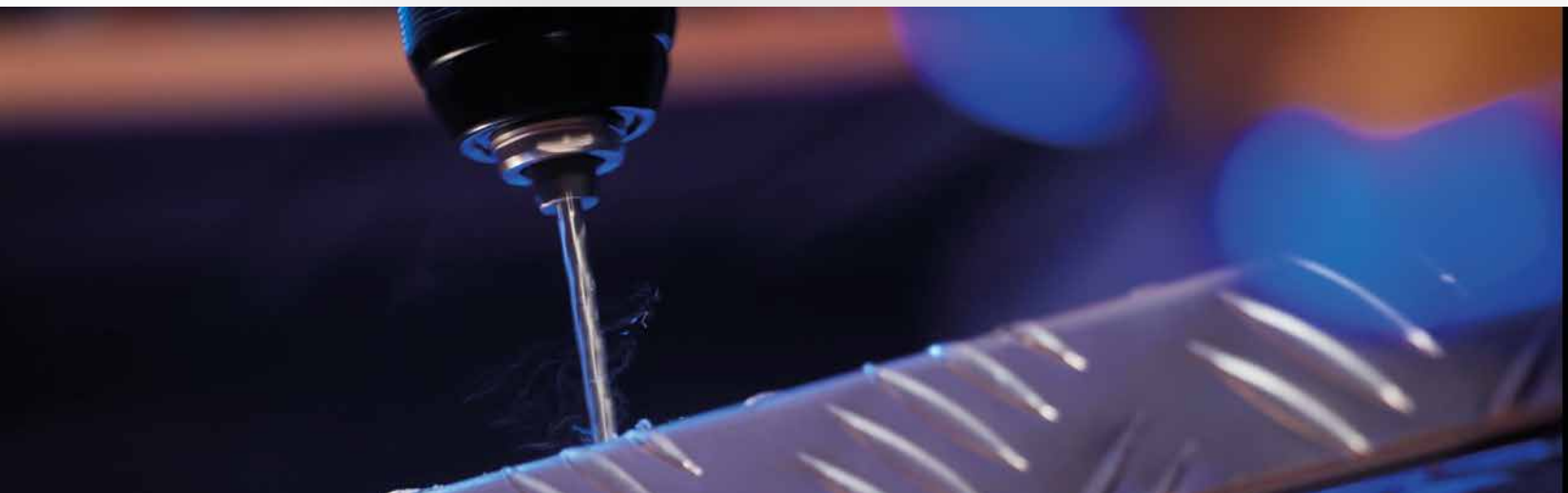

NEW

FESTA

FORSTNER FÚRÓ

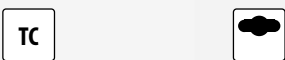

R.sz.	Leírás	
21531	Ø 15 mm	1
21532	Ø 20 mm	1
21533	Ø 25 mm	1
21534	Ø 30 mm	1
21535	Ø 35 mm	1
21536	Ø 40 mm	1



FESTA

FESTA

CSIGAFÚRÓ FÁHOZ



R.sz.	leírás	
20980	Ø 6 x 230 mm	1
20957	Ø 6 x 300 mm	1
20981	Ø 8 x 230 mm	1
20958	Ø 8 x 300 mm	1
20982	Ø 10 x 230 mm	1
20896	Ø 10 x 300 mm	1
20913	Ø 10 x 450 mm	1
20983	Ø 12 x 230 mm	1
20897	Ø 12 x 300 mm	1
20915	Ø 12 x 450 mm	1
20920	Ø 12 x 600 mm	1
20898	Ø 14 x 300 mm	1
20916	Ø 14 x 450 mm	1
20921	Ø 14 x 600 mm	1

R.sz.	leírás	
20984	Ø 16 x 230 mm	1
20899	Ø 16 x 300 mm	1
20917	Ø 16 x 450 mm	1
20922	Ø 16 x 600 mm	1
20918	Ø 18 x 450 mm	1
20923	Ø 18 x 600 mm	1
20919	Ø 20 x 450 mm	1
20924	Ø 20 x 600 mm	1
20724	Ø 22 x 450 mm	1
20725	Ø 24 x 450 mm	1
20726	Ø 26 x 450 mm	1
20727	Ø 28 x 450 mm	1
20728	Ø 30 x 450 mm	1

FESTA

CSIGAFÚRÓ FÁHOZ



5x

R.sz.	leírás	
20911	Ø 8, 10, 12, 14, 16 x 460 mm	10



FESTA

CSIGAFÚRÓ FÁHOZ



6x

R.sz.	leírás	
20912	Ø 6, 8, 10, 12, 16, 20 x 230 mm	10



FAFÚRÓ



R.sz.	leírás	
20729	Ø 6 x 400 mm	1
20731	Ø 8 x 400 mm	1
20736	Ø 8 x 600 mm	1
20730	Ø 10 x 400 mm	1
20737	Ø 10 x 600 mm	1



R.sz.	leírás	
20732	Ø 12 x 400 mm	1
20738	Ø 12 x 600 mm	1
20733	Ø 14 x 400 mm	1
20739	Ø 14 x 600 mm	1

R.sz.	leírás	
20734	Ø 16 x 400 mm	1
20740	Ø 16 x 600 mm	1
20735	Ø 18 x 400 mm	1
20741	Ø 18 x 600 mm	1

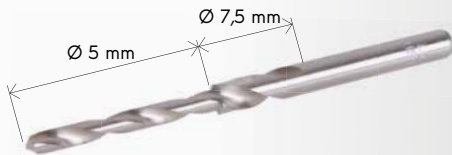
**FESTA**

FÚRÓ, MEGERŐSÍTÉSEKHEZ



R.s.	leírás	
20210	Ø 7,5, 5 mm	1



FÁFÚRÓ



R.s.	leírás	
21440	Ø 4 x 75 mm	1
21441	Ø 5 x 85 mm	1
21442	Ø 6 x 90 mm	1
21443	Ø 7 x 105 mm	1
21444	Ø 8 x 115 mm	1
21445	Ø 9 x 120 mm	1
21446	Ø 10 x 120 mm	1



MARÓ FÚRÓSZÁR



R.s.	leírás	
20460	Ø 6 mm	50



FÁFÚRÓ KÉSZLET



R.s.	leírás	
20910	8 db Ø 3, 4, 5, 6, 7, 8, 9, 10 mm	10
20905	5 db Ø 4, 5, 6, 8, 10 mm	10



PÁNTKIVETŐ KLT.



5x

R.s.	leírás	
21530	Ø 15, 20, 25, 30, 35 mm Ø 8 mm	20



MARÓ FÚRÓ-KÉSZLET



R.s.	leírás	
20450	Ø 3, 4, 5, 6, 6,5, 8 mm	20

HOMLOKMARÓ FÁFÚRÓ KLT.



6x

R.s.	leírás	
20901	Ø 10, 12, 16, 18, 20, 25 mm	20



20



KÉZIFÚRÓ KLT.

HOBBY

4x

R.s.	leírás	
20381	Ø 2, 3, 4, 5 mm	20





FESTA

KÖRKIVÁGÓ - KLT.

Ø 19 mm
 Ø 22 mm
 Ø 25,5 mm
 Ø 36 mm
 Ø 44 mm
 Ø 51 mm
 Ø 60 mm
 Ø 67 mm
 Ø 76 mm
 Ø 82 mm
 inbus
 2x fej



12x

R.s.	leírás	
24712	6 tpi	20



FESTA

KÖRKIVÁGÓ KLT.

Ø 64 mm
 Ø 73 mm
 Ø 89 mm
 Ø 102 mm
 Ø 127 mm

inbus
fej



8x

R.s.	leírás	
24706	6 tpi	20



FESTA

KORONA FÚRÓSZÁR ÁLLÍTHATÓ



R.s.	Leírás	
24415	Ø 19 - 127 mm max. hloubka 29 mm	6

FESTA

KÖRKIVÁGÓ FÁRA ÉS GIPSZKARTONRA



R.s.	leírás	
24715	1' Ø 67 mm 6 tpi	5
24713	1' Ø 73 mm 6 tpi	5
24714	1' Ø 102 mm 6 tpi	5
24720	1' Ø 152 mm 6 tpi	5



KÖRKIVÁGÓ - KLT.



R.s.	leírás	
24721	1' Ø 26, 32, 38, 45, 50, 56, 63 mm	10
24722	2' Ø 26, 32, 38, 45, 50, 56, 63 mm	10

KÖRKIVÁGÓ ÁLLÍTHATÓ



R.s.	leírás	
24716	Ø 30 - 120 mm	5



FESTA

PROFILMARÓ

M14



R.s.	leírás	
21807	Ø 30 mm / 60 mm	1

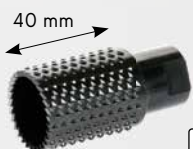

FESTA

PROFILMARÓ

M14



R.s.	leírás	
21808	Ø 30 mm / 105 mm	10





PROFILMARÓ KLT.

5x



1

R.s. leírás
21541 25



CSAPOSKŐ KLT.

5x

1

R.s. leírás
21540 Ø 3 mm, 6 mm 12

CSISZOLÓ KLT. FÚRÓBA



190x



R.s. leírás
24755 5

CSISZOLÓ KLT. FÚRÓBA



150x

10

R.s. leírás
24756 10



FÚRÓ-MARÓ KLT.



5x



R.s. leírás
21450 Ø 8 mm 10



FÚRÓ-MARÓ KLT.



12x

10

R.s. leírás
21451 Ø 8 mm 10



FÚRÓ-MARÓ KLT.



24x



R.s. leírás
21452 Ø 8 mm 1

FÚRÓ-MARÓ KLT.



35x



R.s. leírás
21453 Ø 8 mm 1



FÚRÓ-MARÓ KLT.



59x



R.s. leírás
21454 Ø 8 mm 1



FESTA

KÖZETFÚRÓ

DIN 8039



· Kétoldalas fúrófej



R.sz.	leírás	A mm	B mm	
20673	Ø 3 mm	60	30	100
20674	Ø 4 mm	75	40	100
20675	Ø 5 mm	85	50	100
20676	Ø 6 mm	100	60	100
20677	Ø 6 mm	200	160	50
20685	Ø 6 mm	300	260	50
20678	Ø 8 mm	120	75	50
20686	Ø 8 mm	200	155	50

R.sz.	leírás	A mm	B mm	
20687	Ø 8 mm	300	255	25
20688	Ø 8 mm	400	340	25
20680	Ø 10 mm	120	70	50
20690	Ø 10 mm	200	150	50
20691	Ø 10 mm	300	250	25
20692	Ø 10 mm	400	340	25
20682	Ø 12 mm	150	100	50
20694	Ø 12 mm	300	250	25

R.sz.	leírás	A mm	B mm	
20696	Ø 12 mm	400	340	25
20684	Ø 14 mm	150	90	25
	Befogás Ø 10 mm			
20697	Ø 14 mm	300	240	5
	Befogás Ø 10 mm			
20698	Ø 14 mm	400	340	15
	Befogás Ø 10 mm			

FESTA

KÖZETFÚRÓ SDS+

SDS+



· Kétoldalas fúrófej



R.sz.	leírás	A mm	B mm	
20855	Ø 14 mm	160	75	

25

FESTA

KÖZETFÚRÓ SDS+

SDS+

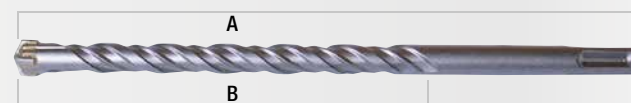

· négy fúrési bit, a teljesítmény és az élettartam növekedésével



R.sz.	leírás	A mm	B mm	
20748	Ø 6 mm	110	40	50
20749	Ø 6 mm	160	90	50
20750	Ø 6 mm	210	140	50
20751	Ø 6 mm	260	190	50
20861	Ø 6,5 mm	230	160	50
20862	Ø 6,5 mm	300	230	50
20752	Ø 8 mm	110	40	50
20753	Ø 8 mm	160	90	50
20754	Ø 8 mm	210	140	50
20755	Ø 8 mm	260	190	50
20825	Ø 8 mm	350	280	50
20756	Ø 10 mm	160	90	50
20757	Ø 10 mm	210	140	50
20758	Ø 10 mm	260	190	50
20759	Ø 10 mm	350	280	50
20760	Ø 10 mm	450	380	50
20761	Ø 10 mm	600	530	50
20762	Ø 10 mm	1000	930	50
20764	Ø 12 mm	160	80	50
20765	Ø 12 mm	210	130	50
20766	Ø 12 mm	260	180	50
20767	Ø 12 mm	350	270	50

R.sz.	leírás	A mm	B mm	
20768	Ø 12 mm	460	380	50
20769	Ø 12 mm	600	520	25
20770	Ø 12 mm	1000	920	25
20771	Ø 14 mm	160	80	25
20772	Ø 14 mm	260	180	25
20773	Ø 14 mm	350	270	25
20774	Ø 14 mm	460	380	25
20775	Ø 14 mm	600	520	25
20776	Ø 14 mm	1000	920	30
20777	Ø 16 mm	160	80	25
20778	Ø 16 mm	210	130	25
20779	Ø 16 mm	260	180	25
20780	Ø 16 mm	350	270	25
20781	Ø 16 mm	460	380	25
20782	Ø 16 mm	600	520	30
20783	Ø 16 mm	1000	920	25
20784	Ø 18 mm	260	180	25
20785	Ø 18 mm	450	370	25
20786	Ø 18 mm	600	520	32
20787	Ø 18 mm	1000	920	20
20788	Ø 20 mm	450	370	20
20789	Ø 20 mm	600	520	20

R.sz.	leírás	A mm	B mm	
20790	Ø 20 mm	800	720	25
20791	Ø 20 mm	1000	920	10
20792	Ø 22 mm	450	365	20
20793	Ø 22 mm	600	520	20
20794	Ø 22 mm	800	715	20
20795	Ø 22 mm	1000	920	10
20796	Ø 24 mm	450	365	10
20797	Ø 24 mm	600	520	20
20798	Ø 24 mm	800	715	10
20799	Ø 24 mm	1000	920	10
20870	Ø 26 mm	450	370	10
20871	Ø 26 mm	650	570	20
20872	Ø 26 mm	800	720	10
20873	Ø 26 mm	1000	920	10
20874	Ø 28 mm	450	365	10
20875	Ø 28 mm	600	565	20
20876	Ø 28 mm	800	715	10
20877	Ø 28 mm	1000	915	10
20878	Ø 30 mm	450	365	10
20879	Ø 30 mm	600	565	20
20880	Ø 30 mm	800	715	10
20881	Ø 30 mm	1000	915	10

FESTA

KÖZETFÚRÓ SDS MAX

SDS MAX

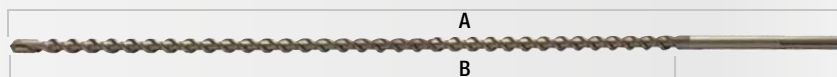

· négy fúrési bit, a teljesítmény és az élettartam növekedésével



R.sz.	leírás	A mm	B mm	
20508	Ø 16 mm	550	395	5
20510	Ø 18 mm	550	395	5
20520	Ø 18 mm	800	650	5
20511	Ø 20 mm	550	395	5
20521	Ø 20 mm	800	650	5

R.sz.	leírás	A mm	B mm	
20512	Ø 22 mm	550	395	5
20522	Ø 22 mm	800	650	5
20513	Ø 24 mm	550	395	5
20523	Ø 24 mm	800	650	5
20514	Ø 28 mm	550	395	5

R.sz.	leírás	A mm	B mm	
20524	Ø 28 mm	800	650	5
20515	Ø 30 mm	550	395	5
20525	Ø 30 mm	800	650	5
20516	Ø 40 mm	550	395	2
20526	Ø 40 mm	800	650	1

KÖZETFÚRÓ KÉSZLET SDS+

5x SDS+



R.sz.	leírás	
20890	Ø 5, 6, 8, 10, 12 mm 160 mm	25



KÖZETFÚRÓ KÉSZLET SDS+

6x SDS+



R.sz.	leírás	
20891	Ø 5, 6, 8 mm 110 mm Ø 8, 10, 12 mm 160 mm	25



FÚRÓKÉSZLET KÖRE

6x DIN 8039



R.sz.	leírás	
20895	Ø 5, 6, 8, 10, 12 mm	25



KÖZETFÚRÓ KÉSZLET



R.sz.	leírás	
20805	5 db Ø 4 - 10 mm	10
20820	8 db Ø 3 - 10 mm	10



FESTA

VÉSŐ KLT. SDS+

SDS+

4x



R.sz.	leírás	
20954	250 mm	1

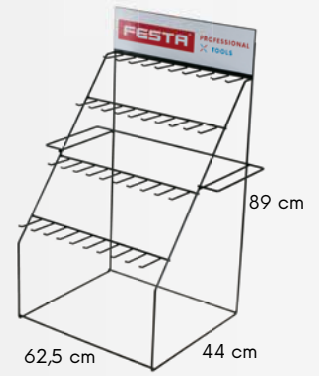

ÁLLVÁNY

R.sz.	leírás	
20999		1

FESTA

FÚRÓ ÉS VÉSŐ KLT. SDS+

- 2 x spicc véső
- 3 x lapos véső
- 12 x közetfúró Ø 5-12 mm

17x SDS+



R.sz.	leírás	
20952		1



FESTA

FÚRÓ ÉS VÉSŐ KLT. SDS+

- 1 x spicc véső 250 mm
- 1 x horonymaró 22 x 250 mm
- 1 x lapos véső 20 x 250 mm

- Ø 5 x 110 mm
- Ø 6 x 110 mm
- Ø 8 x 160 mm
- Ø 10 x 160 mm
- Ø 12 x 160 mm
- Ø 14 x 210 mm
- Ø 16 x 210 mm
- Ø 18 x 310 mm
- Ø 20 x 450 mm

12x SDS+



R.sz.	leírás	
20950		5



FESTA

LAPOS VÉSŐ SDS +

SDS+



R.sz.	leírás	
20996	250 x 100 mm	1



NEW



FESTA
LAPOS VÉSŐ SDS +

SDS+

R.sz.	leírás	
20997	445 x 130 mm	1

NEW



FESTA
LAPOS VÉSŐ SDS MAX

SDS MAX

R.sz.	leírás	
20932	450 x 100 mm	1

FESTA
LAPOS VÉSŐ 15° SDS +

SDS+

R.sz.	leírás	
20936	40 x 250 mm	5

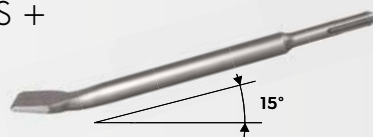

FESTA
LAPOS VÉSŐ SDS +

SDS+

R.sz.	leírás	
20948	20 x 250 mm	25
20990	20 x 400 mm	25
20949	40 x 250 mm	25
20991	40 x 400 mm	25



FESTA
LAPOS VÉSŐ SDS MAX

SDS MAX

R.sz.	leírás	
20940	25 x 280 mm	5
20941	40 x 280 mm	5
20942	75 x 280 mm	5
20943	25 x 400 mm	5
20944	40 x 400 mm	5
20945	25 x 600 mm	5
20946	50 x 600 mm	5



FESTA
SPICC VÉSŐ SDS MAX

SDS+

R.sz.	leírás	
20947	250 mm	25
20992	400 mm	25



FESTA
SPICC VÉSŐ SDS MAX

SDS MAX

R.sz.	leírás	
20937	Ø 18 x 280 mm	5
20938	Ø 18 x 400 mm	5
20939	Ø 18 x 600 mm	2



FESTA
HORONYMARÓ SDS+

SDS+

R.sz.	leírás	
20956	22 x 250 mm	25



FESTA
KORONA FÚRÓSZÁR SDS+

· fúrószár befogó adapter 24730, 24731 a 24732

SDS+

R.sz.	leírás	
24719	Ø 67 mm	1
24717	Ø 73 mm	1
24723	Ø 80 mm	1
24718	Ø 100 mm	1
24757	Ø 115 mm	1
24758	Ø 125 mm	1
24759	Ø 150 mm	1

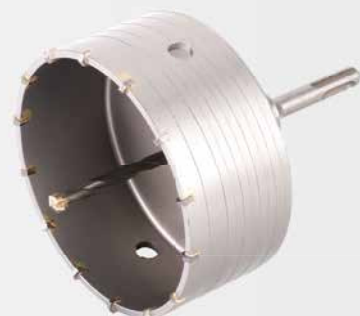

FESTA
FÚRÓSZÁR BEFOGÓ ADAPTER SDS MAX

SDS MAX

R.sz.	leírás	
24730	180 mm	1



FESTA
FÚRÓSZÁR BEFOGÓ ADAPTER SDS+

SDS+

R.sz.	leírás	
24731	300 mm	1
24732		1





FESTA

KÖRKIVÁGÓ KÉSZLET CSEMPÉRE



6x



R.sz.	leírás	
24745	Ø 33, 53, 67, 73 mm + hordozó, fúró	1

FESTA

KÖRKIVÁGÓ KÉSZLET CSEMPÉRE



8x

R.sz.	leírás	
24747	Ø 33, 53, 67, 73, 83 mm hordozó, fúró	1



FESTA

**KÖRKIVÁGÓ KÖR-
RONG CSEMPÉRE**

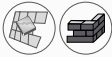

R.sz.	leírás	
24735	Ø 33 mm	1
24736	Ø 43 mm	1
24737	Ø 53 mm	1
24738	Ø 67 mm	1
24739	Ø 73 mm	1
24740	Ø 83 mm	1
24741	Ø 103 mm	1



FESTA

KÖRKIVÁGÓ KÉSZLET CSEMPÉRE

3x



R.sz.	leírás	
24746	Ø 103 mm + hordozó, fúró	1



FESTA

FÚRÓ



R.sz.	leírás	
24749		50



FESTA

HORDOZÓ



R.sz.	leírás	
24748	Ø 33 - 83 mm	10
24743	Ø 33 - 103 mm	10



FESTA

KÖRKIVÁGÓ - KARBID

· üvegre és kerámiára
· hűtés szükséges



R.sz.	leírás	
24770	Ø 4 mm	1
24771	Ø 6 mm	1
24772	Ø 8 mm	1
24773	Ø 10 mm	1
24774	Ø 12 mm	1



KÖRKIVÁGÓ

R.sz.	leírás	
24726	Ø 20-95mm	1



KÖRKIVÁGÓ

R.sz.	leírás	
24725	Ø 20-95mm	10



FESTA

SC KÖSZÖRŰ CSEMPÉRE



R.sz.	leírás	
22200	160 mm	20



FESTA

SC KÖSZÖRŰ CSEMPÉRE

· A téglá csiszolására



R.sz.	leírás	
22201	200 mm kettős érdesség	20





GYÉMÁNT KÖRKIVÁGÓ KLT.

- Ø 6 mm
- Ø 8 mm
- Ø 10 mm
- Ø 12 mm
- Ø 20 mm
- Ø 28 mm
- Ø 35 mm
- Ø 45 mm
- Ø 55 mm
- Ø 68 mm

vágótárcsa / csiszolótárcsa Ø 125 mm x 2,0 mm Ø 22,2 mm
 vágótárcsa Ø 125 mm x 1,2 mm Ø 22,2 mm
 gyémánt csiszoló korona Ø 0 - 50 mm
 gyémántcsiszoló szivacs 90 x 55 mm P60

13x M14



- Kerámia csempék
- Márvány
- Gránit



- nincs szükség vízhűtésre



R.sz. Leírás

24652

1



GYÉMÁNT KÖRKIVÁGÓ KLT.

- Ø 6 mm
- Ø 8 mm
- Ø 10 mm
- Ø 20 mm
- Ø 35 mm
- Ø 45 mm
- Ø 55 mm
- Ø 68 mm

8x M14



- Kerámia csempék
- Márvány
- Gránit



- nincs szükség vízhűtésre



R.sz. Leírás

24651

1



GYÉMÁNT CSISZOLÓ KORONA

M14



- Kerámia csempék
- Márvány
- Gránit



- nincs szükség vízhűtésre



R.sz. Leírás

24795 Ø 20 / 50 mm

1

24797 Ø 6 / 50 mm

1

24799 Ø 10 / 50 mm

1



GYÉMÁNT KÖRKIVÁGÓ

M14



- Kerámia csempék
- Márvány
- Gránit



- nincs szükség vízhűtésre



R.sz. Leírás

R.sz.	Leírás	
24620	Ø 6 mm	M14
24621	Ø 8 mm	M14
24622	Ø 10 mm	M14
24623	Ø 12 mm	M14
24624	Ø 14 mm	M14
24627	Ø 20 mm	M14
24630	Ø 28 mm	M14
24633	Ø 35 mm	M14
24636	Ø 45 mm	M14
24638	Ø 55 mm	M14
24640	Ø 68 mm	M14
24642	NEW Ø 72 mm	M14
24643	Ø 75 mm	M14



GYÉMÁNT CSISZOLÓ KORONA

M14



- Kerámia csempék
- Márvány
- Gránit



- nincs szükség vízhűtésre



R.sz. Leírás

24775 NEW Ø 2 - 35 mm

1

24777 Ø 2 - 75 mm

1

24778 Ø 2 - 50 mm

1



· Ø 2 mm - Ø 75 mm

FESTA
INDUSTRYGYÉMÁNT
CSISZOLÓ
KORONA

M14

- Kerámia csempék
- Márvány
- Gránit

- nincs szükség vízűtésre



· Ø 20 mm - Ø 48 mm



R.sz.	Leírás	1
24779	Ø 20 - 48 mm	1

FESTA
INDUSTRYGYÉMÁNT CSISZOLÓ
KORONA

M14

- Kerámia csempék
- Márvány
- Gránit

- nincs szükség vízűtésre



NEW

R.sz.	Leírás	1
24663	Ø 50 mm	1

FESTA

GYÉMÁNT KÖRKIVÁGÓ

M14

- Kerámia csempék
- Márvány
- Gránit

- nincs szükség vízűtésre



R.sz.	leírás	űchyt	1	R.sz.	leírás	űchyt	1
24760	Ø 6 mm	M14	1	24766	Ø 35 mm	M14	1
24761	Ø 8 mm	M14	1	24776	Ø 40 mm	M14	1
24762	Ø 10 mm	M14	1	24767	Ø 45 mm	M14	1
24763	Ø 12 mm	M14	1	24791	Ø 50 mm	M14	1
24764	Ø 14 mm	M14	1	24768	Ø 53 mm	M14	1
24670	Ø 16 mm	M14	1	24792	Ø 60 mm	M14	1
24671	Ø 18 mm	M14	1	24793	Ø 65 mm	M14	1
24790	Ø 20 mm	M14	1	24769	Ø 68 mm	M14	1
24672	Ø 22 mm	M14	1	24794	Ø 75 mm	M14	1
24673	Ø 25 mm	M14	1	24796	Ø 83 mm	M14	1
24765	Ø 28 mm	M14	1	24677	Ø102 mm	M14	1
24674	Ø 30 mm	M14	1	24676	Ø 110 mm	M14	1
24675	Ø 32 mm	M14	1	24678	Ø125 mm	M14	1

FESTA

GYÉMÁNT KÖRKIVÁGÓ

7x M14

- Kerámia csempék
- Márvány
- Gránit

- nincs szükség vízűtésre



R.sz.	Leírás	1
24650		1

FESTA

GYÉMÁNT KÖRKIVÁGÓ

- Kerámia csempék
- Márvány
- Gránit

- nincs szükség vízűtésre

R.sz.	leírás	1
24700	Ø 6 mm	1
24701	Ø 8 mm	1
24702	Ø 10 mm	1
24703	Ø 12 mm	1
24704	Ø 14 mm	1
24705	Ø 20 mm	1





FESTA

HÚSÍTÓ VIASZ
GYÉMÁNT
LYUKFŰRÉSHEZ

R.sz.	Leírás	
24710	30 ml	1



FESTA

GYÉMÁNT
KÖRKIVÁGÓ

6x

- Kerámia csempék
- Márvány
- Gránit

R.sz.	Leírás	
24798	Ø 6, 8, 10, 12, 14, 20 mm	1

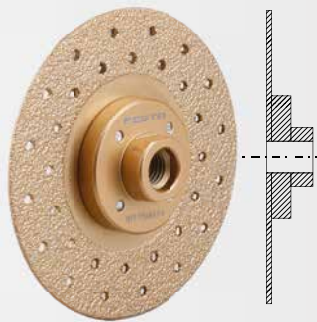

FESTA

GYÉMÁNT CSISZOLÓ
VÁGÓTÁRCSA

M14

- Kerámia csempék
- Márvány
- Gránit

nincs szükség vízhűtésre

R.sz.	Leírás	
24655	Ø 115 mm M14	1

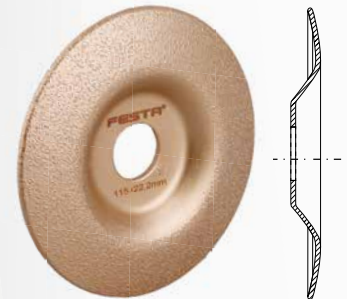

FESTA

GYÉMÁNT
CSISZOLÓ
VÁGÓTÁRCSA

- Kerámia csempék
- Márvány
- Gránit

nincs szükség vízhűtésre

R.sz.	Leírás	
24658	Ø 115 mm Ø 22,2 mm	1

FESTA

FURÓ ÜVEGHEZ ÉS KERÁMIÁHOZ

TiN 1/4"

-
-
-

R.sz.	Leírás	
24780	Ø 4 mm	40
24781	Ø 5 mm	40
24782	Ø 6 mm	40
24783	Ø 8 mm	40
24784	Ø 10 mm	40
24785	Ø 12 mm	40
24786	Ø 14 mm	1
24787	Ø 16 mm	1
24788	Ø 18 mm	1
24789	Ø 20 mm	1



FESTA

FURÓ ÜVEGHEZ ÉS
KERÁMIÁHOZ KLT.

- Ø 4 mm
- Ø 5 mm
- Ø 6 mm
- Ø 8 mm
- Ø 10 mm

5x

- Kerámia csempék
- Márvány
- Gránit

nincs szükség vízhűtésre

R.sz.	Leírás	
24734		1

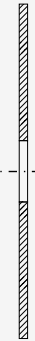

FESTA
 INDUSTRY

FESTA
 INDUSTRY

**GYÉMÁNT VÁGÓTÁRCSA /
 CSISZOLÓTÁRCSA**

- Kerámia csempék
- Márvány
- Gránit



- nincs szükség vízutésre

FESTA
 INDUSTRY

**GYÉMÁNT VÁGÓTÁRCSA
 TURBO EXTREME**

- Kerámia csempék
- Márvány
- Gránit



- nincs szükség vízutésre



R.sz.	leírás		
21230	Ø 115 mm x 1,8 mm	Ø 22,2 mm	1
21231	Ø 125 mm x 2,0 mm	Ø 22,2 mm	1

R.sz.	leírás		
21205	Ø 125 mm x 2,0 mm	Ø 22,2 mm	1
21209	Ø 230 mm x 2,6 mm	Ø 22,2 mm	1

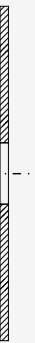
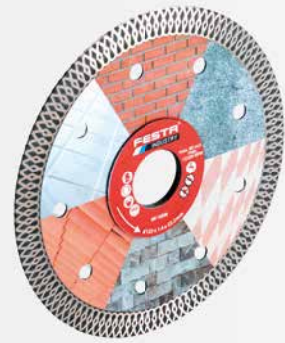
FESTA
 INDUSTRY

GYÉMÁNT VÁGÓTÁRCSA

- Kerámia csempék
- Márvány
- Gránit



- nincs szükség vízutésre



- Kerámia csempék
- Márvány
- Gránit



- nincs szükség vízutésre



R.sz.	leírás		
21234 NEW	Ø 115 mm x 1,2 x 8 mm	Ø 22,2 mm	1
21235	Ø 125 mm x 1,2 x 8 mm	Ø 22,2 mm	1
21238 NEW	Ø 200 mm x 1,6 x 11 mm	Ø 25,4 mm	1

R.sz.	leírás		
21200	Ø 115 mm 1,4 mm	Ø 22,2 mm	1
21201	Ø 125 mm 1,4 mm	Ø 22,2 mm	1
21204	Ø 200 mm 1,8 mm	Ø 25,4 mm	1
21203	Ø 230 mm 1,8 mm	Ø 22,2 mm	1

FESTA

GYÉMÁNT VÁGÓTÁRCSA SZEGMENTÁLT

R.sz.	leírás	
21311	Ø 115 mm Ø 22,2 mm	1
21312	Ø 125 mm Ø 22,2 mm	1
21315	Ø 150 mm Ø 22,2 mm	1
21318	Ø 180 mm Ø 22,2 mm	1
21323	Ø 230 mm Ø 22,2 mm	1
21324	Ø 300 mm Ø 25,4 mm	1
21327	Ø 350 mm Ø 25,4 mm	1
21326	Ø 400 mm Ø 25,4 mm	1

FESTA

TURBO GYÉMÁNT VÁGÓTÁRCSA

R.sz.	leírás	
21411	Ø 115 mm Ø 22,2 mm	1
21412	Ø 125 mm Ø 22,2 mm	1
21415	Ø 150 mm Ø 22,2 mm	1
21418	Ø 180 mm Ø 22,2 mm	1
21423	Ø 230 mm Ø 22,2 mm	1
21424	Ø 300 mm Ø 25,4 mm	1

FESTA

GYÉMÁNT VÁGÓTÁRCSA FOLYTONOS

R.sz.	leírás	
21210	Ø 110 mm Ø 22,2 mm	1
21211	Ø 115 mm Ø 22,2 mm	1
21212	Ø 125 mm Ø 22,2 mm	1
21215	Ø 150 mm Ø 22,2 mm	1
21218	Ø 180 mm Ø 22,2 mm	1
21219	Ø 180 mm Ø 25,4 mm	1
21220	Ø 200 mm Ø 25,4 mm	1
21223	Ø 230 mm Ø 22,2 mm	1
21224	Ø 300 mm Ø 25,4 mm	1

FESTA
INDUSTRY

GYÉMÁNT VÁGÓTÁRCSA SZEGMENTÁLT



R.sz.	leírás	
21301	Ø 125 mm Ø 22,2 mm 1,5 mm	1
21303	Ø 230 mm Ø 22,2 mm 1,8 mm	1

FESTA

TURBO GYÉMÁNT VÁGÓTÁRCSA



R.sz.	leírás	
21195	Ø 125 x 22,2 mm	1



6 mm



GYÉMÁNT VÁGÓTÁRCSA FOLYTONOS

R.sz.	leírás	
21010	Ø 110 mm Ø 22,2 mm	1
21011	Ø 115 mm Ø 22,2 mm	1
21012	Ø 125 mm Ø 22,2 mm	1
21015	Ø 150 mm Ø 22,2 mm	1
21018	Ø 180 mm Ø 22,2 mm	1
21023	Ø 230 mm Ø 22,2 mm	1



GYÉMÁNT VÁGÓTÁRCSA SZEGMENTÁLT

R.sz.	leírás	
21110	Ø 110 mm Ø 22,2 mm	1
21111	Ø 115 mm Ø 22,2 mm	1
21112	Ø 125 mm Ø 22,2 mm	1
21115	Ø 150 mm Ø 22,2 mm	1
21118	Ø 180 mm Ø 22,2 mm	1
21123	Ø 230 mm Ø 22,2 mm	1



GYÉMÁNT VÁGÓTÁRCSA TURBO

R.sz.	leírás	
21130	Ø 110 mm Ø 22,2 mm	1
21135	Ø 115 mm Ø 22,2 mm	1
21140	Ø 125 mm Ø 22,2 mm	1
21150	Ø 150 mm Ø 22,2 mm	1
21180	Ø 180 mm Ø 22,2 mm	1
21190	Ø 230 mm Ø 22,2 mm	1



FESTA

GYÉMÁNT
CSISZOLÓTÁRCSA



R.sz.	leírás		
21435	Ø 115 mm	Ø 22,2 mm	1
21436	Ø 125 mm	Ø 22,2 mm	1
21437	Ø 150 mm	Ø 22,2 mm	1



FESTA

GYÉMÁNT
CSISZOLÓTÁRCSA



R.sz.	leírás		
21430	Ø 115 mm	Ø 22,2 mm	1
21431	Ø 125 mm	Ø 22,2 mm	1
21432	Ø 150 mm	Ø 22,2 mm	1



FESTA

GYÉMÁNT
CSISZOLÓTÁRCSA



R.sz.	leírás		
21425	Ø 100 mm	Ø 22,2 mm	1
21426	Ø 115 mm	Ø 22,2 mm	1
21427	Ø 125 mm	Ø 22,2 mm	1
21428	Ø 150 mm	Ø 22,2 mm	1



FESTA
INDUSTRY

FÉMVÁGÓ
KORONG



R.sz.	leírás		
22258	Ø 115 mm	Ø 22,2 mm x 0,8 mm	25
22260	Ø 115 mm	Ø 22,2 mm x 1 mm	25
22263	Ø 115 mm	Ø 22,2 mm x 1,6 mm	25
22264	Ø 115 mm	Ø 22,2 mm x 2 mm	25
22259	Ø 125 mm	Ø 22,2 mm x 0,8 mm	25
22266	Ø 125 mm	Ø 22,2 mm x 1 mm	25
22269	Ø 125 mm	Ø 22,2 mm x 1,6 mm	25
22270	Ø 125 mm	Ø 22,2 mm x 2 mm	25
22273	Ø 150 mm	Ø 22,2 mm x 1,6 mm	25
22274	Ø 150 mm	Ø 22,2 mm x 2 mm	25
22275	Ø 150 mm	Ø 22,2 mm x 2,5 mm	25
22277	Ø 180 mm	Ø 22,2 mm x 2 mm	25
22280	Ø 230 mm	Ø 22,2 mm x 2 mm	25
22281	Ø 230 mm	Ø 22,2 mm x 2,5 mm	25

FESTA
INDUSTRY

VÁGÓKORONG
ALUMÍNIUM
ANYAGOKRA



R.sz.	leírás		
22285	Ø 115 mm	Ø 22,2 mm x 1 mm	1
22286	Ø 125 mm	Ø 22,2 mm x 1 mm	1

FESTA
INDUSTRY

KÖVÁGÓ KORONG



R.sz.	leírás		
22294	Ø 230 mm	Ø 22,2 mm x 3 mm	1

FESTA FÉMVÁGÓ KORONG



R.sz.	leírás	
22211	Ø 115 mm Ø 22,2 mm x 1 mm	INOX 50
22212	Ø 115 mm Ø 22,2 mm x 1,2 mm	INOX 50
22225	Ø 125 mm Ø 22,2 mm x 1 mm	INOX 50
22217	Ø 125 mm Ø 22,2 mm x 1,2 mm	INOX 50

FESTA FÉMVÁGÓ KORONG

10x



R.sz.	leírás	
22228	Ø 115 mm Ø 22,2 mm x 1 mm	INOX 1
22229	Ø 125 mm Ø 22,2 mm x 1,2 mm	INOX 1

FESTA FÉMVÁGÓ KORONG



R.sz.	leírás	
22251	Ø 115 mm Ø 22,2 mm x 1,6 mm	50
22215	Ø 115 mm Ø 22,2 mm x 2 mm	50
22216	Ø 115 mm Ø 22,2 mm x 2,5 mm	50
22252	Ø 125 mm Ø 22,2 mm x 1,6 mm	25
22218	Ø 125 mm Ø 22,2 mm x 2,5 mm	25
22219	Ø 150 mm Ø 22,2 mm x 1,2 mm	25
22253	Ø 150 mm Ø 22,2 mm x 1,6 mm	50
22220	Ø 150 mm Ø 22,2 mm x 2,5 mm	50
22254	Ø 180 mm Ø 22,2 mm x 1,6 mm	50
22222	Ø 180 mm Ø 22,2 mm x 2,5 mm	25
22255	Ø 230 mm Ø 22,2 mm x 1,6 mm	25
22224	Ø 230 mm Ø 22,2 mm x 2,5 mm	25

FESTA FÉMTISZTÍTÓ KORONG



R.sz.	leírás	
22240	Ø 115 mm Ø 22,2 mm x 6,4 mm	25
22242	Ø 125 mm Ø 22,2 mm x 6,4 mm	25
22244	Ø 150 mm Ø 22,2 mm x 6,4 mm	25
22246	Ø 180 mm Ø 22,2 mm x 6,4 mm	25
22248	Ø 230 mm Ø 22,2 mm x 6,4 mm	25

FESTA GYÉMÁNT VÁGÓTÁRCSA SZEGMENTÁLT



R.sz.	leírás	
21306	Ø 125 mm Ø 22,2 mm 1,3 mm	1
21308	Ø 230 mm Ø 22,2 mm 1,8 mm	1

FESTA KŐVÁGÓ KORONG



R.sz.	leírás	
22230	Ø 115 mm Ø 22,2 mm x 2,5 mm	50
22232	Ø 125 mm Ø 22,2 mm x 2,5 mm	50
22234	Ø 150 mm Ø 22,2 mm x 2,5 mm	25
22236	Ø 180 mm Ø 22,2 mm x 2,5 mm	25
22238	Ø 230 mm Ø 22,2 mm x 2,5 mm	25

FESTA VÁGÓTÁRCSA SZEGMENTÁLT KARBID



R.sz.	leírás	
21192	Ø 125 mm Ø 22,2 mm	1
21194	Ø 230 mm Ø 22,2 mm	1

FESTA
FAFORGÁCSOLÓ KORONG



R.s. leírás
21806 Ø 125 mm Ø 22,2 mm 1

FESTA
FAFORGÁCSOLÓ KORONG KÖZEPESEN DURVA



R.s. leírás
21802 Ø 125 mm Ø 22,2 mm 3 mm 10

FESTA
FAFORGÁCSOLÓ KORONG DURVA



R.s. leírás
21801 Ø 125 mm Ø 22,2 mm 3 mm 10

FESTA
CSISZOLÓ ÉS VÁGÓ KORONG



R.s. leírás
21803 Ø 125 mm Ø 22,2 mm 1

NEW
FESTA
CSISZOLÓ ÉS VÁGÓ KORONG



R.s. leírás
21805 Ø 125 mm Ø 22,2 mm 1



FESTA
FA CSISZOLÓ KORONG



R.s. leírás
21800 Ø 125 mm Ø 22,2 mm 1

Csiszolókorong fa csiszolásához

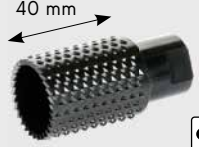
FESTA
PROFILMARÓ M14



R.s. leírás
21807 Ø 30 mm / 60 mm 1

FESTA
FAVÁGÓ KORONG



R.s. leírás
21804 Ø 125 mm Ø 22,2 mm 14T 1

FESTA
PROFILMARÓ M14

R.s. leírás
21808 Ø 30 mm / 105 mm 10

NEW

KÖRFŰRÉSZ TÁRCSA



R.s.	Leírás			
21809	Ø 125 mm x 4T	Ø 22,2 mm		1

NEW

FESTA LAMELLÁS CSISZOLÓ KÉTOLDALAS



R.s.	leírás	hrubost	
21760	Ø 125 mm Ø 22,2 mm	P40	10
21761	Ø 125 mm Ø 22,2 mm	P60	10
21762	Ø 125 mm Ø 22,2 mm	P80	10
21763	Ø 125 mm Ø 22,2 mm	P100	10
21764	Ø 125 mm Ø 22,2 mm	P120	10

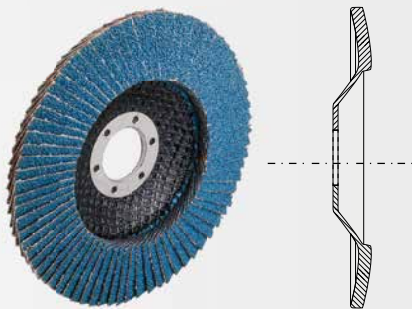

FESTA LAMELLÁS CSISZOLÓ

grinding disc suitable for grinding stainless steel



R.s.	leírás	érdesség	
22140	Ø 115 mm Ø 22,2 mm	P40	5
22141	Ø 115 mm Ø 22,2 mm	P60	5
22142	Ø 115 mm Ø 22,2 mm	P80	5
22143	Ø 115 mm Ø 22,2 mm	P100	5
22145	Ø 125 mm Ø 22,2 mm	P40	5
22146	Ø 125 mm Ø 22,2 mm	P60	5
22147	Ø 125 mm Ø 22,2 mm	P80	5
22148	Ø 125 mm Ø 22,2 mm	P100	5
22150	Ø 150 mm Ø 22,2 mm	P40	5
22151	Ø 150 mm Ø 22,2 mm	P60	5
22155	Ø 150 mm Ø 22,2 mm	P80	5
22156	Ø 150 mm Ø 22,2 mm	P100	5

NEW

FESTA LAMELLÁS CSISZOLÓ GYÉMÁNT



- Kerámia csempék
- Márvány
- Gránit



- nincs szükség vízutásra

R.s.	leírás			
24647	Ø 115 mm Ø 22,2 mm	P60		1
24648	Ø 115 mm Ø 22,2 mm	P120		1
24649	Ø 115 mm Ø 22,2 mm	P200		1

LAMELLÁS CSISZOLÓ



R.s.	leírás	érdesség	
21780	Ø 115 mm Ø 22,2 mm	P40	10
21781	Ø 115 mm Ø 22,2 mm	P60	10
21782	Ø 115 mm Ø 22,2 mm	P80	10
21783	Ø 115 mm Ø 22,2 mm	P100	10
21784	Ø 115 mm Ø 22,2 mm	P120	10
21786	Ø 125 mm Ø 22,2 mm	P40	10
21787	Ø 125 mm Ø 22,2 mm	P60	10
21788	Ø 125 mm Ø 22,2 mm	P80	10
21789	Ø 125 mm Ø 22,2 mm	P100	10
21790	Ø 125 mm Ø 22,2 mm	P120	10
21792	Ø 150 mm Ø 22,2 mm	P40	10
21793	Ø 150 mm Ø 22,2 mm	P60	10
21794	Ø 150 mm Ø 22,2 mm	P80	10
21795	Ø 150 mm Ø 22,2 mm	P100	10
21796	Ø 150 mm Ø 22,2 mm	P120	10

KÖRKEFE NYLON



R.s.	leírás	
21798	Ø 125 mm Ø 22,2 mm	1



FESTA



20mm

FESTA

KÖRKEFE DÖNTÖTT

· sárgaréz bevonattal

M14

R.s.	leírás	huzal	
21900	Ø 100 mm M14	s 0,3	60
21902	Ø 125 mm M14	s 0,3	42



10mm

FESTA

KÖRKEFE DÖNTÖTT

· sárgaréz bevonattal

M14

R.s.	leírás	huzal	
22001	Ø 100 mm M14	s 0,3	60
21901	Ø 125 mm M14	s 0,3	42

FESTA

KÖRKEFE DÖNTÖTT

· sárgaréz,

M14

R.s.	leírás	huzal	
21920	Ø 100 mm M14	s 0,3	60

FESTA

FAZÉKKEFE

· sárgaréz bevonattal

M14

R.s.	leírás	huzal	
21903	Ø 65 mm M14	s 0,3	60
22002	Ø 75 mm M14	s 0,3	80
21904	Ø 85 mm M14	s 0,3	60
22003	Ø 100 mm M14	s 0,3	36
21905	Ø 125 mm M14	s 0,3	24
21906	Ø 150 mm M14	s 0,3	12

FESTA

FAZÉKKEFE

· sárgaréz,

M14

R.s.	leírás	huzal	
21925	Ø 75 mm M14	0,3 mm	80
21926	Ø 100 mm M14	0,3 mm	36

FESTA

KÖRKEFE + HÉZAGOLÓ GYÜRÜK

· sárgaréz bevonattal

· redukciós tárcsák

R.s.	leírás	huzal	
22007	Ø 100 mm Ø 20 mm	s 0,3	60
22008	Ø 125 mm Ø 20 mm	s 0,3	42
22009	Ø 150 mm Ø 32,2 mm	s 0,3	32
22010	Ø 175 mm Ø 32,2 mm	s 0,3	20
22011	Ø 200 mm Ø 32,2 mm	s 0,3	20

FESTA

FAZÉKKEFE SODROTT

· edzett

INOX M14

R.s.	leírás	huzal	
22037	Ø 65 mm M14	s 0,5	60
22038	Ø 80 mm M14	s 0,5	24

FESTA

FAZÉKKEFE SODROTT

· edzett

M14

R.s.	leírás	huzal	
22004	Ø 65 mm M14	s 0,3	60
22005	Ø 75 mm M14	s 0,3	24
22006	Ø 100 mm M14	s 0,3	24
21907	Ø 125 mm M14	s 0,3	24
21908	Ø 150 mm M14	s 0,3	12

FESTA

KÖRKEFE SODROTT SAROKCSISZOLÓRA

· edzett

M14

R.s.	leírás	huzal	počet copů	
21911	Ø 100 mm M14	s 0,5	30	60
21912	Ø 115 mm M14	s 0,5	32	42
21913	Ø 125 mm M14	s 0,5	36	42
21914	Ø 150 mm M14	s 0,5	40	32

FESTA
KÖRKEFE SODROTT SAROKCSISZOLÓRA

· edzett

M14

R.sz.	leírás	huzal	
22012	Ø 100 mm M14	s 0,5	60
22013	Ø 115 mm M14	s 0,5	42
22014	Ø 125 mm M14	s 0,5	42
22015	Ø 150 mm M14	s 0,5	32
22016	Ø 178 mm M14	s 0,5	20

FESTA
KÖRKEFE SODROTT SAROKCSISZOLÓRA

· edzett

INOX M14

R.sz.	leírás	huzal	
22039	Ø 100 mm M14	s 0,5	60
22040	Ø 125 mm M14	s 0,5	42

FESTA
KÖRKEFE SODROTT DÖNTÖTT

· edzett

M14

R.sz.	leírás	huzal	
22017	Ø 100 mm M14	s 0,5	60
21909	Ø 115 mm M14	s 0,5	42
21910	Ø 125 mm M14	s 0,5	42

FESTA
KÖRKEFE CSAPOS, SODROTT

· edzett



R.sz.	leírás	huzal	
22023	Ø 75 mm	s 0,5	10

FESTA
FAZÉKKEFE CSAPOS, SODROTT

· edzett



R.sz.	leírás	huzal	
22024	Ø 75 mm	s 0,5	12

FESTA
KÖRKEFE CSAPOS DÖNTÖTT

· edzett



R.sz.	leírás	huzal	
22025	Ø 75 mm	s 0,5	12

NEW

FESTA
KÖRKEFE SODROTT SAROKCSISZOLÓRA

R.sz.	leírás	huzal	
21950	Ø 200 mm 25,4 mm		1

FESTA
FAZÉKKEFE CSAPOS

· sárgaréz bevonattal



R.sz.	leírás	huzal	
22030	Ø 65 mm	s 0,3	12
22031	Ø 75 mm	s 0,3	12

FESTA
KÖRKEFE CSAPOS

· sárgaréz bevonattal



R.sz.	leírás	huzal	
22026	Ø 50 mm	s 0,3	15
22027	Ø 63 mm	s 0,3	15
22028	Ø 75 mm	s 0,3	10
22029	Ø 100 mm	s 0,3	15

FESTA
ECSETKEFE

R.sz.	leírás	huzal	
22058	Ø 12 mm	s 0,3	25
22059	Ø 25 mm	s 0,3	25

FESTA
ECSETKEFE

· sárgaréz bevonattal



R.sz.	leírás	huzal	
22018	Ø 12 mm	s 0,3	15
22019	Ø 17 mm	s 0,3	15
22020	Ø 25 mm	s 0,3	25

FESTA
ECSETKEFE SODROTT

· edzett



R.sz.	leírás	huzal	
22021	Ø 19 mm	s 0,5	30
22022	Ø 22 mm	s 0,5	25



FESTA
FAZÉKKEFE NYLON

R.sz.	leírás	huzal	
21940	Ø 75 mm M14	1,2 mm	1
21941	Ø 100 mm M14	1,2 mm	1



FESTA
KÖRKEFE NYLON

R.sz.	leírás	huzal	
21930	Ø 125 mm M14	1,2 mm	10
21931	Ø 150 mm M14	1,2 mm	15



FESTA
POLÍR KÖRKEFE CSAPOS

R.sz.	leírás	huzal	
22032	Ø 100 mm	1,2 mm	12

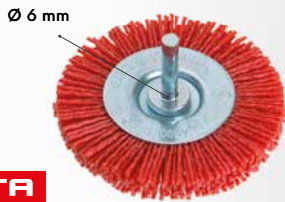

FESTA
KÖRKEFE NYLON CSAPOS

R.sz.	leírás	huzal	
21935	Ø 50 mm	1,2 mm	15
21936	Ø 75 mm	1,2 mm	10
21937	Ø 100 mm	1,2 mm	15



KÖRKEFE NYLON

R.sz.	leírás	
22088	Ø 65 mm	9
22090	Ø 100 mm	5



KÖRKEFE NYLON

R.sz.	leírás	
22083	Ø 115 mm Ø 22,2 mm	10
22084	Ø 125 mm Ø 22,2 mm	10
22085	Ø 150 mm Ø 22,2 mm	10



KÖRKEFE NYLON

R.sz.	leírás	
22095	Ø 178 mm	1



FESTA
GYÉMÁNT POLÍROZÓ TÁRCSA TÉPŐZÁRRAL

- Kerámia csempék
- üveg
- Márvány
- Gránit

R.sz.	leírás	hrubost	
24665	Ø 100 mm	● P60	10
24666	Ø 100 mm	● P120	10
24667	Ø 100 mm	● P200	10

FESTA
GYÉMÁNT POLÍROZÓ TÁRCSA Ø 100 MM, TÉPŐZÁRRAL

- Kerámia csempék
- üveg
- Márvány
- Gránit

R.sz.	érdesség	
22701	50	1
22702	100	1
22703	200	1
22704	400	1
22705	800	1
22706	1500	1
22707	3000	1



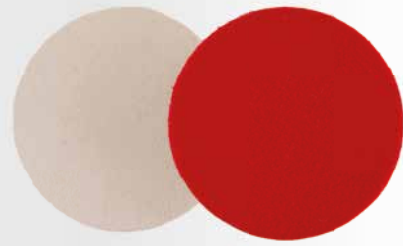

POLÍROZÓKORONG TÉPŐZÁRAS



R.sz.	leírás	leírás	csomagolás
22065	Ø 125 mm	tépőzár	20
22066	Ø 150 mm	tépőzár	20

POLÍROZÓKORONG TÉPŐZÁRAS



R.sz.	leírás	leírás	csomagolás
22070	Ø 115 mm		20
22071	Ø 125 mm	tépőzár	20
22072	Ø 150 mm		20

FESTA

GUMITÁNYÉR CSAPOS

- M14 | Ø 8 mm
- EVA 10 mm

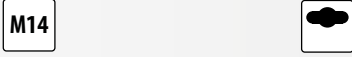

R.sz.	leírás	csomagolás
22062	Ø 115 mm	25
22063	Ø 125 mm	25
22064	Ø 150 mm	10



FESTA

CSISZOLÓTÁNYÉR MENETES FIBERTÁRCSÁHOZ

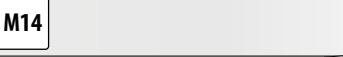

R.sz.	leírás	csomagolás
22073	Ø 125 mm, M14	1
22074	Ø 150 mm, M14	1



FESTA

GUMITÁNYÉR

- sarokcsiszolókhöz
- for 24665-24667, 22701-22707

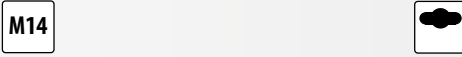

R.sz.	leírás	csomagolás
22043	Ø 100 mm tépőzár	1



GUMITÁNYÉR

- sarokcsiszolókhöz

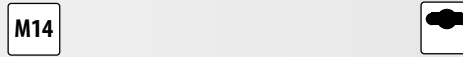

R.sz.	leírás	csomagolás
22044	Ø 125 mm M14 tépőzár	15
22060	Ø 150 mm M14 tépőzár	6



ADAPTER



R.sz.	leírás	csomagolás
22087		1



GUMITÁNYÉR CSAPOS

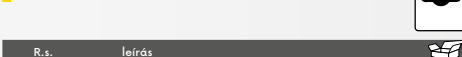

R.sz.	leírás	csomagolás
22061	Ø 125 mm tépőzár	6

GUMITÁNYÉR CSAPOS

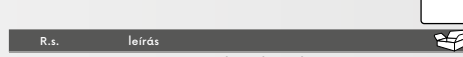

R.sz.	leírás	csomagolás
22041	Ø 125 mm bind with screw	11
22042	Ø 125 mm tépőzár	11

R.sz.	leírás	csomagolás
22091	Ø 50 mm P240	1
22092	Ø 75 mm P240	1
22093	Ø 100 mm P240	1

FESTA

FIBER TÁRCSA - Ø 125 MM



R.sz.	érdesség	csomagolás
22160	P40	1
22161	P60	1
22162	P80	1
22163	P100	1
22164	P120	1



FESTA

FIBER TÁRCSA - Ø 150 MM



R.sz.	érdesség	csomagolás
22167	P80	1



FESTA

CSISZOLÓTÁRCSA TÉPŐZÁRAS Ø 150 MM

3x

R.sz.	érdesség	
22045	P40	1
22046	P60	1
22047	P80	1
22048	P100	1
22049	P120	1
22050	P150	1
22051	P180	1
22052	P220	1

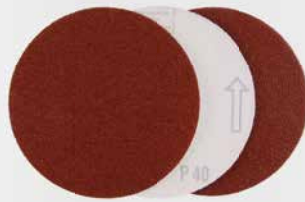
**FESTA**

CSISZOLÓTÁRCSA TÉPŐZÁRAS Ø 125 MM

3x

R.sz.	érdesség	
22053	P40	1
22054	P60	1
22055	P80	1
22056	P100	1
22057	P120	1

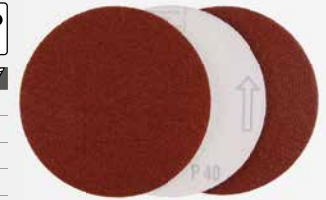
**FESTA**VIBRÁCIÓS CSISZOLÓ
94 X 94 X 94 MM

R.sz.	érdesség	
21831	P60	1
21832	P80	1
21834	P120	1

3x

R.sz.	érdesség	
22096	P40	20
22097	P60	20
22098	P80	20
22099	P120	20

FESTAVÉGTELEN CSISZOLÓSZALAG
- 75 X 533 MM

R.sz.	érdesség	
21810	P40	20
21811	P60	20
21812	P80	20
21813	P100	20
21814	P120	20



CSISZOLÓVÁSZON 93 X 230 MM

5x

R.sz.	érdesség	lyukak száma	
21740	P40	8	20
21741	P60	8	20
21742	P80	8	20
21743	P100	8	20
21744	P120	8	20



CSISZOLÓVÁSZON 115 X 280 MM

5x

R.sz.	érdesség	lyukak száma	
21750	P40	10	20
21751	P60	10	20
21752	P80	10	20
21753	P100	10	20
21754	P120	10	20



CSISZOLÓVÁSZON 230X280 MM

10x

R.sz.	érdesség	
21732	P40	1
21734	P60	1
21735	P80	1
21736	P100	1
21737	P120	1

10x

CSISZOLÓPAPÍR VÍZÁLLÓ
230X280 MM

R.sz.	érdesség	
21701	P60	1
21702	P80	1
21703	P100	1
21704	P120	1
21705	P150	1
21706	P180	1
21709	P240	1

10x

CSISZOLÓPAPÍR 230X280 MM

R.sz.	érdesség	
21715	P40	1
21716	P60	1
21717	P80	1
21718	P100	1
21719	P120	1
21720	P150	1
21721	P180	1
21724	P240	1

NEW



FESTA

CSISZOLÓ TUSKÓ

· Ø 150 mm



R.sz.	Leírás	1
22119		1

FESTA

CSISZOLÓ TUSKÓ

· gyors fogás



R.sz.	leírás	10
22067	170 x 70 mm	10

CSISZOLÓ TUSKÓ



R.sz.	leírás	100
22075	210 x 105 mm	100
22076	160 x 85 mm	100

CSISZOLÓ TUSKÓ



R.sz.	leírás	10
22077	125 x 68 mm	10

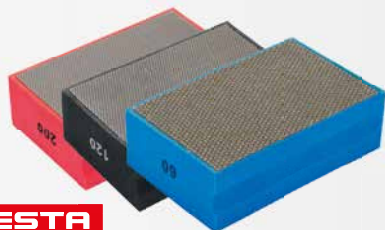

FESTA

GYÉMÁNTCSISZOLÓ SZIVACS

- 90 x 55 x 25 mm
- Kerámia csempék
- üveg
- Márvány
- Gránit



R.sz.	érdesség	10
22115	P60	10
22116	P120	10
22117	P200	10

CSISZOLÓLAPÁT TÁRCSA

R.sz.	érdesség	leírás	1
21850	P40		1
21851	P60		1
21852	P80	20 x 20, Ø 6 mm	1
21853	P100		1
21854	P120		1
21855	P40		1
21856	P60		1
21857	P80	30x30, Ø 6mm	1
21858	P100		1
21859	P120		1
21860	P40		1
21861	P60		1
21862	P80	60x30, Ø 6mm	1
21863	P100		1
21864	P120		1



FESTA

CSISZOLÓ SZIVACS 100 X 70 X 28 MM - LESARKÍTOTT



R.sz.	érdesség	10
22106	P 60	10
22107	P 80	10
22108	P 100	10
22109	P 120	10



FESTA

CSISZOLÓ SZIVACS 100 X 70 X 25 MM



R.sz.	érdesség	20
22100	P60	20
22101	P80	20
22102	P100	20
22103	P120	20
22104	P180	20
22105	P220	20



FESTA

CSISZOLÓ SZIVACS 120 X 95 X 10 MM



R.sz.	érdesség	20
22110	P80	20
22111	P120	20
22112	P180	20
22113	P220	20

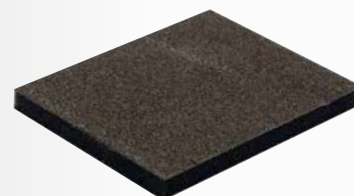

FESTA



R.sz.	leírás	r. fogú	
Ø 115 mm			
22300	Ø 115 x 22 mm	40	1
Ø 125 mm			
22301	Ø 125 x 22 mm	40	1
Ø 140 mm			
22302	Ø 140 x 20 mm	24	1
22303	Ø 140 x 20 mm	30	1
Ø 150 mm			
22305	Ø 150 x 20 mm	24	1
Ø 160 mm			
22307	Ø 160 x 20 mm	18	1
22309	Ø 160 x 20 mm	24	1
22310	Ø 160 x 20 mm	30	1
22311	Ø 160 x 20 mm	36	1
22312	Ø 160 x 20 mm	48	1
22313	Ø 160 x 20 mm	60	1
Ø 165 mm			
22314	Ø 165 x 20 mm	24	1
Ø 180 mm			
22315	Ø 180 x 30 mm	24	1
22317	Ø 180 x 30 mm	50	1
22318	Ø 180 x 20 mm	50	1
Ø 185 mm			
22316	Ø 185 x 20 mm	24	1
Ø 190 mm			
22319	Ø 190 x 20 mm	40	1
22320	Ø 190 x 30 mm	40	1
Ø 200 mm			
22322	Ø 200 x 30 mm	24	1
22324	Ø 200 x 30 mm	40	1
22326	Ø 200 x 30 mm	60	1
Ø 205 mm			
22328	Ø 205 x 30 mm	40	1
22329	Ø 205 x 30 mm	60	1
Ø 210 mm			
22332	Ø 210 x 30 mm	40	1
22333	Ø 210 x 30 mm	60	1
Ø 250 mm			
22335	Ø 250 x 30 mm	40	1
22337	Ø 250 x 30 mm	60	1
Ø 300 mm			
22340	Ø 300 x 30 mm	40	1
22343	Ø 300 x 30 mm	60	1
22345	Ø 300 x 30 mm	96	1
Ø 350 mm			
22350	Ø 350 x 30 mm	40	1
22351	Ø 350 x 30 mm	54	1
Ø 400 mm			
22355	Ø 400 x 30 mm	40	1
22357	Ø 400 x 30 mm	60	1
Ø 500 mm			
22365	Ø 500 x 30 mm	60	1
Ø 600 mm			
22370	Ø 600 x 30 mm	60	1



FESTA

KÖRFŰRÉSZ TÁRCSA, VIDIA LAPPAL TCT

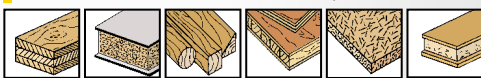

SZŰKÍTŐ GYŰRŰ

R.sz.	leírás	
22399	Ø 20 16 mm	1
22398	Ø 30 25 mm	1



FESTA

OSZCILLÁLÓ MULTI-TOOL TARTOZÉKKÉSZLET

for 28045

FESTA
POWER X TOOLS



4x

3x BI-METAL



1x SK5

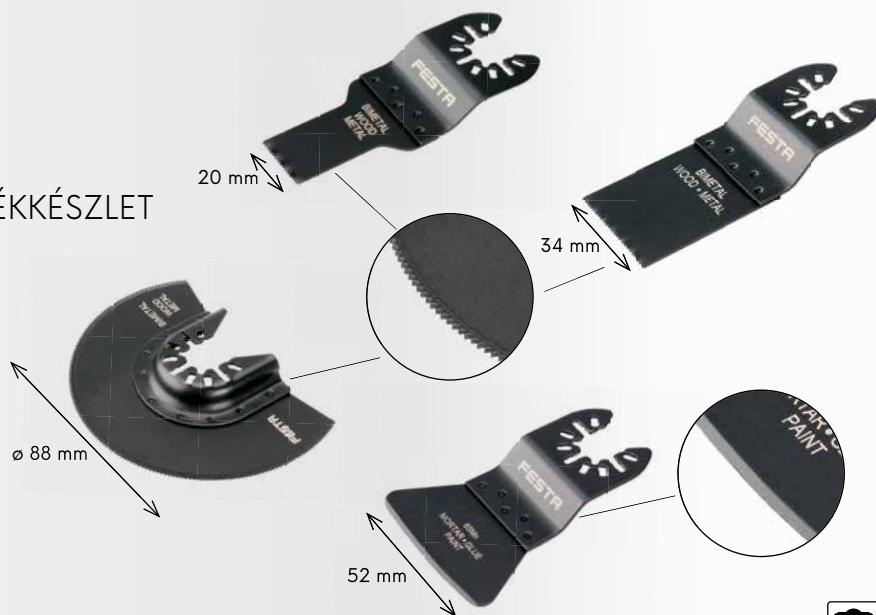

R.s. leírás

24322



10

FESTA

OSZCILLÁLÓ MULTI-TOOL TARTOZÉKKÉSZLET

for 28045

FESTA
POWER X TOOLS



4x

3x CARBIDE



1x

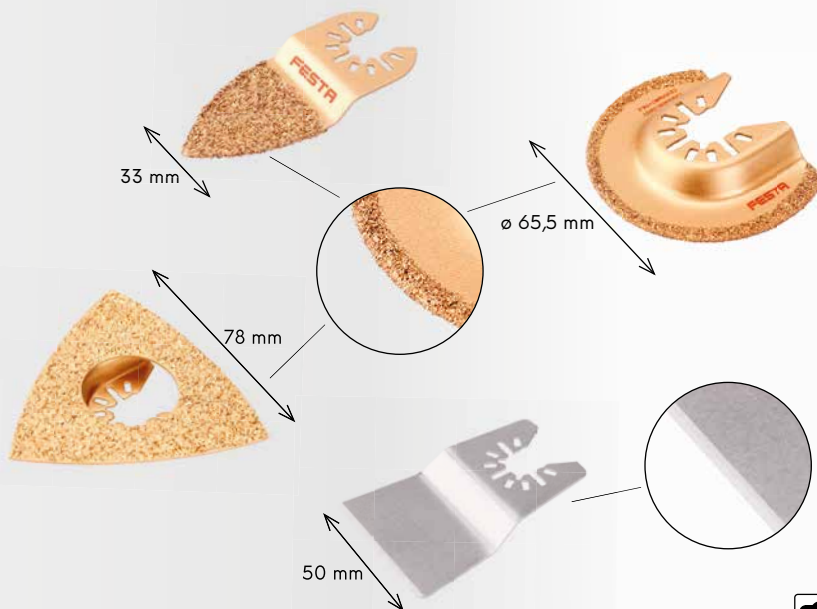

R.s. leírás

24321



10

OSZCILLÁLÓ MULTI-TOOL TARTOZÉKKÉSZLET

for 28045

FESTA
POWER X TOOLS



HCS 3x

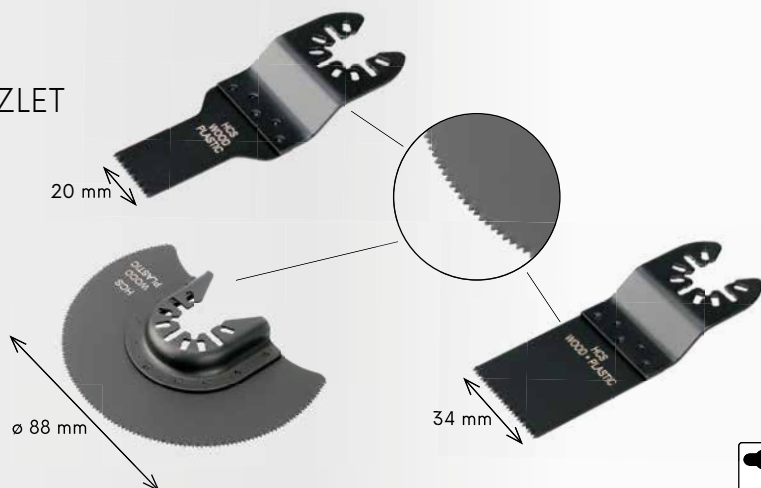

R.s. leírás

24320



10

PROFI DEKOPIRFŰRÉS LAPOK
NÉMETORSZÁGBAN GYÁRTOTT LÉZERKIÉGETÉSES TECHNOLOGIÁVAL



DEKOPIRFŰRÉS LAPOK, HSS (AEG, BOSCH, FESTO, MAKITA, METABO)

	24060	50mm/1mm	0,7 mm/ 36TPI	31007	5 db	10	
	24061	50mm/1mm	1,2 mm/ 21TPI	31012	5 db	10	
	24062	50mm/1mm	2,0 mm/ 13TPI	31020	5 db	10	
	24063	75mm/1mm	3,0 mm/ 8TPI	31030	5 db	10	
	24064	100mm/1mm	1,2 mm/ 21TPI	31112	5 db	10	
	24065	100mm/1,3mm	2,0 mm/ 13TPI	31112	5 db	10	
	24066	75mm/1,45mm	2,0 mm/ 13TPI	31220	5 db	10	
	24067	120mm/1,3mm	1,8 - 2,4 mm/ 10 - 14 TPI	31220	5 db	10	
	24068	75mm/1,45mm	2,5 mm/ 10 TPI	32225	5 db	10	
	24069	75mm/1,45mm	4 mm/ 6 TPI	32240	5 db	10	
	24070	75mm/1,3mm	4 mm/ 6 TPI	32340	5 db	10	
	24071	75mm/1,3mm	4 mm/ 6 TPI	32440	5 db	10	
	24072	75mm/1,45mm	2,5 mm/ 10 TPI	32625	5 db	10	
	24073	85mm/1,45mm	3 mm/ 8 TPI	32730	5 db	10	
	24074	85mm/1,45mm	4 mm/ 6 TPI	32730	5 db	10	
	24075	75mm/1,45mm	2,5 1,2 mm/10 21 TPI	32825	5 db	10	
	24076	75mm/1,7mm	4 mm 6 TPI	32940	5 db	10	
	24077	120mm/1,3mm	4 mm 6 TPI	32040	5 db	10	
	24078	105mm/1,45mm	4 mm 6 TPI	34040	5 db	10	
	24055	55mm	karbid		5 db	1	

DEKOPIRFŰRÉSZ LAPOK, HSS (BLACK & DECKER, SKIL)

	24080	50mm 1,0 mm	1,2 21 TPI	11012	5 db	10	
	24081	75mm 1,0 mm	3,0 8 TPI	11030	5 db	10	
	24082	75mm 1,45 mm	2,5 10 TPI	12225	5 db	10	
	24083	75mm 1,45 mm	4 6 TPI	12240	5 db	10	
	24084	75mm 1,3 mm	4 6 TPI	12340	5 db	10	
	24085	50mm 1,0 mm	2,0 13 TPI	12420	5 db	10	
	24086	75mm 1,3 mm	4,0 6 TP	12440	5 db	10	
	24087	75mm 1,45 mm	2,5 10 TPI	12625	5 db	10	

	Lágy acél (alacsony szénttartalommal)		Acéllemez		Rozsdamentes acél		Fóliakaszott deszka
	Nem vastartalmú fémek		Kemény- és puhafa		Forgácsdeszka		Műanyagok – plasztok
	Funérlemez		Leces furnélemez		Szögcséc		
	Szendvicsanyag		csempére, kerámiához		Alumínium		

DEKOPIRFŰRÉSZ LAP ÁLLVÁNY

- állva pengével 24098 – 24060 · 5 db
- 24080 · 5 db
- 24061 · 5 db
- 24062 · 5 db
- 24081 · 5 db
- 24063 · 5 db
- 24066 · 5 db
- 24067 · 5 db
- 24082 · 5 db
- 24068 · 5 db
- 24083 · 5 db
- 24069 · 5 db
- 24084 · 5 db
- 24070 · 5 db
- 24086 · 5 db
- 24071 · 5 db
- 24087 · 5 db
- 24072 · 5 db
- 24073 · 5 db
- 24074 · 5 db
- 24075 · 5 db
- 24076 · 5 db



SZŰRŐFŰRÉSZ LAP KLT.



5x



R.sz.	leírás	50
24045	készlet	50

R.sz.	leírás	1
24099	64 x 50 cm – állvány	1
24098	64 x 50 cm – állva pengével	1

FESTA

ORRFŰRÉSZ LAPOK

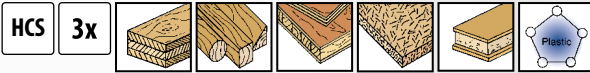

R.sz. leírás
24301 150 x 19 x 1,3 mm TPI 6



1

FESTA

ORRFŰRÉSZ LAPOK

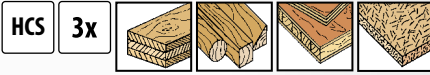

R.sz. leírás
24302 225 x 19 x 1,3 mm TPI 3



1

FESTA

ORRFŰRÉSZ LAPOK

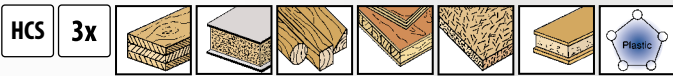

R.sz. leírás
24303 200 x 19 x 1,3 mm TPI 6 - 10



1

FESTA

ORRFŰRÉSZ LAPOK

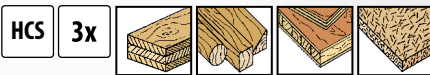

R.sz. leírás
24304 240 x 19 x 1,5 mm TPI 5



1

FESTA

ORRFŰRÉSZ LAPOK

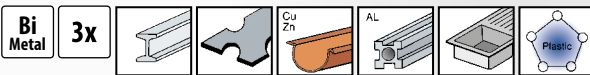

R.sz. leírás
24305 150 x 19 x 1 mm TPI 24

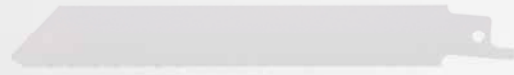

1

FESTA

ORRFŰRÉSZ LAPOK

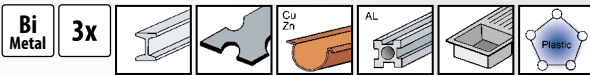

R.sz. leírás
24306 150 x 19 x 1 mm TPI 9



1

FESTA

ORRFŰRÉSZ LAPOK



R.sz. leírás
24308 225 x 19 x 1 mm TPI 10 - 14

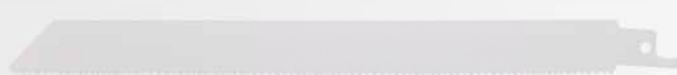

1

FESTA

ORRFŰRÉSZ LAPOK



R.sz. leírás
24310 150 x 22 x 1,6 mm TPI 9



1

FESTA

ORRFŰRÉSZ LAPOK



R.sz.	leírás	
24313	225 x 22 x 1,6 mm TPI 6	1

FESTA

ORRFŰRÉSZ LAPOK

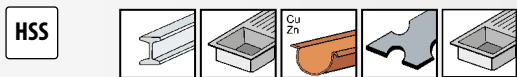

R.sz.	leírás	
24050	203 x 19 x 1 mm TPI 10 - 14	25

FESTA

ORRFŰRÉSZ LAPOK

· Keményfém technológia

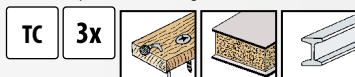

R.sz.	leírás	
24312	225 x 19 x 1,3 mm TPI 6 - 9	1

FESTA

ORRFŰRÉSZ LAPOK

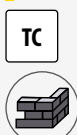

R.sz.	leírás	
24315	305 x 50 x 1,5 mm	1
24316	455 x 50 x 1,5 mm	25

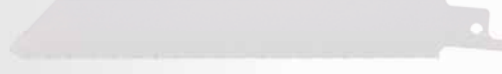
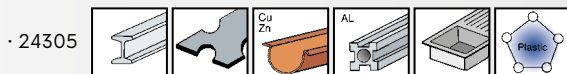
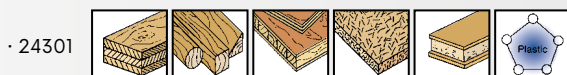

FESTA

ORRFŰRÉSZ LAP KLT.



R.sz.	leírás	
24314		1

FESTA

FOGANTYÚ A FŰRÉSZLAPOKHOZ

· fogantyú + 2x fűrészlap
· dugattyús fűrészlapokhoz



R.sz.	leírás	
24325		1





FESTA
INDUSTRY



FÜRÉSZLAP ÁGVÁGÓBA

· edzett fogazás



R.sz.	leírás	
24185	533 mm	1
24186	610 mm	1
24187	760 mm	1
24188	800 mm	1
24189	914 mm	1

FESTA

FÜRÉSZLAP ÁGVÁGÓBA

· edzett fogazás



R.sz.	leírás	
24169	350 mm	10
24167	450 mm	10
24166	533 mm	10
24163	610 mm	10
24164	760 mm	10
24168	800 mm	10
24165	914 mm	10



FÜRÉSZLAP



R.sz.	leírás	
24195	span 3 mm 300 mm	1
24196	span 4 mm 300 mm ferde fogazás	1
24197	span 5 mm 300 mm edzett fogazás	1
24192	penge a hentesfürészhez 450 mm	1



CSERE FÜRÉSZLAP FOGAZÁS

R.sz.	leírás	
24160	span 3 mm 300 mm	20
24161	span 4 mm 300 mm	20
24162	span 5 mm 300 mm	50

FÜRÉSZLAP

10x



R.sz.	leírás	
24108	6 mm 150 mm	1

VÁGÓSZÁL GYÉMÁNTOS KERÁMIÁRA



R.sz.	leírás	
24120	300 mm	50



FESTA

BI-METAL FÜRÉSZLAP

8 % COBALT



R.sz.	leírás	
24180	300 mm	125

FESTA

FÜRÉSZLAP



R.sz.	leírás	
24109	12,5 mm 300 mm Fémre	144
24118	25 mm 300 mm Fémrel, kétoldalú	72
24119	25 mm 300 mm fém és fa számára	72





96

MÉRŐSZALAGOK



101

FAMÉRCE



104

DERÉKSZÖG



106

VÍZMÉRTÉK



112

LASER



116

ÁCSCERUZA



120

JELŐLŐ SPRAY



122

TÖRHEŐ PENGÉS KÉS



137

PVC CSŐ VÁGÓ



140

CSAVARHÚZÓ



146

BITEK



154

DUGÓKULCS KLT.



159

DUGÓKULCS FEJ



164

VILLÁSKULCS



169

FOGÓ



179

LEMEZVÁGÓ OLLÓ



182

POPSZEGECS FOGÓ



188

RÁSPOLY ÉS FÁJLOK



190

FÉMFŰRÉS



195

KALAPÁCS



203

SZORÍTÓ

SZERSZÁMOK

94 - 205



KOMELON®

· PONTOS MINŐSÍTETT MÉRÉSEK

- II. pontossági osztály a ČSN 251104, EEC 755345
- SZABVÁNYOK NAK MEGFELEL Tiszerte nagyobb kopásállóságú - új nylon DURA NY bevonatú felület.

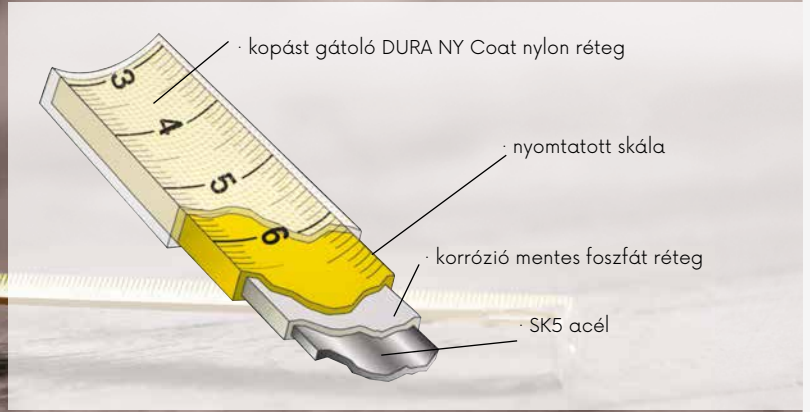

· kopást gátló DURA NY Coat nylon réteg

· nyomtatott skála

· korrózió mentes foszfát réteg

· SK5 acél



· Nylon kopásálló bevonatok DURA NY CoatTM



· Nylon kopásálló bevonatok DURA NY CoatTM



· Nylon kopásálló bevonatok DURA NY CoatTM

KOMELON® MÉRŐSZALAGOK



So.	leírás	
10002	2 m · 16 mm	10
10003	3 m · 16 mm	10
10005	5 m · 19 mm	10
10008	8 m · 25 mm	10

KOMELON® MÉRŐSZALAGOK



So.	leírás	
10025	5 m · 25 mm	10

KOMELON® MÉRŐSZALAGOK

- automatikus fék
- csúszásgátló gumizálás



So.	leírás	
10033	3 m · 16 mm	6
10035	5 m · 19 mm	6



KOMELON® MÉRŐSZALAGOK



So.	leírás	
10043	3 m · 16 mm	30
10045	5 m · 19 mm	30
10048	8 m · 25 mm	12



KOMELON® ACÉL MÉRŐSZALAG



So.	leírás	
10110	10 m · 10 mm	6
10120	20 m · 10 mm	6
10130	30 m · 10 mm	6



KOMELON® ÜVEGSZÁLAS MÉRŐSZALAG



So.	leírás	
10330	10 m · 13 mm	6
10332	20 m · 13 mm	6
10334	30 m · 13 mm	6
10336	50 m · 13 mm	6



KOMELON®

ÜVEGSZÁLAS MÉRŐSZALAG



So.	leírás	
10430	30 m · 13 mm	1
10450	50 m · 13 mm	1
10490	100 m · 13 mm	1



· illusztráció fotózás

KOMELON
ÁLLVÁNY

So.	leírás	
10998		1

KOMELON®
KOMELON
ÁLLVÁNY

· Elemek standon 10996

10003	5 db
10005	4 db
10008	1 db
10033	2 db
10035	3 db
10045	2 db
10025	3 db
10110	1 db
10120	1 db
10130	1 db
10430	1 db
10330	1 db
10332	1 db
10334	1 db
10336	1 db



· illusztráció fotózás

So.	leírás	
10999	állvány	1
10996	állvány	1



· információ a mérőszalagról



· mérőszalag hossza



· pontossági osztály



· megfelelőségi nyilatkozat - CE



· gyártási év



· A tanúsítványt kiállító akkreditált tanúsító szervezet száma



· Gyártó



· a szalag speciális beállítása



· Hőmérséklet, amelyen a vizsgálatot végezték

FESTA



FESTA

MÉRŐSZALAGOK

- skálázás nagy számjegyekkel
- csúszásgátló gumizálás
- Nylon bevonatok



So.	leírás	
11353	3 m · 19 mm	12
11355	5 m · 19 mm	12
11356	5 m · 25 mm	12
11358	8 m · 25 mm	6
11360	10 m · 25 mm	6



FESTA

MÉRŐSZALAGOK

- Nylon bevonatok
- ABS kark
- króm bevonatú fémkapocs
- automatikus fék
- csúszásgátló gumizálás PTE
- műanyag akasztó



So.	leírás	
11343	3 m · 16 mm	6
11345	5 m · 19 mm	6
11347	7,5 m · 25 mm	6



FESTA

MÉRŐSZALAGOK

- 3x fék
- mágneses kampó
- bezár
- csúszásgátló gumizálás



So.	leírás	
11323	3 m · 19 mm	10
11325	5 m · 25 mm	10
11327	7,5 m · 25 mm	6



FESTA

MÉRŐSZALAGOK

- mágneses kampó
- csúszásgátló gumizálás
- fluoreszkáló számjegyekkel
- skálázás nagy számjegyekkel



So.	leírás	
11102	2 m · 16 mm	10
11103	3 m · 16 mm	10
11105	5 m · 19 mm	12
11106	5 m · 25 mm	12
11107	7,5 m · 25 mm	10
11110	10 m · 25 mm	6



FESTA

MÉRŐSZALAGOK

- skálázás nagy számjegyekkel



So.	leírás	
11226	2 m · 16 mm	10
11239	3 m · 19 mm	10
11259	5 m · 19 mm	12
11260	7,5 m · 25 mm	6



FESTA

MÉRŐSZALAGOK

- automatikus fék
- csúszásgátló gumizálás



So.	leírás	
11333	3 m · 16 mm	12
11335	5 m · 19 mm	12
11337	7,5 m · 25 mm	6
11338	10 m · 25 mm	6



FESTA

MÉRŐSZALAGOK

- kis méretű mérőszalag
- Nylon bevonatok



So.	leírás	
11220	3 m · 16 mm	12
11221	5 m · 19 mm	12

**Johnney®****MÉRŐSZALAGOK**

· szalag matt kivitelezése

II. class

So.	leírás	
11002	2 m · 13 mm	12
11003	3 m · 13 mm	12
11005	5 m · 13 mm	12
11006	5 m · 19 mm	12
11007	7,5 m · 19 mm	12
11008	10 m · 25 mm	12

**MÉRŐSZALAGOK**· bezár
· csúszásgátló gumizálás

So.	leírás	
11082	2 m · 16 mm	12
11083	3 m · 16 mm	12
11085	5 m · 19 mm	12

**MÉRŐSZALAGOK**· metrikus és angol collos skálázás
· csúszásgátló gumizálás

So.	leírás	
11416	5 m · 19 mm	10

**MÉRŐSZALAGOK**

· bezár



So.	leírás	
11200	2 m · 13 mm	24
11201	2 m · 16 mm	24
11202	2 m · 19 mm	24
11204	3 m · 13 mm	24
11205	3 m · 16 mm	24
11206	3 m · 19 mm	24
11207	5 m · 19 mm	12
11208	5 m · 25 mm	12
11209	7,5 m · 25 mm	12
11210	10 m · 25 mm	12

**MÉRŐSZALAG NÉVEL ELLÁTVA,
3M · 16 MM****CE II. class**

Č.p.	jméno na metru	Č.p.	jméno na metru	Č.p.	jméno na metru	Č.p.	jméno na metru
13500	JIŘÍ	13509	MIROSLAV	13518	VÁCLAV	13527	MISTR
13501	PETR	13510	BIG BOSS	13519	JAKUB	13528	ONDŘEJ
13502	JOSEF	13511	ZDENĚK	13520	LUKÁŠ	13529	MAREK
13503	TOMÁŠ	13512	MICHAL	13521	2X MĚŘ	13530	STANISLAV
13504	JAN	13513	MILAN	13522	LADISLAV	13531	BOREC
13505	MARTIN	13514	KAREL	13523	DAVID	13532	TATÍNEK
13506	JAROSLAV	13515	VLADIMÍR	13524	ROMAN	13533	ANTONÍN
13507	FRANTIŠEK	13516	DĚDEČEK	13525	ŠIKULA	13534	ALEŠ
13508	PAVEL	13517	MÚJ METR	13526	RADEK		



10

**FESTA****MÉRŐSZALAG**

· hurok

CE II. class

So.	leírás	
12010	10 m · 10 mm	1
12020	20 m · 10 mm	1
12030	30 m · 10 mm	1
12050	50 m · 10 mm	6

**FESTA****ÜVEGSZÁLAS
MÉRŐSZALAG**

· hurok

CE II. class

So.	leírás	
12110	10 m · 13 mm	6
12120	20 m · 13 mm	1
12130	30 m · 13 mm	1
12150	50 m · 13 mm	1

**FESTA****MÉRŐSZALAG**

· hurok + horog

CE II. class

So.	leírás	
12220	20 m · 10 mm	6
12230	30 m · 10 mm	6
12250	50 m · 10 mm	6



FESTA

ACÉL MÉRŐSZALAG NYÍTOTT

· hurok



So.	leírás	
12433	30 m · 12,5 mm	20
12435	50 m · 12,5 mm	10



MÉRŐKERÉK

· tartós, könnyű és kompakt
 · a számláló előrehaladásnál hozzáad és visszalépésnél levon
 · beépített világítás az éjszakai munkához, 2 db aaa elem a táskában



So.	leírás	
15989	max. 10 km	2



FESTA

TELESZKÓPOS HOSSZMÉRŐ

· táskában

So.	leírás	
15983	0,7 - 3 m	10
15985	1,1 - 5 m	10
15988	1,6 - 8 m	5



ÖNTAPADÓ MÉRŐSZALAG



So.	leírás	
11311	1 m · 12,5 mm	30
11312	2 m · 12,5 mm	30
11313	3 m · 16 mm	30
11314	5 m · 19 mm	30



MÉRŐSZALAG

So.	leírás	
11444	1 m · 6 mm fehér	20



MÉRŐSZALAG

So.	leírás	
11420	1 m · 6 mm narancs	24



MÉRŐSZALAG

So.	leírás	
11425	1 m · 6 mm	25



FESTA

MÉRŐSZALAG

· skálázás nagy számjegyekkel
 · a klasszikus mérőszalag tulajdonságai



So.	leírás	
11410	2 m · 16 mm 6 szín	12



KULCSTARTÓ LIBELLA

So.	leírás	
11445		100

FAMÉRCE



So.	leírás	
13010	1 m · fehér	20
13020	2 m · fehér	10
13021	1 m · sárga	20
13022	2 m · sárga	10
13023	2 m · fehér - sárga	10

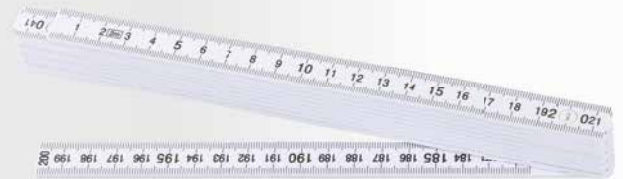
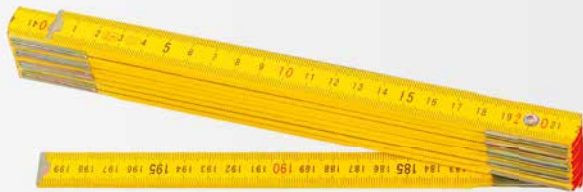
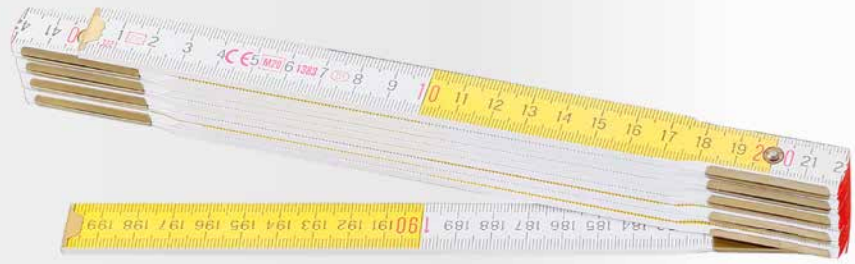

FAMÉRCE



So.	leírás	
13111	1 m · sárga	10
13120	2 m · sárga	5

FAMÉRCE



So.	leírás	
13211	1 m	1
13220	2 m	1



FAMÉRCE NÉVEL ELLÁTVA



So.	név	So.	név	So.	név	
13401	JÍŘÍ	13426	DANIEL			10
13402	JAN	13427	ANTONÍN			
13403	PETR	13428	VOJTĚCH	13451	JANA	
13404	JOSEF	13429	FILIP	13452	EVA	
13405	PAVEL	13430	ADAM	13453	PETRA	
13406	MARTIN	13431	MILOSLAV	13454	MAJKA	
13407	JAROSLAV	13432	MATĚJ	13455	HANA	
13408	TOMÁŠ	13433	ALEŠ	13456	ANNA	
13409	MIROSLAV	13434	JAROMÍR	13457	LENKA	
13410	ZDENĚK	13435	LIBOR	13458	KATKA	
13411	FRANTIŠEK	13436	DOMINIK	13459	LUCIE	
13412	VÁCLAV	13437	PATRIK	13460	ALENA	
13413	MICHAL	13438	VLASTIMIL	13461	VERONIKA	
13414	MILAN	13439	JINDŘICH	13462	MARTINA	
13415	KAREL	13440	MILOŠ	13463	JITKA	
13416	JAKUB	13441	JÁN	13464	BIG BOSS	
13417	LUKÁŠ	13442	PETER	13465	2 x MĚŘ	
13418	DAVID	13443	ONDŘEJ	13466	TATÍNEK	
13419	VLADIMÍR	13444	JOZEF	13467	DĚDEČEK	
13420	LADISLAV	13445	PAVOL	13468	ŠIKULA	
13421	ONDŘEJ	13446	L'UBOMÍR	13469	MISTR	
13422	ROMAN	13447	KAROL	13470	MACHR	
13423	STANISLAV	13448	RADOSLAV	13471	BOREC	
13424	MAREK	13449	VOJTĚCH	13472	UŽ JE MŮJ	
13425	RADEK	13450	ZDENKO	13473	MŮJ METR	

FAMÉRCE ÁLLVÁNY

· Elemek a Standben 13399

13401	· 15 db
13402	· 15 db
13403	· 15 db
13404	· 15 db
13405	· 15 db
13406	· 15 db
13412	· 15 db
13413	· 15 db
13414	· 15 db
13415	· 15 db
13416	· 15 db
13417	· 15 db
13418	· 15 db
13419	· 15 db
13420	· 15 db
13421	· 10 db
13422	· 10 db
13423	· 10 db
13424	· 10 db
13425	· 10 db
13426	· 10 db
13427	· 10 db
13428	· 10 db
13429	· 10 db
13430	· 10 db
13431	· 10 db
13432	· 10 db
13433	· 10 db
13434	· 10 db
13435	· 10 db
13436	· 10 db
13437	· 10 db
13438	· 10 db
13439	· 10 db
13440	· 10 db



So.	leírás	
13399	Famércével töltött állvány	1
13400	Állvány nélkül	1



FESTA

DIGITÁLIS TOLÓMÉRŐ



INOX	So.	leírás	
	14007	150 0,01 mm	10
	14008	200 0,01 mm	10
	14009	300 0,01 mm	10



DIGITÁLIS TOLÓMÉRŐ

· pontosság 0,2 mm, resolution 0,1 mm

So.	leírás	
14013	150 0,2 mm	10

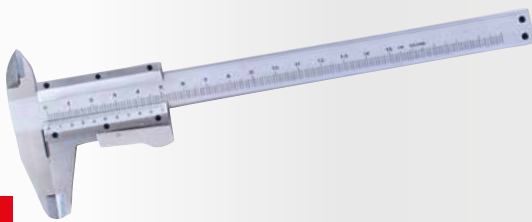

FESTA

TOLÓMÉRŐ



INOX	So.	leírás	
	14004	150 0,02 mm	10

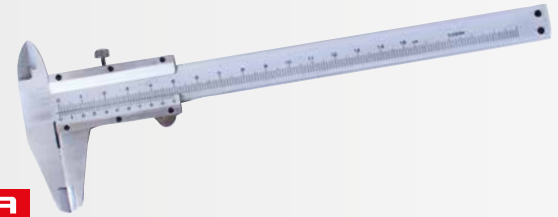

FESTA

TOLÓMÉRŐ



INOX	So.	leírás	
	14001	150 0,02 mm	10
	14002	200 0,02 mm	10
	14003	300 0,02 mm	10



FESTA

MIKROMÉTER



So.	leírás	
14040	0 - 0,25 0,01 mm	10
14045	25 - 50 0,01 mm	10



TOLÓMÉRŐ

HOBBY



So.	leírás	
14006	150 mm	50



FESTA

INDIKÁTOR ÓRA



INOX	So.	leírás	
	14035	0 - 10mm 0,01 mm	10



HÉZAG MÉRŐ

· 20 lap



So.	leírás	
14080	0,05 - 1 mm	10



KÖRZŐ



So.	leírás	
13285	200 mm	10



FESTA

RAJZTŰ, VÉSŐ TŰ



So.	leírás	
13281	150 mm	50



FESTA

RAJZTŰ, VÉSŐ TŰ



So.	leírás	
13282	200 mm	50

FESTA

VONALZÓ FOGANTYÚVAL

ALU



So.	leírás	
14030	600 mm	6

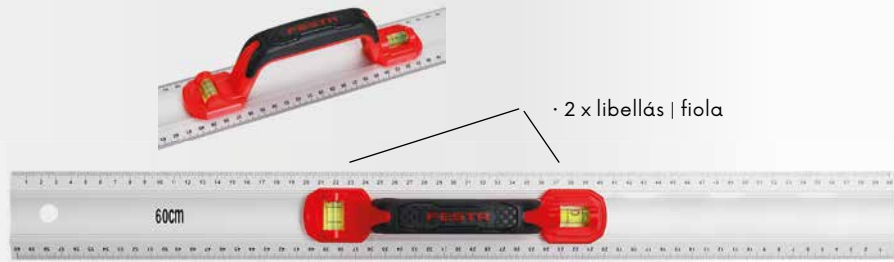

FESTA

ALU VONALZÓ

ALU



So.	leírás	
14015	400 mm	48
14017	600 mm	50
14019	1000 mm	40



FESTA

ACÉL VONALZÓ

INOX



So.	leírás	
14010	300 mm	10
14011	600 mm	10
14012	1000 mm	10

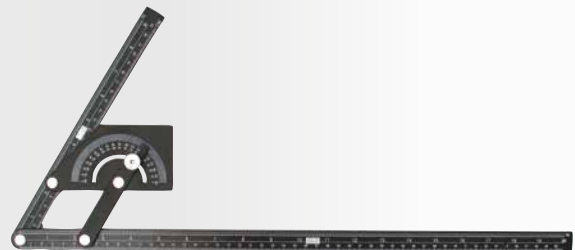
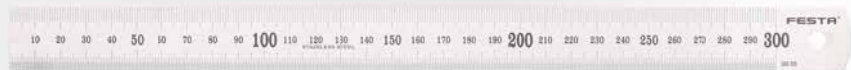

FESTA

SZÖGMÉRŐ FORGÓ KARRAL

· táska

So.	leírás	
14060	0° - 180° · 150 x 200 mm	10
14070	0° - 180° · 300 x 500 mm	5

SZÖGMÉRŐ

HOBBY

So.	leírás	
14075	0° - 180° · 230 x 500 mm	30



TÖBBCÉLÚ VONALZÓ

No.	Specification
14077	



10



TÖBBCÉLÚ VONALZÓ



So.	leírás	
14480	250 x 120 mm	1



KONTURMÁSOLÓ



So.	leírás	
14090	125 x 30 mm	1
14091	250 x 30 mm	1

FESTA

DERÉKSZÖG 3D



So.	leírás	
14418		10



FESTA

DERÉKSZÖG



So.	leírás	
14420	180 mm	10
14421	300 mm	10

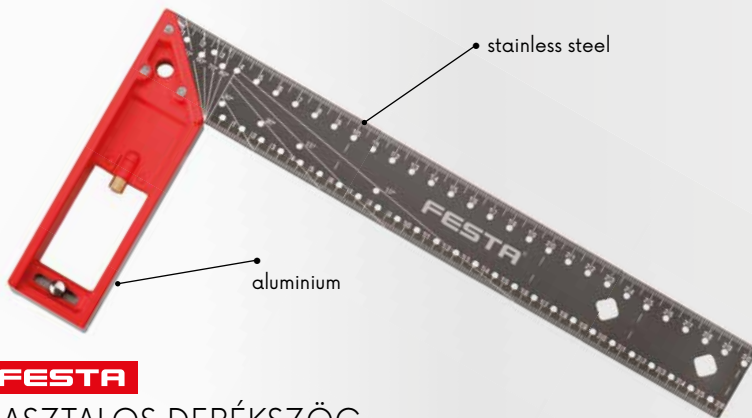

FESTA

ASZTALOS DERÉKSZÖG



No.	Specification	
14415	300 mm	6
14417	400 mm	6



FESTA

DERÉKSZÖG

ALU



So.	leírás	
14445	600 x 600 mm	1
14446	1200 x 1200 mm	1



FESTA

DERÉKSZÖG

ALU



FESTA

ASZTALOS DERÉKSZÖG



FESTA

ÁCS DERÉKSZÖG



So.	leírás	
14450	190 x 355 mm	6
14451	200 x 405 mm	6

So.	leírás	
14220	200 x 125 mm	10
14225	250 x 135 mm	10
14230	300 x 135 mm	10
14235	350 x 190 mm	10
14240	400 x 190 mm	10
14250	500 x 210 mm	10

So.	leírás	
14350	500 x 235 mm	10
14360	600 x 300 mm	10
14370	700 x 300 mm	10
14380	800 x 320 mm	10
14399	1000 x 360 mm	10

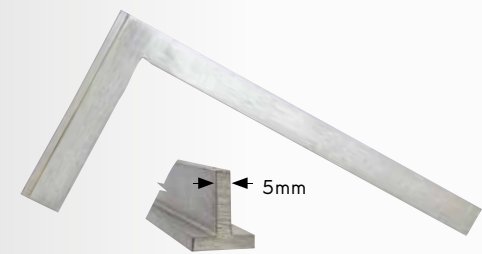
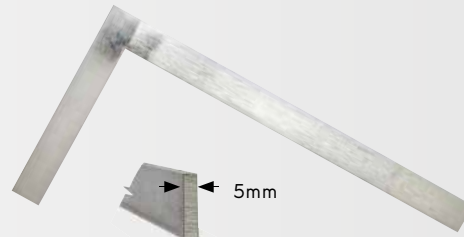
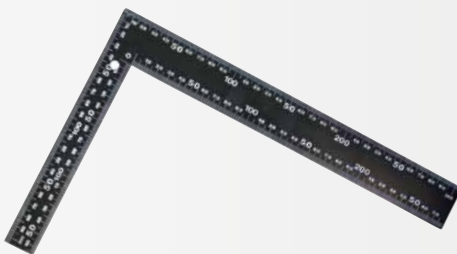

DERÉKSZÖG

LAKATOS DERÉKSZÖG
FELÜLETKEZELT

TALPAS DERÉKSZÖG
FELÜLETKEZELT

So.	leírás	
14410	300 x 200 mm	50
14411	600 x 400 mm	36

Zn	So.	leírás	
	14471	150 x 100 mm	25
	14472	250 x 125 mm	25
	14473	400 x 200 mm	30
	14474	600 x 300 mm	25

Zn	So.	leírás	
	14490	100 x 50 mm	10
	14491	150 x 75 mm	10
	14492	250 x 125 mm	10
	14493	400 x 200 mm	10
	14494	600 x 300 mm	10



DERÉKSZÖG

DERÉKSZÖG

ALU HOBBY

SZÖGMÁSOLÓ



So.	leírás	
14455	300 x 200 mm	50
14456	500 x 250 mm	50
14457	700 x 300 mm	40
14458	1000 x 450 mm	30

So.	leírás	
14425	250 x 130 mm	12
14430	300 x 130 mm	12
14435	350 x 156 mm	12
14440	400 x 156 mm	12

So.	leírás	
14025	255 x 285 mm	1

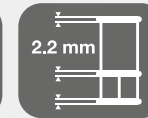
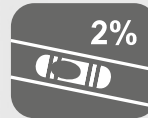

Minden termék elektromosan tesztelt, nyilvántartási számmal ellátott ISO 90001 tanúsítással rendelkező gyártó



HORIZONT[®]
MASTER



HORIZONT.

MASTER VÍZMÉRTÉK 2 LIBELLÁS

ALU

So.	leírás	
15033	60 cm	10



HORIZONT.

MASTER VÍZMÉRTÉK 3 LIBELLÁS

ALU

So.	leírás	
15034	80 cm	10
15035	100 cm	10



HORIZONT.

MASTER VÍZMÉRTÉK 3 LIBELLÁS, 2 FOGANTYÚS

ALU

So.	leírás	
15036	120 cm	10
15037	150 cm	10
15039	200 cm	10

HORIZONT®

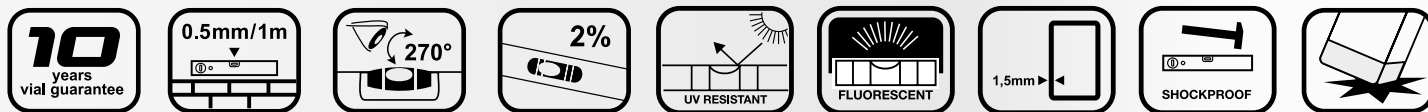

Minden termék elektromosan tesztelt, nyilvántartási számmal ellátott ISO 90001 tanúsítással rendelkező gyártó

HORIZONT®

VÍZMÉRTÉK 2 LIBELLÁS



So.	leírás	
15003	30 cm	30
15004	40 cm	30
15005	50 cm	30
15006	60 cm	30
15008	80 cm	30
15010	100 cm	30
15012	120 cm	10
15015	150 cm	10
15018	180 cm	10
15020	200 cm	10



HORIZONT®

VÍZMÉRTÉK 3 LIBELLÁS



So.	leírás	
15103	30 cm	30
15104	40 cm	30
15105	50 cm	30
15106	60 cm	30
15108	80 cm	30
15110	100 cm	30
15112	120 cm	10
15115	150 cm	10
15118	180 cm	10
15120	200 cm	10



HORIZONT®

VÍZMÉRTÉK 2 LIBELLÁS+MÁGNES



So.	leírás	
15204	40 cm	30
15205	50 cm	30
15206	60 cm	30
15208	80 cm	30
15210	100 cm	30
15212	120 cm	10
15215	150 cm	10
15218	180 cm	10
15220	200 cm	10



HORIZONT®

LEJTŐ VÍZMÉRTÉK 4 LIBELLÁS



So.	leírás	
15230	80 cm	10



HORIZONT SZÖGMÉRŐS VIZMÉRTÉK



So.	leírás	
15235	60 cm	1



HORIZONT ÖLESLÉC

ALU

So.	leírás	
15310	100 cm	10
15315	150 cm	10
15318	180 cm	10
15320	200 cm	10
15325	250 cm	10
15330	300 cm	10
15335	350 cm	10
15340	400 cm	10



HORIZONT ÖLESLÉC 1 LIBELLÁS

ALU

So.	leírás	
15415	150 cm	10
15418	180 cm	10
15420	200 cm	10
15425	250 cm	10
15430	300 cm	10



HORIZONT ÖLESLÉC 2 LIBELLÁS

ALU

So.	leírás	
15510	100 cm	10
15515	150 cm	10
15518	180 cm	10
15520	200 cm	10
15525	250 cm	10
15530	300 cm	10
15535	350 cm	10
15540	400 cm	5



HORIZONT ÖLESLÉC 2 FOGANTYÚS

ALU

So.	leírás	
15615	150 cm	10
15620	200 cm	10
15625	250 cm	10
15630	300 cm	10



HORIZONT. ÖLESLÉC 2 LIBELLÁS

ALU

So.	leírás	
15710	100 cm	10
15715	150 cm	10
15720	200 cm	10
15725	250 cm	10
15730	300 cm	10
15735	350 cm	10
15740	400 cm	5



HORIZONT. LEHÚZÓLÉC, TRAPÉZ ALAKÚ

TRAPÉZ ALAKÚ PROFIL

- A trapéz alakú profil finomabb felületkezeléshez használható
- Stukkókra és homlokzatra alkalmas
- Vékonyrétegű vakolatokhoz alkalmas

ALU

So.	leírás	
15810	100 cm	10
15812	120 cm	10
15815	150 cm	10
15818	180 cm	10
15820	200 cm	10
15825	250 cm	10
15830	300 cm	10



HORIZONT. LEHÚZÓLÉC, H ALAKÚ

"h" profil

- "H" profil finomabb felületkezelésre szolgál
- Stukkókra és homlokzatokra alkalmas
- Stukkó mennyezetre alkalmas

ALU

So.	leírás	
15850	100 cm	10
15853	150 cm	10
15855	180 cm	10
15860	200 cm	10
15870	250 cm	10
15880	300 cm	10

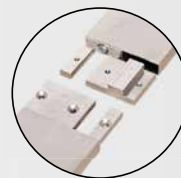

NEW

HORIZONT. ÖLESLÉC HORIZONT CSATLAKOZÓ RÉSZ

15301

leírás



HORIZONT. ÖLESLÉC 1 LIBELLÁS ÁLLÍTHATÓ

So.

leírás



15893	65 - 100 cm	1
15894	95 - 150 cm	1
15895	145 - 235 cm	1



HORIZONT. DERÉKSZÖG

ALU

So.

leírás



14485	800 x 1200 mm	1
14486	1000 x 1500 mm	1



HORIZONT.
HORIZONT
BEMUTATÓ ÁLLVÁNY

· elemek a standben 15998

- 15003 · 5 db
- 15004 · 5 db
- 15005 · 5 db
- 15006 · 5 db
- 15008 · 5 db
- 15010 · 5 db
- 15012 · 5 db
- 15015 · 3 db
- 15018 · 3 db
- 15020 · 3 db
- 15108 · 3 db
- 15206 · 3 db
- 15210 · 3 db

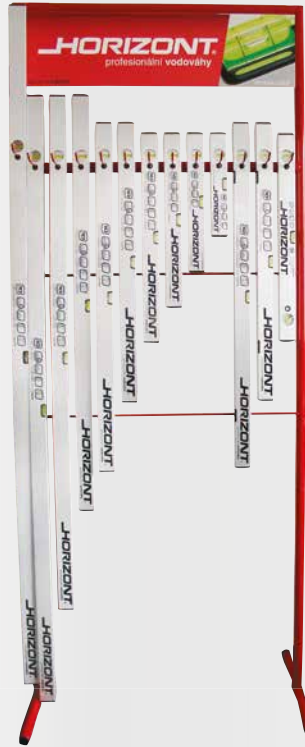

HORIZONT.
HORIZONT
BEMUTATÓ ÁLLVÁNY

· elemek a standben 15996

- 15004 · 5 db
- 15005 · 5 db
- 15006 · 5 db
- 15008 · 5 db
- 15010 · 5 db
- 15012 · 5 db
- 15015 · 5 db
- 15018 · 5 db
- 15020 · 5 db
- 15315 · 2 db
- 15320 · 2 db
- 15325 · 3 db
- 15515 · 2 db
- 15520 · 2 db
- 15525 · 3 db



So.	leírás	
15999	85 x 210 x 50 cm	1
15998	85 x 210 x 50 cm feltöltött állvány	1

So.	leírás	
15997	55 x 75 x 40 cm	1
15996	55 x 75 x 40 cm feltöltött állvány	1

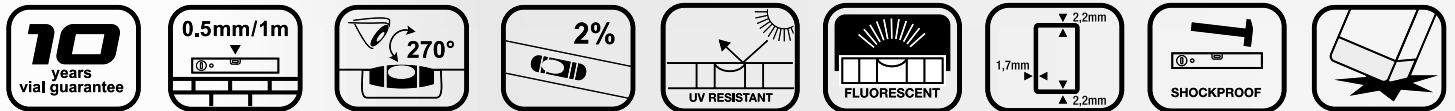

NEW

FESTA
VÍZMÉRTÉK
3 LIBELLÁS



R.sz.	Leírás	
15754	400 mm	1
15756	600 mm	1
15758	800 mm	1
15760	1000 mm	1
15762	1200 mm	1
15768	1800 mm	1
15770	2000 mm	1



NIVELA

VÍZMÉRTÉK NIVELA

- Pontosság 0,5 mm | 1 m
- UV stabil folyadékok a vízszintmérőbe
- ütészálló gumi végződés
- bevonat vastagsága 1,2m



So.	leírás	
15904	40 cm	30
15906	60 cm	30
15908	80 cm	30
15910	100 cm	30
15912	120 cm	20
15915	150 cm	10
15920	200 cm	20



SÁRGA VÍZMÉRTÉK, 3 LIBELLÁS

ALU HOBBY

So.	leírás	
15954	40 cm	60
15956	60 cm	60
15958	80 cm	60
15960	100 cm	30
15962	120 cm	30
15965	150 cm	30
15970	200 cm	30



ZSINOR VÍZMÉRTÉK



So.	leírás	
15981		1



So.	leírás	
15980	230 mm	1

MÁGNESES VÍZMÉRTÉK, 3 LIBELLÁS

VÍZMÉRTÉK OSZLOPHOZ

- 3 libellás mágneses rögzítő



So.	leírás	
26028		12



SLAGVÍZMÉRTÉK TÖMLŐVEL



So.	leírás	
15992	üveg csövek - tömlő 10 m	1
15993	üveg csövek - tömlő 15 m	1
15990	slagvízmérték üveg	50
15991	slagvízmérték műanyag	50



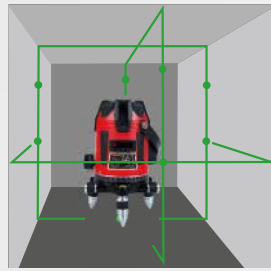
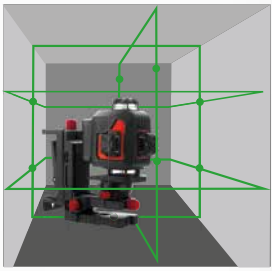

FESTA

LASER ALL LINE GREEN 4 X 360 °

- 2x vízszintes sík + 2x függőleges sík (zöld sugár)
- önszintezési tartomány ±4°
- pontosság: 0,2 mm/m
- beltéri: 30 m, kültéri érzékelővel 50 m
- impulzus üzemmód – ajánlott kiegészítő vevő 26209
- tartalmazza: hordtáska, távirányító, lézeres célpont, Li-ion akkumulátor, 5200 mAh, professzionális konzol, mini állvány, töltő

±4°	max. 50m	±0.2 mm/m	II. class	515 nm
1/4"	5/8"	IP54	Li-ion 3.7V 5.2Ah	

R.s. Leírás 1

26205

1



FESTA

CROSS-LINE GREEN LÉZER

- 1x vízszintes sík + 4x függőleges sík (zöld sugár) + 1x pont
- önszintezési tartomány ±3°
- pontosság: 0,2 mm/m
- beltéri: 20 m, kültéri érzékelővel 50 m
- impulzus üzemmód – ajánlott kiegészítő vevő 26209
- tartalmazza: hordtáska, lézeres célpont, Li-ion akkumulátor, 5200 mAh, professzionális konzol, mini állvány, töltő

±3°	max. 50m	±0.2 mm/m	II. class	515 nm
5/8"	IP54	Li-ion 3.7V 5.2Ah		

R.s. Leírás 1

26203

1



**FESTA****LASER ALL LINE GREEN 3 X 360 °**

- 1x vízszintes sík + 2x függőleges sík (zöld sugár)
- önszintezési tartomány $\pm 4^\circ$
- pontosság 0,2 mm/m
- beltéri: 30 m, kültéri érzékelővel 50 m
- impulzus üzemmód – ajánlott kiegészítő vevő 26209
- tartalmazza: hordtáska, 4xAA alkáli elem, lézeres célpont, szemüveg, 2600 mAh Li-ion akkumulátor, professzionális konzol, töltő, Li-ion akkumulátor bölcsoje

$\pm 4^\circ$	INDOOR 30 m OUTDOOR 50 m	± 0.2 mm/m	II. class	515 nm
IP54	5/8"	1/4"	4x AA	Li-ion 7.4V 2.6Ah



R.sz. 26204
Leírás green

1

**FESTA****CROSS-LINE GREEN LÉZER**

- 1x vízszintes sík + 1x függőleges sík (zöld sugár)
- önszintezési tartomány $\pm 3^\circ$
- pontosság 0,2 mm/m
- beltéri: 20 m, kültéri érzékelővel 50 m
- impulzus üzemmód – ajánlott kiegészítő vevő 26209
- tartalmazza: hordtáska, 2xAA alkáli elem, konzol

$\pm 3^\circ$	INDOOR 20 m OUTDOOR 50 m	± 0.2 mm/m	II. class	515 nm
IP54	1/4"	2x AA		

R.sz. 26201
Leírás

1

FESTA**TÁVOLSÁGMÉRŐ**

- mérési tartomány 0,05 - 50 m
- mérési pontosság ± 2 mm, mértékegység mm/in/ft
- folyamatos mérés, területmérés, térfogatmérés, háromszög láb mérés, LCD FSTN, összeadás/kivonás, max./min. mérőment, max tárhely 100 egység, háttérvilágítás, lézer osztály 630-670 nm, 2. osztály
- üzemi hőmérséklet 0 - 40°C
- mérete 112 x 50 x 25 mm, súlya 90 g
- tartalmazza: hordtáska, 2xAAA alkáli elem

max 50 m	± 2 mm	m in ft	630 670 nm
IP54	2x AAA		

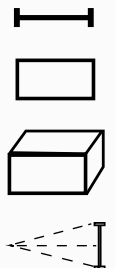

R.sz. 26211
Leírás

1



1/4" + 5/8"



60 - 150 cm

FESTA

LÉZER VEVŐ

- impulzusos lézeres eszközökkel való használatra a hatótávolság 50 m-re történő kiterjesztésére
- beleértve: 9 V-os elem, konzol
- 26201, 26203, 26204, 26205 esetén

max 50 m	±1.5 mm 10 m	5 kHz	IP54	1x 9V
--------------------	------------------------	--------------	-------------	--------------



ALU



So.	leírás	
26209	range: 50 m	1

So.	leírás	
26219	60 - 150 cm 1/4" + 5/8"	1

FESTA

DIGITÁLIS DŐLÉSMÉRŐ

- 0° - 360°
- Pontosság ±0,1°
- felbontás 0,1°
- automatikus kikapcsolás funkció
- HOLD funkció a mért érték tárolásához
- háttérvilágítás kijelző
- méretei 60x60x25 mm
- elem 1xAAA



· bag

mágneses talp

0.1°	0.1°	1x AAA	0-50°C	82g
-------------	-------------	---------------	---------------	------------

So.	leírás	
26218		1

So.	leírás	
		1



FESTA

DIGITÁLIS SZÖGMÉRŐ

200 mm	mm inch	LCD DISPLAY	0°-360°
0.05°	+/- 0.2°	MANUAL LOCKING	1x CR2032 3V



FESTA

NIVELA DIGITÁLIS VÍZMÉRTÉK DL

- LCD Kijelző
 - Méri tartomány
 - Megkülönböztetés
 - Pontosság
- 0° - 225°
0,1°
± 0,3

ALU	0.1°	3V LITHIUM
------------	-------------	-------------------



So.	leírás	
26217	200 mm	1

So.	leírás	
26216	300 mm	1

FESTA**MULTIMÉTER**

- DC feszültség mérés: 200 mV - 300 V
 AC feszültségmérés: 200 mV - 300 V
 Egyenáram mérés: 2000 μ A - 10 A
 · ellenállásmérés: 200 Ω - 2 M Ω
 · akkumulátor ellenőrzés: 1,5 V, 9 V
 · lemerült akkumulátor jelzés
 · túlterhelés elleni védelem

- IEC61010
 · CATIII 300 V
 · GS tanúsítvány
 · Tápellátás: 9 V-os elem (6F22)
 · méretek: 70x128x28 mm
 · súly: 137 g (akkumulátorral)
 tartozékok: tesztkábelek



So. leírás

18429



1

**FESTA****FESZÜLTÉSGVIZSGÁLÓ**

- AC/DC - 6 V, 12 V, 24 V, 50 V, 120 V, 230 V, 400 V
 · vízállóság IP54
 · polaritás meghatározása
 · CAT III 400V



So. leírás

18428



1

**Laserliner®****LUXTEST-MASTER**

Professzionális fényerősségmérő készülék

- Fényintenzitás mérése munkahelyeken, irodákban, középületekben és iparban
 · Érzékeny fotodiódák cosinus korrekcióval a széles rű fényméréshez
 · Relatív mérési funkciók referenciaméréshez és összehasonlításához
 · Magasszintű funkció a gyors változás regisztrálásához a megvilágítás szintjén.
 · Értékek automatikus memorizációjának funkciója.
 · Automatikus és kézi kapcsolás
 · Nullázási funkció
 · Változó mérés: Lux (lm | m2), lábpedál gyertyák (lm | ft2) - Min | max kijelző
 · 1/4" állvány



So. leírás

	Mérési tartomány:	20 Lux ... 200000 Lux
26520	Pontosság:	$\pm 3\%$ (referencia izzót 2854 K)
	Cosinus szögeltérés:	$\pm 2\%$ (30°), $\pm 6\%$ (60°)



1

leírás

Tartozékok: elemek, hordtáska

Laserliner®**AIRFLOWTEST-MASTER**

Professzionális anemométer a légáramlás, a térfogatáram és a szélsősebesség méréseire

- Integrált érzékelő a környezeti hőmérséklet, relatív páratartalom és harmatpont méréseire
 · USB interfész a mért adatok tárolására
 · PC szoftver - Nagy lapátkerék: 65 mm.
 · Min. | Max. kijelző. - 1/4"-os menet az állványra csatlakoztatás hosszútávú mérésehez
 · Világítás, áttekinthető kijelző, állandóan látható értékekkel a környezeti hőmérsékletről és relatív páratartalomról



So. leírás

	Áramlási sebesség:	0.80...30 m s $\pm 2\%$
26521	Környezeti hőmérséklet:	-10...60°C $\pm 1.5^\circ\text{C}$
	Relatív páratartalom:	20%...80% $\pm 3\%$
	Légáramlat:	0...99990 CMM



RECORDING ON A PC

leírás

Tartozékok: Airflow Test-Master, PC szoftver, USB kábel, elemek, hordtáska



1



FESTA

ÁCSCERUZA HB



MOQ
12

So.	leírás	MOQ
13270	HB · 180 mm	96
13271	HB · 180 mm · készlet 3 db	32
13265	HB · 250 mm	96



FESTA

ÁCSCERUZA HB



MOQ
50



So.	leírás	MOQ
13269	HB · 180 mm	50
13266	HB · 250 mm	50



FESTA

ÁCSCERUZA HB



MOQ
12

So.	leírás	MOQ
13272	HB · 250 mm	96
13264	HB · 250 mm · nyomtatás nélkül	96



FESTA

ÁCSCERUZA HB

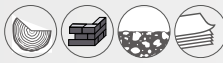

MOQ
50



So.	leírás	MOQ
13268	250 mm	50



FESTA

HÁROMSZÖG ALAKÚ ÁCSCERUZA HB



MOQ
12

So.	leírás	MOQ
13278	250 mm	96



FESTA

ÁCSCERUZA 6H

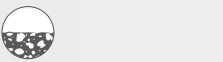

MOQ
12

So.	leírás	MOQ
13275	6H · 250 mm	96



FESTA

ÜVEGRE ÉS KERÁMIÁRA



MOQ
12

So.	leírás	MOQ
13273	175 mm, piros grafit - üvegre és kerámiára	144



FESTA

ÁCSCERUZA



MOQ
12

So.	leírás	MOQ
13274	175 mm, kétszínű	96



ÁCSCERUZA HB



MOQ
12

So.	leírás	
13280	180 mm	96



ÁCSCERUZA PIROS SZÍNŰ

So.	leírás	
13276	175 mm	144



csiszolópapír

CERUZAHEGYZŐ

So.		
13261		12



FESTA

JELŐLŐ CERUZA, FÉM, HB GAFIT BETÉTEL

ceruza 13263, 13267



R.s.	leírás	
13288		20



FESTA

JELŐLŐ CERUZA, FÉM, HB GAFIT BETÉTEL

ceruza 13263, 13267



So.	leírás	
13262	150 mm	20



FESTA

CERUZA CSERÉLHETŐ HEGGYEL



So.	leírás	
13279	ceruza + tartalék hegy HB	24
13284	5 db tartalék hegy	20



FESTA

SZÍNES CERUZA

13262, 13288 -ért



Č.p.	Specifikace	
13267	2x žlutá 2x červená 2x modrá	1



FESTA

FEKETE CERUZA HB

13262, 13288 -ért



Č.p.	Specifikace	
13263	6x černá	20





ALKOHOLOS FILCTOLL



R.sz.	Leírás	
13200	○ fehér	1
13201	● fekete	1
13202	● piros	1



NEW

ALKOHOLOS FILCTOLL



- extra erős tipp
- Zsíros és nedves felületek jelölésére is



So.	leírás	
13216	piros	12
13217	fekete	12
13218	kék	12
13219	zöld	12



ALKOHOLOS FILCTOLL



- 2 típusú jelölő tipp
- Zsíros és nedves felületek jelölésére is



So.	leírás		
13227	fehér	ALU	40
13222	fehér	PVC	12
13228	piros	ALU	40
13229	fekete	ALU	40
13230	kék	ALU	12
13231	zöld	ALU	12



ALKOHOLOS FILCTOLL



So.	leírás	
13214	fehér	12
13225	piros	12
13226	fekete	12
13223	kék	12
13224	zöld	12



ALKOHOLOS FILCTOLL



So.	leírás	
13235	piros	12
13236	fekete	12
13237	kék	12
13238	zöld	12



FESTA

ALKOHOLOS FILCTOLL



So.	Leírás	
13246	● fekete	1
13247	● piros	1
13248	○ fehér	1



ALKOHOLOS FILCTOLL - 2 HEGYŰ

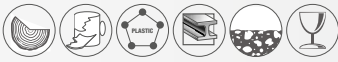

So.	Leírás	
13206	○ fehér	12



ALKOHOLOS FILCTOLL - 2 HEGYŰ



So.	leírás	
13212	fekete	12



ALKOHOLOS FILCTOLL - 2 HEGYŰ



So.	Leírás	
13207	● piros	12
13208	● kék	12



ALKOHOLOS FILCTOLL MINI



· hossz 9 cm



So.	leírás	
13205	● ● ● ● ●	72

**FESTA****ZSÍRKRÉTA KÉSZLET**

5 DB

· Ø 13 x 110 mm

5x

So.	leírás	
13240	5 szín	20
13241	piros	20
13242	fekete	20

So.	leírás	
13243	sárga	20
13244	zöld	20
13245	fehér	20

**GURULÓ JELÖLŐFESTÉK TARTÓ**

· permetezéshez Trackmarker a Fluo

MADE IN EU

So. leírás

13296



1

**ZSÍRKRÉTA KÉSZLET 6 DB****6x**

So. leírás

13277

● ● ● ● ● ●

88

**KRÉTA, FEHÉR****12x**

So. leírás

13260

12 x 12 x 80 mm

46

**JELÖLŐFESTÉK TARTÓ PISZTOLY**

· permetezéshez Trackmarker a Fluo

MADE IN EU

So. leírás

13295



1



SPRAY FLUORESZKÁLÓ TRACKMARKER 500ML

- Nagyfokú láthatóság a fluoreszkáló pigment miatt
- Biztonsági kupak
- Gyors száradás 10 perc.
- Tartósság 3 hónap
- Használat - beton, aszfalt, fű, kavics, homok, kő, fa



So.	leírás	
13250	● sárga	12
13251	● piros	12
13252	● narancs	12
13253	● zöld	12
13254	● rózsaszín	12
13249	● kék	12



SPRAY FLUORESZKÁLÓ MARK 6M FLUO 500 ML

- Nagyfokú láthatóság a fluoreszkáló pigment miatt
- Biztonsági kupak
- Gyors száradás 10 perc.
- Tartósság 6 hónap
- Használat - beton, aszfalt, fű, kavics, homok, kő, fa



So.	leírás	
13360	● sárga	12
13361	● piros	12
13362	● narancs	12
13363	● zöld	12
13364	● rózsaszín	12
13365	○ fehér	12



SPRAY FLUORESZKÁLÓ FLUO 500 ML

- Nagyfokú láthatóság a fluoreszkáló pigment miatt
- Biztonsági kupak
- Gyors száradás 10 perc.
- Tartósság 12 hónap
- Használat - beton, aszfalt, fű, kavics, homok, kő, fa



So.	leírás	
13350	● sárga	12
13351	● piros	12
13352	● narancs	12
13353	● zöld	12
13354	● rózsaszín	12
13355	○ fehér	12



SPRAY FLUORESZKÁLÓ IDEAL 500 ML

- Nagyfokú láthatóság a fluoreszkáló pigment miatt
- Biztonsági kupak
- Gyors száradás 10 perc.
- Tartósság 12 hónap
- Használat - beton, aszfalt, fű, kavics, homok, kő, fa



So.	leírás	
13255	● sárga	12
13256	● piros	12
13257	● narancs	12
13258	● zöld	12
13259	● rózsaszín	12



KDS®

KDS japán törhető pengés kések

- kiváló ergonomikus fogás
- nagy teljesítményű és hosszú élettartamú pengék
- legjobb anyagból készült pengék
- kis vágási ellenállás

**KDS®**
TÖRhető PENGÉS KÉS

R.sz.	leírás		
16002	LC405	18 mm zöld	25
16011	LB10	Tartalék penge	10

**KDS®**
TÖRhető PENGÉS KÉS

R.sz.	leírás		
16003	G11	18 mm + 2 penge	10
16012	GB10	pót pengék	10

**KDS®**
TÖRhető PENGÉS KÉS

R.sz.	leírás		
16019	L19	18 mm + 2 penge	10
16011	LB10	pót pengék	10
16012	GB10	pót pengék	10

**KDS®**
TÖRhető PENGÉS KÉS

R.sz.	leírás		
16004	H11	25 mm	10
16013	HB10	Tartalék penge	10

**KDS®**
TÖRhető PENGÉS KÉS

R.sz.	leírás		
16005	S14	9 mm + 2 penge	10
16010	SB10	Tartalék penge	10

**KDS®**
TÖRhető PENGÉS KÉS

R.sz.	leírás		
16006	D12	+ 16 penge	10

KDS®
PÓT PENGÉK

10x

R.sz.	leírás		
16010	SB10	9 0,38 mm	13 szegmens
16011	LB10	18 0,5 mm	15 szegmens
16012	GB10	18 0,6 mm	15 szegmens
16013	HB10	25 0,7 mm	7 szegmens

**KDS®**
PÓT PENGÉK

- Speciális ötvözet
- Kétszeres fenés
- Emelt élettartalom
- Alacsony vágási ellenállás könnyű vágást tesz lehetővé

10x

R.sz.	leírás		
16016	LB10B	18 0,5 mm	8 szegmens
16017	HB10B	25 0,7 mm	7 szegmens

**KDS®**
KDS REKLÁM ÁLLVÁNY

R.sz.	leírás	
16999	Reklám állvány	1
16998	Feltöltött állvány áruval	1



- Elemek az állványban 16998 : 16001 · 5 db
- 16003 · 5 db
- 16004 · 3 db
- 16005 · 3 db
- 16006 · 2 db
- 16008 · 3 db
- 16010 · 4 db
- 16012 · 4 db
- 16016 · 4 db
- 16013 · 1 db
- 16018 · 4 db
- 16019 · 4 db
- 16020 · 4 db

· szemléltető foto



FESTA





TÖRHEŐ PENGÉS KÉS

· Csúszásgátló gumi bevonat

R.sz.	leírás	
16099	18 mm	12

FESTO



KERÁMIA PENGÉS KÉS

· 3x élesebb mint az acél pengék
· 10x hosszabb élettartam
· garanciabiztos, nem mágnesezhető, nem vezető

R.sz.	leírás	
16131	18 mm	10
16066	Tartalék penge 18 mm, 5 db	10



TÖRHEŐ PENGÉS KÉS

R.sz.	leírás	
16110	L11 18 mm + 1 penge	12



TÖRHEŐ PENGÉS KÉS

R.sz.	leírás	
16100	L12 18 mm + 1 penge	12

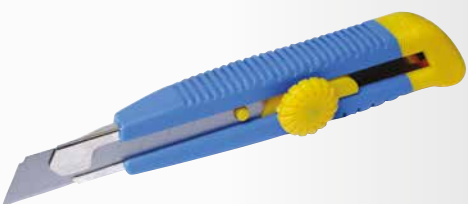

TÖRHEŐ PENGÉS KÉS

R.sz.	leírás	
16105	L17 18 mm + 1 penge	12



TÖRHEŐ PENGÉS KÉS

R.sz.	leírás	
16125	L4 9 mm	24
16120	L8 18 mm	24



TÖRHEŐ PENGÉS KÉS

R.sz.	leírás	
16115	L10 9 mm	24



FESTA
TÖRHEŐ PENGÉS KÉS

ALU			
R.s.	leírás		
16150	18 mm		24
16151	18 mm nyomtatás nélkül FESTA		20



FESTA
TÖRHEŐ PENGÉS KÉS

ALU			
R.s.	leírás		
16136	18 mm		12



FESTA
TÖRHEŐ PENGÉS KÉS

ALU			
R.s.	leírás		
16137	25 mm		12



FESTA
TÖRHEŐ PENGÉS KÉS

· Csúszásgátló gumi bevonat

+4 ALU			
R.s.	leírás		
16090	18 mm		12



FESTA
TÖRHEŐ PENGÉS KÉS

· Csúszásgátló gumi bevonat

+4 ALU			
R.s.	leírás		
16091	25 mm		6



FESTA
TÖRHEŐ PENGÉS KÉS

· Csúszásgátló gumi bevonat

ALU			
R.s.	leírás		
16145	L25 18 mm		12



FESTA
TÖRHEŐ PENGÉS KÉS

· Csúszásgátló gumi bevonat

ALU			
R.s.	leírás		
16144	L24 18 mm		12



TÖRHEŐ PENGÉS KÉS

ALU			
R.s.	leírás		
16143	18 mm		12



TÖRHEŐ PENGÉS KÉS

ALU			
R.s.	leírás		
16142	18 mm		12



TÖRHEŐ PENGÉS KÉS

ALU			
R.s.	leírás		
16025	18 mm		12



FESTA
TÖRHEŐ PENGÉS KÉS

ALU			
R.s.	leírás		
16029	18 mm		25



FESTA
TÖRHEŐ PENGÉS KÉS

· Csúszásgátló gumi bevonat

ALU			
R.s.	leírás		
16146	18 mm		12



FESTA

TÖRHEŐ PENGÉS KÉS

· Csúszásgátló gumi bevonat



R.sz.	leírás	
16147	25 mm	12



FESTA

TÖRHEŐ PENGÉS KÉS

· Csúszásgátló gumi bevonat



R.sz.	leírás	
16130	L18 18 mm + 5 pótpenge	12



FESTA

TÖRHEŐ PENGÉS KÉS

· Csúszásgátló gumi bevonat



R.sz.	leírás	
16135	L20 25 mm + 5 pótpenge	6



FESTA

TÖRHEŐ PENGÉS KÉS

· Csúszásgátló gumi bevonat



R.sz.	leírás	
16140	L22 18 mm	12



FESTA

TÖRHEŐ PENGÉS KÉS

· Csúszásgátló gumi bevonat



R.sz.	leírás	
16034	25 mm	12



FESTA

TÖRHEŐ PENGÉS KÉS



R.sz.	leírás	
16085	9 mm	24

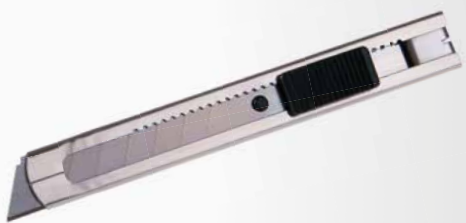

FESTA

TÖRHEŐ PENGÉS KÉS



R.sz.	leírás	
16086	18 mm	24



BIZTONSÁGI KÉS

R.sz.	leírás	
16044		20



BIZTONSÁGI KÉS

· önhúzódó pengék

R.sz.	leírás	
16057	135 mm	12



FESTA

BIZTONSÁGI KÉS



R.sz.	leírás	
16058		6
16074	Tartalék penge 10 db	1

16074



NEW



FESTA

ÖSSZECSUKHATÓ KÉS - KAPARÓ

+2 SK4



R.sz.	Leírás	
16039		6
16087	Tartalék penge	1



FESTA

TÖRHEŐ PENGÉS KÉS

+5 ALU



R.sz.	leírás	
16037		6



FESTA

ÖSSZECSUKHATÓ KÉS

+5 ALU



R.sz.	leírás	
16023	+ 5 pótpenge	12
16071	Tartalék penge 10 db	10



FESTA

LINÓLEUM VÁGÓKÉS

ALU

R.sz.	leírás	
16095	25 pótpenge	1

DEKOR SZIKE KLT.

22x



R.sz.	leírás	
16282		24



DEKOR SZIKE KLT.

13x



R.sz.	leírás	
16281		10



FESTA

LINÓLEUM VÁGÓKÉS

Csúszásgátló gumi bevonat

ALU +2



R.sz.	leírás	
16035	+ 2 pótpenge	12

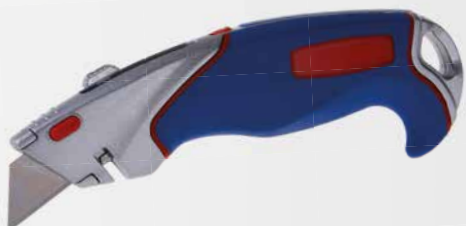

FESTA

LINÓLEUM VÁGÓKÉS

ALU +3



R.sz.	leírás	
16033	NP 110 + 3 pótpenge	5





LINÓLEUM VÁGÓKÉS

ALU



R.sz.	leírás	
16032	NP 109	48



LINÓLEUM VÁGÓKÉS

ALU



R.sz.	leírás	
16031	NS 107 B	24



LINÓLEUM VÁGÓKÉS

ALU



R.sz.	leírás	
16030	NS 107	24



TÖRHEŐ PENGÉS KÉS

ALU



R.sz.	leírás	
16046	18 mm	12



TÖRHEŐ PENGÉS KÉS

ALU



R.sz.	leírás	
16028	S 201 18 mm	24



TÖRHEŐ PENGÉS KÉS

ALU



R.sz.	leírás	
16026	P 205 18 mm	30



TÖRHEŐ PENGÉS KÉS

HOBBY



R.sz.	leírás	
16021	P 201 9 mm	60



TÖRHEŐ PENGÉS KÉS

HOBBY



R.sz.	leírás	
16024	P 204 18 mm	60

TÖRHEŐ PENGÉS KÉS
24 DB

HOBBY



R.sz.	leírás	
16141	18 mm	24

Csúszásgátló gumi bevonat

MOQ
24

KÉS KLT.

HOBBY 12x



R.sz.	leírás	
16053	9 mm	12
16055	18 mm	12



KÉS KLT.

HOBBY 3x



R.sz.	leírás	
16043		24





KÖRPENGÉS KÉS

szőnyegekhez és padlókhöz



R.sz.	leírás	
16036	45 mm	12



SZŐNYEGPADLÓVÁGÓ KÉS, HORGAS

szőnyegekhez és padlókhöz



R.sz.	leírás	
16041		12



50 mm

KAPARÓ

ALU



R.sz.	leírás	
16059	50 mm	10
16082	pót pengék	1



100 mm

KAPARÓ

18 mm-es pengékkel való használatra letörő késekhez

ALU



R.sz.	leírás	
16054	100 mm	1



100 mm

MEGHOSSZABÍTOTT KAPARÓ



R.sz.	leírás	
16052	48 cm hossz	6
16070	pót pengék	25



38 mm

FESTA

KAPARÓ

Csúszásgátló gumi bevonat



R.sz.	leírás	
16049		12
16069	pót pengék	1



60 mm

KAPARÓ



R.sz.	leírás	
16051		24



55 mm

KAPARÓ



R.sz.	leírás	
16050		24



FÚGÁZÓ KLT.

3x



R.sz.	leírás	
16042		12





FESTA

PÓT PENGÉK

- 7 szegmens
- 3x hosszabb élettartam
- dupla csiszolás
- alacsony vágási ellenállás



R.s.	leírás	
16064	25 0,7 mm	20

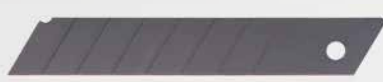

FESTA

PÓT PENGÉK

- 8 szegmens
- 3x hosszabb élettartam
- dupla csiszolás
- alacsony vágási ellenállás



R.s.	leírás	
16062	18 0,7 mm	10



FESTA

PÓT PENGÉK

- 15 szegmens
- 3x hosszabb élettartam
- dupla csiszolás
- alacsony vágási ellenállás

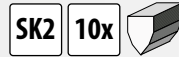

R.s.	leírás	
16063	18 0,7 mm	10



FESTA

KERÁMIA PÓT PENGÉK

- 8 szegmens
- 3x élesebb mint az acél pengék
- 10x hosszabb élettartam
- garanciabiztos, nem mágnesezhető, nem vezető



R.s.	leírás	
16066	18 0,6 mm	10



PÓT PENGÉK

- 8 szegmens
- dupla csiszolás



R.s.	leírás	
16078	18 0,5 mm	25



PÓT PENGÉK

- 8 szegmens
- dupla csiszolás



R.s.	leírás	
16077	18 0,6 mm	25



PÓT PENGÉK

- 7 szegmens



R.s.	leírás	
16068	25 0,6 mm	20



PÓT PENGÉK

- 8 szegmens



R.s.	leírás	
16065	18 0,5 mm	60



PÓT PENGÉK

- 15 szegmens



R.s.	leírás	
16081	18 0,5 mm	60



PÓT PENGÉK

- 4 szegmens



R.s.	leírás	
16067	18 0,5 mm	10



PÓT PENGÉK 30°

- 7 szegmens



R.s.	leírás	
16061	9 0,4 mm	60



PÓT PENGÉK

- 13 szegmens



R.s.	leírás	
16060	9 0,45 mm	10



FESTA

PÓT PENGÉK



R.s.	leírás	
16072	R 004	10



FESTA

PÓT PENGÉK



R.s.	leírás	
16075	R 003	10



PÓT PENGÉK



R.s.	leírás	
16071	R 001	60

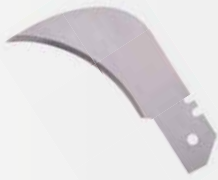

PÓT PENGÉK

5x

R.sz.	leírás	
16083	18 mm	50



PÓT PENGÉK

10x

R.sz.	leírás	
16073	R.002	60



PÓT PENGÉK

5x

R.sz.	leírás	
16084	18 mm	50

FESTA

PÓT PENGÉK

· mert 16058

10x

R.sz.	leírás	
16074		1



PÓT PENGÉK

· mert 34315

R.sz.	leírás	
34316		1



PÓT PENGÉK

· mert 16052

R.sz.	leírás	
16070	100 mm	25



FESTA

KÉS ÁSVÁNYGYAPOTRA

R.sz.	leírás	
16198	44,5 33 cm	12

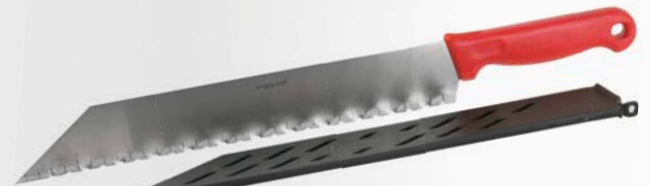

FESTA

ÁSVÁNYGYAPOT,
POLISZTIROL VÁGÓ KÉS

· ásványgyapot, polisztirol

R.sz.	leírás	
16199	48 35 cm	10



FESTA

BOZÓTVÁGÓ

R.sz.	leírás	
45069	490 mm	6

TEFLON



FESTA

BOZÓTVÁGÓ

R.sz.	leírás	
44950	490 mm	4

TEFLON



BOZÓTVÁGÓ

R.sz.	leírás	
45083	430 mm	12
45084	600 mm	6

INOX



BOZÓTVÁGÓ

· fogantyú kőrisből készült

R.sz.	leírás	
45081	510 mm	36
45082	710 mm	36

**FESTA****KÉS**

- nejlon markolat
- teflon bevonatú penge
- övre akasztható tok, biztosító



INOX	TEFLON	NYLON	R.s.	leírás	
			16234	21 10 cm	10

**FESTA****VADÁSZKÉS**

INOX	TEFLON	R.s.	leírás	
		16229	23 10 cm	12

**FESTA****MULTIFUNKCIÓS VÉSŐ**

- vastagított penge



INOX	R.s.	leírás	
	16231	20 8 cm	12

MOQ
12

12

**MŰSZAKI KÉS, ERŐSÍTETT PENGÉVEL, TOKKAL**

- vastagított penge

INOX	R.s.	leírás	
	16230	21 10 cm	12

**FESTA****LINÓLEUM VÁGÓKÉS**

R.s.	leírás	
16225	20 8,5 cm	12

**FESTA****KÉS**

- vastagított penge

INOX	R.s.	leírás	
	16212	15 3,2 cm	12

**FESTA****KÉS**

R.s.	leírás	
16201	Ø 8 - 27 mm	10

**FESTA****KÉS**

INOX	R.s.	leírás	
	16211	20 8,5 cm	10

**FESTA****KÉS**

INOX	R.s.	leírás	
	16210	20,5 9 cm	10



FESTA

KÉS



INOX

R.s. leírás
16219 19 | 11 cm

24



FESTA

KÉS



INOX

R.s. leírás
16218 18,5 | 10,5 cm

24



FESTA

KÉS



INOX

R.s. leírás
16220 18,5 | 11 cm

24



FESTA

KÉS



INOX

R.s. leírás
16235 17,5 | 8,5 cm

24



FESTA

KÉS



INOX

R.s. leírás
16221 21 | 12 cm

24



FESTA

KÉS



INOX

R.s. leírás
16236 22,5 | 10 cm

24



FESTA

KÉS



INOX

R.s. leírás
16209 14,5 | 5,5 cm

1



FESTA

KÉS



INOX

R.s. leírás
16222 20 | 12 cm

24



FESTA

KÉS



INOX **ALU**

R.s. leírás
16223 18,5 | 10,5 cm

24



FESTA

KÉS

· 5 funkció

INOX

R.s. leírás
16228 27 | 10,5 cm



24



FESTA

KÉS

· 10 funkció

INOX

R.s. leírás
16226 17,5 | 7 cm



24



KÉS

· 7 funkció

INOX

R.s. leírás
16224 17,5 | 7 cm



24



KÉS

· 3 funkció

INOX

R.s. leírás
16227 20,5 | 10 cm



24



FESTA

MULTIFUNKCIÓS FOGÓ

· 9 funkció

· Eset

CrV

R.s. leírás
16232



12

NEW

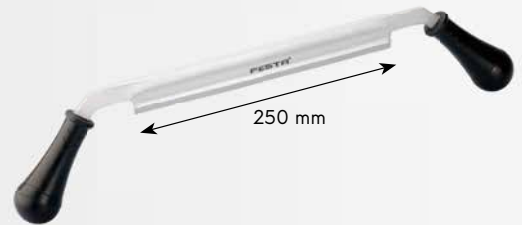

FESTA

VONÓKÉS

CrV

R.s. leírás
24132 250/490 mm



1



GYALU



R.s. leírás
19510 220 x 65 x 130 mm, kés 48 mm 1



GYALU



R.s. leírás
19515 200 x 55 x 130 mm, kés 39 mm 1



GYALU



R.s. leírás
19520 225 x 27 x 155 mm, kés 27 mm 1



FESTA

FAVÉSŐ

CrV

R.sz.	leírás	
19490	6 mm 290 mm	6
19491	8 mm 290 mm	6
19492	10 mm 290 mm	6
19493	12 mm 290 mm	6
19494	14 mm 290 mm	6
19495	16 mm 290 mm	6



FESTA

MULTIFUNKCIÓS FAVÉSŐ

INOX

R.sz.	leírás	
16231	20 80 mm	12



MOQ
12



FESTA

FAVÉSŐ KLT. FENŐKŐVEL

CrV

5x

R.sz.	leírás	
19451	6 mm 10 mm 15 mm 20 mm 25 mm	10



FESTA

FAVÉSŐ KLT.

CrV

4x

R.sz.	leírás	
19457	6 mm 12 mm 19 mm 25 mm	10



FAVÉSŐ KLT.

4x

R.sz.	leírás	
19455	8 mm 12 mm 19 mm 25 mm	30

FESTA



FESTA

FAVÉSŐ KLT.

CrV

8x

R.sz.	leírás	
19458	365 125mm	1



FAVÉSŐ KLT.

4x

R.sz.	leírás	
19450	8 mm 12 mm 19 mm 25 mm	20



FAVÉSŐ KLT.

12x CrV

R.sz.	leírás	
19459		5

FESTA

ÉLEZŐ 16v1



	30° Anvil	
	45° Anvil	
	50° Anvil	
	23° Bypass	
	35° Bypass	
	65° Bypass	
	Deburrr Tool	



R.s. leírás

45073



1



FENŐKŐ, KERÉKÍTETT

R.s.	leírás	
45370	250 x 33 x 18 mm	20

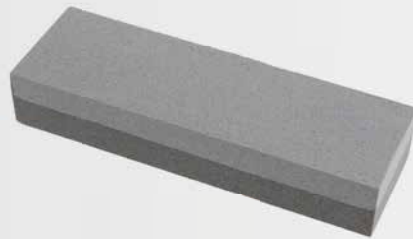

FENŐKŐ

R.s.	leírás	
45045	150 x 50 x 30 mm	1



FENŐKŐ

R.s.	leírás	
45046	205 x 15 mm	100



KÉS ÉS OLLÓ ÉLEZŐ

R.s.	leírás	
16991		20



KÉS ÉS OLLÓ ÉLEZŐ

R.s.	leírás	
16990	Ø 50 mm	1



KÉS ÉS OLLÓ ÉLEZŐ

R.s.	leírás	
45048		20



KÉS ÉS OLLÓ ÉLEZŐ 6 IN 1

R.s.	leírás	
45068		10



WINLAND



WINLAND



FESTA
POWER X TOOLS

CSŐ HEGESZTŐ

- tápfeszültség 230 V / 50 Hz
- teljesítmény 750 / 1500 W
- hőmérséklet 0-300 C°
- átmérők Ø 20,25,32,40,50,63 mm
- tömeg 1,6 kg



· a szerszámtartó tartalmaz mérőszalagot, vízmértéket, csavarhúzó, imbuszkulcs 6 hegesztő adapter, állvány, hordozó tok



R.sz.	Leírás	Mennyiség
17182		1



FESTA
POWER X TOOLS

CSŐ HEGESZTŐ

- tápfeszültség 230 V / 50 Hz
- teljesítmény 800 / 1000 W
- hőmérséklet 0-300 C°
- átmérők Ø 16, 20, 25, 32 mm
- tömeg 1 kg



· a szerszámtartó tartalmaz imbusz kulcsot, 4 hegesztő adapter, állvány, hordozó tok



R.sz.	Leírás	Mennyiség
17183		1

FESTA

PVC CSŐ VÁGÓ

Ø max.
42 mm



R.sz.	Leírás	Mennyiség
17027		10
16315	Tartalék penge	1



TARTALÉK PENGE 17027-HEZ

· mert 17027

R.sz.	Leírás	Mennyiség
16315		1



FESTA



FESTA

PVC CSŐ VÁGÓ

Ø max.
32 mm



R.sz.	Leírás	Mennyiség
17037		12



PVC CSŐ VÁGÓ

Ø max.
42 mm



R.sz.	Leírás	Mennyiség
17026		6



NEW

FESTA

CSŐ VÁGÓ

INOX ALU

ALU Cu PVC

R.sz.	Leírás	
16305	Ø 22 mm	10
16306	Ø 15 mm	10
16307 NEW	Ø 28 mm	10



NEW

FESTA

PVC CSŐVÁGÓ

PLASTIC INOX

PVC

R.sz.	Leírás	
16308	Ø 20 - 50 mm	10

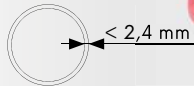

< 2,4 mm

**FESTA**

CSŐVÁGÓ KÉSZLET

Ø 15 mm
Ø 22 mm
Ø 28 mm

3x INOX ALU

ALU Cu PVC

R.sz.	Leírás	
16309		10



FESTA

PVC CSŐ VÁGÓ



R.sz.	leírás	
16301		10
16311	Tartalék penge	1

FESTA

PVC CSŐ VÁGÓ



R.sz.	leírás	
16304		6
16312	Tartalék penge	1

PVC CSŐ VÁGÓ





R.sz.	leírás	
16303		10
16311	Tartalék penge	1

PVC CSŐ VÁGÓ

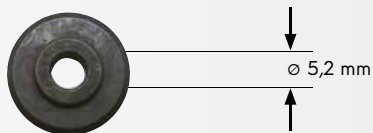

R.sz.	leírás	
16300		10
16310	Tartalék penge	1

TARTALÉK VAGÓKERÉK
PVC CSŐVÁGÓHOZ

R.sz.	leírás	
16310	Ø 17,5 mm x 6 m mert 16300	1
16311	Ø 18,0 mm x 4,5 mm mert 16303, 16301	1
16312	Ø 27,5 mm x 6 mm mert 16304	1

**FESTA**DARABOLÓ OLLÓ,
PROFILOKHOZ

· lecek, csövek, profilok

5x

R.sz.	leírás	
17050	60 250 mm	8

**NEW****FESTA**

CSŐSORJÁZÓ



ALU



R.sz.	leírás	
16319	Ø 6 - 38 mm	1

FESTA

SORJÁZÓ



R.sz.	leírás	
16321		1

CSŐSORJÁZÓ



R.sz.	leírás	
16320		1

FESTA

KÉZI MARÓK



R.sz.	leírás	
20360		10

SORJÁZÓ



R.sz.	leírás	
20361		1



CSAVARHÚZÓ LAPOS

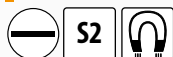

R.sz.	leírás	
18113	3 x 75 mm	12
18114	4 x 100mm	12
18115	5,5 x 125 mm	12
18116	6,5 x 150 mm	12
18118	8 x 175 mm	6
18120	10 x 200 mm	6



CSAVARHÚZÓ LAPOS RÖVID

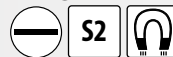

R.sz.	leírás	
18124	5,5 x 38 mm	12
18125	6,5 x 38 mm	12



CSAVARHÚZÓ PHILIPS

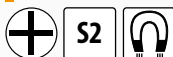

R.sz.	leírás	
18210	0 x 75 mm	12
18211	1 x 75 mm	12
18212	2 x 100 mm	12



CSAVARHÚZÓ PHILIPS RÖVID

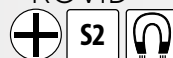

R.sz.	leírás	
18215	1 x 38 mm	12
18216	2 x 38 mm	12



CSAVARHÚZÓ POZIDRIVE

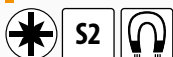

R.sz.	leírás	
18310	0 x 75 mm	12
18311	1 x 100 mm	12
18312	2 x 100 mm	12
18313	3 x 150 mm	6



CSAVARHÚZÓ POZIDRIVE RÖVID

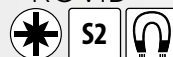

R.sz.	leírás	
18321	1 x 38 mm	12
18322	2 x 38 mm	12



CSAVARHÚZÓ TORX

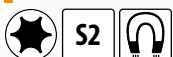

Ç.p.	specifikace	
18350	T6	12
18351	T7	12
18352	T8	12
18353	T9	12
18354	T10	12
18355	T15	12
18356	T20	12
18357	T25	12
18358	T27	12
18359	T30	12
18360	T40	6



CSAVARHÚZÓ + 7 BIT



R.sz.	leírás	
18425		10

- ⊖ S 5 · 6 mm
- ⊕ PH 1 · 2 · 3
- ⊛ T 15 · 20

NEW



CSAVARHÚZÓ KÉSZLET BITEKKEL

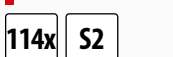

R.sz.	leírás	
18434		1



- bitscavarhúzó
- bitscavarhúzó mini
- csavarhúzó
 - ⊖ 3x75, 5x75, 5x100, 6x100, 6x150, 8x150
 - ⊕ 0x75, 1x75, 1x100, 2x100, 2x150
 - ⊛ T10x75, T15x75
 - ⊖ VDE 2.5x75mm, 4.0x100mm
 - ⊖ zkušeečka napětí
 - ⊖ 2.5x40, 3.0x40mm
 - ⊕ 00x40mm, 0x40mm,
 - ⊛ T6x40mm, T7x40mm
- inbus
 - 1/16", 5/64", 3/32", 1/8", 5/32", 3/16", 7/32", 1/4"
 - 1.5, 2.0, 2.5, 3.0, 4.0, 5.0, 5.5, 6.0mm
- dugókulcs fej
 - 6mm, 7mm, 8mm, 9mm, 10mm, 11mm
- bit
 - ⊖ SL 3mm, 4mm, 4.5mm, 5mm, 5.5mm, 6mm, 7mm, 8mm
 - ⊕ PH0, PH0, PH1, PH1, PH2, PH2, PH3, PH3
 - ⊕ PZ0, PZ0, PZ1, PZ1, PZ2, PZ2, PZ3, PZ3,
 - ⊛ T6, T8, T10, T15, T20, T25, T27, T30, T35, T40
 - H1.5, H2.5, H3.0, H3.5, H4.0, H4.5, H5.0, H5.5, H6, H8
 - ⊖ S0, S1, S2, S3
- bit mini
 - ⊖ SL 1.5mm, 2.0mm, 2.5mm, 3.0mm, 4.0mm
 - ⊕ PH000, PH00, PH0, PH1
 - ⊛ T4, T5, T6, T7, T8, T9, T10, T15, T20
 - H0.7, H0.9



CSAVARHÚZÓ KÉSZLET

⊖ S 3x75 · 5x100 · 6,5x150mm

⊕ PH 0 · 1 · 2 · 3

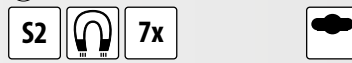

R.s. leírás 6
18402



CSAVARHÚZÓ KÉSZLET

⊖ S 3x75 · 5x100 · 6x150mm

⊕ PH 0 · 1 · 2



R.s. leírás 6
18403



CSAVARHÚZÓ KÉSZLET

⊖ S 6,5x38 · 5,5x75 · 6,5x100 · 8x150 mm
2,5x50 · 3x50 mm

⊕ PH 2x38 · 1x75 · 2x100 · 3x150 mm
0x50 · 00x50 mm

⊛ T 5x50 · 6x50 · 7x50 · 8x50 · 9x50 · 10x50 mm

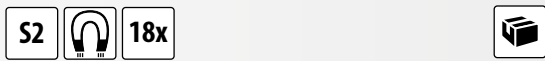

R.s. leírás 6
18424



CSAVARHÚZÓ KÉSZLET

⊖ S 3x75 · 5x100 · 6,5x150 mm

⊛ PZ 0 · 1 · 2



R.s. leírás 6
18404



CSAVARHÚZÓ KÉSZLET TORX

⊛ T 10 · 15 · 20 · 25 · 30



R.s. leírás 6
18340



CSAVARHÚZÓ KÉSZLET

⊖ S 3 x 75 · 4x100 · 5,5x125 · 6,5 x 150mm

⊕ PH1 x 100 · 2 x 100mm

⊙ adapter 1/4"

bits:

⊖ S 4 · 5 · 6 · 7

⊕ PH1 · 2 · 3

⊛ PZ1 · 2 · 3

⊛ T 10 · 15 · 20 · 25 · 30

⊙ H 2 · 3 · 4 · 5 · 6

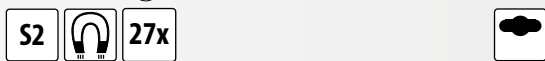

R.s. leírás 6
18422 27 db



FESTA
INDUSTRY

VDE CSAVARHÚZÓ SZIGETELT LAPOS



Č.p.	specifikace		
18088	3 x 75 mm	S2	12
18089	4 x 100 mm	CrV	12
18090	5,5 x 125 mm	CrV	12
18091	6,5 x 150 mm	CrV	12
18092	8 x 175 mm	CrV	12



FESTA
INDUSTRY

VDE CSAVARHÚZÓ SZIGETELT PHILIPS



Č.p.	specifikace		
18080	PH 0 x 60 mm	S2	12
18081	PH 1 x 80 mm	CrV	12
18082	PH 2 x 100 mm	CrV	12
18083	PH 3 x 150 mm	CrV	12



FESTA
INDUSTRY

VDE CSAVARHÚZÓ SZIGETELT POZIDRIVE



Č.p.	specifikace		
18084	PZ 0 x 60 mm	S2	12
18085	PZ 1 x 80 mm	CrV	12
18086	PZ 2 x 100 mm	CrV	12
18087	PZ 3 x 150 mm	CrV	12



FESTA

CSAVARHÚZÓ ÜTHETŐ LAPOS



Č.p.	specifikace		
18062	5,5 x 100 mm		12
18063	7 x 125 mm		6
18064	8 x 150 mm		8
18065	10 x 175 mm		6
18066	10 x 200 mm		6
18067	10 x 250 mm		6



FESTA

CSAVARHÚZÓ ÜTHETŐ PHILIPS



Č.p.	specifikace		
18070	PH 1 x 80 mm		8
18071	PH 2 x 100 mm		12
18072	PH 3 x 150 mm		6



FESTA

CSAVARHÚZÓ ÜTHETŐ POZIDRIVE



Č.p.	specifikace		
18075	PZ 1 x 80 mm		12
18076	PZ 2 x 100 mm		12
18077	PZ 3 x 150 mm		6



FESTA

CSAVARHÚZÓ ÜTHETŐ

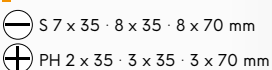

Č.p.	specifikace		
18411			1



Č.p.	specifikace		
18423			10



FESTA

CSAVARHÚZÓ KÉSZLET BITEKSEL

- ⊖ S 3x75 · 4x75 · 6x100 · 8x150 mm
- ⊕ PH 1x75 · 2x100 mm
- adapter 1/4"

- bits:
- ⊖ S 4 · 5 · 6 · 7 mm
 - ⊕ PH 1 · 2 · 3
 - ✱ PZ 1 · 2 · 3
 - ⊛ T 10 · 15 · 20
 - ↔ ◼ adapter



R.sz.	leírás
18418	



10



FESTA

CSAVARHÚZÓ KÉSZLET

- ⊖ S 3x60 · 4x75 · 6x100 · 6x125 mm
- ⊕ PH 0x60 · 1x75 · 2x100 mm



R.sz.	leírás
18400	



10



FESTA

CSAVARHÚZÓ KÉSZLET

- ⊖ S 3x60 · 6x100 · 6x125 mm
- ⊕ PH 1x75 · 2x100 mm



R.sz.	leírás
18401	



1

FESTA

CSAVARHÚZÓ LAPOS



R.sz.	leírás	
18101	3 x 75 mm	10
18102	4 x 100 mm	10
18103	5,5 x 100 mm	10
18104	5,5 x 125 mm	10
18105	6,5 x 100 mm	10
18106	6,5 x 125 mm	10
18107	8 x 160 mm	10
18108	10 x 160 mm	10



FESTA

CSAVARHÚZÓ PHILIPS



R.sz.	leírás	
18201	0 x 75 mm	10
18202	1 x 75 mm	10
18203	2 x 100 mm	10
18204	3 x 150 mm	10



FESTA

CSAVARHÚZÓ POZIDRIVE



R.sz.	leírás	
18301	0 x 75 mm	10
18302	1 x 75 mm	10
18303	2 x 100 mm	10
18304	3 x 150 mm	10



FESTA

MÁGNESES BITCSAVARHÚZÓ

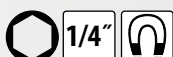

R.sz.	leírás	
18110		12

FESTA

CSAVARBEHÚZÓ CSAVARHÚZÓ

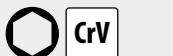

R.sz.	leírás	
18455	6 mm	12
18456	7 mm	12
18460	13 mm	12

FESTA

FLEXI CSAVARHÚZÓ BITHEZ

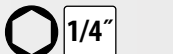

R.sz.	leírás	
18451		12

FESTA

FLEXI CSAVARHÚZÓ TÖMLŐBILINCSHEZ

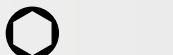

R.sz.	leírás	
18450	7 mm	6



RACSNIS
CSAVARHÚZÓ

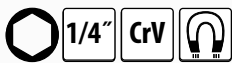

R.sz. 18433

leírás

6



MÁGNESES T
BITCSAVARHÚZÓ

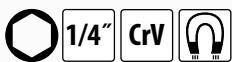

R.sz. 18608

leírás

6



T CSAVARHÚZÓ KLT.
+ 20 BIT

- ⊖ S 3 · 4 · 5 · 6 · 8 mm
- ⊕ PH 0 · 1 · 2 · 3
- adapter + 5 · 6 · 7 · 8 · 9 · 10 · 11 · 12 · 13 mm



R.sz. 18420

leírás

5



FINOM BITEK ADAPTEREKKEL

- ⊖ S 1.5 · 2 · 2.5 · 3 · 3.5 mm
- ⊕ PH 000 · 00 · 0 · 1
- ⊛ PZ 0 · 1
- ⊛ T 5 · 6 · 7 · 8 · 9 · 10 · 15 · 20
- ⊛ H 0.9 · 1.3 · 2.0 · 2.5 · 3.0 · 4.0

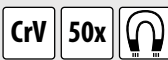

R.sz. 18431

leírás

6



CSAVARHÚZÓ + BIT

- 1/4" ⊖ ↔ ⊕ 1/4"
- ⊖ S 3 · 4 · 5 · 6 · 7 · 5 L
 - ⊕ PH 1 · 2 · 3 · 1L · 2 L
 - ⊛ PZ 1 · 2 · 3 · 1L · 2 L
 - ⊛ H 2 · 2.5 · 3 · 4 · 5 · 6
 - ⊛ T 10 · 15 · 20 · 25 · 27 · 30
 - ⊛ SQ 0 · 1 · 2 · 3
 - 1/4" 5 · 6 · 7 · 8 · 9 · 10 · 11 · 12 · 13 mm



R.sz. 18419

leírás

6



MŰSZERÉSZ CSAVARHÚZÓK

- ⊖ S 1,5x50 · 2x50 · 2,5x50 mm
- ⊕ PH 000x50 · 00x50 · 0x50 mm



R.sz. 18416

leírás

6



MŰSZERÉSZ CSAVARHÚZÓK
TORX

- ⊛ T 4 · 5 · 6 · 7 · 8 · 9 · 10x50 mm



R.sz. 18417

leírás

6



MŰSZERÉSZ CSAVARHÚZÓK

- ⊖ S 2,4 · 3,0 mm
- ⊕ PH 0 · 1
- ⊛ T 6 · 8



R.sz. 18415

leírás

10

FESTA



NEW



FESTA

FÁZISKERESŐ

· AC - 110 V, 250 V



R.s. Leírás

18427

24

FÁZISKERESŐ

DIN VDE 0680
73/23 EEC



R.s. leírás

18426 0 - 250 V

1



FESTA

SÖRNYITÓ

R.s. leírás

18437



5

ÓRÁS CSAVARHÚZÓ KLT.

⊖ S 1,4 · 2,0 · 2,4 · 3,0 mm

⊕ PH 0 · 1

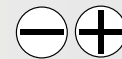

6x HOBBY



R.s. leírás

18408

10



BIT ADAPTER 90°



R.s.

18910



25



RACSNI BITEKHEZ

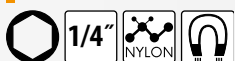

R.s.

18435

leírás
93 mm



1



ÓRÁS CSAVARHÚZÓ KLT.

⊖ S 1,0 · 1,2 · 1,4 · 1,8 · 2,4 · 3,0 mm

⊕ PH 00 · 0 · 1

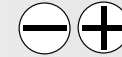

11x HOBBY



R.s. leírás

18409

48





TORZIÓS BIT PH - 50 MM



R.sz.	leírás	
18715	PH1 x 50 mm	1
18716	PH2 x 50 mm	1
18717	PH3 x 50 mm	1



TORZIÓS BIT PZ - 50 MM



R.sz.	leírás	
18710	PZ1 x 50 mm	1
18711	PZ2 x 50 mm	1
18712	PZ3 x 50 mm	1



TORZIÓS BIT T - 50 MM

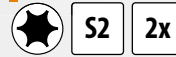

R.sz.	leírás	
18720	T10 x 50 mm	1
18721	T15 x 50 mm	1
18722	T20 x 50 mm	1
18723	T25 x 50 mm	1
18724	T30 x 50 mm	1
18725	T40 x 50 mm	1



TORZIÓS BIT KÉSZLET

- ⊕ PH 2 · 2
- ⊕ PZ 2
- ⊕ T 15 · 15 · 20 · 20 · 25 · 30 · 40

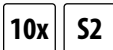

R.sz.	leírás	
18432		1



NEW



Bitek - profzionális csavarhúzó toldatok a legjobb minőségű CrV S2 anyagból

Gyártás technológiája

Kereszt és lapos csavarhúzó toldatok speciális technológiával vannak gyártva pontos kovácsolással. Amely lehetővé teszi a forma magas pontosságát és egyúttal magasabb szilárdságot is a bit megmunkálásával szemben 20%-kal. A bitek kovácsolása után az optimális keménység és szívósság elérésére edzve vannak. Rozsdamentesség elérése érdekében. További homok fúvással vannak kezelve

TiN réteg

Kétszeres felvitele a csavarhúzóhegyére maximálisan emeli a felület keménységét, ütésállóságát és. A surlódási tulajdonságot, mely meggátolja a befogásból való kicsúszást. TiN réteg korrózióálló is.

Gyémántszemcsék

A hegy felületén szőrszerűen „beleharapnak” a csap vagy csavar fejébe és megtartja a bitet a maximális becsavarási pillanatig. A legjobb biztosítékok a befogásban maradáshoz. A csavaros bitek leggyakrabban a befogásból történő kicsúszáskor sérülnek meg. A csavaró pillanat most átvivődik a minimális felületre, amelyik deformálódik.

Csúszásgátló vágások

A csavarhegyek kovácsolással készült munkafelületén további nagyon hatásos védelem a befogásból történő kicsúszás ellen.

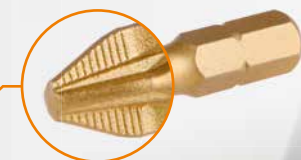



BIT PH



R.sz.	leírás	
18632A	PH2 x 25 mm	1
18633A	PH3 x 25 mm	1



BIT PZ

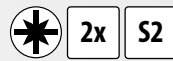

R.sz.	leírás	
18636A	PZ1 x 25 mm	1
18637A	PZ2 x 25 mm	1
18638A	PZ3 x 25 mm	1



BIT T

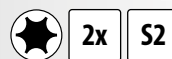

R.sz.	leírás	
18827A	T20 x 25 mm	1
18828A	T25 x 25 mm	1
18830A	T30 x 25 mm	1
18831A	T40 x 25 mm	1



BIT PH GYÉMÁNTOK



R.sz.	leírás	
18770	PH1 x 25 mm	5
18771	PH2 x 25 mm	5
18772	PH3 x 25 mm	5



BIT PZ GYÉMÁNTOK



R.sz.	leírás	
18775	PZ1 x 25 mm	5
18776	PZ2 x 25 mm	5
18777	PZ3 x 25 mm	5



BIT S



R.sz.	leírás	
18620	S 3 x 25 mm	5
18621	S 4 x 25 mm	5
18623	S 5 x 25 mm	5
18625	S 6 x 25 mm	5
18627	S 7 x 25 mm	5
18628	S 8 x 25 mm	5



BIT PH

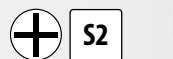

R.sz.	leírás	
18630	PH0 x 25 mm	5
18631	PH1 x 25 mm	5
18632	PH2 x 25 mm	5
18633	PH3 x 25 mm	5
18634	PH4 x 25 mm	5



BIT PZ

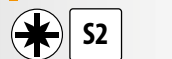

R.sz.	leírás	
18635	PZ0 x 25 mm	5
18636	PZ1 x 25 mm	5
18637	PZ2 x 25 mm	5
18638	PZ3 x 25 mm	5
18639	PZ4 x 25 mm	5



BIT PH

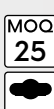

R.sz.	leírás	
18685	PH2 x 25 mm	25



BIT PZ



R.sz.	leírás	
18680	PZ2 x 25 mm	25



BIT PH



R.sz.	leírás	
18640	PH1 x 70 mm	10
18641	PH2 x 70 mm	10



BIT PZ



R.sz.	leírás	
18645	PZ1 x 70 mm	10
18646	PZ2 x 70 mm	10



BIT PH

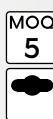
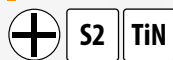

R.sz.	leírás	
18760	PH0 x 25 mm	5
18761	PH1 x 25 mm	5
18762	PH2 x 25 mm	5
18763	PH3 x 25 mm	5
18764	PH4 x 25 mm	1



BIT PZ

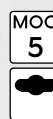
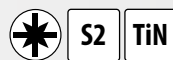

R.sz.	leírás	
18765	PZ0 x 25 mm	5
18766	PZ1 x 25 mm	5
18767	PZ2 x 25 mm	5
18768	PZ3 x 25 mm	5
18769	PZ4 x 25 mm	5



BIT S

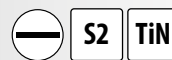

R.sz.	leírás	
18750	S 3 x 25 mm	5
18751	S 4 x 25 mm	5
18753	S 5 x 25 mm	5
18755	S 6 x 25 mm	5



BIT H



R.sz.	leírás	
18800	H 1,5 x 25 mm	5
18801	H 2,0 x 25 mm	5
18802	H 2,5 x 25 mm	5
18803	H 3,0 x 25 mm	5
18804	H 4,0 x 25 mm	5
18805	H 5,0 x 25 mm	5
18806	H 5,5 x 25 mm	5
18807	H 6,0 x 25 mm	5



BIT TTA



R.sz.	leírás	
18835	TTa 5 x 25 mm	10
18836	TTa 6 x 25 mm	5
18837	TTa 7 x 25 mm	5
18838	TTa 8 x 25 mm	5
18839	TTa 9 x 25 mm	5
18840	TTa 10 x 25 mm	5
18841	TTa 15 x 25 mm	5
18842	TTa 20 x 25 mm	5
18843	TTa 25 x 25 mm	5
18844	TTa 27 x 25 mm	5
18845	TTa 30 x 25 mm	5
18846	TTa 40 x 25 mm	5
18847	TTa 45 x 25 mm	5



BIT T



R.sz.	leírás	
18820	T5 x 25 mm	5
18821	T6 x 25 mm	5
18822	T7 x 25 mm	5
18823	T8 x 25 mm	5
18824	T9 x 25 mm	5
18825	T10 x 25 mm	5
18826	T15 x 25 mm	5
18827	T20 x 25 mm	5
18828	T25 x 25 mm	5
18829	T27 x 25 mm	5
18830	T30 x 25 mm	5
18831	T40 x 25 mm	5
18832	T45 x 25 mm	5



BIT HTA



R.sz.	leírás	
18810	HTa 1,5 x 25 mm	5
18811	HTa 2,0 x 25 mm	5
18812	HTa 2,5 x 25 mm	5
18813	HTa 3,0 x 25 mm	5
18814	HTa 4,0 x 25 mm	5
18815	HTa 5,0 x 25 mm	5
18816	HTa 5,5 x 25 mm	5
18817	HTa 6,0 x 25 mm	5



BIT SQ



R.sz.	leírás	
18850	SQ 0 x 25 mm	5
18851	SQ 1 x 25 mm	5
18852	SQ 2 x 25 mm	5
18853	SQ 3 x 25 mm	5



BIT T



Č.p.	specifikace	
17980	T30 x 35 mm	3
17981	T40 x 35 mm	3
17982	T45 x 35 mm	3
17983	T50 x 35 mm	3



BIT SD



R.sz.	leírás	
18855	SD 6 x 25 mm	5
18856	SD 8 x 25 mm	5



BIT T



R.sz.	leírás	
17970	T20 x 75 mm	3
17971	T25 x 75 mm	3
17972	T30 x 75 mm	3
17973	T40 x 75 mm	3

R.sz.	leírás	
17974	T45 x 75 mm	3
17975	T50 x 75 mm	3
17976	T55 x 75 mm	3



BIT TS



R.sz.	leírás	
18864	TS 4 x 25 mm	5
18865	TS 6 x 25 mm	5



BIT 5/32', 3/16'



R.sz.	leírás	
18866	5/32 x 25 mm	5
18867	3/16 x 25 mm	5



BIT TW



R.sz.	leírás	
18860	TW 1 x 25 mm	5
18861	TW 2 x 25 mm	5
18862	TW 3 x 25 mm	5
18863	TW 4 x 25 mm	5



BIT XZN



R.sz.	leírás	
18870	M4 x 25 mm	5
18871	M5 x 25 mm	5
18872	M6 x 25 mm	5
18873	M8 x 25 mm	5
18874	M10 x 25 mm	5



BIT ADAPTER

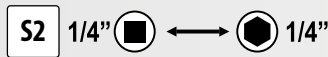

R.sz.	leírás	
18868	25 mm	5



BIT ADAPTER

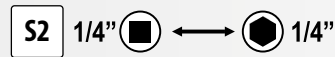

R.sz.	leírás	
18869	50 mm	5



FESTA
INDUSTRY

GIPSZKARTON BIT



R.s. leírás
18795 PH 2 x 25 mm 24



FESTA
INDUSTRY

GIPSZKARTON BIT



R.s. leírás
18796 PH 2 x 55 mm 24



FESTA
INDUSTRY

ADAPTER
RACSNI 1/4' - BIT

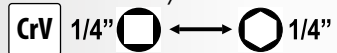

R.s. leírás
18619 5



FESTA
INDUSTRY

BIT BEFOGÓ,
MÁGNESES



R.s. leírás
18600 1/4' x 60 mm 5



FESTA
INDUSTRY

BIT BEFOGÓ,
MÁGNESES



R.s. leírás
18601 1/4' x 60 mm 5



FESTA
INDUSTRY

BIT BEFOGÓ,
MÁGNESES

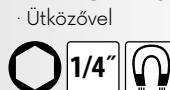

R.s. leírás
18602 1/4' x 60 mm 5



FESTA
INDUSTRY

BIT BEFOGÓ,
MÁGNESES



R.s. leírás
18797 1/4' x 60 mm 1



FESTA
INDUSTRY

BIT BEFOGÓ,
MÁGNESES



R.s. leírás
18798 1/4' x 60 mm 1



FESTA
INDUSTRY

BIT BEFOGÓ,
MÁGNESES

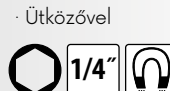

R.s. leírás
18799 1/4' x 60 mm 1



FESTA
INDUSTRY

BIT BEFOGÓ,
MÁGNESES



R.s. leírás
18605 150 mm 1



FESTA
INDUSTRY

ADAPTER SDS + BIT 1/4"



R.s. leírás
20743 75 mm 1



BIT BEFOGÓ,
MÁGNESES

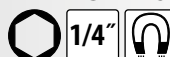

R.s. leírás
18607 80 mm 25



FESTA

BIT BEFOGÓ,
MÁGNESES



R.s. 18609 Leírás 90mm



1

**WEST
BERG**

ADAPTER
BIT 1/4" - SDS +

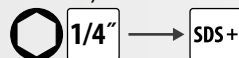

R.s. 20742 Leírás



1



**FESTA
INDUSTRY**

BIT ÉS ADAPTER
KÍNÁLÓ KLT.

- 10x ⊕ 18630 PH0
- 10x ⊕ 18631 PH1
- 10x ⊕ 18632 PH2
- 10x ⊕ 18633 PH3
- 10x ⊕ 18635 PZ0
- 10x ⊕ 18636 PZ1
- 10x ⊕ 18637 PZ2
- 10x ⊕ 18638 PZ3
- 10x ⊕ 18761 PH1 TiN
- 10x ⊕ 18762 PH2 TiN
- 10x ⊕ 18763 PH3 TiN
- 10x ⊕ 18766 PZ1 TiN
- 10x ⊕ 18767 PZ2 TiN
- 10x ⊕ 18768 PZ3 TiN
- 10x ⊕ 18770 PH1 DIAMANT
- 10x ⊕ 18771 PH2 DIAMANT
- 10x ⊕ 18775 PZ1 DIAMANT
- 10x ⊕ 18776 PZ2 DIAMANT
- 10x ⊙ 18814 4,0HTa
- 10x ⊙ 18815 5,0HTa
- 10x ⊕ 18842 20TTa
- 10x ⊕ 18845 30TTa
- 10x ⊕ 18795 PH2 Gipszkarton bit
- 5x 18612 ADAPTER 1/4" 8mm
- 5x 18613 ADAPTER 1/4" 10mm
- 5x 18600 Bit befogó, mágneses 1/4" 60mm
- 5x 18601 Bit befogó, mágneses 1/4" 60mm
- 5x 18602 Bit befogó, mágneses 1/4" 65mm

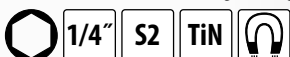

R.s. 18993 Leírás

1

**FESTA
INDUSTRY**

BIT KÍNÁLÓ KLT.

- 10x ⊕ 18631 PH1
- 10x ⊕ 18632 PH2
- 10x ⊕ 18633 PH3
- 10x ⊕ 18636 PZ1
- 10x ⊕ 18637 PZ2
- 10x ⊕ 18638 PZ3
- 10x ⊕ 18761 PH1 TiN
- 10x ⊕ 18762 PH2 TiN
- 10x ⊕ 18763 PH3 TiN
- 10x ⊕ 18766 PZ1 TiN
- 10x ⊕ 18767 PZ2 TiN
- 10x ⊕ 18768 PZ3 TiN
- 10x ⊙ 18804 H 4
- 10x ⊙ 18805 H 5
- 10x ⊙ 18825 T 10
- 10x ⊙ 18826 T 15
- 10x ⊙ 18827 T 20
- 10x ⊙ 18828 T 25
- 10x ⊙ 18830 T 30
- 10x ⊙ 18831 T 40

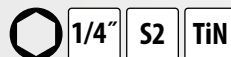

R.s. 18994 Leírás

1

**FESTA
INDUSTRY**

ADAPTER 1/4"

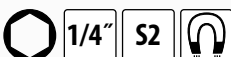

MOQ
5



R.s.	leírás	
18610	6 mm	5
18611	7 mm	5
18612	8 mm	5

R.s.	leírás	
18613	10 mm	5
18614	12 mm	5
18615	13 mm	5

**FESTA
INDUSTRY**

ADAPTER 1/4"



R.s.	leírás	
18610A	6 mm	5
18611A	7 mm	5
18612A	8 mm	5

R.s.	leírás	
18613A	10 mm	5
18614A	12 mm	5
18615A	13 mm	5

FESTA

CSAVARBEHAJTÓ KLT. MÁGNESES

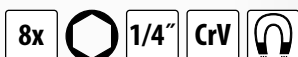

R.s. 18618 Leírás 6, 7, 8, 9, 10, 11, 12, 13 mm



12





FESTA

BIT KLT.

- bit 25 mm
- ⊖ S 3 · 4 · 5 · 6
 - ⊕ PH 0 · 1 · 2 · 3
 - ⊛ PZ 0 · 1 · 2 · 3
 - H 3 · 4 · 5 · 6
 - ⊛ T 10 · 15 · 20 · 25 · 27 · 30 · 40
 - ⊛ TTa 10 · 15 · 20 · 25 · 27 · 30 · 40

toldalék bitekre

32x CrV



R.s. leírás
18908 1



FESTA

BIT KLT.

- ⊕ S 3 · 4 · 5 · 6
 - PH 1 · 2 · 3
 - ⊖ PZ 1 · 2 · 3
 - H 3 · 4 · 5 · 6
 - ⊛ T 10 · 15 · 20 · 25 · 27 · 30 · 40
 - ⊛ TTa 10 · 15 · 20 · 25 · 27 · 30 · 40
- Bit befogó behajtóhoz, mágneses

33x 1/4" S2

R.s. leírás
18905 10



FESTA

BIT KLT.

- ⊕ S 4 · 5 · 6
 - ⊖ PH 1 · 2 · 3
 - ⊛ PZ 1 · 2 · 3
 - ⊛ H 3 · 4 · 5 · 6
 - ⊛ T 10 · 15 · 20 · 25 · 27 · 30 · 40
 - TTa 10 · 15 · 20 · 25 · 27 · 30 · 40
- Bit befogó behajtóhoz, mágneses

57x 1/4" S2

R.s. leírás
18906 6

FESTA

BIT KLT.

- ⊛ HTa 2 · 2.5 · 3 · 4 · 5 · 6
5/32" · 9/64" · 1/8"
7/64" · 3/32" · 5/64"
 - ⊖ SD 4 · 6 · 8 · 10
 - ⊛ TS 6 · 8 · 10
 - ⊛ TW 1 · 2 · 3 · 4
 - ⊛ TTa 8 · 10 · 15 · 20 · 25 · 27 · 30 · 35 · 40
- Mágneses todalék bitekre

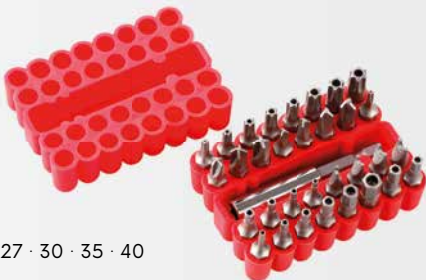

33x 1/4" S2

R.s. leírás
18900 10

FESTA

BIT KLT.

- ⊖ S 3 · 4 · 4.5 · 5 · 5.5 · 6 · 6.5 · 7 · 8
- ⊕ PH 0 · 1 · 2 · 3
- ⊛ PZ 0 · 1 · 2 · 3
- ⊖ Q 0 · 1 · 2 · 3
- ⊛ 8 · 10 · 15 · 20 · 25 · 27 · 30 · 40 · 45
- ⊛ TTa 8 · 10 · 15 · 20 · 25 · 27 · 30 · 35 · 40
- H 1.5 · 2 · 2.5 · 3 · 4 · 5 · 5.5 · 6 · 8 mm
1/16" · 5/64" · 3/32" · 7/64" · 1/8" · 9/64"
5/32" · 3/16" · 7/32" · 1/4"
- ⊛ HTa 2 · 2.5 · 3 · 4 · 5 · 6 mm
5/64" · 3/32" · 7/64" · 1/8" · 9/64" · 5/32"
- ⊖ SD 4 · 6 · 8 · 10
- ⊛ TS 6 · 8 · 10
- ⊛ TW 1 · 2 · 3 · 4
- ⊛ 2-wing 1 · 2 · 3
- ⊛ ZN 5 · 6 · 8



Mágneses todalék bitekre
Todalék bitekre
1/4" DR Csavarhúzó todalék – hosszabbító
1/4" bit adapter: 25mm, 50mm

100x 1/4" S2

R.s. leírás
18909 24

FESTA

BIT KLT.

- ⊖ S 3 · 4 · 5 · 6 · 7
 - ⊛ PH 0 · 1 · 2 · 3
 - PZ 1 · 2 · 3
 - ⊕ H 2 · 2.5 · 3 · 4 · 5 · 6
 - ⊛ T 10 · 15 · 20 · 25 · 30 · 40
- Mágneses todalék bitekre



33x 1/4" S2

R.s. leírás
18901 10

BIT KLT.

- ⊖ S 4 · 5 · 6 · 7
- ⊕ PH 1 · 2 · 3
- ✱ PZ 1 · 2 · 3
- H 4 · 5 · 6
- ⊛ T 10 · 15 · 20 · 25
- SQ 1 · 2 · 3

20x S2



BIT KLT.

- ⊖ S 4 · 5 · 6 · 7
- ⊕ PH 1 · 2 · 3
- ✱ PZ 1 · 2 · 3

10x CrV TiN



BIT KLT.

- ⊖ S 3 · 5 · 7
- ⊕ PH 1 · 2 · 3

Mágneses toldalék bitekre

7x HOBBY



R.s. leírás 10 18907

R.s. leírás 10 18440

R.s. leírás 20 18430



BIT KLT.

- ⊕ S 3 · 3,5 · 4 · 5,5
- ✱ PH 0 · 1 · 2 · 3
- ⊖ PZ 0 · 1 · 2 · 3
- H 3 · 4
- ⊛ T 10 · 15 · 20 · 25 · 27 · 30
- 1/4" 4 · 4,5 · 5 · 5,5 · 6 · 7 · 8 · 9 · 10 · 11 · 13

Csavarhúzó toldalék – hosszabbító
Mágneses toldalék bitekre

CrV 1/4"

40x



R.s. leírás 10 18915

SZERSZÁM KLT.

- ⊖ S 5 · 6 mm
- ⊕ PH 1 · 2
- H 3 · 4 · 5 · 6
- ⊛ T 15 · 20 · 25 · 30
- 1/4" 4 · 5 · 6 · 7 · 8 · 9 · 10 · 12 · 13 mm

75 mm 1/4"
 1/4" ↔ 1/4"

1/4" CrV

23x



R.s. leírás 10 18421



FESTA

SZERSZÁM KLT.

122x CrV S2 1/4" 1/2" 72T

- 1/2", 1/4"
- 1/4" · 4-5-6-7-8-9mm
- 1/2" · 10-12-13-14-17-19mm
- 1/4" · 4-4.5-5-5.5-6-7-8-9-10-11-12-13-14mm
- 1/2" · 12-13-14-15-16-17-18-19-20-21-22-24mm
- 1/2", 1/4"
- 1/4" 1/4"
- 1/4" · 150mm
- 1/2" · 254mm
- 1/2", 1/4"
- 1/2" · 16-21mm
- 1/4" · 150mm
- 1/2" · E10-E12-E14-E16-E18-E20-E22-E24
- 1/4" S 3 · 4 · 5 · 6
- 1/4" PH 0 · 1 · 2
- 1/4" PZ 0 · 1 · 2
- 1/4"
- 1/4" · S 4 · 5,5 · 6,5
- 1/4" PH 1 · 2 · 3
- 1/4" PZ 2 · 3
- 1/4" H 3 · 4 · 5 · 6
- 1/4" T 8 · 10 · 15 · 20 · 25
- 1/4" TTa 10 · 15 · 20 · 25 · 40
- 2 · 2,5 · 3 · 4 · 5 · 6 · 7 · 8 · 10mm
- 8-9-10-11-12-13-14-15-16-17-18-19mm
- S 4x100 · 6,5x150
- PH 2x100 · 3x150
- 180mm
- 160mm
- 160mm
- 250mm
- 300g



R.s. leírás
17238 122 db

1



SZERSZÁM KLT.

- 160 mm
- 160 mm
- 300 g
- 1/4" 45T
- 4 · 5 · 6 · 7 · 8 · 9 · 10 · 11 · 12 · 13 mm
- 1/4" 75 mm
- 1,5 · 2 · 2,5 · 3 · 4 · 5 · 6 · 8 · 10 mm
- S 3 · 4 · 5 · 6 mm
- PH 0 · 1 · 2 · 3
- PZ 0 · 1 · 2 · 3
- T 10 · 15 · 20 · 25
- H 3 · 4 · 5 · 6
- S 5x100 mm
- PH 1x100 · 2x100 mm
- S 2,5x50 mm
- PH 00x50 · 0x50 mm
- AC 100-250 V
- 200 mm max. 22 mm
- 10x11 · 12x13 · 14x15 · 16x17 mm
- 18 mm
- 2 m 13 mm

60x



35x

R.s. leírás
17259

5



SZERSZÁM KLT.

- 120mm
- 125mm
- 115mm
- 150mm max. 19mm
- 9mm
- 1/4"
- S 4 · 6 mm
- PH 1 · 2 · 3
- PZ 1 · 2
- H 4 · 5 · 6
- 1/4" 160mm
- 5 · 6 · 7 · 8 · 9 · 10 · 11 mm
- 1/4"
- 1/4"



SZERSZÁM KLT.

- 1/4" 5 · 6 · 7 · 8 · 9 · 10 · 11 · 12 mm
- 1/4"
- 1/4"
- AC 230 V
- PH 0, SL 3
- 9x 1,5-10 mm
- 160 mm
- S 3 · 4 · 5 · 6 mm
- PH 0 · 1 · 2 · 3
- H 4 · 5
- PH 2x100, S 6x100
- 18 mm
- 1 m
- 300 g

39x



R.s. leírás
17247

10

FESTA

10 years
guarantee



Cr-Mo

- Felhasználás iparban és szervizben
- Kiváló minőségű króm vanádium-acél
- racsnis villás kulcs 72 polírozott foggal a legfontosabb munkához
- Minden alkatrész megfelel a DIN-szabványoknak
- Horganyzott fej a tökéletes fogáshoz
- Tartós hordtáska fém zárral és zsanérokkal



FESTA

DUGÓKULCS KLT.

- 1/2", 1/4", 3/8"
- 1/4" · 4-5-6-7-8-9-10mm
- 3/8" · 10-11-12-13-14-15mm
- 1/2" · 16-17-18-19-22mm
- 1/4" · 4-4.5-5-5.5-6-7-8-9-10-11-12-13-14mm
- 3/8" · 10-11-12-13-14-15-16-17-18-19mm
- 1/2" · 10-11-12-13-14-15-16-17-18-19-20-21-22-24-27-30-32mm
- 1/4" · E4-E5-E6-E7-E8
- 3/8" · E10-E11-E12-E14-E16-E18
- 1/2" · E20-E24
- 1/2" · 24x
- 1/4" · 20x
- 1/4" · 30x
- 1/4" · 50 mm, 100 mm
- 1/2" · 125 mm, 250 mm
- 3/8" · 150 mm
- 1/2" · 16-21mm
- 3/8" · 18mm
- 1/2", 1/4", 3/8" bit holder
- 1/2", 1/4", 3/8"
- 1/4" · 150mm
- 1/4" · 115mm
- Inbus 7X



10 years
guarantee



CrV S2 1/4" 1/2" 3/8" 72T 171x ERGO HANDLE

R.s. leírás
17237 2



FESTA

DUGÓKULCS KLT.

- 1/2" · 72T
- 1/2" · 125 mm
- 1/2" · 10-11-12-13-14-15-17-19-22-24 mm

10 years guarantee

CrV 1/2" 72T 12x ERGO HANDLE

Č.p. specifikace 17245 15



FESTA

DUGÓKULCS KLT.

- 1/2" · 72T
- 1/2" · 125 mm
- 1/2" · 10-11-12-13-14-15-17-19-22-24 mm

10 years guarantee

CrV 1/2" 72T 12x ERGO HANDLE

Č.p. specifikace 17229 8



FESTA

DUGÓKULCS KLT.

- 1/2" · 72 T
- 1/2" · 75, 125 mm
- 1/2"
- 1/2" · 10-11-12-13-14-15-16-17-18-19-22-24 mm
- 1/2" · 17mm, 19mm
- 3 way adapter
- 16mm, 21mm

10 years guarantee

CrV 1/2" 72T 20x ERGO HANDLE

Č.p. specifikace 17230 4



FESTA

DUGÓKULCS KLT.

- 1/4" · 72 T
- 1/4" · 50, 100 mm
- 1/4"
- 1/4" · 4-5-5,5-6-7-8-10-11-12-13 mm
- 1/4" · 6-7-8-10-12-13 mm
- 3 way adapter
- 4 x
- 11x
- 1x

10 years guarantee

CrV S2 1/4" 72T 36x ERGO HANDLE

Č.p. specifikace 17231 10



FESTA

DUGÓKULCS KLT.

- 1/4"
- 1/4"
- 1/4" · 4-4,5-5-5,5-6-7-8-9-10-11-12-13-14 mm
- 1/4" · 50 mm, 100 mm
- 1/4"
- 1/4"
- 21 x
- 1/4"
- L 1/4"

10 years guarantee

CrV S2 1/4" 72T 45x ERGO HANDLE

Č.p. specifikace 17233 10



FESTA

DUGÓKULCS KLT.

- 1/2", 1/4" · 72T
- 1/4"
- 16 mm, 21 mm
- 1/4" · 10-11-12-13-14-15-16-17-18-19-20-21-22-23-24-27 mm
- 1/4" · 100 mm
- 1/2" · 125 mm, 250 mm
- 1/4"
- 1 x
- 1/4" · 4-5-5,5-6-7-8-10-11-12-13 mm
- 33 x

10 years guarantee

CrV S2 1/4" 1/2" 72T 73x ERGO HANDLE

Č.p. specifikace 17234 4

FESTA

DUGÓKULCS KLT.

- 1/2", 1/4" · 72T
- 1/4"
- 16 mm, 21 mm
- 1/4" · 4 -4,5-5-5,5-6-7-8-9-10-11-12-13-14 mm
- 1/2" · 10-11-12-13-14-15-16-17-18-19-20-21-22-23-24-27-30-32 mm
- 1/4" · 6-7-8-9-10-11-12-13 mm
- 1/2" · 14-15-17-19 mm
- 1/4" · 50 mm, 100 mm
- 1/2" · 125 mm, 250 mm
- 1/4"
- 5/16" bit holder
- 7x
- 15x
- 3 way adapter
- 3 x
- 1/4"
- L 1/4"
- 1/2", 1/4"

CrV S2 1/4" 1/2" 72T 94x ERGO HANDLE



10 years guarantee

Č.p.	specifikace
17235	4

FESTA

DUGÓKULCS KLT.

- 1/2", 1/4" · 72T
- 150 mm
- 16 mm, 21 mm
- 1/4" · 4 -4,5-5-5,5-6-7-8-9-10-11-12-13-14 mm
- 1/2" · 10-11-12-13-14-15-16-17-18-19-20-21-22-24-27-30-32 mm
- 1/4" · 6-7-8-9-10-11-12-13 mm
- 1/2" · 14-15-17-19-22 mm
- 1/4" · 50 mm, 100 mm
- 1/2" · 125 mm, 250 mm
- E · 4-5-6-7-8-10-11-12-14-16-18-20-24-27-30-32 mm
- 1/2", 1/4"
- 5/16" bit holder
- 18 x
- 17 x
- 3 way adapter
- 4 x
- 1/4"
- L 1/4"

CrV S2 1/4" 1/2" 72T 110x ERGO HANDLE



10 years guarantee

Č.p.	specifikace
17236	4

FESTA

SZERSZÁM KLT.

- 1/2", 1/4"
- 1/4" · 4-5-6-7-8-9mm
- 1/2" · 10-12-13-14-17-19mm
- 1/4" · 4-4,5-5-5,5-6-7-8-9-10-11-12-13-14mm
- 1/2" · 12-13-14-15-16-17-18-19-20-21-22-24mm
- 1/2", 1/4"
- 1/4"/4" → 1/4"/4"
- 1/4" · 150mm
- 1/2" · 254mm
- 1/2", 1/4"
- 1/2" · 16-21mm
- 1/4" · 150mm
- 1/2" · E10-E12-E14-E16-E18-E20-E22-E24
- 1/4" · S 3 · 4 · 5 · 6
- 1/4" · PH 0 · 1 · 2
- 1/4" · PZ 0 · 1 · 2
- 1/4" · S 4 · 5,5 · 6,5
- 1/4" · PH 1 · 2 · 3
- 1/4" · PZ 2 · 3
- 1/4" · H 3 · 4 · 5 · 6
- 1/4" · T 8 · 10 · 15 · 20 · 25
- 1/4" · TTα 10 · 15 · 20 · 25 · 40
- 2 · 2,5 · 3 · 4 · 5 · 6 · 7 · 8 · 10mm
- 8-9-10-11-12-13-14-15-16-17-18-19mm
- S 4x100 · 6,5x150
- PH 2x100 · 3x150
- 180mm
- 160mm
- 160mm
- 250mm
- 300g

CrV S2 1/4" 1/2" 72T 122x ERGO HANDLE



Č.p.	specifikace
17238	122 ks 1



FESTA



FESTA**FESTA RACSNIS HAJTÓSZÁR**

- a hajtószár a legjobb minőségű crv acélnól készül
- a 72 fogú racsni a precízebb munkát segíti elő
- minőségi ergonómikus két komponenses szoft gumi nyél
- gyors kioldó rendszer a dugófejek gyors és egyszerű cseréjéhez

**FESTA**

RACSNIS



Č.p.	specifikace	délka	
17297	1/4"	155 mm	6
17298	3/8"	210 mm	5
17299	1/2"	255 mm	4

FESTA

RACSNIS



Č.p.	specifikace	délka	
17240	1/4"	155 mm	10
17241	3/8"	200 mm	10
17242	1/2"	250 mm	5

FESTA

RACSNIS



Č.p.	specifikace	délka	
17294	1/4"	155 mm	6
17295	3/8"	205 mm	10
17296	1/2"	255 mm	4

FESTA

RACSNIS 1/4"



Č.p.	specifikace	
17292	1/4"	1

RACSNIS

HOBBY

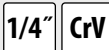

Č.p.	specifikace	
17243	1/4" 43T	25
17244	1/2" 39T	25

FESTAADAPTER
DUGÓKULCSOKHOZ

Č.p.	specifikace	
18603	1/4" 150 mm	10

**FESTA**DUGÓKULCS
FEJ 1/4'

Č.p.	specifikace	
17820	4 mm • 25 mm	10
17821	4,5 mm • 25 mm	10
17822	5 mm • 25 mm	10
17823	5,5 mm • 25 mm	10
17824	6 mm • 25 mm	10
17825	7 mm • 25 mm	10
17826	8 mm • 25 mm	10
17827	9 mm • 25 mm	10
17828	10 mm • 25 mm	10
17829	11 mm • 25 mm	10
17830	12 mm • 25 mm	10
17831	13 mm • 25 mm	10
17832	14 mm • 25 mm	10

**FESTA**DUGÓKULCS
FEJ 1/2'

Č.p.	specifikace	
17308	8 mm • 38 mm	10
17309	9 mm • 38 mm	10
17310	10 mm • 38 mm	10
17311	11 mm • 38 mm	10
17312	12 mm • 38 mm	10
17313	13 mm • 38 mm	10
17314	14 mm • 38 mm	10
17315	15 mm • 38 mm	10
17316	16 mm • 38 mm	10
17317	17 mm • 38 mm	10
17318	18 mm • 38 mm	10
17319	19 mm • 38 mm	10
17320	20 mm • 38 mm	10
17321	21 mm • 38 mm	10
17322	22 mm • 38 mm	10
17324	24 mm • 38 mm	10
17327	27 mm • 42 mm	20
17330	30 mm • 42 mm	25
17332	32 mm • 42 mm	20
17333	34 mm • 42 mm	20
17334	36 mm • 42 mm	20

**FESTA**DUGÓKULCS
FEJ 3/4'

Č.p.	specifikace	
17835	17 mm • 48 mm	10
17836	18 mm • 48 mm	10
17837	19 mm • 48 mm	10
17838	21 mm • 48 mm	10
17839	22 mm • 48 mm	10
17840	24 mm • 48 mm	10
17841	26 mm • 48 mm	10
17842	27 mm • 52 mm	10
17843	28 mm • 52 mm	10
17844	30 mm • 52 mm	10
17845	32 mm • 52 mm	10
17846	33 mm • 55 mm	10
17847	36 mm • 60 mm	10
17848	38 mm • 60 mm	10
17849	41 mm • 65 mm	10
17850	46 mm • 65 mm	10
17851	50 mm • 70 mm	10
17852	55 mm • 75 mm	10
17853	60 mm • 78 mm	10
17854	65 mm • 82 mm	10
17855	70 mm • 82 mm	10
17856	75 mm • 88 mm	10

**FESTA**DUGÓKULCS
FEJ MULTILOCK 1/2'

Č.p.	specifikace	
17910	8 mm • 38 mm	10
17914	12 mm • 38 mm	10
17916	14 mm • 38 mm	10
17922	21 mm • 38 mm	10
17924	24 mm • 38 mm	10
17926	30 mm • 38 mm	10

**FESTA**DUGÓKULCS
FEJ 1/4'

Č.p.	specifikace	
17860	4 mm • 50 mm	10
17861	5 mm • 50 mm	10
17862	6 mm • 50 mm	10
17863	7 mm • 50 mm	10
17864	8 mm • 50 mm	10
17865	9 mm • 50 mm	10
17866	10 mm • 50 mm	10
17867	11 mm • 50 mm	10
17868	12 mm • 50 mm	10
17869	13 mm • 50 mm	10
17870	14 mm • 50 mm	10

**FESTA**DUGÓKULCS
FEJ 1/2'

Č.p.	specifikace	
17871	10 mm • 70 mm	10
17872	11 mm • 70 mm	10
17873	12 mm • 70 mm	10
17874	13 mm • 70 mm	10
17875	14 mm • 70 mm	10
17876	15 mm • 70 mm	10
17877	16 mm • 70 mm	10
17878	17 mm • 70 mm	10
17879	18 mm • 70 mm	10
17880	19 mm • 70 mm	10
17881	20 mm • 70 mm	10
17882	21 mm • 70 mm	10
17883	22 mm • 70 mm	10
17884	23 mm • 70 mm	10
17885	24 mm • 70 mm	10
17886	25 mm • 70 mm	10
17887	26 mm • 70 mm	10
17888	27 mm • 70 mm	10
17889	28 mm • 70 mm	10
17890	30 mm • 70 mm	10
17891	32 mm • 70 mm	10
17892	34 mm • 70 mm	10

**FESTA**DUGÓKULCS
FEJ TORX 1/2'

Č.p.	specifikace	
17943	E22	10
17944	E24	10

**FESTA**DUGÓKULCS
FEJ TORX 1/4'

Č.p.	specifikace	
17930	E4	10
17934	E8	10
17935	E10	10

**FESTA**DUGÓKULCS
FEJ MULTILOCK 1/4'

Č.p.	specifikace	
17895	4 mm • 25 mm	10
17896	4,5 mm • 25 mm	10
17897	5 mm • 25 mm	10
17898	5,5 mm • 25 mm	10
17904	11 mm • 25 mm	10
17905	12 mm • 25 mm	10
17907	14 mm • 25 mm	10

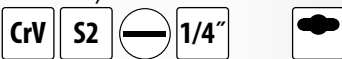

**FESTA**CSAVARHÚZÓ
FEJ 1/4"

Č.p.	specifikace	
18920	S 4 mm	10
18921	S 5,5 mm	10
18922	S 7 mm	10

**FESTA**CSAVARHÚZÓ
FEJ 1/4"

Č.p.	specifikace	
18925	PH 1	10
18926	PH 2	10
18927	PH 3	10

**FESTA**CSAVARHÚZÓ
FEJ 1/4"

Č.p.	specifikace	
18928	PZ 0	10
18929	PZ 1	10
18930	PZ 2	10
18931	PZ 3	10

**FESTA**CSAVARHÚZÓ
FEJ 1/2"

Č.p.	specifikace	
18954	T 10	10
18955	T 15	10
18956	T 20	10
18960	T 40	10
18961	T 45	10
18963	T 55	10

**FESTA**CSAVARHÚZÓ
FEJ 1/4"

Č.p.	specifikace	
18948	T 5	10
18950	T 8	10
18951	T 10	10

**FESTA**CSAVARHÚZÓ
FEJ 1/4"

Č.p.	specifikace	
18934	3 mm	10
18939	8 mm	10

**FESTA**CSAVARHÚZÓ
FEJ 1/2"

Č.p.	specifikace	
18971	M 16	10

**FESTA**

HAJTÓKAR ADAPTER

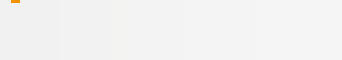

Č.p.	specifikace	
17420	1/4"	1
17421	1/2"	1
17422	3/4"	1

**FESTA**

ADAPTER

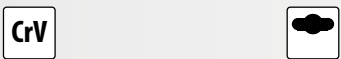

Č.p.	specifikace	
17410	A - 1/4" B - 3/8"	10
17411	A - 3/8" B - 1/4"	10
17412	A - 3/8" B - 1/2"	10
17413	A - 1/2" B - 3/8"	10
17414	A - 1/2" B - 3/4"	10
17415	A - 3/4" B - 1/2"	10
17416	A - 1/4" B - 1/2"	10

**FESTA**HOSSZABBÍTÓ
SZÁR

Č.p.	specifikace	
17390	1/4" • 50 mm	1
17391	1/4" • 100 mm	1
17392	1/4" • 150 mm	1
17393	1/2" • 75 mm	1
17394	1/2" • 125 mm	1
17395	1/2" • 250 mm	1
17396	3/4" • 100 mm	1
17397	3/4" • 200 mm	1
17398	3/4" • 400 mm	1

**FESTA**

KARDÁN CSUKLÓ

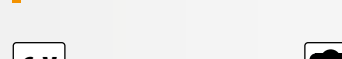

Č.p.	specifikace	
17405	1/4" • 39 mm	10
17406	1/2" • 71 mm	10
17407	3/4" • 105 mm	10

FESTA

„T” HAJTÓKAR



Č.p.	specifikace	
17382	1/4" • 115 mm	1
17383	3/8" • 190 mm	1
17384	1/2" • 250 mm	1
17385	3/4" • 460 mm	1
17386	1" • 640 mm	1

FESTA

T KULCS

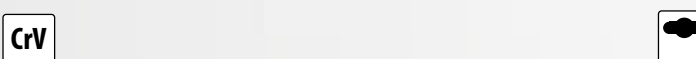

Č.p.	specifikace	
17401	1/4" • 250 mm	1
17402	1/2" • 400 mm	1



FESTA
HAJTÓKAR, CSUKLÓS

CrV				
R.s.	leírás			
17380	1/2" • 350 mm	1		
17381	3/4" • 500 mm	1		



FESTA
HAJTÓKAR 90°-OS

CrV	1/2"			
R.s.	leírás			
17427	1/2" • 60 x 320 mm	1		



FESTA
RUGÓS HOSSZABBÍTÓ

CrV	1/4"			
R.s.	leírás			
17400	1/4" • 150 mm	1		

Stahlberg
BIT ADAPTER
RACSNIRA 1/4"

CrV				
1/4"	↔	1/4"		
R.s.	leírás			
18619		5		



DUGÓKULCS FEJ
UNIVERZÁLIS

CrV	1/2"			
R.s.	leírás			
17812	10 - 19 mm	1		



DUGÓKULCS FEJ UNIVERZÁLIS

CrV	3/8"			
R.s.	leírás			
17810	7 - 19mm • 52mm x ø26mm	1		



DUGÓKULCS FEJ UNIVERZÁLIS

CrV	1/2"			
R.s.	leírás			
17811	11 - 32mm • 83mm x ø43mm	5		



DRIVELOCK DUGÓKULCS FEJ

CrV	1/4"	12x		
4-5-5,5-6-7-8-9-10-11-12-13 mm				
Č.p.	specifikace			
17250		10		



TORX DUGÓKULCS FEJ

CrV	1/2"	1/4"	9x	
1/4" • 5-6-7-8-10				
1/2" • 12-14-16-18				
Č.p.	specifikace			
17255		4		



FÚRÓ ADAPTER KÉSZLET

CrV	1/4"	3x		
R.s.	leírás			
18604	1/4", 3/8", 1/2"	10		



RADIÁTORKULCS

CrV	1/2"			
R.s.	leírás			
17455	pro ráčnu 1/2"	10		



NEW



FESTA

T IMBUSZ + TORX KULCS KÉSZLET

- H 2.5 · 3 · 4 · 5 · 6 · 8 · 10 mm
- ★ T 10 · 15 · 20 · 25 · 30 · 40 · 45

14x CrV

R.sz.	Leírás
18501	



1

FESTA

CSAVARHÚZÓ KÉSZLET

- 2 mm
- 2,5 mm
- 3 mm
- 4 mm
- 5 mm
- 6 mm
- 7 mm
- 8 mm
- 10 mm

9x **CrV**

R.sz.	Leírás
18494	



6

FESTA

T CSAVARHÚZÓ TORX

★ CrV



R.sz.	Leírás	
17350	T 7	10
17351	T 8	10
17352	T 9	10
17353	T 10	10

R.sz.	Leírás	
17357	T 27	10
17359	T 40	10
17361	T 50	10

FESTA

CSAVARHÚZÓ KÉSZLET

- T 10
- T 15
- T 20
- T 25
- T 27
- T 30
- T 40
- T 45
- T 50

9x **CrV**

R.sz.	Leírás
18495	



6

FESTA

IMBUSZKULCS

DIN 911 **CrV**

Č.p.	specifikace	
18567	27 mm 100 x 250 mm	1
18572	32 mm 125 x 315 mm	1



FESTA

IMBUSZKULCS - HOSSZÍTOTT

CrV

Č.p.	specifikace	
18510	1,5 mm 14 x 74 mm	1
18511	2 mm 16 x 81 mm	1
18512	2,5 mm 18 x 88 mm	1
18513	3 mm 23 x 108 mm	1
18514	4 mm 24 x 107 mm	1
18515	5 mm 23 x 118 mm	1
18516	6 mm 32 x 135 mm	1
18518	8 mm 36 x 153 mm	1
18519	9 mm 38 x 155 mm	1
18520	10 mm 40 x 168 mm	1
18521	11 mm 40 x 230 mm	1
18522	12 mm 45 x 237 mm	1
18523	13 mm 45 x 260 mm	1
18524	14 mm 55 x 265 mm	1
18527	17 mm 60 x 298 mm	1



FESTA

IMBUSZKULCS - HOSSZÍTOTT

CrV

Č.p.	specifikace	
18575	1,5 mm 15 x 75 mm	1
18576	2 mm 17 x 81 mm	1
18577	2,5 mm 18 x 87 mm	1
18578	3 mm 20 x 96 mm	1
18579	4 mm 24 x 107 mm	1
18580	5 mm 30 x 120 mm	1
18581	6 mm 33 x 136 mm	1
18582	7 mm 34 x 144 mm	1
18583	8 mm 36 x 153 mm	1
18584	9 mm 38 x 155 mm	1
18585	10 mm 40 x 168 mm	1
18587	12 mm 45 x 237 mm	1
18588	13 mm 45 x 210 mm	1
18589	14 mm 55 x 265 mm	1
18593	17 mm 60 x 298 mm	1



FESTA

TORXKULCS

★ CrV

Č.p.	specifikace	
18476	T45	1



FESTA

IMBUSZKULCS KLT. CRV

- H 1,5 mm
- H 2 mm
- H 2,5 mm
- H 3 mm
- H 4 mm
- H 5 mm
- H 6 mm
- H 8 mm
- H 10 mm



R.s.	leírás	
18496		5

FESTA

IMBUSZKULCS KLT.

- H 1,5 mm
- H 2 mm
- H 2,5 mm
- H 3 mm
- H 4 mm
- H 5 mm
- H 6 mm
- H 8 mm
- H 10 mm



R.s.	leírás	
18500		5

FESTA

IMBUSZKULCS KLT. CRV
HOSSZÍTOTT

- H 1,5 mm
- H 2 mm
- H 2,5 mm
- H 3 mm
- H 4 mm
- H 5 mm
- H 6 mm
- H 8 mm
- H 10 mm



R.s.	leírás	
18490		5

FESTA

IMBUSZKULCS KLT.

- H 1,5 mm
- H 2 mm
- H 2,5 mm
- H 3 mm
- H 4 mm
- H 5 mm
- H 6 mm
- H 8 mm
- H 10 mm



R.s.	leírás	
18498		5

FESTA

IMBUSZKULCS KLT.

- 1/16"
- 5/64"
- 3/32"
- 1/8"
- 5/32"
- 3/16"
- 1/4"
- 5/16"
- 3/8"

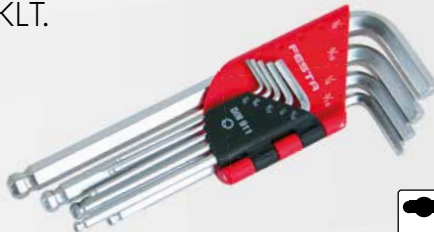

R.s.	leírás	
18493		6

FESTA

TORXKULCS KLT.

- T 10 mm
- T 15 mm
- T 20 mm
- T 25 mm
- T 27 mm
- T 30 mm
- T 40 mm
- T 45 mm
- T 50 mm



R.s.	leírás	
18497		5

FESTA

IMBUSZKULCS KLT. CRV
HOSSZÍTOTT

- H 1,5 mm
- H 2 mm
- H 2,5 mm
- H 3 mm
- H 4 mm
- H 5 mm
- H 6 mm
- H 8 mm
- H 10 mm



R.s.	leírás	
18492		10

FESTA

TORXKULCS KLT. CRV
HOSSZÍTOTT

- T 10 mm
- T 15 mm
- T 20 mm
- T 25 mm
- T 27 mm
- T 30 mm
- T 40 mm
- T 45 mm
- T 50 mm



R.s.	leírás	
18491		5

FESTA

IMBUSZKULCS
KLT. CRV



R.s.	leírás	
18508	1,5 · 2 · 2,5 · 3 · 4 · 5 · 6 mm	1

KÉSZLET
IMBUSZKULCS



R.s.	leírás	
18499	2 · 2,5 · 3 · 4 · 5 · 6 · 8 · 10 mm	1

FESTA

VILLÁSKULCS

CrV DIN 3110



R.sz.	leírás	
17550	6 x 7 mm	10
17551	8 x 9 mm	10
17552	8 x 10 mm	10
17553	10 x 11 mm	10
17590	10 x 13 mm	10
17554	12 x 13 mm	10
17555	14 x 15 mm	10
17556	13 x 16 mm	10
17557	13 x 17 mm	10
17591	14 x 17 mm	10
17558	16 x 17 mm	10
17559	17 x 19 mm	10
17560	18 x 19 mm	10

R.sz.	leírás	
17592	19 x 22 mm	10
17593	19 x 24 mm	10
17561	20 x 22 mm	10
17569	21 x 23 mm	10
17548	22 x 24 mm	10
17562	24 x 27 mm	10
17549	24 x 30 mm	10
17563	30 x 32 mm	10
17564	30 x 34 mm	10
17565	32 x 36 mm	10
17566	36 x 41 mm	10
17567	46 x 50 mm	10
17568	50 x 55 mm	3

FESTA

CSILLAG VILLÁSKULCS

CrV DIN 3113



R.sz.	leírás	
17487	6 mm	10
17570	7 mm	10
17571	8 mm	10
17572	9 mm	10
17573	10 mm	10
17574	11 mm	10
17575	12 mm	10
17576	13 mm	10
17577	14 mm	10
17578	15 mm	10
17579	16 mm	10
17580	17 mm	10
17581	18 mm	10
17582	19 mm	10
17488	20 mm	10

R.sz.	leírás	
17489	21 mm	10
17583	22 mm	10
17490	23 mm	10
17584	24 mm	10
17491	25 mm	10
17492	26 mm	10
17585	27 mm	10
17493	28 mm	10
17494	29 mm	10
17586	30 mm	10
17587	32 mm	10
17495	33 mm	10
17496	34 mm	10
17589	36 mm	10

FESTA

RACSNIS KULCS,
CSUKLÓS

CrV 72T



R.sz.	leírás	
17628	8 mm	10
17622	10 mm	10
17623	13 mm	10
17624	14 mm	10
17629	15 mm	10
17630	16 mm	5

R.sz.	leírás	
17625	17 mm	10
17631	18 mm	10
17626	19 mm	10
17632	21 mm	5
17633	22 mm	5

FESTA

RACSNIS KULCS

CrV 72T



R.sz.	leírás	
17660	6 mm	10
17676	7 mm	10
17661	8 mm	10
17662	9 mm	10
17663	10 mm	10
17664	11 mm	10
17665	12 mm	10
17666	13 mm	10
17667	14 mm	10
17668	15 mm	10

R.sz.	leírás	
17669	16 mm	10
17670	17 mm	10
17671	18 mm	10
17672	19 mm	10
17674	21 mm	5
17675	22 mm	5
17677	24 mm	5
17678	27 mm	5
17679	30 mm	5
17683	32 mm	5

FESTA

VILLÁSKULCS

DIN 895



R.sz.	leírás	
17460	6 x 7 mm	10
17461	8 x 9 mm	10
17462	8 x 10 mm	10
17463	10 x 11 mm	10
17481	10 x 13 mm	10
17464	12 x 13 mm	10
17465	14 x 15 mm	10
17467	13 x 17 mm	10
17482	14 x 17 mm	10
17468	16 x 17 mm	10

R.sz.	leírás	
17469	17 x 19 mm	10
17470	18 x 19 mm	10
17483	19 x 22 mm	10
17484	19 x 24 mm	10
17471	20 x 22 mm	10
17472	24 x 27 mm	10
17486	21 x 23 mm	10
17480	28 x 30 mm	10
17473	30 x 32 mm	10
17485	36 x 41 mm	10

FESTA

CSILLAGKULCS
HAJLÍTOTT

CrV DIN 838



R.sz.	leírás	
17605	6 x 7 mm	10
17606	8 x 9 mm	10
17607	8 x 10 mm	10
17608	10 x 11 mm	10
17609	12 x 13 mm	10
17611	13 x 16 mm	10
17612	13 x 17 mm	10

R.sz.	leírás	
17610	14 x 15 mm	10
17613	16 x 17 mm	10
17614	18 x 19 mm	10
17615	20 x 22 mm	10
17616	24 x 27 mm	10
17617	30 x 32 mm	10

FESTA

VILLÁSKULCS

CrV DIN 3110



R.sz.	leírás	
17761	14 x 15 mm	10
17769	20 x 22 mm	10

FESTA

CSILLAG -
VILLÁSKULCS

CrV DIN 3113



R.sz.	leírás	
17788	14 mm	10
17795	21 mm	10
17806	33 mm	10

FESTA

RACSNIS KULCS KÉSZLET

8-9-10-11-12-13-14-15-16-17-18-19 mm



R.s. 17619

leírás

1



NEW

FESTA

KULCS

Cr-Mo



12-13-14-15 mm

16-17-18-19 mm

R.s. 17685

leírás

12-13-14-15-16-17-18-19 mm

1



FESTA

ÁLLÍTHATÓ VILLÁSKULCS

CrV



R.s.	rozsah	délka	📦
17197	0 - 29 mm	200 mm	1
17198	0 - 33 mm	250 mm	1
17199	0 - 38 mm	300 mm	1



ÁLLÍTHATÓ VILLÁSKULCS

R.s.	rozsah	délka	📦
17200	0 - 24 mm	200 mm	6
17201	0 - 30 mm	250 mm	6
17202	0 - 34 mm	300 mm	6



FESTA



FESTA

CrV DIN 3110

R.s.	leírás	📦
17506	6 db · 6 x 7, 8 x 9, 10 x 11, 12 x 13, 14 x 15, 16 x 17	1
17508	8 db · 6 x 7, 8 x 9, 10 x 11, 12 x 13, 14 x 15, 16 x 17, 18 x 19, 20 x 22	1



FESTA

CSILLAG-VILLÁSKULCS KLT.

CrV DIN 3113

R.s.	leírás	📦
17526	6 db · 10 x 10, 11 x 11, 13 x 13, 14 x 14, 16 x 16, 17 x 17	1
17528	8 db · 8 x 8, 10 x 10, 11 x 11, 13 x 13, 14 x 14, 16 x 16, 17 x 17, 19 x 19	1



FESTA

CSILLAGKULCS KLT.

8x CrV DIN 838

R.s.	leírás	📦
17539	6 x 7, 8 x 9, 10 x 11, 12 x 13, 14 x 15, 16 x 17, 18 x 19, 20 x 22	1



FESTA

CSILLAG-VILLÁSKULCS KLT.

CrV

DIN 3113



R.sz.	leírás	
17532	12 db · 8 x 8, 9 x 9, 10 x 10, 11 x 11, 13 x 13, 14 x 14, 16 x 16, 17 x 17, 18 x 18, 19 x 19, 21 x 21, 22 x 22	10
17533	18 db · 6 x 6, 7 x 7, 8 x 8, 9 x 9, 10 x 10, 11 x 11, 12 x 12, 13 x 13, 14 x 14, 15 x 15, 16 x 16, 17 x 17, 18 x 18, 19 x 19, 20 x 20, 21 x 21, 22 x 22, 24 x 24	1
17534	25 db · 6 x 6, 7 x 7, 8 x 8, 9 x 9, 10 x 10, 11 x 11, 12 x 12, 13 x 13, 14 x 14, 15 x 15, 16 x 16, 17 x 17, 18 x 18, 19 x 19, 20 x 20, 21 x 21, 22 x 22, 23 x 23, 24 x 24, 25 x 25, 26 x 26, 27 x 27, 28 x 28, 30 x 30, 32 x 32	4

FESTA

VILLÁSKULCS KLT.

CrV

DIN 3110

12x



R.sz.	leírás	
17512	6 x 7, 8 x 9, 10 x 11, 12 x 13, 14 x 15, 16 x 17, 18 x 19, 20 x 22, 21 x 23, 24 x 27, 25 x 28, 30 x 32	1

FESTA

VILLÁSKULCS KLT.

DIN 895



R.sz.	leírás	
17475	8 db · 6 x 7, 8 x 9, 10 x 11, 12 x 13, 14 x 15, 16 x 17, 18 x 19, 20 x 22	5
17476	12 db · 6 x 7, 8 x 9, 10 x 11, 12 x 13, 14 x 15, 16 x 17, 18 x 19, 20 x 22, 21 x 23, 24 x 27, 28 x 30, 30 x 32	3



KÖRMÖSKULCS



R.sz.	leírás	
20967	200 mm	15

FESTA

RACSNIS KULCS KÉSZLET

CrV

72T

7x



R.sz.	leírás	
17620	8, 10, 12, 13, 14, 17, 19	5

FESTA

RACSNIS KULCS, CSUKLÓS, KÉSZLET

CrV

72T

7x



R.sz.	leírás	
17621	10, 12, 13, 14, 15, 17, 19	5

FESTA

CSŐKULCS KLT.

CrV

7x



R.sz.	leírás	
17501	6 x 7, 8 x 9, 10 x 11, 12 x 13, 14 x 15, 16 x 17, 18 x 19	20
17640	páka na trubkové klíče · 135 mm	50

FESTA

CSŐKULCS

CrV

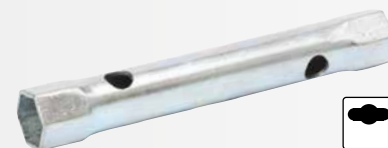

R.sz.	leírás		R.sz.	leírás	
17650	6 x 7 mm	10	17655	16 x 17 mm	10
17651	8 x 9 mm	10	17645	16 x 18 mm	10
17642	8 x 10 mm	10	17653	16 x 21 mm	10
17652	10 x 11 mm	10	17656	18 x 19 mm	10
17643	12 x 13 mm	10	17657	19 x 22 mm	10
17654	14 x 15 mm	10	17659	22 x 24 mm	10
17644	14 x 17 mm	10	17658	24 x 27 mm	10

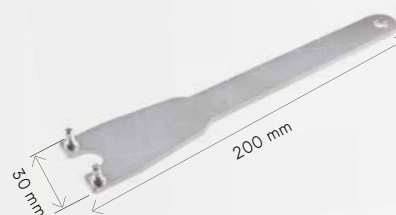

KÖRMÖSKULCS



R.sz.	leírás	
20968	200 mm	1

FESTA

RACSNIS
HAJTÓKAR



R.s.	Leírás	
17452	19 x 22 mm	1



FESTA

RACSNIS
HAJTÓKAR

R.s.	leírás	
17451	18 mm	10
17450	19 mm	10



FESTA

NYOMATÉK KULCS

R.s.	leírás	
17203	1/4" 5 - 25 Nm	1
17204	1/2" 19 - 110 Nm	1
17205	1/2" 42 - 210 Nm	1
17206	3/4" 140 - 700 Nm	1



FESTA

made by **HENITON**

DUGÓKULCS FEJ



Cr-Mo 1/2" 3x



Č.p.	specifikace	
17338	21 mm	5



KERÉK CSAVARKULCS



R.s.	leírás	
17600	17, 19, 22 mm, 13/16"	16

KERÉK CSAVARKULCS



1/2"

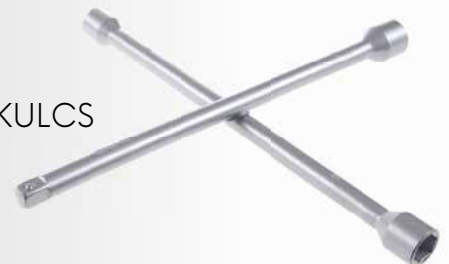

R.s.	leírás	
17601	17, 19, 21 mm	20

KERÉKKULCS,
TELESZKÓPOS

1/2" 3x



R.s.	leírás	
17603	17 x 19 mm, 21 x 23 mm	20

GYERTYAKULCS



R.s.	leírás	
17261	16 mm	1
17262	21 mm	1

FESTA

UNIVERZÁLIS KULCS

CrV



R.sz.	leírás		
17680	19 - 51 mm	165 mm	5
17681	32 - 76 mm	216 mm	5
17682	51 - 121 mm	267 mm	5



CSAPÁGYLEHÚZÓ



R.sz.	max. Ø	leírás	
23734	Ø 100 mm	50-95 mm	1
23735	Ø 150 mm	100-150 mm	1
23736	Ø 200 mm	110-190 mm	1

CSAPÁGYLEHÚZÓ



R.sz.	max. Ø	leírás	
23730	Ø 100 mm	50-95 mm	2
23731	Ø 150 mm	100-150 mm	2
23732	Ø 200 mm	110-190 mm	2

FESTA

RADIÁTORKULCS

CrV 1/2"



R.sz.	leírás	
17455	pro ráčnu 1/2"	10

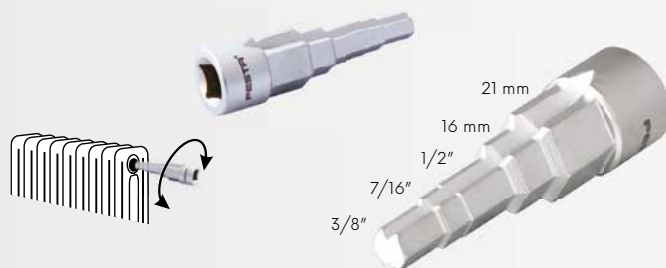

KÉZIU LÉGTELENÍTŐ KULCS

2x



R.sz.	leírás	
17454	5 x 5 mm	1

KÉZIU LÉGTELENÍTŐ KULCS TARTÁLYOS



R.sz.	leírás	
17459	50 ml	1



FESTA

UNIVERZÁLIS KULCS AZ ELOSZTÓSZEKRENYEKHEZ

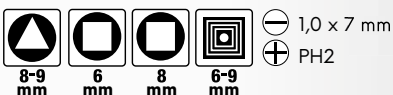

R.sz.	leírás	
17458		1

FESTA

UNIVERZÁLIS KULCS AZ ELOSZTÓSZEKRENYEKHEZ

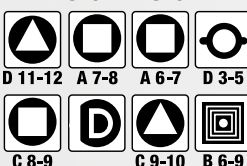

R.sz.	leírás	
17456		50





ERGONOMIC handle

STANDARD +30% FESTA

CrV · króm-vanádium acél

HRC 58-62 · Szorítópofo keménysége

ERGO HANDLE · ergonomikus fogantyúk minőségi TPE gumból

· indukciós edzett



FOGÓ KOMBINÁLT

DIN 5746	TUV GS	R.s.	leírás	
CrV	HRC 58-62	17101	160 mm	6
		17102	180 mm	6
		17103	200 mm	6



OLDALCSÍPŐ FOGÓ

DIN 5749	TUV GS	CrV	HRC 58-62	ERGO HANDLE	R.s.	leírás	
					17148	180 mm	6



OLDALCSÍPŐ FOGÓ

DIN 5749	TUV GS	CrV	HRC 58-62	ERGO HANDLE	R.s.	leírás	
					17104	160 mm	6
					17105	180 mm	6



TELEFON FOGÓ, EGYENES

DIN 5745	TUV GS	CrV	HRC 58-62	ERGO HANDLE	R.s.	leírás	
					17140	160 mm	6
					17142	200 mm	6



TELEFON FOGÓ, HAJLÍTOTT

DIN 5749	TUV GS	CrV	HRC 58-62	ERGO HANDLE	R.s.	leírás	
					17145	160 mm	6
					17146	200 mm	6



FESTA



**FESTA**

FOGÓ KOMBINÁLT

DIN 5746				
R.s.	leírás			
17001	160 mm	6		
17002	180 mm	6		
17003	200 mm	6		

**FESTA**

OLDALCSÍPÓ FOGÓ

DIN 5749				
R.s.	leírás			
17004	160 mm	6		
17005	180 mm	6		

**FESTA**

ERŐSÍTETT OLDALCSÍPÓ FOGÓ

DIN 5749				
R.s.	leírás			
17108	180 mm	6		

**FESTA**

HOMLOKCSÍPÓ FOGÓ

DIN 5748				
R.s.	leírás			
17110	160 mm	6		

**FESTA**

TELEFON FOGÓ, EGYENES

DIN 5745				
R.s.	leírás			
17006	160 mm	6		
17011	200 mm	6		

**FESTA**

TELEFON FOGÓ, HAJLÍTOTT

DIN 5745				
R.s.	leírás			
17007	160 mm	6		
17008	200 mm	6		

**FESTA**

LAPOS FOGÓ

DIN 5746				
R.s.	leírás			
17009	160 mm	6		

**FESTA**

SZEMES FOGÓ

DIN 5745			
R.s.	leírás		
17010	160 mm	6	

**FESTA**

FOGÓ KÁBELCSUPASZÍTÓ

DIN 5744			
R.s.	leírás		
17024	160 mm	6	



FOGÓ KOMBINÁLT

DIN 5746		
R.s.	leírás	
17094	160 mm	6
17095	180 mm	6
17096	200 mm	6



OLDALCSÍPÓ FOGÓ

DIN 5749		
R.s.	leírás	
17097	160 mm	6
17098	180 mm	6



TELEFON FOGÓ, EGYENES

DIN 5745		
R.s.	leírás	
17099	160 mm	6
17100	200 mm	6



VDE KOMBINÁLT FOGÓ

△ 1000 V IEC/EN60900:2004

DIN 5746 CrV HRC 58-62



R.sz.	leírás	
17125	160 mm	6
17126	180 mm	6
17127	200 mm	6



VDE OLDALCSÍPŐ FOGÓ

△ 1000 V IEC/EN60900:2004

DIN 5749 CrV HRC 58-62



R.sz.	leírás	
17128	160 mm	6



VDE HUZALVÁGÓ FOGÓ

△ 1000 V IEC/EN60900:2004

CrV HRC 58-62



R.sz.	leírás	
17130	160 mm	6



TELEFON FOGÓ, EGYENES

△ 1000 V IEC/EN60900:2004

DIN 5745 CrV HRC 58-62



R.sz.	leírás	
17133	160 mm	6



TELEFON FOGÓ, HAJLÍTOTT

△ 1000 V IEC/EN60900:2004

DIN 5745 CrV HRC 58-62



R.sz.	leírás	
17135	160 mm	6



VDE SZEMES FOGÓ

△ 1000 V IEC/EN60900:2004

DIN 5745 CrV HRC 58-62



R.sz.	leírás	
17137	160 mm	6



VDE FOGÓ KÁBELCSUPASZÍTÓ

△ 1000 V IEC/EN60900:2004

CrV DIN 5744



R.sz.	leírás	
17138	160 mm	6



FOGÓ FINOM KÁBELEKHEZ

max Ø 0,2 - 2,1 mm

CrV	R.sz.	leírás	
	17047	140 mm	10



FOGÓ FINOM KÁBELEKHEZ

huzalcsupaszítás - 0,75; 1,0; 1,5; 2,5; 4,0; 6,0mm²

CrV	R.sz.	leírás	
	17087	145 mm	1



AUTOMATA KÁBEL CSUPASZÍTÓ FOGÓ

0,5 - 6 mm²
190 mm



R.sz.	leírás	
17178		1



AUTOMATA KÁBEL CSUPASZÍTÓ FOGÓ

Ø 0,75 - 2,5 mm



R.sz.	leírás	
17180	Ø 0,75 - 2,5 mm	12



BLANKOLÓ FOGÓ

Ø 0,60 - 2,6 mm



R.sz.	leírás	
17181	Ø 0,60 - 2,6 mm	10

NEW



FESTA

KÁBELCSUPASZÍTÓ

· Ø 0,2-4 mm

R.sz. 16205
Leírás 125 mm



1

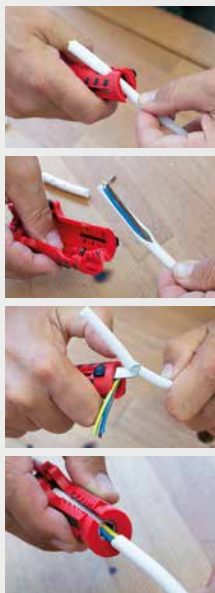

FESTA

KÁBELCSUPASZÍTÓ

AWG	mm ²
10	6,0
12	4,0
14	2,5
16	1,5
18	1,0
20	0,5

· RG6/59 koaxiális kábel
· kifeszültségű kábel Ø 8 - 13 mm

R.sz. 16202
Leírás 125 mm



10



FESTA
INDUSTRY

**KRIMPELŐ
FOGÓ
KÉSZLET**

6x

R.sz. 18445
Leírás



1

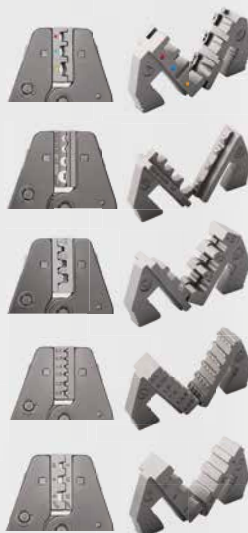

· AWG 22-18/16-14/12-10
· DIN 0,5-1,0/1,5-2,5/4-6mm²

· AWG 20-16/16-14/12-10/8
· DIN 0,5-1,0/1,5-2,5/4-6/10mm²

· AWG 20-18/16-14/12-10
· DIN 0,5-1,0/1,5-2,5/4-6mm²

· AWG 20/18/17/16/14/12
· DIN 0,5/0,75/1,0/1,5/2,5/4,0mm²

· AWG 10/8/6
· DIN 6/10/16mm²

NEW



FESTA
INDUSTRY

**SZIGETELÉS ELTÁVOLÍTÓ
FOGÓ**

R.sz. 16206
Leírás



1



· AWG 10-22
· 0,5-0,6mm²

· AWG 10-22
· 0,5-0,6mm²

· AWG 10-22
· 0,5-0,6mm²

· huzalcsupaszítás
· AWG 10-24
· 0,2-0,6mm²

NEW



FESTA
INDUSTRY

**SZIGETELÉS ELTÁVOLÍTÓ
FOGÓ**

R.sz. 16208
Leírás



1



· 1,5; 2,5; 6,0mm²

· 1,5; 2,5; 6,0mm²

· huzalcsupaszítás · 0,75; 1,0; 1,5; 2,5; 4,0; 6,0mm²

· vágási kapacitás · M2,6; M3; M3,5; M4; M5

NEW



FESTA

MULTIFUNKCIÓS FOGÓ

9 funkció
Eset

CrV

R.s. leírás
16232



12



FESTA

MINI FOGÓ KLT.

4x

R.s. leírás
17040



6



FESTA

FOGÓ KOMBINÁLT MINI

R.s. leírás
17041 110 mm



12



FESTA

MINI OLDALCSÍPÓ FOGÓ

R.s. leírás
17042 110 mm



12



FESTA

MINI HOMLOKCSÍPÓ FOGÓ

R.s. leírás
17043 100 mm



12



FESTA

MINI LAPOSCSÖRŰ FOGÓ

R.s. leírás
17044 120 mm



12



FESTA

MINI SZEMES FOGÓ

R.s. leírás
17045 120 mm



12



ZÉGER FOGÓ

R.s. leírás
17025 klt



10



FESTA

ZÉGER FOGÓ

R.s. leírás
17190 180 mm belső
17191 180 mm külső



6
6



FESTA

ZÉGER FOGÓ

R.s. leírás
17192 180 mm belső
17193 180 mm külső



15
15

FESTA

MULTIFUNKCIÓS FOGÓ

Kerítéshez

CrV



R.sz.	leírás
17109	270 mm



PATENTFOGÓ

Č.p.	specifikace	leírás
17150	220 mm	1



PATENTFOGÓ

Č.p.	specifikace	leírás
17151	225 mm	1



PATENTFOGÓ

Č.p.	specifikace	leírás
17034	220 mm	5



FESTA

PATENTFOGÓ

Č.p.	specifikace	leírás
17036	270 mm	5



PATENTFOGÓ

Č.p.	specifikace	leírás
17035	220 mm	10



FESTA

PATENTFOGÓ

Č.p.	specifikace	leírás
17023	220 mm	6

FESTA

CSÓFOGÓ, SZABÁLYZÓ ANYÁVAL 45°, S

CrV



R.sz.	leírás
17067	1" 330 mm
17068	1,5" 420 mm
17069	2" 540 mm



FESTA

CSÓFOGÓ, SZABÁLYZÓ ANYÁVAL

CrV

R.sz.	leírás
17063	230 mm
17064	300 mm

FESTA

CSÓFOGÓ, SZABÁLYZÓ ANYÁVAL 90°

CrV



R.sz.	leírás
17075	1" 330 mm
17076	1,5" 420 mm
17077	2" 540 mm



FESTA

CSÓFOGÓ, SZABÁLYZÓ ANYÁVAL 90°

CrV



R.sz.	leírás
17070	2,5" 355 mm
17071	3" 455 mm
17072	3,5" 610 mm



CSÓFOGÓ, SZABÁLYZÓ ANYÁVAL

R.sz.	leírás
17065	260 mm
17066	300 mm

FESTA

VÍZPUMPAFOGÓ



CrV

R.sz.	leírás	rozsaq éolístí	☒
16500	180 mm 0 - 40 mm	1	
16501	250 mm 0 - 52 mm	1	
16502	300 mm 0 - 68 mm	1	

FESTA

VÍZPUMPAFOGÓ



CrV

R.sz.	leírás	rozsaq éolístí	☒
17059	180 mm 0 - 30 mm	6	
17061	250 mm 0 - 30 mm	6	
17062	300 mm 0 - 40 mm	6	
17080	400 mm 0 - 84 mm	4	

FESTA

VÍZPUMPAFOGÓ



CrV

R.sz.	leírás	rozsaq éolístí	☒
17084	250 mm 0 - 30 mm	6	

FESTA

VÍZPUMPAFOGÓ



CrV

· large range of jaws

R.sz.	leírás	rozsaq éolístí	☒
17086	250 mm 0 - 50 mm	6	

FESTA

VÍZPUMPAFOGÓ



CrV

R.sz.	leírás	rozsaq éolístí	☒
17081	180 mm 0 - 30 mm	6	
17014	250 mm 0 - 30 mm	6	
17082	300 mm 0 - 50 mm	6	

FESTA

VÍZPUMPAFOGÓ



CrV

R.sz.	leírás	rozsaq éolístí	☒
17079	250 mm 0 - 50 mm	6	

FESTA

VÍZPUMPAFOGÓ



CrV

R.sz.	leírás	rozsaq éolístí	☒
17012	250 mm 0 - 40 mm	6	
17060	300 mm 0 - 50 mm	10	

VÍZPUMPAFOGÓ



R.sz.	leírás	☒
17013	250 mm 0 - 30 mm	6
17033	300 mm 0 - 50 mm	6

MŰANYAG VÉDŐBETÉT FOGÓKHOZ

· alkalmas 17061 és 17079 hez



R.sz.	leírás	☒
17085	1 pár	1

FESTA

DRÓTVÁGÓ FOGÓ



CrV

max. Ø
6 mm

Ç.p.	specifikace	☒
17029	200 mm	6

FESTA

BETONVASVÁGÓ



CrV

max. Ø
12 mm

Ç.p.	specifikace	☒
17039	24' 610 mm	8

**FESTA**

CSAPSZEGVÁGÓ, KÁBELVÁGÓVAL

Cr-Mo

R.sz.	leírás		
17049	18' 450 mm	max. 6 mm < 40 HRC	1

FESTA

CSAPSZEGVÁGÓ

Cr-Mo**HRC 58-62**

R.sz.	leírás	max. Ø drátu	
17051	14' 350 mm	max. 5 mm < 45 HRC	1
17052	18' 450 mm	max. 6 mm < 45 HRC	1
17053	24' 610 mm	max. 8 mm < 45 HRC	1
17054	30' 760 mm	max. 10 mm < 45 HRC	1
17048	36' 900 mm	max. 12 mm < 45 HRC	1

**FESTA**

CSAPSZEGVÁGÓ, KÁBELVÁGÓVAL

· Kábelekhöz és vezetékekhez

Cr-Mo**HRC 58-62**

R.sz.	leírás	max. Ø drátu	max. Ø lanka	max. Ø kabeļu	
17055	14' 360 mm	max. 5 mm < 45 HRC	max. 3,5 mm	max. 8 mm	1
17056	18' 460 mm	max. 6 mm < 45 HRC	max. 5 mm	max. 10 mm	1
17057	24' 610 mm	max. 8 mm < 45 HRC	max. 7 mm	max. 12 mm	1
17058	30' 760 mm	max. 10 mm < 45 HRC	max. 9 mm	max. 14 mm	1
17046	35' 900 mm	max. 12 mm < 45 HRC	max. 10 mm	max. 16 mm	1

**FESTA**

DRÓTVÁGÓ

Cr-Mo**HRC 57-62****max. Ø
4 mm****CrV**

R.sz.	leírás		
17038	8' 210 mm	max. 4 mm < 30 HRC	10

R.sz.	leírás		
17078	200 mm		12

FESTA

DRÓTVÁGÓ

- puha huzal: Ø 6 mm
- közepesen kemény huzal: Ø 5 mm
- kemény huzal: Ø 4 mm



CSAPSZEGVÁGÓ



R.sz.	leírás	max. Ø drátu	
17028	14' 350 mm	max. 5 mm < 30 HRC	30
17020	18' 450 mm	max. 6 mm < 30 HRC	6
17021	24' 610 mm	max. 8 mm < 30 HRC	10
17022	30' 760 mm	max. 10 mm < 30 HRC	5

NEW



FESTA

HOMLOKCSÍPÓ FOGÓ

CrV HRC 58-62

R.sz.	leírás	
17172	200 mm	1



FESTA

HARAPÓ FOGÓ

CrV

R.sz.	leírás	
17300	160 mm	1
17301	180 mm	10
17302	200 mm	6
17303	250 mm	1



FESTA

RABITZ FOGÓ

CrV

R.sz.	leírás	
17305	220 mm	5
17306	250 mm	1
17304	275 mm	6



HARAPÓ FOGÓ

R.sz.	leírás	
17015	160 mm	6
17016	180 mm	6
17017	200 mm	6



RABITZ FOGÓ

R.sz.	leírás	
17019	220 mm	6
17083	275 mm	6



FESTA

BÁDOGOS FOGÓ EGYENES

R.sz.	leírás	
17089	150 x 215 mm	2

NEW



FESTA

BÁDOGOS FOGÓ EGYENES

R.sz.	leírás	
17341	24 x 180 mm	1

NEW



FESTA

BÁDOGOS FOGÓ 45° FOKBAN HAJLÍTOTT

R.sz.	leírás	
17342	24 x 180 mm	1



FESTA

BÁDOGOS FOGÓ EGYENES

R.sz.	leírás	
17093	95 x 270 mm	6



FESTA

BÁDOGOS FOGÓ 45° FOKBAN HAJLÍTOTT

R.sz.	leírás	
17091	50 x 280 mm	10



FESTA

BÁDOGOS FOGÓ 90° FOKBAN HAJLÍTOTT

R.sz.	leírás	
17092	50 x 260 mm	10



FESTA

BÁDOGOS FOGÓ EGYENES

R.sz.	leírás	
17090	50 x 280 mm	10

**FESTA**

LEMEZVÁGÓ OLLÓ

CrV

R.sz.	leírás	
17170	50 250 mm	6



LEMEZVÁGÓ OLLÓ

CrV

R.sz.	leírás	
17167	70 300 mm	5



LEMEZVÁGÓ OLLÓ

CrV

R.sz.	leírás	
17165	60 250 mm	5



LEMEZVÁGÓ OLLÓ

CrV

R.sz.	leírás	
17169	35 250 mm	5

FESTALEMEZVÁGÓ OLLÓ
HOSSZÚ**Cr-Mo** HRC 58-62

R.sz.	leírás	
17113	egyenes	80 300 mm

FESTA

LEMEZVÁGÓ OLLÓ

Cr-Mo HRC 58-62

R.sz.	leírás	
17111	egyenes	40 250 mm
17116	jobbos	40 250 mm
17121	balos	40 250 mm

FESTA

LEMEZVÁGÓ OLLÓ

Cr-Mo HRC 58-62

R.sz.	leírás	
17112	egyenes	40 260 mm
17117	jobbos	40 260 mm
17122	balos	40 260 mm



LEMEZVÁGÓ ADAPTER



R.sz.	leírás	
20364		1



LEMEZVÁGÓ OLLÓ



R.sz.	leírás	
17186	265 mm	6



KAROS LEMEZVÁGÓ

	17175	17177
	max. 4mm	5mm
	max. Ø10mm	Ø12mm
	max. 8x8mm	10x10mm



R.sz.	leírás	
17175	150 mm	1
17177	250 mm	1

LEMEZVÁGÓ ADAPTER

maximális lemezvastagság :

- 1,8 mm - acél
- 1,2 mm - Rozsdamentes
- 2 mm - műanyag, alumínium, réz



R.sz.	leírás	
20363		5



MŰSZAKI OLLÓ

INOX



Č.p.	specifikace	
16420	60 200 mm	12



MŰSZAKI OLLÓ

INOX



Č.p.	specifikace	
17159	65 220 mm	12



MŰSZAKI OLLÓ

INOX



Č.p.	specifikace	
17158	50 150 mm	10



MŰSZAKI OLLÓ

INOX



Č.p.	specifikace	
17160	70 210 mm	12



OLLÓ

INOX

Č.p.	specifikace	
16405	14 cm	24
16406	17 cm	24
16407	19 cm	24
16408	21,5 cm	12



OLLÓ

3x INOX

Č.p.	specifikace	
16401	3 ks	48



FESTA

LYUKASZTÓ FOGÓ



R.s.	leírás	
17185	Ø 2; 2,5; 3; 3,5; 4; 4,5 mm	12



FESTA

DARABOLÓ OLLÓ, PROFILOKHOZ

lecek, csövek, profilok



R.s.	leírás	
17050	60 250 mm ø 17 mm, ø 20 mm, ø 27 mm	8



ÖSSZEKAPCSOLÓ FOGÓ PROFILOKRA



R.s.	leírás	
17187	350 mm	6



ÖSSZEKAPCSOLÓ FOGÓ PROFILOKRA



R.s.	leírás	
17188	250 mm	12



SZEGECSELŐ PROFILOKRA



R.s.	leírás	
17189	255 mm	12



FESTA

FESTA
**SZEGECSELŐ
FOGÓ**
Cr-Mo

 Ø 2,4 mm
 Ø 3,2 mm
 Ø 4,0 mm
 Ø 4,8 mm

R.s.	leírás
24007	200 mm



1

FESTA
**SZEGECSELŐ
FOGÓ**
Cr-Mo

 Ø 2,4 mm
 Ø 3,2 mm
 Ø 4,0 mm
 Ø 4,8 mm

R.s.	leírás
24010	250 mm



12

FESTA
SZEGECSELŐ FOGÓ
Cr-Mo

 Ø 2,4 mm
 Ø 3,2 mm
 Ø 4,0 mm
 Ø 4,8 mm
 Ø 6,4 mm

R.s.	leírás
24017	280 mm



1

FESTA
SZEGECSELŐ FOGÓ
Cr-Mo

 Ø 2,4 mm
 Ø 3,2 mm
 Ø 4,0 mm
 Ø 4,8 mm
 Ø 6,4 mm

R.s.	leírás
24015	530 mm



1



FESTA
SZEGECSELŐ FOGÓ
Cr-Mo

 Ø 2,4 mm
 Ø 3,2 mm
 Ø 4,0 mm
 Ø 4,8 mm

R.s.	leírás
24030	255 mm

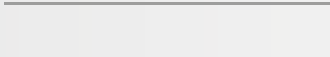

24

FESTA
**SZEGECSELŐ
FOGÓ**
Cr-Mo

 Ø 2,4 mm
 Ø 3,2 mm
 Ø 4,0 mm
 Ø 4,8 mm

R.s.	leírás
24020	290 mm



8





SZEGECESEŐ FOGÓ



Cr-Mo

- Ø 2,4 x 6 mm
- Ø 3,2 x 6 mm
- Ø 4,0 x 6 mm
- Ø 4,8 x 6 mm



SZEGECESEŐ FOGÓ



R.s.	leírás	
24001	260 mm	6

R.s.	leírás	
24005	260 mm	5

R.s.	leírás	
24000	240 mm	24

FESTA

SZEGECESEŐ TARTOZÉK FÚRÓHOZ

- Ø 2,4 mm
- Ø 3,2 mm
- Ø 4,0 mm
- Ø 4,8 mm



Cr-Mo



R.s.	leírás	
24008		1

POPSZEGECS

ALU

50x



R.s.	leírás	
23970	3,2 x 6 mm	25
23971	3,2 x 8 mm	25
23972	3,2 x 10 mm	25
23973	3,2 x 12 mm	25
23974	3,2 x 14 mm	25
23975	4,0 x 6 mm	25
23976	4,0 x 8 mm	25
23977	4,0 x 10 mm	25
23978	4,0 x 12 mm	25
23979	4,0 x 14 mm	25
23985	4,8 x 6 mm	25
23986	4,8 x 8 mm	25
23987	4,8 x 10 mm	25
23988	4,8 x 12 mm	25
23989	4,8 x 14 mm	25



FESTA

SZEGECESEŐ FOGÓ A SZEGECSANYÁKHOZ

Cr-Mo

- M3
- M4
- M5
- M6
- M8
- M10



R.s.	leírás	
24036	330 mm	1

FESTA

SZEGECESEŐ FEJ

· A 24035 és 24036 szerszámokhoz

Cr-Mo



R.s.	leírás	
24038	M3	1
24039	M4	1
24040	M5	1
24041	M6	1
24042	M8	1
24043	M10	1



FESTA

SZEGECESEŐ FOGÓ A SZEGECSANYÁKHOZ

Cr-Mo

- M3
- M4
- M5
- M6



R.s.	leírás	
24035	200 mm	1

SZEGECESEŐ ANYA

ALU

20x







R.s.	leírás	
23950	M3 x 9 mm	20
23951	M4 x 11 mm	20
23952	M5 x 12 mm	50
23953	M6 x 14 mm	50
23954	M8 x 16,5 mm	25
23955	M10 x 18 mm	20



FESTA

TŰZŐGÉP

-  | 6 - 14 mm
23960 - 23964
23760 - 23764,
23906 - 23914
-  | 10 - 14 mm
23965
-  | 15 mm
23966
-  | 15 mm
23967







R.s. leírás
23927

6

FESTA

TŰZŐGÉP

-  | 6 - 14 mm
23960 - 23964
-  | 12 mm
23965
-  | 14 mm
23966
-  | 14 mm
23967





R.s. leírás
23924

12

FESTA

TŰZŐGÉP

-  | 6 - 14 mm
23960 - 23964
-  | 14 mm
23966
-  | 14 mm
23967



R.s. leírás
23923

12



FESTA

TŰZŐGÉP

-  **53** | 4 - 14 mm
23904 - 23914,
23760 - 23765

R.s. leírás
23925

4 - 14 mm with lock

20



TŰZŐGÉP

-  **53** | 4 - 14 mm
23760 - 23765,
23904 - 23914

R.s. leírás
23800

20



TŰZŐGÉP



-  | 0,7 mm
 $\alpha=9-11\text{ mm}, b=5,5\text{ mm}, c=6,4\text{ mm}$

R.s. leírás
23920

4



FESTA

PROFI RÁÜTŐS TŰZŐGÉP

-  | 6 - 10 mm
23960 - 23962

R.s. leírás
23922

10



RÁÜTŐS TŰZŐGÉP

-  | 6 - 10 mm
23960 - 23962

R.s. leírás
23928

6



FESTA

TŰZŐKAPOCS-ELTÁVOLÍTÓ

R.s. leírás
23945

25

FESTA

TŰZŐGÉPKAPOCS



R.sz.	leírás	
23960	b=6 mm, 1000 db	50
23961	b=8 mm, 1000 db	50
23962	b=10 mm, 1000 db	50
23963	b=12 mm, 1000 db	50
23964	b=14 mm, 1000 db	50

FESTA

TŰZŐGÉPKAPOCS

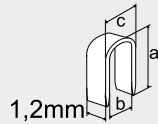

R.sz.	leírás	
23965	α=12 mm, b=6,5 mm, c=7,5 mm, 1000 TW	50

TŰZŐGÉPKAPOCS (TYP 53)

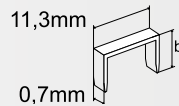

R.sz.	leírás	
23904	b=4 mm 1000 db	200
23906	b=6 mm 1000 db	200
23908	b=8 mm 1000 db	200
23910	b=10 mm 1000 db	200
23912	b=12 mm 1000 db	200
23914	b=14 mm 1000 db	200

**FESTA**

TŰZŐGÉPKAPOCS



R.sz.	leírás	
23966	14 mm 1000 TW	100

FESTA

TŰZŐGÉPKAPOCS



R.sz.	leírás	
23967	14 mm 1000 TW	100

TŰZŐGÉPKAPOCS (TYP 53)

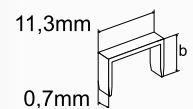
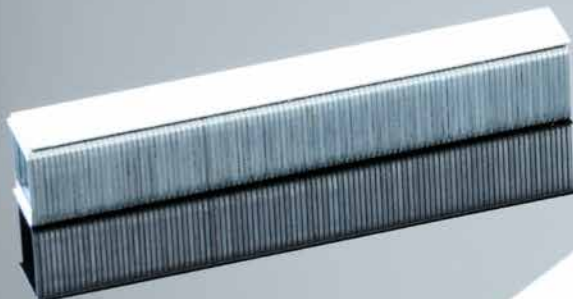
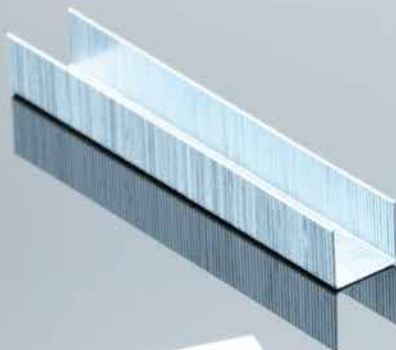

R.sz.	leírás	
23760	b=4 mm 2000 db	10
23761	b=6 mm 2000 db	10
23762	b=8 mm 2000 db	10
23763	b=10 mm 2000 db	10
23764	b=12 mm 2000 db	10

**FESTA**

FESTA



FESTA**DRÓTKEFE
MŰA.NYELŰ**

R.sz.	leírás	soros	
22080	270 mm	5 soros	12

FESTA**DRÓTKEFE
MŰA.NYELŰ**

R.sz.	leírás	soros	
22082	270 mm	5 soros	12

FESTA**BRONZ ÉS
FÉM SZÁLAS
DRÓTKEFE
KÉSZLET**

Nylon, acél, sárgaréz

3x

R.sz.	leírás	
22086	180 mm	12

**BRONZ ÉS
FÉM SZÁLAS
DRÓTKEFE
KÉSZLET****3x**

R.sz.	soros	
22081	3 soros	12

22158



22159

**DRÓT ECSET**

R.sz.	leírás	huzal	
22158	200 mm	acél	1
22159	200 mm	sárgaréz	1

22035



22036

**DRÓTKEFE MŰA.NYELŰ**

R.sz.	leírás	huzal	
22035	270 mm	acél	24
22036	270 mm	rozsdamentes acél	24

**DRÓTKEFE**

R.sz.	leírás	soros	
22033	300 mm	4 soros	12
22034	300 mm	5 soros	12

**BRONZSZÁLAS DRÓTKEFE, FÁRA**

· sárgaréz bevonattal

R.sz.	soros	
22078	3 soros	20

**BRONZSZÁLAS DRÓTKEFE, FÁRA**

· sárgaréz bevonattal

R.sz.	leírás	soros	
22079	300 mm	4 soros	6



FESTA



FESTA HÁROMSZÖGŰ RESZELŐ



R.sz.	leírás	érdesség	
22178	150 mm	1	10

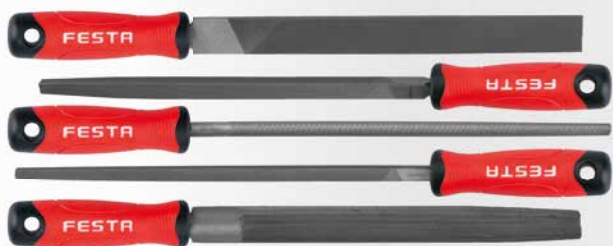

FESTA FÉMRESZELŐ KÉSZLET



R.sz.	leírás	érdesség	
22209	150 mm	2	10
22186	250 mm	2	5



FESTA LAPOS FÉMRESZELŐ



R.sz.	leírás	érdesség	
22206	150 mm	2	10
22180	250 mm	2	10



FESTA FÉLGÖMBÖLYŰ FÉMRESZELŐ



R.sz.	leírás	érdesség	
22207	150 mm	2	10
22182	250 mm	2	10



FESTA NÉGYSZÖGŰ FÉMRESZELŐ



R.sz.	leírás	érdesség	
22184	250 mm	2	10



FESTA HÁROMSZÖGŰ FÉMRESZELŐ



R.sz.	leírás	érdesség	
22183	250 mm	2	10



FESTA GÖMBÖLYŰ FÉMRESZELŐ



R.sz.	leírás	érdesség	
22181	250 mm	2	10



FESTA FÉMRESZELŐ KÉSZLET



R.sz.	leírás	érdesség	
22208	150 mm	2	10
22185	250 mm	2	5



FESTA

LÁNCFŰRÉSZ RESZELŐ



R.sz.	leírás	
22170	200 mm 3,5 mm	10
22171	200 mm 4 mm	10
22172	200 mm 4,5 mm	10

R.sz.	leírás	
22173	200 mm 5 mm	10
22174	200 mm 5,5 mm	10



Ø 4 mm

FESTA

LÁNCFŰRÉSZ RESZELŐ ADAPTER



R.sz.	leírás	
22190	300 mm	5



FESTA

TÚRESZELŐ



10x	R.sz.	leírás	
	22188		20



FESTA

GYÉMÁNT RESZELŐ



10x	R.sz.	leírás	
	22189		25



FESTA

RÁSPOLY



R.sz.	leírás	
22202	150 mm	10
22197	300 mm	10



FESTA

RÁSPOLY KÉSZLET



3x	R.sz.	leírás	
	22196	250 mm	5



FESTA

RÁSPOLY



R.sz.	leírás	
22203	150 mm	6
22199	300 mm	6



FESTA

RÁSPOLY



R.sz.	leírás	
22204	150 mm	10
22205	250 mm	10
22198	300 mm	10



FESTA

FÉMFŰRÉSZ ERGONOMIKUS



R.sz.	leírás	
24104	300 mm	6

FESTA

FÉMFŰRÉSZ

· nehéz szolgálat



R.sz.	leírás	
24102	300 mm	6

FÉMFŰRÉSZ

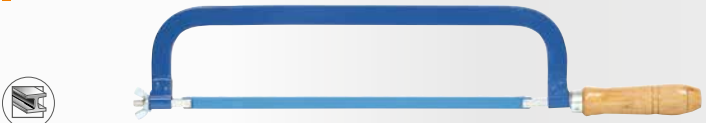

R.sz.	leírás	
24153	300 mm	12

FESTA

FÉMFŰRÉSZ



R.sz.	leírás	
24100	300 mm	12

FÉMFŰRÉSZ



R.sz.	leírás	
24170	300 mm	12

FESTA

FÉMFŰRÉSZ



R.sz.	leírás	
24126	300 x 25 x 0,65 mm TPI 24 14	10

FESTA

FÉMFŰRÉSZ

· fűrészlap 24108

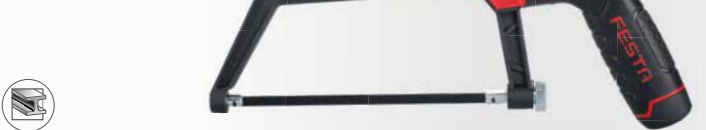

R.sz.	leírás	
24125	150 mm	6

FESTA

FÉMFŰRÉSZ

· fűrészlap 24109



R.sz.	leírás	
24124	260 mm	1210

FŰRÉSZ

R.sz.	leírás	
24121		12
24110	fűrészlap	30



FŰRÉSZ

· 5x fűrészlap

R.sz.	leírás	
24122		20
24111	fűrészlap	30

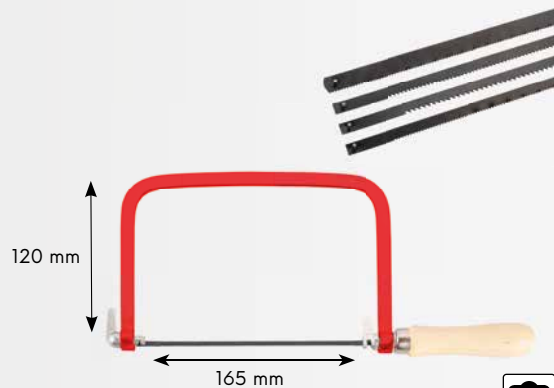

FESTA

RÓKAFARK FŰRÉSZ

TEFLON · 3x élezett, edzett fogazás

R.sz.	leírás	
24143	300 mm	12
24144	400 mm	12
24145	500 mm	12



FESTA

ILLESZTŐ FŰRÉSZ

TEFLON · 3x élezett, edzett fogazás

R.sz.	leírás	
24147	300 mm	6



FESTA

LYUKFŰRÉSZ

· 3x élezett, edzett fogazás

R.sz.	leírás	
24149	300 mm	12



FESTA

JAPÁN FŰRÉSZ

SK5 · 3x élezett, edzett fogazás

R.sz.	leírás	
24134	250 mm 0,5 mm	10



FESTA

JAPÁN FŰRÉSZ

SK5 · 3x élezett, edzett fogazás

R.sz.	leírás	
24115	260 mm 0,6 mm	10



FESTA

JAPÁN FŰRÉSZ

SK5 · 3x élezett, edzett fogazás

R.sz.	leírás	
24114	260 mm 0,6 mm	10

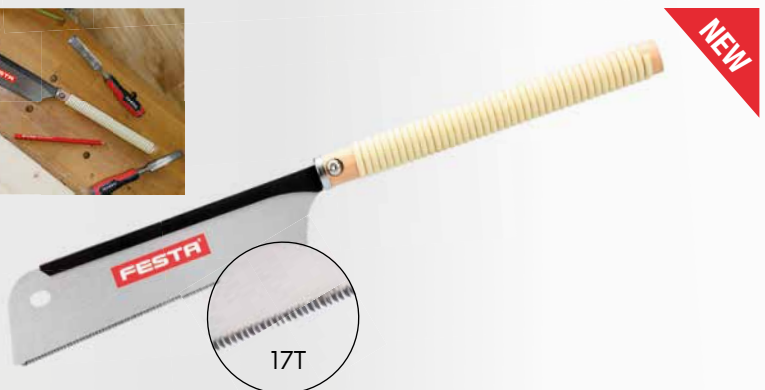

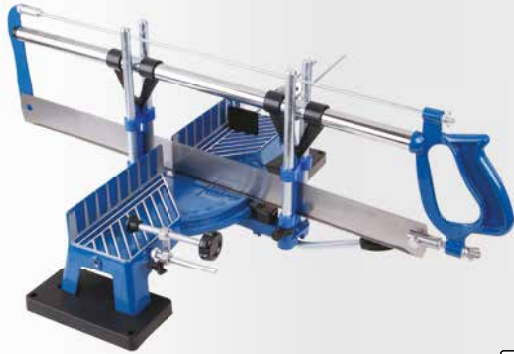

GHÉRVÁGÓ FŰRÉSZ



R.sz.	leírás	
24130	600 mm	1
24131	600 mm, fűrészlap	1



GÉRVÁGÓ FŰRÉSZ + LÁDA



R.sz.	leírás	
24148	300 mm	25

GHÉRLÁDA FA



R.sz.	leírás	
24171	80 x 300 mm	10

GHÉRLÁDA MŰA.



R.sz.	leírás	
24133	300 x 140 mm	18

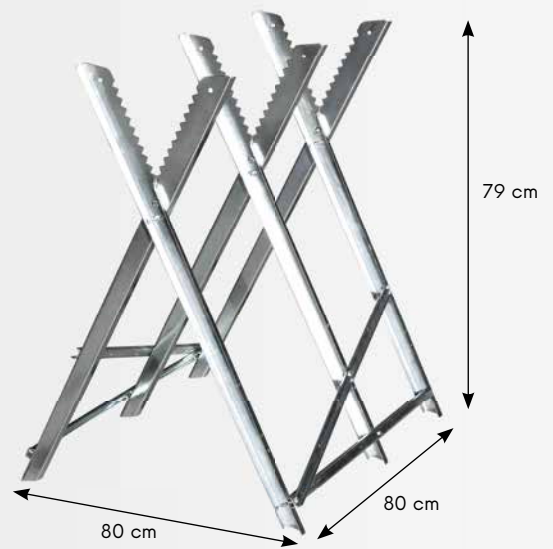

FAVÁGÓ ÁLLVÁNY



R.sz.	leírás	
37570	max. 150 kg	3

FESTA

EGYKEZES ÁGVÁGÓ-FŰRÉSZ

edzett fogazás



R.sz.	leírás		R.sz.	leírás	
24141	450 mm	12	24136	760 mm	12
24140	533 mm	12	24142	800 mm	12
24135	610 mm	12	24137	914 mm	12

FESTA

EGYKEZES ÁGFŰRÉSZ, FORG.

edzett fogazás



R.sz.	leírás	
24173	350 mm	24

KERETES FAFŰRÉSZ



R.sz.	leírás	
24151	300 mm	10

GALLYAZÓ FŰRÉSZ



R.sz.	leírás	
24150	300 mm	5

FŰRÉSZ

R.sz.	leírás	
24128	450 mm fűrészlap 24192	6



FESTA

BECSUKHATÓ KERTIFŰRÉSZ



3x élezett, edzett fogazás



R.sz.	leírás	
45061	150 mm összecukható	12



FESTA

BECSUKHATÓ KERTIFŰRÉSZ



3x élezett, edzett fogazás



R.sz.	leírás	
45060	180 mm	6



FESTA

KERTIFŰRÉSZ TOKKAL



3x élezett, edzett fogazás



R.sz.	leírás	
45062	260 mm esettel	24



ÍVES ÁGVÁGÓ FŰRÉSZ



3x élezett, edzett fogazás

R.sz.	leírás	
24152	350 mm 6 tpi	12

FESTA

TELESZKÓPOS ÁGVÁGÓ FŰRÉSZ



3x élezett, edzett fogazás

R.sz.	leírás	
45033	230 - 490 mm	1



ÁGVÁGÓ FŰRÉSZ

R.sz.	leírás	
45030	fűrész 30 cm teleszkópos pólus 260 cm	6
45031	fűrész 30 cm	6



ÁGVÁGÓ FŰRÉSZ

R.sz.	leírás	
45032	Fém, fűrész nélkül	6



FESTA

POLYSTIROL FÜRÉSZ



R.sz.	leírás	
24174	380 mm	1

FESTA

GIPSZKARTON FÜRÉSZ



3x élezett, edzett fogazás



R.sz.	leírás	
24159	150 mm	12

FESTA

YTONG FÜRÉSZ



R.sz.	leírás	
24181	550 mm	1

GIPSZKARTON LYUKFÚRÓ



R.sz.	leírás	
24190	270 mm	10

FESTA

YTONG FÜRÉSZ



R.sz.	leírás	
24158	22 22 SK fogú - 450 mm	5

FESTA

YTONG FÜRÉSZ



R.sz.	leírás	
24155	34 17 SK fogú - 600 mm	2
24156	34 34 SK fogú - 600 mm	2

FESTA

YTONG FÜRÉSZ

edzett fogazás



R.sz.	leírás	
24175	bez SK fogú - 600 mm EU	2
24178	bez SK fogú - 600 mm	6

FESTA

YTONG FÜRÉSZ

R.sz.	leírás	
24176	34 17 SK fogú - 750 mm	6
24177	34 34 SK fogú - 750 mm	6



**FESTA****KALAPÁCS**

· kőrisfa nyél

**DIN
1041**

R.sz.	leírás	
19081	100 g	1
19082	200 g	1
19083	300 g	1
19084	400 g	1
19085	500 g	1
19086	600 g	1
19088	800 g	1
19090	1000 g	1
19092	1500 g	1
19095	2000 g	1

**FESTA****KALAPÁCS**

· kőrisfa nyél

**DIN
1041**

R.sz.	leírás	
19096	3000 g	1
19097	4000 g	1
19098	5000 g	1
19106	6000 g	1
19108	8000 g	1
19109	10000 g	1

**FESTA****KÉZIKALAPÁCS**

· kőrisfa nyél

**DIN
6475**

R.sz.	leírás	
19041	1000 g	1
19042	1250 g	1
19043	1500 g	1
19044	2000 g	1

FESTA**KÉZIKALAPÁCS**

· kőrisfa nyél

**DIN
6475**

R.sz.	leírás	
19045	3000 g	1
19046	4000 g	1
19074	5000 g	1
19075	6000 g	1
19076	8000 g	1
19077	10000 g	1

**FESTA****KALAPÁCS
ÜVEGSZÁLAS**

· fiberglass

Č.p.	specifikace	
19021	100 g	12
19022	200 g	12
19023	300 g	12
19024	400 g	12
19025	500 g	12
19026	600 g	6
19028	800 g	6
19030	1000 g	6
19031	1500 g	6
19032	2000 g	1

FESTA**KÉZIKALAPÁCS
ÜVEGSZÁLAS**

· fiberglass

**DIN
6475**

Č.p.	specifikace	
19066	1000 g	4
19067	1250 g	4
19068	1500 g	4
19069	2000 g	2

FESTA**KALAPÁCS
ÜVEGSZÁLAS**

· fiberglass



Č.p.	specifikace	
19034	3000 g	4
19036	4000 g	4

FESTA**KÉZIKALAPÁCS
ÜVEGSZÁLAS**

· fiberglass

**DIN
6475**

Č.p.	specifikace	
19070	3000 g	4
19071	4000 g	4
19058	5000 g	4
19059	6000 g	2

FESTA**PALÁZÓ KALAPÁCS
ÜVEGSZÁLAS
NYÉL**

· fiberglass



Č.p.	specifikace	
19061	600 g	6

FESTA**SUSZTER
KALAPÁCS
ÜVEGSZÁLAS NYÉL**

· fiberglass

Č.p.	specifikace	
19064	450 g	6

**FESTA****PALÁZÓ
KALAPÁCS
MONOLIT**

Č.p.	specifikace	
19062	600 g	6

FESTA**SUSZTER
KALAPÁCS
MONOLIT**

Č.p.	specifikace	
19063	450 g	6

**PALÁZÓ
KALAPÁCS**

Č.p.	specifikace	
19100	600 g	6

FESTA**KŐMŰVES
KALAPÁCS
MONOLIT**

Č.p.	specifikace	
19150	600 g	6

**FESTA****PALÁZÓ
KALAPÁCS**

Č.p.	specifikace	
19060	600 g	6

FESTA**SUSZTER
KALAPÁCS**

Č.p.	specifikace	
19065	450 g	6

**FESTA****KŐMŰVES
KALAPÁCS
ÜVEGSZÁLAS NYÉL**

· fiberglass

Č.p.	specifikace	
19151	600 g	6

**FESTA****KŐMŰVES KALAPÁCS**

· kőrisfa nyél

Č.p.	specifikace	
19149	44 mm	1

**FESTA****KŐMŰVES KALAPÁCS**

· kőrisfa nyél

Č.p.	specifikace	
19124	24 mm	1
19136	36 mm	1
19148	48 mm	1

**FESTA****KALAPÁCS - FEJSZE**

Č.p.	specifikace	
19303	600 g	6



FESTA

KÉZIKALAPÁCS

Č.p.	specifikace	
19051	1000 g	6
19052	1500 g	6



KÉZIKALAPÁCS

· kör alakú ék

DIN 6475

Č.p.	specifikace	
19053	1000 g	6
19050	1250 g	6
19054	1500 g	6
19055	2000 g	6

KALAPÁCS

· kör alakú ék

DIN 1041

Č.p.	specifikace	
19001	100 g	12
19002	200 g	12
19003	300 g	6
19004	400 g	6
19005	500 g	6
19006	600 g	6
19008	800 g	6
19010	1000 g	6
19015	1500 g	6
19020	2000 g	6

KÉZIKALAPÁCS

· kör alakú ék

DIN 6475

Č.p.	specifikace	
19056	3000 g	6
19057	4000 g	6

HEGESZTŐ
KALAPÁCS

Č.p.	specifikace	
19115	320 g	1

**FESTA**

KŐMŰVES KALAPÁCS NYÉL

R.s.	leírás	
61240	násada	1

NÁKÉSZLET
NA KALAPÁCS BÜKKFA

R.s.	leírás	kalapácsnak	
61320	26 cm	19081	10
61321	28 cm	19082	10
61322	30 cm	19083	10
61323	31 cm	19084	10
61324	32 cm	19085	10



R.s.	leírás	kalapácsnak	
61325	33 cm	19086	10
61326	35 cm	19088	10
61327	36 cm	19090	10
61328	38 cm	19092	10
61329	40 cm	19095	10

KÉZIKALAPÁCS NYÉL



R.s.	leírás	kézikalapács	
61330	80 cm	19074, 19075	10
61331	90 cm	19076, 19077	10



SZERSZÁMNYÉL ÉK, KÚPOS

R.s.	leírás	
19430	6 mm	10
19431	8 mm	10
19432	10 mm	10
19433	12 mm	10
19434	14 mm	10
19435	16 mm	10



ÉK



R.s.	leírás	
19440	narrow	10
19441	middle	10
19442	wide	10
19443	wide S	10

**FESTA**

ÉK

**3x**

R.s.	leírás	
19398	20 x 25 x 5 mm	1
19399	30 x 40 x 5 mm	1





FESTA

KÉZIKALAPÁCS FÁBÓL

· bükkfa nyél



R.sz.	leírás	
19202	Ø 60 x 120 mm	260 g



FESTA

GUMI KALAPÁCS

· kőrisfa nyél



R.sz.	leírás	
19245	Ø 55 mm	400 g
19246	Ø 60 mm	800 g
19247	Ø 70 mm	1000 g
19248	Ø 95 mm	2000 g
19249	Ø 115 mm	3000 g

FESTA

GUMI KALAPÁCS

· üvegszálás nyél



R.sz.	leírás	
19270	Ø 55 mm	6
19271	Ø 65 mm	6
19272	Ø 90 mm	6



FESTA

GUMI KALAPÁCS



R.sz.	leírás	
19255	Ø 55 mm	6
19265	Ø 65 mm	6
19290	Ø 90 mm	6



FESTA

GUMI KALAPÁCS, FEHÉR

· üvegszálás nyél

R.sz.	leírás	
19281	680g	6



NEW

FESTA

GUMI KALAPÁCS, FEHÉR



R.sz.	leírás	
19293	Ø 55 mm	6
19294	Ø 65 mm	6
19295	Ø 90 mm	6



FESTA

SÁRGARÉZ KALAPÁCS

· üvegszálás nyél

R.sz.	leírás	
19211	Ø 30 mm 500 g	1



FESTA

NYLON KALAPÁCS

· üvegszálás nyél



R.sz.	leírás	
19209	Ø 34 mm	6



GUMI KALAPÁCS



R.sz.	leírás	
19251	Ø 55 mm 400 g	12
19252	Ø 65 mm 700 g	6
19253	Ø 90 mm 1300 g	4



GUMI KALAPÁCS, FEKETE-FEHÉR



R.sz.	leírás	
19254	Ø 65 mm	6



DOMBORÍTÓ KALAPÁCS

R.sz.	leírás	
19297	Ø 30 mm	12



FESTA

KALAPÁCS CSERÉLHETŐ VÉGEKKEL

- PP - 97 Shore A ·
- TPU - 95 Shore A ·
- TPE - 90 Shore A ·
- TPE - 90 Shore A ·
- TPU - 92 Shore A ·
- TPU - 92 Shore A ·
- TPU - 88 Shore A ·
- TPE - 90 Shore A ·

R.sz.	leírás	
19208	Ø 38 mm	1

BÁDOGOS KÉSZLET

7x

R.sz. 19110 leírás



5



FESTA

PAJSZER



R.sz. 19420 leírás 300 mm 1



FESTA

PAJSZER

R.sz.	leírás	box icon
19424	400 mm	6
19425	600 mm	6
19426	800 mm	6
19427	1000 mm	6



PAJSZER

R.sz.	leírás	box icon
19416	600 mm Ø 16 mm	4
19422	800 mm Ø 16 mm	4
19421	1000 mm Ø 18 mm	4



SZEGHÚZÓ

R.sz.	leírás	box icon
19423	380 x 35 x 6 mm	1



SZÖGHÚZÓ

R.sz.	leírás	box icon
19415	300 mm Ø 15 mm	6



FESTA

**FESTA**

LAPOSVÉSŐ

CrV	R.s.	leírás	szélesség hrotu	
	19406	300 mm	25 mm	5
	19407	400 mm	30 mm	5

**FESTA**

SPICCVÉSŐ

CrV	R.s.	leírás	szélesség hrotu	
	19408	250 mm		5
	19409	350 mm		5

**FESTA**

LAPOSVÉSŐ

CrV	R.s.	leírás	szélesség hrotu	
	19460	300 mm	25 mm	5
	19470	400 mm	30 mm	5



SPICCVÉSŐ

R.s.	leírás	
19400	250 mm	5
19403	350 mm	6



LAPOSVÉSŐ

R.s.	leírás	szélesség hrotu	
19401	250 mm	19 mm	6
19404	350 mm	22 mm	6



LAPOSVÉSŐ

R.s.	leírás	szélesség hrotu	
19402	250 mm	50 mm	2
19405	350 mm	50 mm	6

**FESTA**VÉSŐ, LYUKASZTÓ,
PONTOZÓ

12x CrV

- 2, 6, 8 mm
- 10, 12, 16 mm
- Ø 1,5-3-4-5-6-8 mm

R.s.	leírás	
19487		4

**FESTA**VÉSŐ, LYUKASZTÓ,
PONTOZÓ

6x CrV

- 2 x 140, 8 x 115 mm
- 12 x 152, 10 x 142 mm
- Ø 3 x 152, 6 x 152 mm

R.s.	leírás	
19486		10

**FESTA**

VÉSŐ KLT.

3x CrV

- 10, 12, 16 mm

R.s.	leírás	
19485		10

**FESTA**

SPICCVÉSŐ

CrV

R.s.	leírás	
19429	200 mm	1

**FESTA**

LAPOSVÉSŐ

CrV

R.s.	leírás	szélesség hrotu	
19410	200 mm	20 mm	10
19411	250 mm	25 mm	10
19412	300 mm	25 mm	10
19418	400 mm	25 mm	5
19419	500 mm	25 mm	5



LAPOSVÉSŐ

CrV

R.s.	leírás	szélesség hrotu	
19436	200 mm	20 mm	15

FESTA

LYUKASZTÓK CRV

CrV 3x

R.s.	leírás
19480	Ø 0,8, 1,5, 2,5 mm



FESTA

PONTOZÓK CRV

CrV 3x

R.s.	leírás
19481	Ø 0,8, 1,5, 2,5 mm



FESTA

LYUKASZTÓK CRV

CrV 6x

R.s.	leírás
19483	Ø 3, 4, 5, 6, 7, 8 mm



FESTA

PONTOZÓ

CrV

R.s.	leírás
19477	Ø 2,5 mm



FESTA

AUTOMATA PUNTOZÓ

CrV

R.s.	leírás
19478	Ø 2,5 mm



FESTA

LYUKASZTÓK

CrV

R.s.	leírás
19472	Ø 4 mm 150 mm
19473	Ø 5 mm 150 mm
19474	Ø 6 mm 150 mm



RS-G ÜVEGVÁGÓ



R.s.	leírás
20350	130 mm



LYUKASZTÓ

13x

R.s.	leírás
24695	Ø 5, 6, 8, 10, 11, 13, 16, 19, 22, 25, 28, 32, 35 mm



LYUKASZTÓ

24690 - Ø 2,5 mm	24691 - Ø 2 mm
Ø 3 mm	Ø 2,5 mm
Ø 4 mm	Ø 3,2 mm
Ø 5 mm	Ø 4 mm
Ø 6 mm	Ø 4,8 mm
Ø 7 mm	Ø 5 mm
Ø 8 mm	Ø 6,4 mm
Ø 9 mm	Ø 8 mm
Ø 10 mm	Ø 9,5 mm
	Ø 11,1 mm
	Ø 12,7 mm
	Ø 14 mm
	Ø 15,8 mm
	Ø 19 mm
	Ø 22 mm

R.s.	leírás
24690	9 db Ø 2,5 - 10 mm
24691	15 db Ø 2 - 22 mm



BETŰ BEŰTŐ

SZÁM BEŰTŐ

R.s.	leírás
20972	6 mm
20973	8 mm



R.s.	leírás
20970	6 mm
20971	8 mm

FESTA
INDUSTRY

SZORÍTÓ

Č.p.	specifikace	
23625	150 mm	6
23626	300 mm	6
23628	450 mm	6
23630	600 mm	6
23632	760 mm	6



NEW

FESTA
INDUSTRY
HOSSZABBÍTÓ
TENGYELKAPCSOLÓ
BILINCSEKHEZ

FESTA INDUSTRY 23625, 23626, 23628, 23630

2x



R.sz.	Leírás	
23635		6

FESTA
QUICK GRIP
SZORÍTÓ

Č.p.	specifikace	
23570	100 x 80 mm	1
23571	160 x 80 mm	1
23572	200 x 80 mm	1
23573	250 x 80 mm	1
23574	300 x 80 mm	1

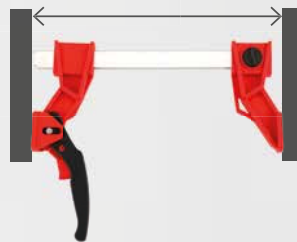
FESTA

PILLANATSZORÍTÓ

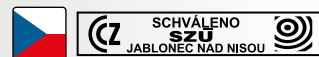

Č.p.	specifikace	
23670	150 x 105 mm	1
23671	200 x 105 mm	1
23672	250 x 105 mm	1
23673	300 x 105 mm	1
23674	350 x 105 mm	1
23675	400 x 175 mm	1
23676	500 x 175 mm	1
23677	600 x 175 mm	1
23678	700 x 175 mm	1
23679	800 x 175 mm	1
23680	1000 x 175 mm	1
23681	1250 x 175 mm	1
23682	1500 x 175 mm	1
23683	1750 x 175 mm	1
23684	2000 x 175 mm	1
23685	2200 x 175 mm	1

FESTA
PILLANAT-
SZORÍTÓ

Č.p.	specifikace	
23585	150 mm	6
23587	300 mm	6
23589	450 mm	6
23591	600 mm	6



FESTA
SZORÍTÓ

- kovácsolt
- picatúra forjatá

Č.p.	specifikace	
23560	200 x 80 mm	1
23561	300 x 100 mm	1
23562	400 x 100 mm	1
23563	500 x 120 mm	1
23564	600 x 120 mm	1
23565	800 x 120 mm	1
23566	1000 x 120 mm	1



PILLANATSZORÍTÓ

DIN 5117

Č.p.	specifikace	
23506	300 x 120 mm	10
23507	500 x 120 mm	10
23508	800 x 120 mm	6

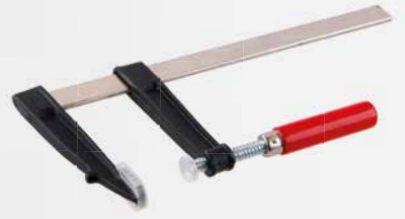

PILLANATSZORÍTÓ

Č.p.	specifikace	
23515	150 x 50 mm	50
23520	200 x 50 mm	50
23525	250 x 50 mm	50
23530	300 x 50 mm	50
23531	300 x 120 mm	20
23551	500 x 120 mm	10



NEW



FESTA
SZORÍTÓ

R.sz.	Leírás	
23595	250/ Ø 20 mm 60 kg	1



NEW



FESTA
SZORÍTÓ

R.sz.	Leírás	
23598	120/ Ø 20 mm 70 kg	1

NEW

FESTA
TÖBBFUNKCIÓS
ÖV BILINCS
FAMEGMUNKÁLÁSHOZ

R.sz.	Leírás	
23637	4m x 25mm	1

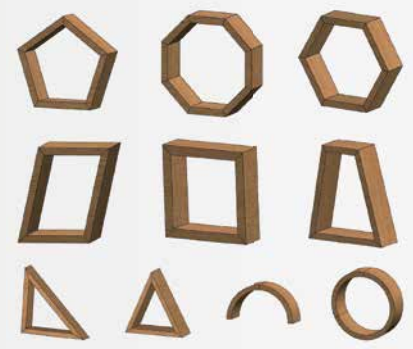



FESTA

90° SATU



4x

R.sz.	leírás	
23607	szorítóerő - 250 N	1

SATU 90°

ALU

· hatótávolság 0-65 mm



R.sz.	leírás	
23420	65 mm	20



RACSNIS SZORÍTÓ

arasz 80 mm

R.sz.	leírás	
23605	9' 230 mm	6



MŰANYAG CSIPESZ

R.sz.	leírás	
23600	4', arasz 40 mm	20
23601	6', arasz 70 mm	12
23602	9', arasz 100 mm	20



G - SZORÍTÓ KÉSZLET

3x

R.sz.	leírás	
23620	25 mm, 50 mm, 75 mm	10



FESTA



MŰHELY

208 - 243

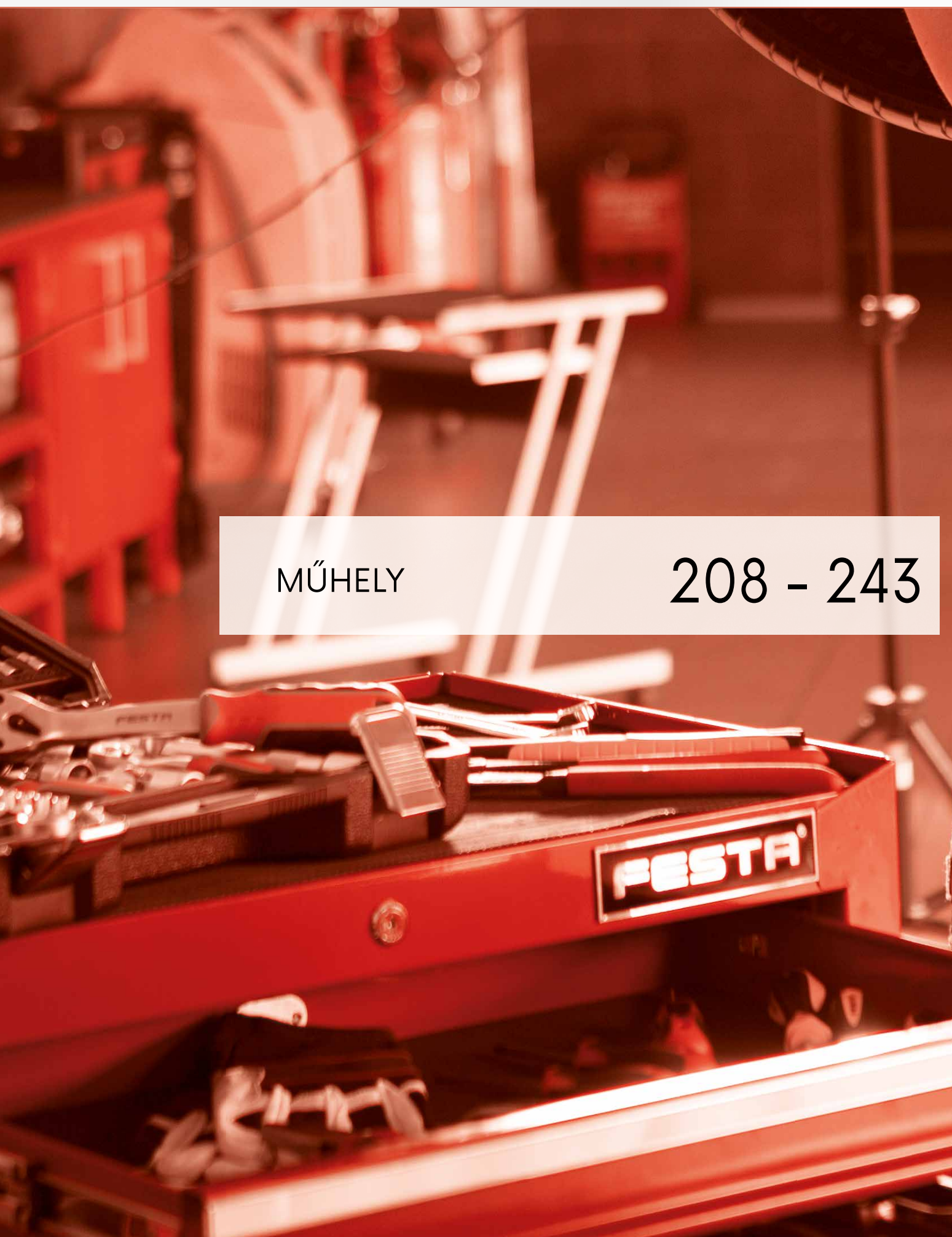

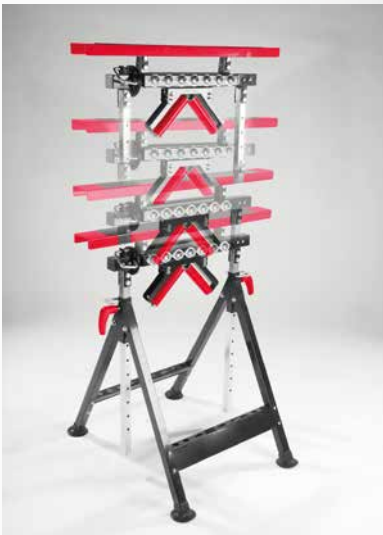

max 200 kg



max 45 kg



max 100 kg



max 100 kg



FESTA

ÁLLÍTHATÓ BAK

· max. terhelés: 200 kg

R.sz. Leírás

36410



1

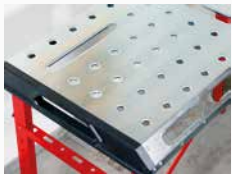

FESTA

ÁLLÍTHATÓ FÉM ASZTAL

· max. terhelés: 450 kg

R.sz. Leírás

23652



1



FESTA

ÁLLÍTHATÓ BAK

· max. terhelés 590 kg

R.sz. Leírás

23657



1



NEW



2x



4x

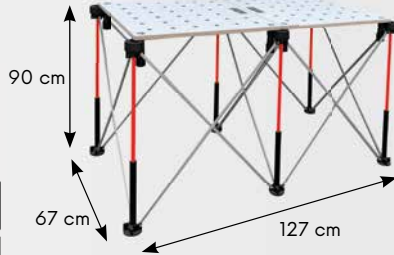

FESTA

**MOBIL MUNKAASZTAL 3x2
KOMPATIBILIS A 23664-EL**

- 1270 x 670 x 900 mm
- max. terhelés: 1100 kg



R.s. Leírás
23661

1

NEW



FESTA

**MUNKALAP
KOMPATIBILIS A 23661-EL**

- 1200 x 600 x 18 mm



R.s. Leírás
23664

1



FESTA

ÁLLÍTHATÓ BAK

- max. terhelés: 230 kg



R.s. leírás
23658

1

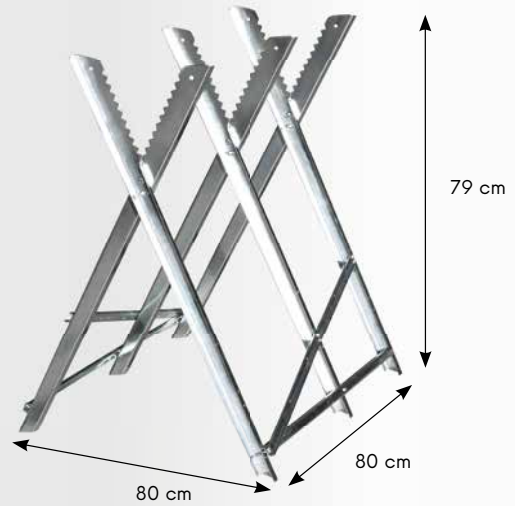

ÁLLÍTHATÓ BAK

- max. terhelés: 150 kg



R.s. leírás
37570

1

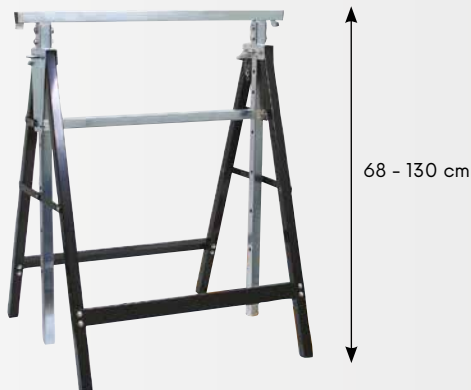

ÁLLÍTHATÓ BAK

- max. terhelés: 125 kg



R.s. leírás
36300

1



ÁLLÍTHATÓ BAK - MŰANYAG

- max. terhelés 150 kg (300 kg a kezében)

2x

R.s. leírás
37560

1

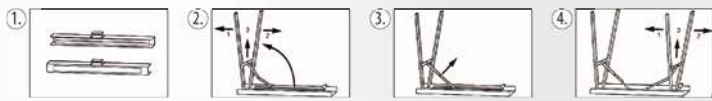
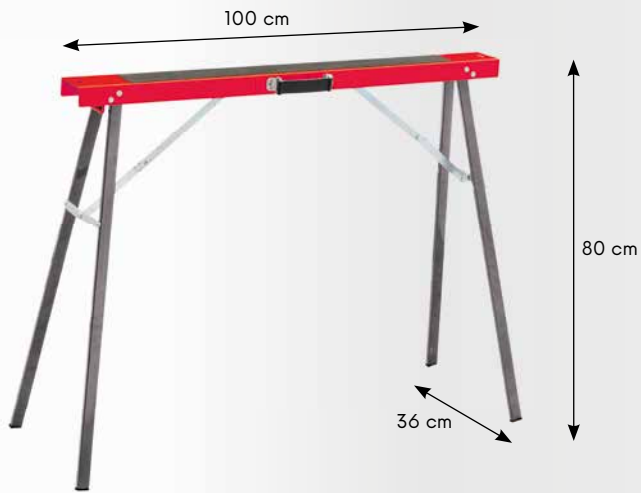

ÁLLÍTHATÓ BAK

· max. terhelés 125 kg

2x		MUNKAPAD	
R.s.	leírás	R.s.	leírás
37549	pár	23655	100 x 50 x 84 cm

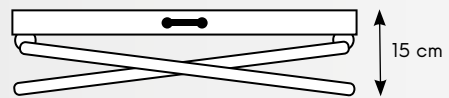

MUNKAPAD

· ideális pincékhez

R.s.	leírás	
23660		1



MUNKAPAD

· max. terhelés: 100 kg

R.s.	leírás	
23650		1



GÖRGŐS ÜLŐKE

· párnázott ülőke műanyag szerszámtartó tálccával

So.	leírás	
26988	360 x 365 x 365 mm	1

FESTA

MÁGNESES SZERSZÁMTARTÓ



R.s.	leírás	
70098		12



**FESTA****SZERSZÁMOS SZEKRÉNY**

So.	Pojezdy zásúvek	Fiókok száma	Teljes méret	
26986	Sima	7	680 x 460 x 1020 mm	1

**SZERSZÁMOS SZEKRÉNY**

A felső szerszámos láda a guruló szekrénybe helyezhető.

So.	leírás	Fiókok csúszása	Fiókok száma	Fiókok belső mérete	Teljes méret	Összsúly	
26985	top case	Sima	3	151,5 x 225 x 40 mm	600 x 260 x 340 mm	11,5 kg	1
			2	511 x 225 x 40 mm			
	bottom case	Sima	1	511 x 225 x 85 mm	616 x 330 x 742 mm	16,4 kg kg	
			2	511 x 308 x 85 mm			

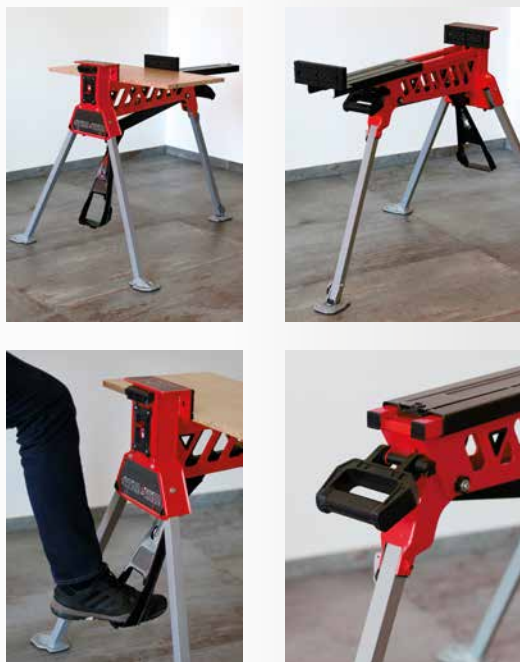

FESTA

HORDOZHATÓ ÁLLVÁNYOS SATU

- tartomány: 0 - 95 cm
- maximális teherbírás: 250 kg



R.sz.	leírás	
37553		1



FESTA

SATU

- edzett szorítópfák

R.sz.	leírás		
23410	100 mm	1	
23411	125 mm	1	
23412	150 mm	1	



SATU FORGATHATÓ

- edzett szorítópfák

R.sz.	leírás		
23415	100 mm	1	
23416	125 mm	1	
23417	150 mm	1	



ASZTALI SATU

R.sz.	leírás	
23407	65 mm	10



GÉPI SATU

- edzett szorítópfák

R.sz.	leírás		
23400	18 80 mm	10	
23401	22 100 mm	10	
23402	24 125 mm	5	



ASZTALI SATU, FORGATHATÓ 360°

ALU	R.sz.	leírás	
	23406	80 mm	24

HIDRAULIKUS EMELŐ

A hosszabbító csavar lehetővé teszi a legalacsonyabb magasságállítást és a maximális emelkedést. Kettős biztonságú szelep. Fogazott nyereg lehetővé teszi a nagy felületű emelést és biztonságos fogást. A széles talp stabilitást és erőt biztosít. Minden modellen a nagy igénybevételnek kitett részek meg vannak erősítve, a tartósság és megbízhatóság érdekében.



So.	terhelhetőség	minimális magasság	emel	Állítsa be a magasságot	alpméreték	súly	
26800	2 000 kg	181mm	116 mm	48 mm	88 x 92 mm	2,6 kg	1
26801	3 000 kg	194 mm	118 mm	60 mm	92 x 100 mm	3,3 kg	1
26802	5 000 kg	216 mm	127 mm	70 mm	96 x 112 mm	4,5 kg	1
26803	8 000 kg	230 mm	147 mm	80 mm	103 x 118 mm	5,7 kg	1
26804	10 000 kg	230 mm	150 mm	80 mm	110 x 123 mm	6,8 kg	1
26805	12 000 kg	230 mm	155 mm	80 mm	116 x 134 mm	7,3 kg	1
26806	15 000 kg	230 mm	150 mm	80 mm	133 x 136 mm	8,4 kg	1
26807	20 000 kg	242 mm	150 mm	60 mm	144 x 152 mm	11 kg	1



KÉT DUGATTYÚS HIDRAULIKUS EMELŐ

A hosszabbító csavar lehetővé teszi a legalacsonyabb magasságállítást és a maximális emelkedést. Kettős biztonságú szelep. Fogazott nyereg lehetővé teszi a nagy felületű emelést és biztonságos fogást. A széles talp stabilitást és erőt biztosít. Minden modellen a nagy igénybevételnek kitett részek meg vannak erősítve, a tartósság és megbízhatóság érdekében.



So.	terhelhetőség	minimális magasság	emel	Állítsa be a magasságot	súly	
26815	2 000 kg	150 mm	160 mm	60 mm	4,7 kg	1
26816	4 000 kg	160 mm	170 mm	60 mm	6,4 kg	1
26817	6 000 kg	215 mm	270 mm	-	8,9 kg	1
26819	10 000 kg	228 mm	284 mm	89 mm	10,2 kg	1



OLLÓS EMELŐ



So.	terhelhetőség	minimális magasság	max. magasság	súly	
26844	1 000 kg	88 mm	380 mm	2,5 kg	1
26845	2 000 kg	120 mm	395 mm	3,5 kg	1



KOCSIS HIDRAULIKUS EMELŐ



So.	leírás	terhelhetőség	minimális magasság	max. magasság	súly	
26820	Kocsis hidraulikus emelő	2 000 kg	130 mm	345 mm	9,6 kg	1
26822	Kocsis hidraulikus emelő	3 000 kg	130 mm	465 mm	27,4 kg	1
26826	Hidraulikus szerviz emelő, alacsony profil, 360°-ban elforgatható kar	2 000 kg	89 mm	359 mm	14,2 kg	1
26824	Hidraulikus szerviz emelő, pedálos	3 000 kg	145 mm	500 mm	37,2 kg	1
26825	Hidraulikus szerviz emelő,	2 500 kg	85 mm	455 mm	34,8 kg	1

KOCSIS HIDRAULIKUS EMEŐ+TARTÓBAK

· 360° - ban elforgatható nyél



So.	terhelhetőség	minimális magasság	max. magasság	súly	
26829	2 000 kg	130 mm	350 mm	10,5 kg	1
	2 000 kg	275 mm	420 mm	5 kg (pair)	

TARTÓBAKOK

1 db=1pár!

Finoman állítható kilincsmű, dupla zárvédelemmel. Tömör acél fogantyú. Egységesített vázszerkezet. Állítható vas állvány.



So.	leírás	terhelhetőség	minimális magasság	max. magasság	súly	
26857	biztosító szeggel	2 000 kg	275 mm	420 mm	4,8 kg	1
26858	biztosító szeggel	3 000 kg	285 mm	425 mm	6,3 kg	1
26859	biztosító szeggel	6 000 kg	393 mm	593 mm	13 kg	1
26853		12 000 kg	465 mm	715 mm	28 kg	1

HIDRAULIKUS KAROS EMEŐDARU

Autóalkatrészek kiemelésére és rögzítésére a beés kiszerelés idejére. A daru gékje helyenként meghosszabbítható. A daru összehajtható, így könnyen tárolható.

So.	terhelhetőség	minimális magasság	max. magasság	súly	
26862	2 000 kg	0	2360 mm	88 kg	1



MOTORTARTÓ

A lengő kar felfüggesztése a kámsza dőlésének függvénye. Mindig kiegyensúlyozott és stabil motorrögzítést biztosít.

So.	terhelhetőség	hossz	hatótávolság	súly	
26871	500 kg	1500 mm	150 mm	20,3 kg	1



HIDRAULIKUS SEBESSÉGVÁLTÓ TARTÓ

Egységek könnyű ki- és beszereléséhez (motorok, sebességváltók, tengelyek, stb.)

So.	leírás	terhelhetőség	hossz	hatótávolság	súly	
26880	Hidraulikus sebességváltó tartó	500 kg	1100 mm	1900 mm	30,0 kg	1



26880

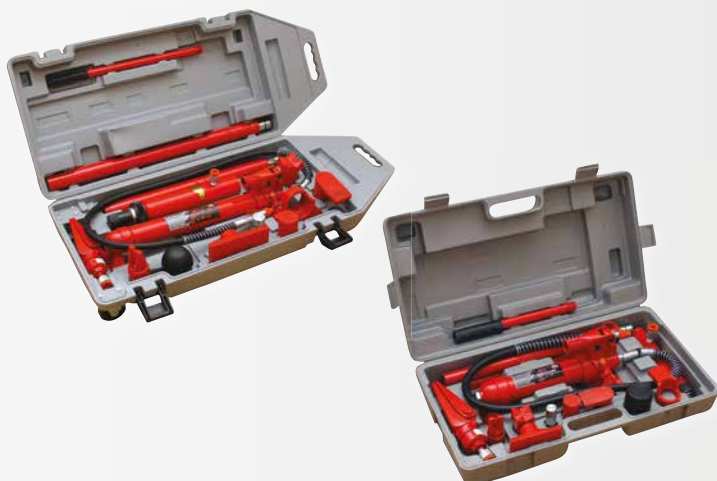

HIDRAULIKUS KAROSSZERIAJAVÍTÓ, HORDOZHATÓ

Hidraulikus berendezés karosszériaajavításhoz. Dugattyús hengerekkel ellátott készülék, 14 tartozékkal. Széles körben alkalmazható személy- és teherautók karosszériájának a javítására, különösen áramellátás nélküli helyszíneken. Vízszintesen és függőlegesen tolató, húzható, emelhető és feszíthető tartozékokkal. Könnyen szállítható az öntött, ütészálló hord táskával.



So.	terhelhetőség	hidraulikus emelő	súly	
26886	4 000 kg	125 mm	17,0 kg	1
26888	10 000 kg	135 mm	32,0 kg	1



MOTORTARTÓ ÁLLVÁNY

Mozgatható állvány motorok szétszereléséhez és javításához. Univerzális befogó egység a motorok rögzítésére és forgatására.



So.	terhelhetőség	súly	
26920	450 kg	20 kg	1



HIDRAULIKUS CSŐHAJLÍTÓ

So.	Kapacitás	Emelési magasság	Hajlító pofa	Súly	
26895	12 000 kg	232 mm	1 2", 3 4", 1", 1-1 4", 1-1 2", 2"	36 kg	1
26896	16 000 kg	238 mm	1 2", 3 4", 1", 1-1 4", 1-1 2", 2", 2-1 2", 3"	65 kg	1



26897

RUGÓ ÖSSZENYOMÓ

26897 - McPherson rugóstagok/rugók járműn kívüli cseréjéhez.

26943 - McPherson rugóstagok/rugók járműn kívüli cseréjéhez. Erős acél profilok a nagyobb stabilitásért.



26943



So.	Terhelhetőség maxima	Ø Összenyomott rugó	Összenyomó hossz	Súly	
26897	1 000 kg	100-200 mm	150 mm	24,5 kg	1
26943	1 000 kg	400 mm	210-570 mm	35 kg	1

FÁRADT OLAJ ELSZÍVÓ

A motorból leeresztett olaj a tölséren keresztül kerül a tartályba. A tartály elszívó berendezéssel van ellátva. A fáradt olaj egy csövön keresztül kiszívható a tartályból.



So.	Terhelhetőség	Max. nyomás	Súly	
26954	90 l	0,5 MPa	28 kg	1



HIDRAULIKUS MŰHELY PRÉS

So.	Hatótávolság	Max.Capacity	Súly	
26940	0 - 610 mm	12 000 kg	43 kg	1
26941	0 - 880 mm	20 000 kg	75 kg	1



HIDRAULIKUS TARTÓS PRÉS



So.	leírás	Terhelhetőség	Min. hossz	Max. magasság	Súly	
26911	egy szivattyú	5 000 kg	620	1100	12 kg	2
26912	egy szivattyú	8 000 kg	620	1100	13 kg	2
26914	dupla szivattyú	5 000 kg	620	1100	12 kg	2
26915	dupla szivattyú	8 000 kg	620	1100	14 kg	2



PÓTALKATRÉSZEK HOMOKFÚVÓ SZEKRÉNY-HEZ

So.	rozméry	
26973	kesztyűt	1
26974	fúvókák	1
26975	fólia 53,5 x 26 cm	1
26976	plexi 60 x 30 cm	1
26977	üveg 60 x 30 cm	1

CSISZOLÓ SZEKRÉNY

So.	Levegőfogyasztás	Külső méret	Belső méret	Max. nyomás	Súly	
26972	420-710 l/min.	1500 x 830 x 630 mm	600 x 840 x 630 mm	8 bar	38 kg	1

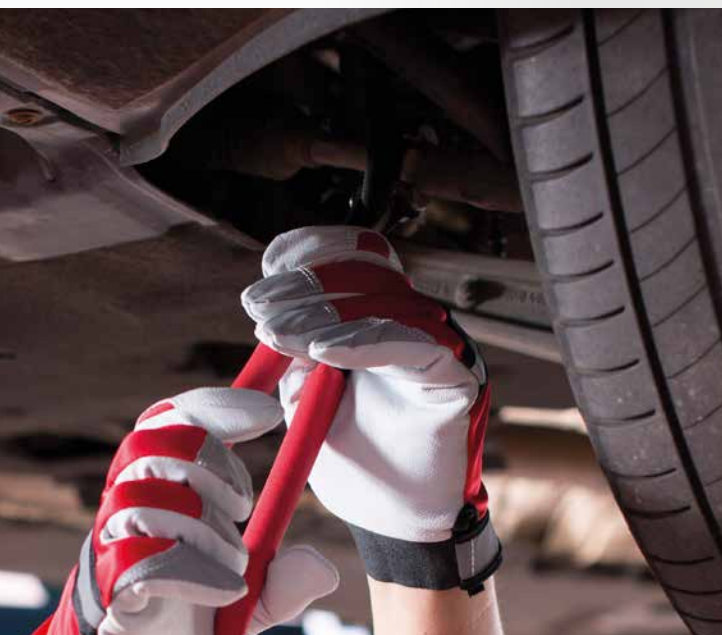

ALKATRÉSZMOSÓ

Általános tárgyak mosására (alkatrészek, tartozékok, stb.).



So.	Tartály Kapacitás	Oldószer Kapacitás	Áramlási sebesség	Max. oldószer hőmérséklet	Súly	
26961	90 l	45 l	10-12 l/min.	50°C	25 kg	1
26963	180l	150 l	20 l/min	50°C	42 kg	1



OLAJZÓKANNA

R.s.	leírás	
50020	300 ml	10



KAROS ZSÍRZÓ

· tölthető nagy mennyiségben vásárolt anyaggal
· patronos töltés
· tölthetőség adagolóval



R.s.	leírás	
50022	400 ml	20

HORDÓPUMPA

R.s.	
50017	10





OLAJOZÓ

R.sz.	leírás	
50019	90 ml	1



SZÜRŐ LESZEDŐ

R.sz.	leírás	
50021	60 x 140 mm	6



TÖLCSÉR

R.sz.	leírás	
50025	60 x 140 mm	50



**ÜZEMANYAGCSŐ
SZELEPPEL**

R.sz.	length	∅	
50026	180 cm	15 mm	24



MÁGNESES TÁLCA



R.sz.	leírás	
26996	200 x 20 mm	1

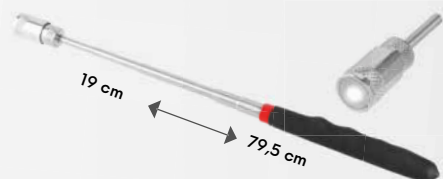

FESTA

**MÁGNESES FELSZEDŐ
TELESZKÓPOS - LED**



R.sz.	leírás	
13294		6

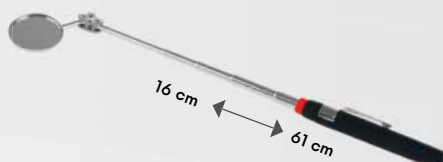

VIZSGÁLÓ TÜKÖR

R.sz.	leírás	
13290		20

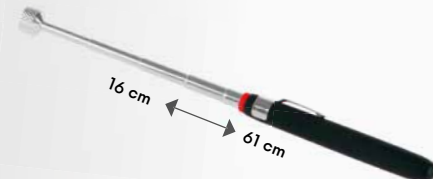

**MÁGNESES FELSZEDŐ
TELESZKÓPOS**



R.sz.	leírás	
13293		20



SZEMÉTFELSZEDŐ

· forgó 90°

R.sz.	length	
61235	81 cm	12

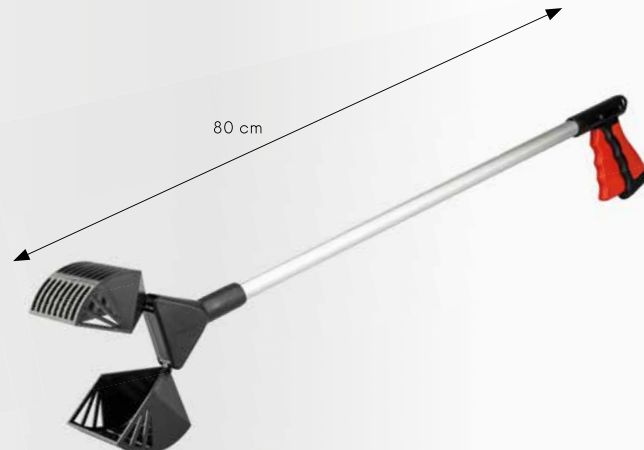

SZEMÉTFELSZEDŐ

· max. 4 kg

R.sz.	
61236	12

FESTA



NEW



80 lm



300 lm



200 lm



158 mm

301 mm

FESTA
INDUSTRY

LED LÁMPA ÖSSZECSUKHATÓ

3xLED	80, 200, 300 lm	3W COB LED	USB TYPE C	Li-ion 3.7V 0.8Ah	120 min
95 g	0-180°	IK07	IP54		

R.sz. **37647** Leírás **3,7V 800 mAh**

1



FESTA

LED LÁMPA



MOQ
12

R.s. leírás
37645 200 mm 3 x AAA 12

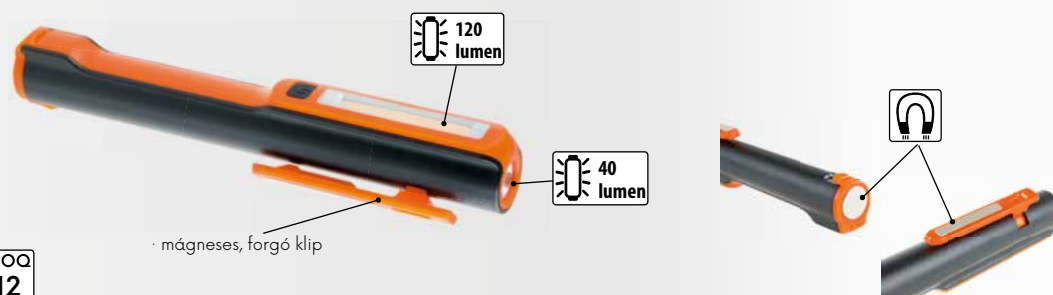

FESTA

FEJLÁMPA, LEDES

súly	47 g
fényforrás	1 x 1 W white LED + 2x red LED
akkumulátor	3 x AAA
méret	40 x 59 x 32 mm
a megvilágítás ideje	45 h
nyílás	120 lumen
a fény hossza	60 m (100% battery)
program száma	4

· 5 pozíciók



R.s. leírás
37641 2 Kétféle fény, fehér és piros 1

FESTA

LED LÁMPA

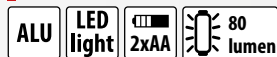

R.s. leírás
37630 185 mm 2 x AA 20



· állítható fogantyú

· fogantyúval



· lágy PVC bevonat

130 lumen



FESTA

LED LÁMPA



R.s. leírás
37650 12

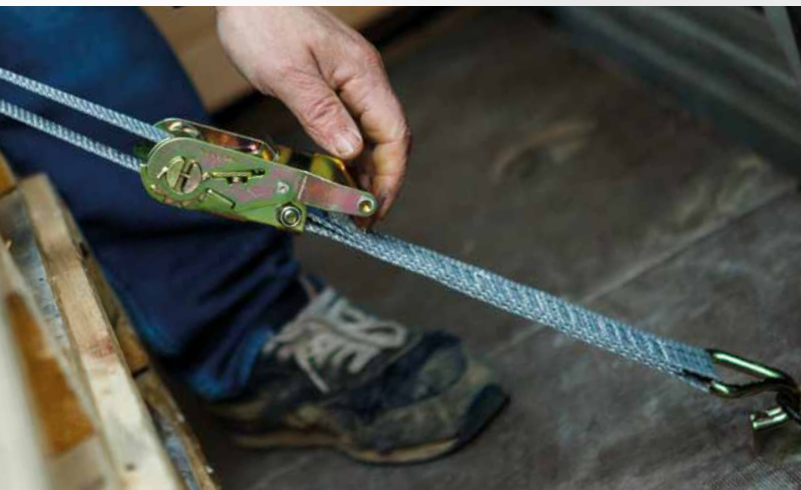

FESTA
SPANIFER



2x



R.s.	width	length	load capacity	db	
51070	18 mm	2 m	100 kg	2	12

FESTA
SPANIFER
CHINGI



R.s.	width	length	load capacity	db	
51071	25 mm	3,5 m	300 kg	1	8



FESTA
SPANIFER



R.s.	width	length	load capacity	db	
51072	35 mm	4 m	500 kg	1	6



FESTA
SPANIFER



R.s.	width	length	load capacity	db	
51040	25 mm	6 m	1000 kg	1	1
51041	35 mm	8 m	2000 kg	1	1
51042	35 mm	8 m	3000 kg	1	1
51043	50 mm	10 m	5000 kg	1	1



FESTA
SPANIFER



2x

R.s.	width	length	load capacity	db	
51060	25 mm	5 m	750 kg	2	5



FESTA
SPANIFER



R.s.	width	length	load capacity	db	
51065	50 mm	10 m	960 kg	1	6



FESTA
SPANIFER



R.s.	width	length	load capacity	db	
51026	75 mm	5 m	3000 kg	1	4



FESTA
SPANIFER



R.s.	width	length	load capacity	db	
51032	25 mm	5 m	500 kg	1	6



FESTA
SPANIFER



R.s.	width	length	load capacity	db	
51017	50 mm	6 m	480 kg	2	5
51018	50 mm	6 m	480 kg	1	10



SPANIFER



R.s.	width	length	leírás	db
51022	25 mm	5 m	horgokkal	40
51023	50 mm	5 m	horgokkal	12

FESTA

SPANIFER



Puha EVA pad

R.s.	width	length	db
51046	38 mm	4 m	1 20

SPANIFER



R.s.	width	length	leírás	db
51030	50 mm	6 m	horgokkal	20
51034	50 mm	8 m	horgokkal	10

SPANIFER



2x

R.s.	width	length	db
51020	25 mm	2,5 m	2 100

SPANIFER



PE

R.s.	width	length	db
51045	25 mm	4 m	1 50

RAKOMÁNYRÖGZÍTŐ ÁLLÍTHATÓ



2x

R.s.	length	Ø	db
51013	1,2 m	8 mm	2 1

RAKOMÁNYRÖGZÍTŐ



2x

R.s.	length	db
51008	1 m	2 25

RAKOMÁNYRÖGZÍTŐ



R.s.	length	Ø	db
51009	1 m	10 mm	1 25

GUMIPÓK KLT.



8x

- 2 x 0,4 m
- 2 x 0,6 m
- 1 x 0,8 m
- 1 x 1,0 m

R.s.	length	Ø	db
51011	1 m	8 mm	8 10

GUMIPÓK



2x

R.s.	length	Ø	db
51001	80 cm	10 mm	2 50
51002	100 cm	10 mm	2 50
51003	150 cm	10 mm	2 50
51004	200 cm	10 mm	2 50

GUMIPÓK



2x

R.s.	length	Ø	db
51007	1 m	8 mm	2 25

GUMIPÓK



R.s.	length	Ø	leírás	db
51010	80 cm	8 mm	8 ágú	50

GUMI HÁLÓ



R.s.	length	width	
51015	80 cm	120 cm	20

GUMIKÖTÉL



R.s.	length	∅	
51036	20 m	8 mm	10
51037	20 m	10 mm	6

GUMIPÓK KAMPÓ



R.s.	∅	
51038	10 mm	30

ALUMÍNIUM KARABINER



R.s.	∅	length	
51200	6 mm	60 mm	2
51202	7 mm	70 mm	2
51201	8 mm	80 mm	2
51203	10 mm	100 mm	2

KÖTÉL



R.s.	length	∅	
50915	5 m	8 mm	1
50916	25 m	8 mm	1
50917	25 m	10 mm	1
50918	25 m	12 mm	1
50919	25 m	14 mm	1

ZSINÓR PE.



R.s.	length	∅	
51055	80 m	1,5 mm	50
51056	50 m	2 mm	50
51057	20 m	4 mm	50



KÖTÉL PE.

R.s.	length	∅	
51050	50 m	8 mm	10
51051	50 m	10 mm	4

MŰANYAGZSINEG



R.s.	tömeg	
50905	80 g	80
50906	100 g	100
50907	200 g	50

MŰANYAGZSINEG



R.s.	tömeg	
50909	500 g (250 m)	1
50910	1000 g (500 m)	1
50911	5000 g (2500 m)	1

KENDERZSINEG



R.s.	tömeg	
50900	80 g (61 m)	1
50901	100 g (76 m)	1
50902	200 g (153 m)	1

VIASZOLT ZSINEG



R.s.	length	∅	
50920	50 m	1 mm	80

RÖGZÍTŐ HUZZAL



R.s.	leírás	
42365	1,25 100 mm	1
42366	1,25 125 mm	1
42367	1,25 140 mm	1
42368	1,25 160 mm	1



HURKOLÓ

R.s.	leírás	
50052		12
50050		1

HURKOLÓ



R.s.	leírás	
50051		2

KÁBELKÖTŐZŐ

50x		EN 50146 nylon	
R.s.	length	width	
23875	120 mm	4,8 mm	1



KÁBELKÖTŐZŐ, SZÍNES

100x		EN 50146 nylon	
R.s.	length	width	
23880	100 mm	2,5 mm	1
23882	150 mm	2,5 mm	1
23884	200 mm	3,6 mm	1



KÁBELKÖTŐZŐ

50x		EN 50146 nylon	
R.s.	length	width	
23850	120 mm	2,5 mm	1
23854	200 mm	3,6 mm	1
23856	250 mm	3,6 mm	1
23858	250 mm	4,8 mm	1
23860	300 mm	4,8 mm	1
23864	400 mm	4,8 mm	1
23866	500 mm	4,8 mm	1
23868	400 mm	7,6 mm	1
23870	500 mm	7,6 mm	1



KÁBELKÖTŐZŐ

50x		EN 50146 nylon	
R.s.	length	width	
23810	120 mm	2,5 mm	1
23814	200 mm	3,6 mm	1
23816	250 mm	3,6 mm	1
23818	250 mm	4,8 mm	1
23820	300 mm	4,8 mm	1
23824	400 mm	4,8 mm	1
23826	500 mm	4,8 mm	1
23828	400 mm	7,6 mm	1
23830	500 mm	7,6 mm	1



KÁBELKÖTŐZŐ OLDHATÓ

10x			
R.s.	length	width	
23865	160 mm	7,5 mm	1



CΣOMAGOLÁSI FOLIA

R.s.	szélesség	hossz	vastagság		
38095	500 mm	600 m	8 μ m	átlátszó	1
38097	100 mm	150 m	20 μ m	átlátszó	1
38096	500 mm	200 m	23 μ m	fekete	1

SITTESZSÁK

R.s.	szélesség	hossz	vastagság	méret	db	
39194	500 mm	1100 mm	0,16 mm	100	1	10
39196	600 mm	1200 mm	0,16 mm	110	1	10
39198	700 mm	1100 mm	0,16 mm	120	1	10
39200	500 mm	1100 mm	0,20 mm	100	1	10
39202	600 mm	1200 mm	0,20 mm	110	1	10
39204	700 mm	1100 mm	0,20 mm	120	1	10

SITTESZSÁK

R.s.	szélesség	hossz	vastagság	méret	db	
39195	500 mm	1100 mm	0,16 mm	100	1	10
39197	600 mm	1200 mm	0,16 mm	110	1	10
39199	700 mm	1100 mm	0,16 mm	120	1	10
39201	500 mm	1100 mm	0,20 mm	100	1	10
39203	600 mm	1200 mm	0,20 mm	110	1	10
39205	700 mm	1100 mm	0,20 mm	120	1	10

SZEMETESZSÁK

R.s.	szélesség	hossz	vastagság	db	
38060	700 mm	1100 mm	0,08 mm	10	1
38063	700 mm	1100 mm	0,10 mm	3	1
38065	700 mm	1100 mm	0,20 mm	3	1

SZEMETESZSÁK

R.s.	szélesség	hossz	vastagság	db	
38050	500 mm	600 mm	0,04 mm	25	1
38052	600 mm	800 mm	0,04 mm	25	1
38054	700 mm	1100 mm	0,04 mm	25	1

SZEMETESZSÁK

5x					
R.s.	szélesség	hossz	vastagság	db	
38055	1200 mm	1000 mm	0,08 mm	5	



KORDON-SZALAG - ERŐVONAL

R.s.	szélesség	hossz	
38955	22 cm	20 m	1
38956	22 cm	50 m	1



KORDON-SZALAG - VÍZ

R.s.	szélesség	hossz	
38957	22 cm	20 m	1
38958	22 cm	50 m	1



KORDON-SZALAG - GÁZ

R.s.	szélesség	hossz	
38959	22 cm	20 m	1
38960	22 cm	50 m	1



KORDON-SZALAG

R.s.	leírás	hossz	
38944	ZÁKAZ VSTUPU, SK	80 mm 250 m	8
38945	VSTUP ZAKÁZÁN, CZ	80 mm 250 m	8



KORDON-SZALAG

R.s.	hossz	
38948	80 mm 250 m	8

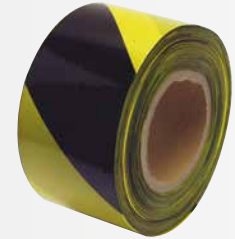

KORDON-SZALAG

R.s.	hossz	
38946	80 mm 250 m	8



KORDON-SZALAG

R.s.	hossz	leírás	
38947	48 mm 33 m	jobb	48
38961	48 mm 33 m	balra	48



JELŐLŐ SZALAG

R.s.	szélesség	hossz	vastagság	
38949	50 mm	50 m	0,15 mm	36

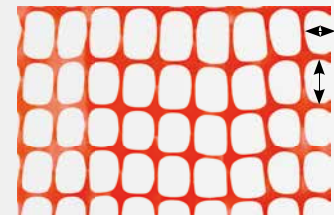

cca 3,5 cm

cca 6,5 cm

BIZTONSÁGI KERÍTÉS

140 g/m² UV STABLE

R.s.	leírás	
42190	1,2 x 50 m HDPE 140g/m ²	1



PVC SZALAG KLT.

5x

R.s.	szélesség	hossz	vastagság	
38931	19 mm	5 m	0,13 mm	100



PVC SZALAG, FEKETE

R.s.	szélesség	hossz	vastagság	
38932	19 mm	10 m	0,13 mm	10



PVC SZALAG

R.s.	szélesség	hossz	vastagság	
38925	19 mm	10 m	0,13 mm	10



PVC SZALAG, FEKETE

R.s.	szélesség	hossz	vastagság	
38968	19 mm	10 m	0,19 mm	10

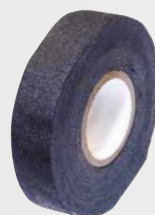

RAGASZTÓ SZALAG, ÜVEGSZÁL ERŐSÍTÉS

R.s.	szélesség	hossz	
38927	19 mm	10 m	10

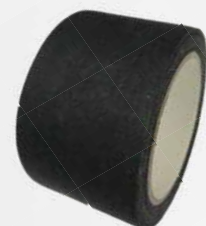

RAGASZTÓ SZALAG, ÜVEGSZÁL ERŐSÍTÉS

R.s.	szélesség	hossz	
38980	48 mm	10 m	24
38981	48 mm	20 m	24



KÉTOLDALAS RAGASZTÓSZALAG, ÁTLÁTSZÓ

R.s.	szélesség	hossz	
38924	50 mm	10 m	1
38964	50 mm	25 m	1



KÉTOLDALAS RAGASZTÓSZALAG

PP

Polypropylen

R.s.	szélesség	hossz	
38929	50 mm	10 m	1
38966	50 mm	25 m	1



KÉTOLDALAS RAGASZTÓSZALAG

MADE IN EU

R.s.	szélesség	hossz	
38990	19 mm	5 m	48
38991	25 mm	5 m	36



RAGASZTÓ SZALAG DUCT

MADE IN EU

R.s.	szélesség	hossz	
38995	48 mm	25 m	24



ALU-TEXTILSZALAG

R.s.	szélesség	hossz	
38965	30 mm	10 m	1
38928	50 mm	10 m	72
38934	50 mm	45 m	24



blue dolphin tapes

RAGASZTÓ SZALAG DUCT

MADE IN EU

R.s.	szélesség	hossz	
37275	48 mm	50 m	24



blue dolphin tapes

KITAKARÓSZALAG

MADE IN EU

R.s.	szélesség	hossz	
37271	38 mm	20 m	24
37270	48 mm	20 m	24
37272	48 mm	50 m	24

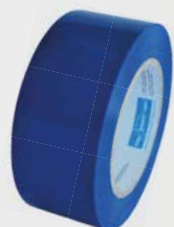

blue dolphin tapes

KITAKARÓSZALAG ABLAKHOZ

MADE IN EU

R.s.	szélesség	hossz	
37273	48 mm	50 m	24



blue dolphin tapes

KITAKARÓSZALAG

MADE IN EU

R.s.	szélesség	hossz	
37263	38 mm	50 m	24
37264	48 mm	50 m	24



PVC KÉTOLDALAS RAGASZTÓSZALAG

MADE IN EU

R.s.	szélesség	hossz	
37266	30 mm	33 m	60
37267	38 mm	33 m	48
37268	50 mm	33 m	36



KREPP SZALAG

MADE IN EU

R.s.	szélesség	hossz	
37255	19 mm	50 m	12
37256	25 mm	50 m	12
37257	30 mm	50 m	7
37258	38 mm	50 m	6
37259	50 mm	50 m	6



PVC SZALAG

MADE IN EU

R.s.	szélesség	hossz	
38942	50 mm	50 m	72



LEMEZES SZALAG



R.s.	szélesség	hossz	
38972	50 mm	50 m	1
38973	50 mm	100 m	1



ALU ÖNTAPADÓ FÓLIA

ALU

R.s.	szélesség	hossz	
38963	48 mm	10 m	1
38943	48 mm	45 m	24



CSÚSZÁSGÁTLÓ SZALAG

R.s.	szélesség	hossz	vastagság	
37280	25 mm	15 m	0,8 mm	72
37281	50 mm	15m	0,8 mm	36



RAGASZTÓ SZALAG

R.s.	szélesség	hossz	
38930	19 mm	5 m	100

ÜVEGSZÁLAS RÁCSOS-
SZALAG, ÖNTAPADÓS

R.s.	szélesség	hossz	
38935	50 mm	20 m	60
38937	50 mm	45 m	36
38939	50 mm	90 m	24
38940	50 mm	153 m	24

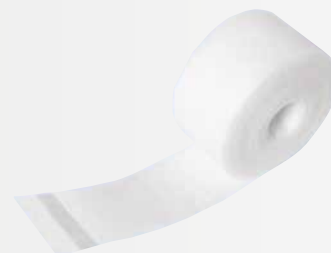

ÜVEGSZÁLAS SZALAG



R.s.	szélesség	hossz	
38941	50 mm	25 m	40



TEFLON SZALAG

R.s.	szélesség	hossz	vastagság	
38969	19 mm	15 m	0,2 mm	10



TEFLON SZALAG

R.s.	szélesség	hossz	vastagság	
38933	12 mm	10 m	0,075 mm	10



TEFLON SZALAG

· víz- és gázberendezésekhez

R.s.	szélesség	hossz	
38926	2 mm	150 m	20

FESTA

MENETTŐ-
MÍTŐ
ZSINÓR

· 160m
· -20°C ... +130°C
· max 16 bar

NEW



R.s.	Leírás	
38975		1



CSOMAGRAGASZTÓ GÉP

R.s.	
38985	1



TÉPŐZÁRAS SZALAG

R.s.	leírás	
45471	12 mm x 5 m	1



FESTA

TÉPŐZÁR SZALAG 3 DB

R.s.	szélesség	hossz	
37295	20 mm	150 mm	1
37296	20 mm	200 mm	1
37297	20 mm	250 mm	1

FESZÍTŐ
CSAVAR

DIN 1480 Zn

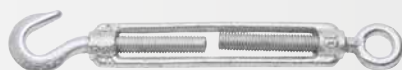

R.s.	leírás	
50100	5 x 70 mm	10
50101	6 x 90 mm	10
50102	8 x 125 mm	10
50103	10 x 150 mm	10

R.s.	leírás	
50104	12 x 200 mm	10
50106	16 x 230 mm	10
50108	20 x 220 mm	10

KARABÍNER

DIN 5299 C Zn



R.s.	leírás	
51204	4 mm	10
51205	5 mm	10
51206	6 mm	10
51207	7 mm	10
51208	8 mm	10

R.s.	leírás	
51209	9 mm	10
51210	10 mm	10
51211	11 mm	10
51212	12 mm	10

MENETES KARABÍNER

Zn



R.s.	leírás	
51241	4 mm	10
51242	5 mm	10
51243	6 mm	10
51244	7 mm	10

R.s.	leírás	
51245	8 mm	10
51246	10 mm	10
51247	12 mm	10

S KAPOCS

Zn



R.s.	leírás	
51271	3 mm	10
51272	4 mm	10
51273	5 mm	10
51274	6 mm	10

R.s.	leírás	
51275	7 mm	10
51276	8 mm	10
51278	10 mm	10

SZEMES ANYA

DIN 5820 Zn



R.s.	leírás	
51320	6 mm	10
51321	8 mm	10
51322	10 mm	10
51323	12 mm	10

R.s.	leírás	
51324	14 mm	10
51325	16 mm	10
51327	20 mm	10

SZEMES CSAVAR

DIN 5820 Zn



R.s.	leírás	
51300	6 mm	10
51301	8 mm	10
51302	10 mm	10
51303	12 mm	10
51304	14 mm	10

R.s.	leírás	
51305	16 mm	10
51306	18 mm	10
51307	20 mm	10
51308	22 mm	10



ALUMÍNIUM KARABÍNER

Zn

R.s.	leírás	
51220	53 mm	10
51221	67 mm	10
51222	76 mm	10



FORGÓ SZEM

Zn

R.s.	leírás	
51225	3,8 mm	10
51226	4,5 mm	10
51227	6,0 mm	10



DRÓTKÖTÉL ÖSSZEKÖTŐ

DIN 5685 C Zn

R.s.	leírás	
51341	Ø 10 mm	10



KÖTÉL BILINCS

Zn

No.	specification	
51280	3 mm	10
51281	5 mm	10
51282	6 mm	10
51283	8 mm	10
51284	10 mm	10
51286	12 mm	10
51287	14 mm	10
51288	16 mm	10



KÖTÉL SZEM

Zn

R.s.	leírás	
51258	Ø 16 mm	10
51259	Ø 18 mm	10
51260	Ø 20 mm	10
51261	Ø 22 mm	10
51262	Ø 24 mm	10
51264	Ø 28 mm	10

LÁNCOS EMELŐCSIGA

So.	Terhelhetőség	Min. magasság	Emelési magasság	Emelőcsigák száma	lánevastagság	Súly	
26700	500 kg	280 mm	3 000 mm	1	6 mm	7,5 kg	1
26701	1 000 kg	300 mm	3 000 mm	1	6 mm	9 kg	1
26702	2 000 kg	380 mm	3 000 mm	2	6 mm	12 kg	1



KÉZI CSÖRLŐ

R.s.	leírás	
50035	2 t	6
50036	4 t	4



RÖVID SZEMŰ LÁNC



DIN 5685 A Zn

R.s.	szem mérete	hossz	
51402	2 x 10 mm	110 m	1
51403	3 x 16 mm	60 m	1
51404	4 x 21 mm	40 m	1
51405	5 x 23 mm	30 m	1



LÁNC VICTOR

DIN 5686 Zn

R.s.	Ø	hossz		R.s.	Ø	hossz	
51430	1,4 mm	150 m	1	51433	2,0 mm	118 m	1
51431	1,6 mm	150 m	1	51435	2,5 mm	70 m	1
51432	1,8 mm	130 m	1	51436	2,8 mm	50 m	1



HOSSZÚ SZEMŰ LÁNC

DIN 5685 C Zn

R.s.	szem mérete	hossz	
51412	2 x 12 mm	80 m	1
51413	3 x 26 mm	60 m	1
51414	4 x 32 mm	38 m	1
51415	5 x 35 mm	32 m	1



LÁNC MŰANYAG



R.s.	leírás	
51450	6 mm 25 m piros fehér	1

CSÖRLŐ
(KÖTÉLLEL
ÉS KAMPOVAL)

Zn

R.s.	noszt	hossz lánca	
26720	300 kg	8 m	1
26705	450 kg	8 m	1
26721	500 kg	8 m	1
26722	800 kg	8 m	1
26706	900 kg	8 m	1
26707	1350 kg	8 m	1



BEMUTATÓ ÁLLVÁNY

R.s.	leírás	
51196	Állvány láncok töltött	10
51197	Állvány kötelekkel töltött	10
51198	Promóciós állvány láncokhoz	10
51199	Promóciós állvány kötelhez	10



ACÉL HUZAL ZN

Zn

R.s.	prűmër lánca	hossz	
51100	Ø 1 mm	500 m	1
51102	Ø 1,5 mm	500 m	1
51103	Ø 2 mm	200 m	1
51104	Ø 3 mm	200 m	1
51105	Ø 4 mm	100 m	1
51106	Ø 5 mm	75 m	1
51107	Ø 6 mm	75 m	1
51130	Ø 8 mm	75 m	1
51131	Ø 10 mm	50 m	1
51132	Ø 12 mm	50 m	1



ACÉL HUZAL PVC

Zn

R.s.	prűmër lánca	hossz	
51108	Ø 2/3 mm	200 m	1
51109	Ø 3/4 mm	100 m	1
51110	Ø 4/5 mm	75 m	1
51111	Ø 5/6 mm	50 m	1

ROZSDAMENTES ACÉL
HUZAL

INOX

R.s.	prűmër lánca	hossz	
51120	Ø 1 mm	300 m	1
51121	Ø 1,2 mm	300 m	1
51122	Ø 1,5 mm	300 m	1
51123	Ø 2 mm	200 m	1
51124	Ø 3 mm	200 m	1
51125	Ø 4 mm	100 m	1
51126	Ø 5 mm	75 m	1
51127	Ø 6 mm	75 m	1





MENETESSZÁR

MENETESSZÁR

DIN 975 Zn

4.8 Szilárdsági osztály

R.sz.	leírás	
55040	M 4 1 m	200
55050	M 5 1 m	150
55060	M 6 1 m	100
55080	M 8 1 m	50
55100	M 10 1 m	20
55120	M 12 1 m	20
55140	M 14 1 m	15
55160	M 16 1 m	15
55180	M 18 1 m	10
55200	M 20 1 m	10
55220	M 22 1 m	5
55240	M 24 1 m	5
55300	M 30 1 m	5

DIN 976 INOX 4.8

Szilárdsági osztály

R.sz.	leírás	
55315	M 12 1 m	20
55316	M 14 1 m	15
55317	M 16 1 m	15
55318	M 18 1 m	10
55319	M 20 1 m	10

előtte utána



MENETESSZÁR

DIN 975 4.8

Szilárdsági osztály

R.sz.	leírás	
55051	M 5 1 m	150
55181	M 18 1 m	10
55201	M 20 1 m	10
55221	M 22 1 m	5

FESTA

ÉLTISZTÍTÓ

Ø 3 - 19 mm

1/4"

R.sz.	leírás	
16321		5



HATLAPÚ ANYA

DIN 934 Zn

4.8 Szilárdsági osztály

R.sz.	leírás	
55350	M 4 100 db	1
55351	M 5 100 db	1
55352	M 6 100 db	1
55353	M 8 100 db	1
55354	M 10 100 db	1
55355	M 12 100 db	1
55356	M 14 100 db	1
55357	M 16 100 db	1
55358	M 18 100 db	1
55359	M 20 10 db	1
55360	M 22 10 db	1
55361	M 24 10 db	1
55362	M 30 10 db	1



ALÁTÉT DIN

DIN 440R Zn



R.sz.	leírás	
55331	M 5 100 db	1
55332	M 6 100 db	1
55333	M 8 100 db	1
55334	M 10 100 db	1
55335	M 12 100 db	1
55336	M 14 100 db	1
55337	M 16 100 db	1
55339	M 20 10 db	1
55340	M 22 10 db	1
55341	M 24 10 db	1
55342	M 30 10 db	1



FESTA

SZERVEZŐ



R.sz.	leírás	
55650	375 x 290 x 67 mm	1



FACSAVAR

2000x

R.sz.	leírás	
55640	2000 db	1



db	
350	3,0 x 16 mm
280	3,0 x 20 mm
220	3,0 x 25 mm
250	3,5 x 20 mm
240	3,5 x 25 mm
180	3,5 x 3, mm
280	4,0 x 16 mm
80	4,0 x 30 mm
40	4,0 x 40 mm
30	4,0 x 50 mm
25	5,0 x 50 mm
25	5,0 x 60 mm

FACSAVAR + TIPLI

csavar fa

db	
40	3,5 x 30 mm
25	4,0 x 40 mm
12	5,0 x 50 mm
8	6,0 x 60 mm

dübel

db	
40	5 x 25 mm
25	6 x 30 mm
12	8 x 40 mm
8	10 x 50 mm

170x

R.sz.	leírás	
55645		1



FACSAVAR

db	
60	3,0 x 12 mm
50	3,0 x 16 mm
40	3,0 x 20 mm
50	3,5 x 20 mm
40	3,5 x 30 mm
25	4,0 x 30 mm
20	4,0 x 40 mm
15	5,0 x 50 mm
10	5,0 x 60 mm

310x

R.sz.	leírás	
55642		1





VÉDŐSZEMÜVEG

CE EN
166

R.s. leírás  10
50510



VÉDŐSZEMÜVEG

CE EN
166

R.s. leírás  10
50514



VÉDŐSZEMÜVEG

Állítható oldalhossz

CE EN
166

R.s. leírás  12
50511



VÉDŐSZEMÜVEG

CE EN
170

R.s. leírás  12
50512 csemne



VÉDŐSZEMÜVEG

CE EN
166

R.s. leírás  1
50513



FÜLTOK

CE EN
352 27
dB

R.s. leírás  1
50563



FÜLTOK

CE EN
352 27
dB

R.s. leírás  1
50564



ARCVÉDŐ PLEXI

CE EN
166

R.s. leírás  10
50556



ARCVÉDŐ

CE
EN 1731

R.s. leírás  10
50562



FÜLDUGÓ

R.s. leírás  100
50560



FÜLDUGÓ

R.s. leírás  100
50559



VÉDŐSISAK CLIMAX

CE EN
397 MADE IN
EU

R.s. leírás  30
50550 kék
50551 piros
50553 fehér
50554 sárga



FÉNYVISSZAVERÓ MELLÉNY

CE EN
20471

R.s. leírás  100
50570 narancs
50571 sárga



TÉRDVÉDŐ PAD, MOBIL

R.s.	leírás	
37135		1

**FESTA**

TÉRDVÉDŐ

R.s.	leírás	
37145	gel	8

**FESTA**

TÉRDVÉDŐ

R.s.	leírás	
37140	gel	12

**FESTA**

TÉRDVÉDŐ

R.s.	leírás	
37144	gel	12

**FESTA**

TÉRDVÉDŐ

R.s.	leírás	
37143		12

**FESTA**

TÉRDVÉDŐ

R.s.	leírás	
37142	komfort	20



TÉRDVÉDŐ

R.s.	leírás	
37139	neopren	10



TÉRDVÉDŐ

R.s.	leírás	
37141		6





VÉDŐKESZTYŰ, ERŐSITETT

· Béléssel a kezdedben



R.s.	leírás	
50518	tméretű 11"	12



VÉDŐKESZTYŰ, ERŐSITETT, BÉLELT TENYÉR

· Béléssel a kezdedben



R.s.	leírás	
50519	tméretű 10,5"	12



HASÍTOTTBŐR KESZTYŰ



R.s.	leírás	
50520	tméretű 10,5"	12



PAMUTKESZTYŰ PVC PÖTTYÖKKEL

R.s.	leírás	
50524	tméretű 10"	12



PAMUTKESZTYŰ TELJESEN MÁRTOTT



R.s.	leírás	
50525	tméretű 10" - hossz 35 cm	12



POLIÉSZTERKESZTYŰ PVC PÖTTYÖKKEL

· PVC pontokkal

R.s.	leírás	
50526	tméretű 10"	12



PAMUTKESZTYŰ FÉLIGMÁRTOTT



R.s.	leírás	
50522	tméretű 10"	12



NYLON KESZTYŰ NITRIL ÁZTATÁS



R.s.	leírás	
50533	tméretű 10"	12



NYLON KESZTYŰ LATEX ÁZTATÁS



R.s.	leírás	
50535	tméretű 8"	12
50536	tméretű 9"	12
50537	tméretű 10"	12



NYLON KESZTYŰ NITRIL ÁZTATÁS

· PVC pontokkal



R.s.	leírás	
50539	tméretű 10"	12



ACRYL TÉLIKESZTYŰ LATEX ERŐSÍTÉS



R.s.	leírás	
50529	tméretű 10"	12



PAMUTKESZTYŰ



R.s.	leírás	
50557	tméretű 7"	12
50558	tméretű 8"	12
50549	tméretű 9"	12



PAMUTKESZTYŰ PVC PÖT- TYÖKKEL KERTÉSZ

* PVC pontokkal

R.sz.	leírás	
50531	tméretű 9"	12



NYLON-KECSKEBŐR KESZTYŰ



R.sz.	leírás	
50541	tméretű 9"	12
50542	tméretű 10"	12



NYLON-DISZNÓBŐR KESZTYŰK



R.sz.	leírás	
50544	tméretű 10"	12



NYLON KESZTYŰ POLIU- RETÁN ÁZTATÁS



R.sz.	leírás	
50527	tméretű 10"	12



HEGESZTŐ KESZTYŰ BŐR



R.sz.	leírás	
50540	tméretű 11"	12



VINYL KESZTYŰ, EGYSZER HASZNÁLATOS

* tiszta, pormentes



R.sz.	leírás	
50532	tméretű 9"	100



PORMASZK



R.sz.	leírás	
50500	FFP2 szelep nélkül	30



PORMASZK



R.sz.	leírás	
50503	FFP2 s ventilem	20

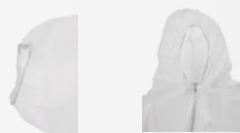

FESTŐ OVERÁL

R.sz.	leírás	
50585	tméretű M	1
50586	tméretű L	1
50587	tméretű XL	1
50588	tméretű XXL	1

KÖTÉNY HEGESZTÉSHEZ



R.sz.	leírás	
50555	bőr	1





FESTA

SZERSZÁMTÁSKA FÉM FOGANTYÚVAL

R.sz.	magasság	hossz	leírás	
37331	280 mm	490 mm	230 mm	2



FESTA

SZERSZÁMTÁSKA

R.sz.	szélesség	magasság	leírás	
37332	480 mm	290 mm	250 mm	1

FESTA

SZERSZÁMTÁSKA

R.sz.	szélesség	magasság	leírás	
37330	610 mm	400 mm	270 mm	5



FESTA

SZERSZÁMTÁSKA

R.sz.	leírás	
37325		10



FESTA

SZERSZÁMTÁSKA

R.sz.	leírás	
37326	Megerősített zsebek	12



FESTA

NYLON ÖV

R.sz.	leírás	
37328	145 cm	20



FESTA
 NYLON ÖV

R.sz.	hossz	szélesség	
37310	120 cm	6 cm	1

FESTA
 SZERSZÁM ÖV

· 14 részes + szem

R.sz.	hossz	szélesség	
37311	120 cm	6 cm	1

FESTA
 SZERSZÁMTOK

· 8 részes

R.sz.	szélesség	magasság	
37320	300 mm	250 mm	1

FESTA
 SZERSZÁMTOK

· 4 részes

R.sz.	szélesség	magasság	
37321	350 mm	300 mm	1

FESTA
 SZERSZÁMMELLÉNY

R.sz.	leírás	
37350		20

FESTA
 ÁCS ÖVTÁSKA

R.sz.	leírás	
37302	6 részes	50
37303	11 részes	25

FESTA
 ÁCS ÖVTÁSKA



R.sz.	leírás	
37300	6 részes	50
37301	11 részes	25

FESTA



BŐRTÁSKA PROFI



R.s.	magasság	hossz	leírás	
37342	270 mm	430 mm	180 mm	1



BŐRTÁSKA VILLANYSZERELŐ



R.s.	magasság	hossz	leírás	
37341	260 mm	430 mm	200 mm	1



BŐRTÁSKA MEGERŐSÍTETT ALJJA



R.s.	magasság	hossz	leírás	
37340	240 mm	430 mm	150 mm	1



TÁSKA PROFI

R.s.	magasság	hossz	leírás	
37344	250 mm	300 mm	130 mm	1



TÁSKA MEGERŐSÍTETT ALJJA

R.s.	magasság	hossz	leírás	
37343	240 mm	430 mm	150 mm	1



TÁSKA VILLANYSZERELŐ

R.s.	magasság	hossz	leírás	
37345	270 mm	430 mm	180 mm	1

ÖVTARTÓ



R.s.	leírás
37308	20



ÖVTARTÓ



R.s.	leírás
37309	20





FESTA

ZÁRBETÉT NIKKELEZETT



R.sz.	leírás	
23001	65 mm · 175 g	10



ZÁRBETÉT NIKKELEL BEVONT



R.sz.	leírás	
23000	65 mm · 75 g	15



FESTA

LAKAT



R.sz.	leírás	
23261	25 mm	6
23262	32 mm	12
23263	38 mm	6
23264	45 mm	6
23265	52 mm	12
23266	63 mm	6



FESTA

ERŐSÍTETT SÁRGARÉZ LAKAT



R.sz.	leírás	
23125	25 mm	12
23130	30 mm	12
23135	35 mm	12
23140	40 mm	12
23150	50 mm	12
23160	60 mm	12



FESTA

SÁRGARÉZ FÜGGŐLAKAT MŰANYAGOZÁSSAL



R.sz.	leírás	
23310	30 mm	10
23311	40 mm	10
23312	50 mm	6



FESTA

LAKAT HOSSZÍTOTT



R.sz.	leírás	
23211	25 mm	12
23212	32 mm	12
23213	38 mm	6
23214	45 mm	6
23215	52 mm	6



FESTA

LAKAT



R.sz.	leírás	
23274	60 mm	6
23275	70 mm	12

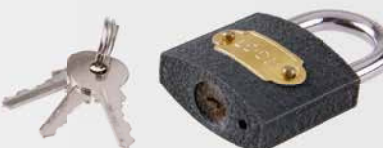

VAS LAKAT



R.sz.	leírás	
23220	25 mm	6
23225	30 mm	6
23232	32 mm	6
23240	40 mm	6
23250	50 mm	6
23260	60 mm	6



SÁRGARÉZ LAKAT



R.sz.	leírás	
23020	20 mm	12
23025	25 mm	12
23030	30 mm	12
23035	35 mm	12
23040	40 mm	12
23050	50 mm	12
23060	60 mm	12





SÁRGARÉZ LAKAT



R.s.	leírás	
23070	40 mm	12

LAKAT



R.s.	leírás	
23010	50 mm	6

LAKAT VÍZBIZTOS



R.s.	leírás	
23005	40 mm	6
23006	50 mm	6



FESTA KEREKPÁR LAKAT

R.s.	leírás	
23288	120 cm x Ø 10 mm	1



FESTA KEREKPÁR LAKAT

R.s.	leírás	
23287	65 cm x Ø 10 mm	1



FESTA KEREKPÁR LAKAT



R.s.	leírás	
23290	120 cm x Ø 8 mm	1
23291	150 cm x Ø 8 mm	1
23292	180 cm x Ø 8 mm	1



KEREKPÁR LAKAT



R.s.	leírás	
23282	55 cm x Ø 8 mm	50
23284	65 cm x Ø 8 mm	50



KEREKPÁR LAKAT

R.s.	leírás	
23281		20





FESTA

**SZÉF
ELEKTRONIKUS ZÁRRAL**



- Zár típusa: elektronikus, mechanikus
- Biztonsági kulcs
- Méretek 350x250x250mm
- Súly 10 kg



R.s.	leírás
23270	

1

FESTA

KULCSJELZŐ

100x



R.s.	leírás
23391	

50

KULCSJELZŐ

100x



R.s.	leírás
23390	

1

CSUKLÓS LAKATPÁNT

R.s.	leírás	leírás
51514	100 mm	25
51515	120 mm	25
51516	140 mm	25
51517	160 mm	25



TOLÓZÁR

R.s.	leírás	leírás
51510	100 mm	12
51511	120 mm	12
51512	140 mm	12
51513	160 mm	12



KULCSSZEKRÉNY

2x

R.s.	leírás	leírás
70140	250 x 180 x 80 mm - 48 kulcs számára	12
70141	300 x 230 x 90 mm - 90 kulcs számára	8

KASSZA

2x



R.s.	width	deep	height	leírás
70120	125 mm	95 mm	60 mm	1

KASSZA

2x



R.s.	width	deep	height	leírás
70121	152 mm	118 mm	80 mm	36

KASSZA

2x



R.s.	width	deep	height	leírás
70122	200 mm	160 mm	90 mm	20

KASSZA

2x



R.s.	width	deep	height	leírás
70123	250 mm	180 mm	90 mm	16



KASSZA



R.s.	width	deep	height	
70124	300 mm	240 mm	90 mm	10



KASSZA



R.s.	width	deep	height	
70125	370 mm	280 mm	90 mm	8



POSTALÁDA



R.s.	color	width	height	deep	
70101	fehér	290 mm	360 mm	105 mm	5
70100	barna	290 mm	360 mm	105 mm	5



POSTALÁDA



R.s.	color	width	height	deep	
70102	fehér	310 mm	260 mm	90 mm	10
70103	barna	310 mm	260 mm	90 mm	10



POSTALÁDA



R.s.	color	width	height	deep	
70105	barna	310 mm	360 mm	90 mm	5



POSTALÁDA



R.s.	color	width	deep	height	
70108	fehér	370 mm	134 mm	364 mm	5



POSTALÁDA



R.s.	width	deep	height		
70107	inox	360 mm	100 mm	520 mm	6



POSTALÁDA



R.s.	width	deep	height		
70106	inox	360 mm	100 mm	360 mm	5



POSTALÁDA



R.s.	width	deep	height		
70109	inox	310 mm	90 mm	260 mm	6



POSTALÁDA



R.s.	width	deep	height		
70110	inox	310 mm	90 mm	360 mm	6

RUGÓSMÉRLEG

R.s.	max.		
24260	50 kg	10	



RUGÓSMÉRLEG

R.s.	max.		
24212	12,5 kg	12	
24225	25 kg	6	
24250	50 kg	6	
24255	100 kg	6	
24258	150 kg	6	



CSIPESZ LEDFÉNNYEL

R.s.	leírás		
50005	95 mm	8	

INOX 3x LR41



CSIPESZ KLT.

R.s.	leírás		
50004		1	

INOX 2x



EGÉRFOGÓ

R.s.	leírás		
70221	90 x 45 mm fa	1	

2x



EGÉRFOGÓ

R.s.	leírás		
70220	97 x 47 mm műanyag	48	

2x



Ø 15 mm



Ø 20mm



LEFOLYÓ TISZTÍTÓ

· fúróval történő használat lehetősége

R.s.	length	Ø	
50014	6 m	6 mm	6



LEFOLYÓ TISZTÍTÓ

R.s.	length		
50010	3 m	10	
50011	5 m	5	
50012	10 m	3	
50013	15 m	4	



Ø 5mm



LEFOLYÓ TISZTÍTÓ

R.s.	length	Ø	
50009	3 m	5 mm	40

LEFOLYÓ-TISZTÍTÓ PUMPA

R.s.	length	Ø	
50015	385 mm	65 mm	30

BEHÚZÓSZALAG

R.s.	length	Ø	
51181	8 m	5 mm	25
51182	10 m	5 mm	25





GLETTVÁS, GITTKÉSEK ÉS KAPARÓK



KŐMŰVES SERPENYŐ



KAPARÓ

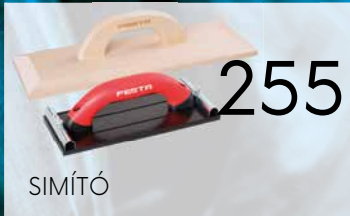

SIMÍTÓ



SIMÍTÓ GIPSKARTONHOZ



KEVERŐK



BETONKEVERŐ



CSÚSZDA ÉPÍTÉSI TÖRMELEKNEK



TALICSKA



HORIZONT ÖLESLÉC



BURKOLAT TÖRŐ

CSEMPEVÁGÓ
KÖRKIVÁGÓVAL

BURKOLÓ SZERSZÁMOK



CSEMPE TÁVTARTÓ



POLISTIROL VÁGÓ

GIPSKARTON
SZERSZÁMOK

ÉGŐ, TÖMLŐ NÉLKÜL



KŐMŰVES VÖDÖR



KINYOMÓPISTOLY

PURHABKINYOMÓ
PISTOLY

FESTŐKÉSZLET



LETAKARÓ PONYVA



LÉTRA



ÁLLÍTHATÓ KELLÉKEK

ÉPÍTKEZÉSI
SZERSZÁMOK

242 - 307





FESTO

FESTO

GLETTVAS
ROZSDAMENTES
280 X 130 MM

gumi fogantyú



R.s.	leírás	
31140	egyenes	10

FESTO

GLETTVAS
ROZSDAMENTES
280 X 130 MM

gumi fogantyú



R.s.	leírás	
31148	egyenes	10

FESTO

GLETTVAS
ROZSDAMENTES
280 X 130 MM

gumi fogantyú



R.s.	leírás	
31146	○ 16	10

FESTO

GLETTVAS
ROZSDAMENTES
280 X 130 MM

gumi fogantyú



R.s.	leírás	
31141	e 4	10
31142	e 6	10
31143	e 8	10

R.s.	leírás	
31144	e 10	10
31145	e 12	10

FESTO

GLETTVAS
ROZSDAMENTES
280 X 130 MM



R.s.	leírás	
31101	e 4	10
31111	e 6	10
31121	e 8	10

R.s.	leírás	
31131	e 10	10
31132	e 12	10

FESTO

GLETTVAS
ROZSDAMENTES
280 X 130 MM



R.s.	leírás	
31091	egyenes	10



FESTA

GLETTVAS
ROZSDAMENTES
280 X 130 MM

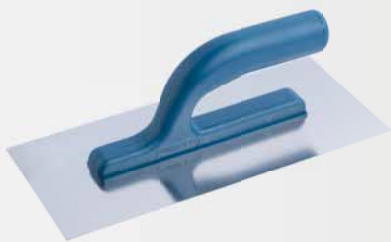

R.s.	leírás	
31011	egyenes	10

FESTA

GLETTVAS
ROZSDAMENTES
280 X 130 MM



R.s.	leírás		R.s.	leírás	
31021	e 4	10	31051	e 10	10
31031	e 6	10	31053	e 12	10
31041	e 8	10			

GLETTVAS
ROZSDAMENTES
270 X 125 MM



R.s.	leírás	
31005	egyenes	25

GLETTVAS
ROZSDAMENTES
270 X 125 MM



R.s.	leírás		R.s.	leírás	
31006	e 4	24	31008	e 8	24
31007	e 6	24	31009	e 10	24

FESTA

GLETTVAS
ROZSDAMENTES
360 X 130 MM



R.s.	leírás	
31151	egyenes	10

FESTA

GLETTVAS
ROZSDAMENTES
360 X 130 MM



R.s.	leírás	
31150	egyenes	10

FESTA

GLETTVAS
ROZSDAMENTES
480 X 130 MM



R.s.	leírás	
31082	egyenes	10

FESTA

GLETTVAS
ROZSDAMENTES
680 X 130 MM



R.s.	leírás	
31155	egyenes	10

FESTA

GLETTVAS
ROZSDAMENTES
500 X 130 MM



R.s.	leírás	
31052	e 4	10
31061	e 6	10
31062	e 8	10
31071	e 10	10
31072	e 12	10

FESTA

GLETTVAS
ROZSDAMENTES
500 X 130 MM



R.s.	leírás	
31081	egyenes	10



FESTA**ROZSDAMENTES
KANÁL****INOX** · gumi fogantyú

R.s.	leírás	
31232	120 mm	10
31233	140 mm	10

**FESTA****ROZSDAMENTES
KANÁL****INOX**

R.s.	leírás	
31220	120 x 80 mm	10
31221	140 x 80 mm	10

**FESTA****ROZSDAMENTES
KANÁL****INOX** · gumi fogantyú

R.s.	leírás	
31334	160 x 100 mm	10

**FESTA****ROZSDAMENTES
KANÁL****INOX**

R.s.	leírás	
31343	160 x 100 mm	10

**FESTA****ROZSDAMENTES
GIPSZELŐ KANÁL****INOX** · gumi fogantyú

R.s.	leírás	
31360	40 mm	10
31380	60 mm	10
31390	80 mm	10

**FESTA****ROZSDAMENTES
GIPSZELŐ KANÁL****INOX**

R.s.	leírás	
31362	40 mm	10
31382	60 mm	10

**FESTA****ROZSDAMENTES
MACSKANYELV KANÁL****INOX** · gumi fogantyú

R.s.	leírás	
31330	140 x 50 mm	10
31340	160 x 60 mm	10

**FESTA****ROZSDAMENTES
MACSKANYELV KANÁL****INOX**

R.s.	leírás	
31332	140 x 50 mm	10
31341	160 x 60 mm	10

**FESTA****BELSŐSAROK KANÁL
ROZSDAMENTES****INOX** · gumi fogantyú

R.s.	leírás	
31280	80 x 60 x 60 mm	10

**FESTA****BELSŐSAROK KANÁL
ROZSDAMENTES****INOX**

R.s.	leírás	
31281	80 x 60 x 60 mm	10

**FESTA****KÜLSŐSAROK KANÁL
ROZSDAMENTES****INOX** · gumi fogantyú

R.s.	leírás	
31270	80 x 60 x 60 mm	10

**FESTA****KÜLSŐSAROK KANÁL
ROZSDAMENTES****INOX**

R.s.	leírás	
31271	80 x 60 x 60 mm	10



FESTA

ROZSDAMENTES BÁDOGOS KANÁL

INOX · gumi fogantyú

R.s.	leírás	
31320	140 x 75 mm	10



FESTA

ROZSDAMENTES BÁDOGOS KANÁL

INOX

R.s.	leírás	
31322	140 x 75 mm	10



FESTA

ROZSDAMENTES KANÁL

INOX

R.s.	leírás	
31218	180 mm e 6	12



FESTA

ROZSDAMENTES SPAKLI

· gumi fogantyú

INOX

R.s.	leírás	
31510	40 mm	10
31511	60 mm	10
31512	80 mm	10



FESTA

KAPARÓ SPAKLI, GUMI NYÉLLEL

· gumi fogantyú
· vastagított penge

INOX

R.s.	leírás	
32173	75 mm	10



FESTA

PADLÓSZÖNYEG KAPARÓ, NYELEZHETŐ

· nyél 52010
· vastagított penge

INOX

R.s.	leírás	
32170	100 mm	12



FESTA

GIPSZKARTON SPAKLI

· gumi fogantyú

INOX

R.s.	leírás	
31455	150 mm	12
31456	200 mm	12

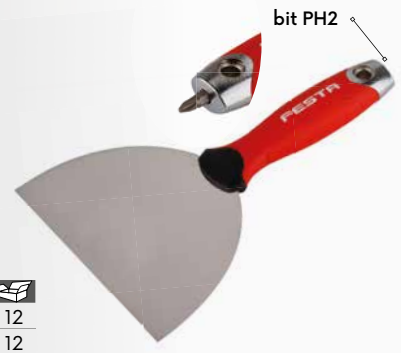

FESTA

ROZSDAMENTES SPAKLI

INOX

R.s.	leírás	
31517		10



FESTA

KAPARÓ RIGIPS

· gumi fogantyú

INOX

R.s.	leírás	
31505	200 mm	5
31506	250 mm	5
31507	300 mm	5



**FESTA****SPAKLI**

· vastagított penge

INOX

R.sz.	szélesség	hossz	
32174	100 mm	500 mm	1

FESTA**ROZSDAMENTES SPAKLI - KAPARÓ****INOX**

R.sz.	leírás	
31461	40 mm	12
31471	60 mm	12
31481	80 mm	12
31491	100 mm	12
31467	120 mm	12
31468	140 mm	12

**FESTA****ROZSDAMENTES SPAKLI****INOX**

R.sz.	leírás	
31498	150 mm	12
31499	200 mm	12
31500	100 mm	12

**ROZSDAMENTES FESTÉKKAPARÓ****INOX**

MADE IN EU

R.sz.	leírás	
31493	40 mm	20
31494	60 mm	20
31495	80 mm	20
31496	100 mm	20

**SPAKLI ACÉL**

R.sz.	leírás	
32176	30 mm	12
32186	40 mm	12
32196	50 mm	12
32206	60 mm	12
32216	80 mm	12
32226	100 mm	12
32234	125 mm	12

**ACÉL SPAKLI
KAPARÓ KÉSZLET****3x**

R.sz.	leírás	
32240	30, 50, 80 mm	10

**FESTA****SPAKLI ACÉL**

R.sz.	leírás		R.sz.	leírás	
32161	30 mm	10	32171	90 mm	10
32162	40 mm	10	32166	100 mm	10
32163	50 mm	10	32172	110 mm	10
32164	60 mm	10	32167	120 mm	10
32169	70 mm	10	32168	140 mm	10
32165	80 mm	10			

**GLETTELŐ HENGER**

- fogantyú 180 mm - 52630
- fogantyú 250 mm - 52625
- hosszú fogantyú 52010, 52011, 52012, 52020, 52030

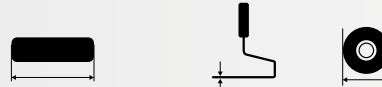

R.sz.	leírás				
52611	250 mm	Ø 8 mm	Ø 48 mm	50	
52612	180 mm	Ø 8 mm	Ø 48 mm	10	

FESTA

GLETTKÉS

INOX

R.sz.	leírás	
31555	35 cm	1
31556	45 cm	1
31557	60 cm	1
31558	80 cm	1
31559	100 cm	1



FESTA

TELESZKÓPOS FOGANTYÚ

menet a 31610-hez, 34203-hoz

R.sz.	leírás	
52011	88 - 140 cm	1

FESTA

GLETTKÉS TARTÓ

· 31555 - 31559 esetén fogantyú 52010, 52011, 52012, 52020, 52030

R.sz.	leírás	
31610		1



ROZSDAMENTES ACÉL SPATULA ERŐSÍTÉSSEL

INOX



R.sz.	leírás	
31520	400 mm	1
31521	500 mm	
31522	600 mm	



fogantyú 61254



31523



31524

ROZSDAMENTES ACÉL SPATULA KIEGÉSZÍTŐK



R.sz.	leírás	
31523	ALU tartó	1
31524	műanyag tartó	1

HOMLOKZATI ROZSDAMENTES SPAKLI

INOX

R.sz.	leírás	
31552	400 mm	10
31553	600 mm	10



HOMLOKZATI ROZSDAMENTES SPAKLI



R.sz.	leírás	
31541	250 mm	1
31551	250 mm keskeny	1



ACÉLSIMÍTÓ

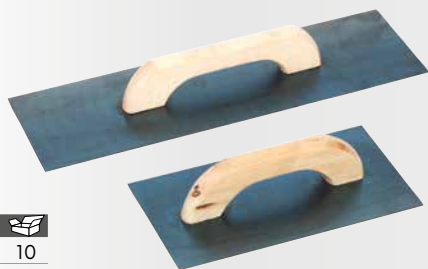

R.sz.	leírás	
32062	280 x 160 mm	10
32060	500 x 140 mm	5

ACÉLSIMÍTÓ
HEGYES

R.sz.	leírás	
32064	500 x 90 mm	5
32066	550 x 140 mm	5

KŐMŰVES
KANÁL
ACÉL

R.sz.	leírás	
32015	160 x 130 mm	10
32014	180 x 130 mm	10
32016	200 x 140 mm	10

KŐMŰVES
KANÁL
ACÉL

R.sz.	leírás	
32001	160 x 110 mm	10
32002	160 x 130 mm	10
32003	180 x 130 mm	10
32013	200 x 140 mm	10

KŐMŰVES KANÁL
ACÉL
GÖMBÖLYŰROTUNJIT

R.sz.	leírás	
32018	160 x 110 mm	10

GIPSZELŐKANÁL
ACÉL

R.sz.	leírás	
32024	140 x 80 mm	12

KŐMŰVES
MACSKANYELV
KANÁL ACÉL

R.sz.	leírás	
32020	140 x 65 mm	12
32021	140 x 40 mm	12

BÁDOGOSKANÁL
ACÉL

R.sz.	leírás	
32026	140 x 85 mm	12

FESTA

KŐMŰVES
SERPENYŐ,
HORGANYZOTT

INOX

R.sz.	leírás	
32285	Ø 180 mm	1

FESTA

KŐMŰVES
SERPENYŐ,
POZINK
MARKOLAT

Zn

R.sz.	leírás	
32265	Ø 180 mm	10

FESTA

KŐMŰVES
SERPENYŐ

R.sz.	leírás	
32273	Ø 160 mm	10
32283	Ø 180 mm	10
32293	Ø 215 mm	10

KŐMŰVES
SERPENYŐ
MŰANYAG

R.sz.	leírás	
32270	Ø 160 mm	1

HABARCSMERŐ

fogantyú 61215

R.s.	leírás	
32302	Ø 180 mm	1
32313	Ø 215 mm	1
32301	Ø 235 mm	1



HABARCSMERŐ,
HORGANYZOTT

fogantyú 61200, 61201

R.s.	leírás	
32268	Ø 215 mm	1
32269	Ø 235 mm	1
32296	Ø 215 mm	1



HABARCSKEVERŐ, NYÉL NÉLKÜL

R.s.	leírás	
60100	fogantyú nélkül 295 x 150 mm	24
61169	fogantyúval 160 cm	3
61218	fogantyú 160 cm	5



HABARCSMERŐ, HORGANYZOTT

MOQ 3

R.s.	leírás	
32295	Ø 180 mm fogantyú 160 cm	3
32297	Ø 215 mm fogantyú 160 cm	3
32298	Ø 235 mm fogantyú 160 cm	3



HORONYMARÓ
YTONGHOZ

R.s.	leírás	
32037	600 mm	1



YTONG
DERÉKSZÖG

R.s.	leírás	
32038	270 x 270 x 270 mm	1



YTONG HABARCSTERÍTŐ
KANÁL

R.s.	leírás	
32089	150 mm	1



FESTA

LAPOSVÉSŐ

CrV	R.s.	leírás	szélesség hrotu	
	19406	300 mm	25 mm	5
	19407	400 mm	30 mm	5



FESTA

SPICCVÉSŐ

CrV	R.s.	leírás	
	19408	250 mm	5
	19409	350 mm	5



FESTA

LAPOSVÉSŐ

CrV	R.s.	leírás	szélesség hrotu	
	19460	300 mm	25 mm	5
	19470	400 mm	30 mm	5



SPICCVÉSŐ

R.s.	leírás	
19400	250 mm	5
19403	350 mm	6



LAPOSVÉSŐ

R.s.	leírás	szélesség hrotu	
19401	250 mm	19 mm	6
19404	350 mm	22 mm	6



LAPOSVÉSŐ

R.s.	leírás	szélesség hrotu	
19402	250 mm	50 mm	2
19405	350 mm	50 mm	6



**FESTA**

ROZSDAMENTES SPAKLI

INOX

R.s.	leírás	
31519	75 mm	10



10

TÖBBFUNKCIÓS
ROZSDAMENTES SPAKLI**INOX**

R.s.	leírás	
31497	63 x 195 mm	12

**FESTA**

KITTKÉS

INOX

R.s.	leírás	
31503	150 mm	12



FESTÉKKAPARÓ

MADE IN
EU

R.s.	leírás	
31501	100 mm	30
31502	pótpenge	1

GIPSZKARTONÓZÓ
SPATULA**PLASTIC**

R.s.	leírás	
34308	50 mm	20
34307	80 mm	12
34306	100 mm	10
34305	150 mm	12

CSISZOLÓTUSKÓ
GYORSRÖGZÍTŐS

R.s.	leírás	
34301	230 x 105 mm	1
34304	235 x 80 mm	1

**FESTA**

CSISZOLÓ TUSKÓ CSAVAROS

R.s.	leírás	
34200	210 x 115 mm	30
34201	240 x 105 mm	50
34202	240 x 80 mm	50

CSISZOLÓ TUSKÓ
NYELEZHETŐ

fogyantú 52030

ALU

R.s.	leírás	
34203	230 x 80 mm aluminium	1
52030	Teleszkopikus rúd	12

CSISZOLÓ
RÁCS
10 DB**10x**

R.s.	leírás	
34271	115 x 290 mm kem. 120	80
34272	115 x 290 mm kem. 100	80
34273	115 x 290 mm kem. 80	80
34274	93 x 290 mm kem. 120	80
34275	93 x 290 mm kem. 100	80
34276	93 x 290 mm kem. 80	80

CSISZOLÓ
RÁCS
3 DB**3x**

R.s.	leírás	
34280	115 x 290 mm kem. 120	20
34281	115 x 290 mm kem. 100	20
34282	115 x 290 mm kem. 80	20
34283	93 x 290 mm kem. 120	20
34284	93 x 290 mm kem. 100	20
34285	93 x 290 mm kem. 80	20





FESTA

JAPÁN SPAKLI KLT.

4x



R.sz.	leírás	
31452	rozsdamentes	50, 80, 100, 120 mm 10
31453	acél	50, 80, 100, 120 mm 10



FESTA

JAPÁN SPAKLI KLT., MÜA.

4x



R.sz.	leírás	
31454		50, 80, 100, 120 mm 12



ACÉL SPATULA

R.sz.	leírás	
31601	180 mm - egyenlő	1
31602	180mm A1	1
31603	180mm A2	1
31641	180 mm - e4	1

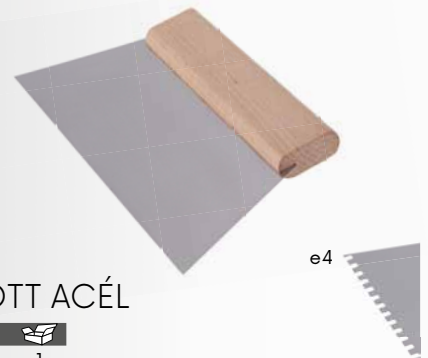

SPATULA FOGAZOTT ACÉL

R.sz.	leírás	
31651	250 mm - sima	1
31655	250 mm - e4	1

MŰANYAG SPATULA



R.sz.	leírás	
37101	125 x 85 mm	100
37111	170 x 115 mm	100



MŰANYAG SPATULA

R.sz.	leírás	
37051	egyenlő	1
37031	fogak - 4 x 6 mm	1
37041	fogak - 6 x 6 mm	1



FUGÁZÓKANÁL ACÉL

R.sz.	leírás	
32022	140 x 80 mm	12
32023	125 x 40 mm	12



FUGÁZÓ KANÁL

R.sz.	leírás	
32040	10 mm	20
32041	12 mm	20
32042	15 mm	20
32043	18 mm	20
32044	20 mm	20



FUGÁZÓ

R.sz.	leírás	
32050	10 12 mm	50
32051	10 15 mm	50
32052	10 18 mm	50
32053	15 20 mm	50



FESTAYTONG
KAPARÓ

nyárfa

R.s. leírás
32317 450 x 95 mm

2

FESTAYTONG KAPARÓ
FINOM FOG

nyárfa

R.s. leírás
32312 450 x 95 mm

2

FESTAYTONG
KAPARÓ

nyárfa

R.s. leírás
32337 260 x 95 mm

2

FESTAYTONG KAPARÓ
FINOM FOG

nyárfa

R.s. leírás
32338 260 x 95 mm

2

**FESTA**

VAKOLATGYALU FA

nyárfa

R.s. leírás
32327 230 x 145 mm

2

YTONG
KAPARÓR.s. leírás
32332 450 x 95 mm

2

VAKOLATGYALU FA

R.s. leírás
32333 230 x 145 mm

2

FESTAKAPARÓ
RÉGI
VAKOLATRAR.s. leírás
32314 400 x 180 mm

2

FESTAKAPARÓ
RÉGI
VAKOLATRAR.s. leírás
32329 270 x 130 mm

2

KAPARÓ
RÉGI
VAKOLATRAR.s. leírás
33168 380 x 160 mm

2

FESTAKAPARÓ
RÉGI
VAKOLATRAR.s. leírás
32320 400 x 180 mm

2

KAPARÓ
RÉGI
VAKOLATRA



MOQ
2

R.sz.	leírás	MOQ
32311	400 x 180 mm	2

FESTA
STYROPOR
CSISZOLÓ
MŰA.



MOQ
2

R.sz.	leírás	MOQ
32324	270 x 130 mm P 16	2
32323	270 x 130 mm P 16 Csiszoló pótlap	10

KAPARÓ
KÖGYAPOTHOZ

Zn

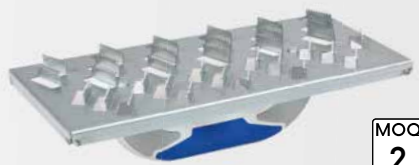

MOQ
2

R.sz.	leírás	MOQ
32328	285 x 145 mm	10

VAKALATGYALU
RÁCSOS

ALU

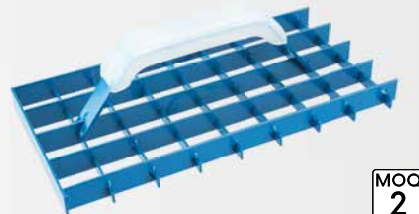

MOQ
2

R.sz.	leírás	MOQ
32316	280 x 150 mm	20

VAKOLATGYALU

· 8 pengevél

ALU

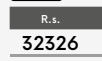

MOQ
2

R.sz.	leírás	MOQ
32326	450 x 90 mm	20

FESTA
MŰANYAG
SIMÍTÓ
ERŐSÍTETT



MOQ
20

R.sz.	leírás	MOQ
34027	400 x 180 mm	20

FESTA
STYROPOR
CSISZOLÓ



R.sz.	leírás	MOQ
32318	400 x 180 mm	2
32319	500 x 250 mm	2
32321	400 x 180 mm P 16 Csiszoló pótlap	10
32322	500 x 250 mm P 16 Csiszoló pótlap	10

FESTA
STYROPOR
CSISZOLÓ
MŰA.



MOQ
2

R.sz.	leírás	MOQ
32330	400 x 180 mm	2
32331	270 x 130 mm	2

FESTA
KAPARÓ



MOQ
2

R.sz.	leírás	MOQ
32325	225 x 105 mm	2

VAKOLATGYALU
RÁCSOS
FOGAZOTT

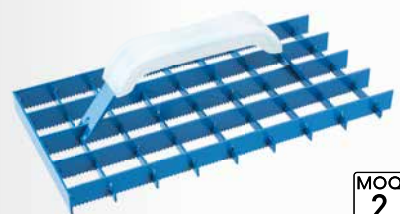

MOQ
2

R.sz.	leírás	MOQ
32335	290 x 145 mm	2

VAKOLATGYALU
MŰANYAG

· 6 pengevél



MOQ
2

R.sz.	leírás	MOQ
32315	270 x 90 mm	30

MŰANYAG
SIMÍTÓ
ERŐSÍTETT



MOQ
20

R.sz.	leírás	MOQ
34028	400 x 180 mm	20

FESTAMŰANYAG
SIMÍTÓ
ABSMADE IN
EU

R.sz.	leírás	
34041	280 x 140 - 2 mm	10
34051	280 x 140 - 3 mm	10
34053	280 x 140 - 3 mm fogak - eó	10

FESTA

SIMÍTÓ



Č.p.	specifikace	
30003	270 x 125 mm	28
30004	235 x 115 mm	35
30005	210 x 115 mm	38
30007	210 x 60 mm	44

FESTA

FA SIMÍTÓ

hársfa



R.sz.	leírás	
34005	400 x 145 mm	40
34007	290 x 145 mm	20

FA SIMÍTÓ

nyárfafa



R.sz.	leírás	
34006	400 x 145 mm	40

PUR
SIMÍTÓMADE IN
EU

R.sz.	leírás		R.sz.	leírás	
34122	120 x 240 mm	50	34154	220 x 420 mm	15
34132	140 x 280 mm	40	34155	240 x 480 mm	15
34142	180 x 320 mm	25	34156	280 x 500 mm	10
34152	200 x 360 mm	20	34157	330 x 330 mm	5
34121	80 x 260 mm lesarkított	50	34158	120 x 800 mm	5
34153	100 x 400 mm	30	34159	120 x 1000 mm	5
			34160	120 x 1200 mm	5

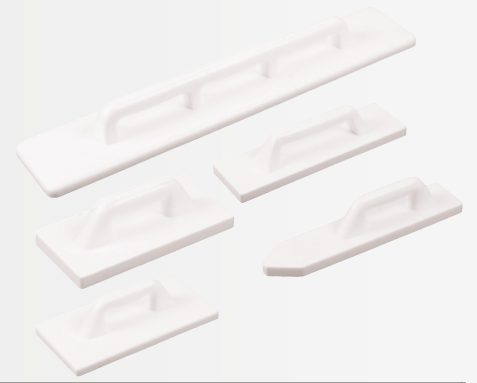
STYROHART
SIMÍTÓMADE IN
EU

R.sz.	leírás	
34101	80 x 350 mm lesarkított	10
34061	130 x 270 mm	10
34111	170 x 320 mm	10
34071	130 x 450 mm	10
34081	140 x 750 mm	10
34091	140 x 900 mm	5

PUR SIMÍTÓ



R.sz.	leírás	
34115	140 x 280 mm	36
34116	180 x 320 mm	36
34117	200 x 360 mm	24

LEHÚZÓLÉC

MADE IN
EU

R.sz.	leírás	
15889	980 x 380 mm nyél Ø 32 mm	1

Ø 23 mm



LEHÚZÓGUMI

R.sz.	leírás	
15886	450 mm nyél Ø 23 mm	48
15887	600 mm nyél Ø 23 mm	48
15888	750 mm nyél Ø 23 mm	32

LEHÚZÓLÉC

MADE IN
EU

R.sz.	leírás	
15885	100 x 800 mm nyél Ø 32 mm	1

ANYAG FELÜLET	BETON		PLASTER				RAGASZTÓK ÉS FUGÁZÓ ANYAGOK	HOMLOKZATI RAGASZTÓ	HASZNÁLATA
	VASTAG	MÁZOLT	FAL VAKOLAT	FINOM BELSŐ	FINOM ÍTONG	FINOM HOMLOKZATI			
FEKETE FILC (BARNA, SZÜRKE)				••••		••			finom vakolat simítása, nagyobb vakolat szemcsékre
FEHÉR FILC				••••	••••	••••			finom vakolat simítása, kisebb vakolat szemcsékre
FINOM HABSZIVACS				••••	••••	••••			szabad homok eltávolítására, finom vakolatra, csempe lemosása fugázás után
DURVA HABSZIVACS				••••	••••	••••			szabad homok eltávolítására, durva vakolatra
RASZTERES HABSZIVACS				••••	••••	••••			szabad homok eltávolítására, raszter segítségével jobban felfogja a durva szemcséket, csempe lemosása fugázás után
TENGERI SZIVACS					•••		••••		fuga anyag lemosása
HYDRO SZIVACS DURVA, FINOM					•		••••		fuga anyag lemosása
SZIVACS				••	••••	••	••••		fuga anyag lemosása, finom vakolat végső tisztítása, vakolat lesimítása
MIKROGUMI							••••		fuga anyag benyomása a fugába
GUMI SZIVACS							••••		fuga anyag benyomása a fugába
MIRELON		••••	•••						beton megmunkálása, durva stukk vakolat megmunkálása
DUREN				••••	••	••••			finom vakolat egyenesítése, általánosan a vakolatok befejezésére
FA	••••	••••	••••						beton megmunkálása, durva stukk vakolat megmunkálása
ACÉL LAP	••	••••		••		••••	••		beton glettelés, elkenése, nehezen elérhető helyek
POLISZTIROL	•••	••••	•••	••		••			beton megmunkálása, durva stukk vakolat megmunkálása
POLYURETAN	••••	••••	••••						beton megmunkálása, durva stukk vakolat megmunkálása
ABS		••		••••	••••	••••	••••		ragasztó, vakolat, stukk vakolat felrakása
SIMA ROZSDAMENTES				••••	••••	••••	••••		ragasztó, vakolat, stukk vakolat felrakása
FOGAS ROZSDAMENTES							••••		ragasztó, vakolat, stukk vakolat felrakása
CSISZOLÓ SIMÍTÓ POLISZTIROLRA, MŰANYAG			••				••••		polisztirol csiszolása, cement ragasztók csiszolása
CSISZOLÓ SIMÍTÓ POLISZTIROLRA, FALAP			••				••••		polisztirol csiszolása, cement ragasztók csiszolása

**FESTA**FEHÉR FILCES
SIMÍTÓ

Č.p.	specifikace	
34400	280 x 140 x 8 mm	15
34415	250 x 130 x 8 mm	15
34450	220 x 130 x 8 mm	15
34445	220 x 70 x 8 mm	20

**FESTA**MŰANYAG
SIMÍTÓ
FEKETE FILCES

Č.p.	specifikace	
34401	280 x 140 x 10 mm	15
34416	250 x 130 x 10 mm	15
34451	220 x 130 x 10 mm	15
34446	220 x 70 x 10 mm	20

**FESTA**SZIVACÓS
SIMÍTÓ

Č.p.	specifikace	
34404	280 x 140 x 30 mm	10
34485	280 x 130 x 20 mm	10
34486	250 x 130 x 30 mm	10
34419	250 x 130 x 20 mm	10
34453	220 x 130 x 20 mm	10
34447	220 x 70 x 20 mm	10

**FESTA**SZIVACÓS
SIMÍTÓ

Č.p.	specifikace	
34405	280 x 140 x 18 mm	15
34420	250 x 130 x 18 mm	15
34454	220 x 130 x 18 mm	15
34449	220 x 70 x 18 mm	20
34480	280 x 140 x 12 mm	15
34481	250 x 130 x 12 mm	15
34482	220 x 130 x 12 mm	15

**FESTA**KEMÉNY SZIVACÓS
SIMÍTÓ

R.sz.	leírás	
34443	280 x 140 x 12 mm	15
34442	250 x 130 x 12 mm	15

**FESTA**KEMÉNY SZIVACÓS
SIMÍTÓ

R.sz.	leírás	
34441	280 x 140 x 12 mm	15
34440	250 x 130 x 12 mm	15
34439	250 x 130 x 18 mm	15



FESTA

SZIVACCSOS SIMÍTÓ
HASÍTOTT



R.sz.	leírás	
34409	280 x 140 x 30 mm	10
34425	250 x 130 x 20 mm	10



FESTA

KEMÉNY SZIVACCSOS
SIMÍTÓ



R.sz.	leírás	
34410	280 x 140 x 30 mm	10
34426	250 x 130 x 20 mm	10



FESTA

TENGERI
SZIVACCSOS
SIMÍTÓ



Č.p.	specifikace	
34406	280 x 140 x 30 mm	10
34421	250 x 130 x 30 mm	10
34455	220 x 130 x 30 mm	10



FESTA

TENGERI SZIVACCSOS
SIMÍTÓ
HASÍTOTT



Č.p.	specifikace	
34413	280 x 140 x 30 mm	10
34428	250 x 130 x 30 mm	10



FESTA

SZIVACCSOS SIMÍTÓ



Č.p.	specifikace	
34412	280 x 140 x 30 mm	10
34424	250 x 130 x 30 mm	10
34458	220 x 130 x 30 mm	10



FESTA

SZIVACCSOS SIMÍTÓ



Č.p.	specifikace	
34490	280 x 140 x 30 mm	10
34491	250 x 130 x 30 mm	10



FESTA

SZIVACCSOS SIMÍTÓ



Č.p.	specifikace	
34411	280 x 140 x 30 mm	10
34423	250 x 130 x 30 mm	10
34457	220 x 130 x 30 mm	10



FESTA

GUMIS SIMÍTÓ



Č.p.	specifikace	
34402	280 x 140 x 10 mm	15
34417	250 x 130 x 10 mm	15
34452	220 x 130 x 10 mm	15



FESTA

MŰANYAG SIMÍTÓ
MIKROGUMIVAL

Č.p.	specifikace	
34403	280 x 140 x 8 mm	15
34418	250 x 130 x 8 mm	15
34496	220 x 130 x 8 mm	15



FESTA

SZIVACCSOS SIMÍTÓ
DUREN



Č.p.	specifikace	
34407	280 x 140 x 20 mm	10
34422	250 x 130 x 20 mm	10
34456	220 x 130 x 20 mm	10
34448	220 x 70 x 20 mm	10

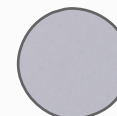

FESTA

SZIVACCSOS
SIMÍTÓ
DUREN



Č.p.	specifikace	
34414	280 x 140 x 20 mm	10
34429	250 x 130 x 20 mm	10



FESTA

SIMÍTÓ

Č.p.	specifikace	
30003	270 x 125 mm	28
30004	235 x 115 mm	35
30005	210 x 115 mm	38
30007	210 x 60 mm	44



FESTAMŰANYAG
SIMÍTÓ
ERŐSÍTETTMADE IN
EU

Č.p.	specifikace	
34033	240 x 95 mm	5

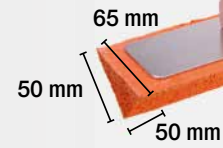
SZIVACOS
SIMÍTÓ
90°

Č.p.	specifikace	
34500	350 mm	6

PÓT FILC

MADE IN
EU

Č.p.	specifikace	
34241	280 x 140 x 8 mm	1
34223	250 x 130 x 8 mm	1

PÓT FILC

MADE IN
EU

Č.p.	specifikace	
34243	280 x 140 x 10 mm	1
34221	250 x 130 x 10 mm	1

PÓTSZIVACS

MADE IN
EU

Č.p.	specifikace	
34262	280 x 140 x 18 mm	1

PÓT SZIVACS

MADE IN
EU

Č.p.	specifikace	
34251	280 x 140 x 30 mm	1

PÓT SZIVACS

MADE IN
EU

R.s.	leírás	
34261	280 x 140 x 30 mm	1

PÓT TENGERI
SZIVACSMADE IN
EU

R.s.	leírás	
34265	280 x 140 x 30 mm	1

PÓTSZIVACS

MADE IN
EU

R.s.	leírás	
34238	280 x 140 x 30 mm	1

PÓTSZIVACS

MADE IN
EU

R.s.	leírás	
34237	280 x 140 x 30 mm	1
34235	250 x 130 x 30 mm	1

PÓTGUMI

MADE IN
EU

R.s.	leírás	
34231	280 x 140 x 10 mm	1



FESTA**ELEKTROMOS
HABARCSKEVERŐ DUPLA**

Bemenet	1800 W
Feszültség / frekvencia	230 V / 50 Hz
Fogaskerekek	2
1. fokozat (alapjárat sebesség)	0 - 450 ot./min.
2. fokozat (alapjárat sebesség)	0 - 790 ot./min.
Túltöltés elleni védelem	Igen
Keverőkosár átmérője	100 mm
Seprű hossza	570 mm
Súly	5,6 kg



R.sz.	leírás	
35311	keverő	1
35318	tartalék szén	1
35319	tartalék keverők - pár (L + R)	1

**FESTA****ELEKTROMOS HABARCS ÉS FESTÉKKEVERŐ 1600W**

Teljesítmény:	1600 W
Hálózati feszültség:	230 V 50 Hz
Fokozatok száma:	2
1. Üresjárat fordulatszám:	0 - 480 ot./min.
2. Üresjárat fordulatszám:	0 - 800 ot./min.
Védelem:	Igen
Cérna:	M 14
Keverőlapát:	140 mm
Keverőlapát hossza:	600 mm
Tömeg:	4,7 kg

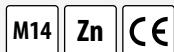

R.sz.	leírás	
35310		1
35317	tartalék szén	1

**FESTA****ELEKTROMOS HABARCS ÉS FESTÉKKEVERŐ 850W**

Teljesítmény:	850 W
Hálózati feszültség:	230 V 50 Hz
Fokozatok száma:	1
1. Üresjárat fordulatszám:	0 - 500 ot./min.
2. Üresjárat fordulatszám:	-
Védelem:	Igen
Cérna:	M 14
Keverőlapát:	120 mm
Keverőlapát hossza:	600 mm
Tömeg:	3,7 kg

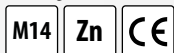

R.sz.	leírás	
35300		1
35316	tartalék szén	1



**WEST
BERG****ELEKTROMOS HABARCS ÉS FESTÉKKEVERŐ 1600W**

Teljesítmény:	1600 W
Hálózati feszültség:	230 V / 50 Hz
Fokozatok száma:	2
1. Üresjáratú fordulatszám:	180 - 400 ot./min.
2. Üresjáratú fordulatszám:	300 - 700 ot./min.
Védelem:	Igen
Cérna:	M 14
Keverőlapát:	140 mm
Keverőlapát hossza:	600 mm
Tömeg:	5,4 kg

M14 Zn CE

R.sz.	Leírás	
35305		1
35315	tartalék szén	1

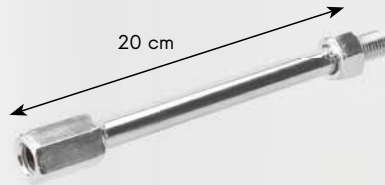
**NEW****FESTA****HOSSZABBÍTÓ****M14**

R.sz.	Leírás	
35142	M14	1

**NEW****FESTA****HABARCS KEVERŐSZÁR**

Bal kezés, órajárással ellentétes- nagy terjedelmű cementhabarcs keverésére.

Zn	M14	R.sz.	Leírás		
		35085	M14 Ø 120 x 600 mm	12	
		35086	M14 Ø 140 x 600 mm	12	
		35087	M14 Ø 160 x 600 mm	12	

**FESTA****HABARCS KEVERŐSZÁR**

Spiral mixer: -jobb kezés- nehezen keverhető anyagokhoz. Vakolóanyagok, mésztartalmú vakolatok, beton és bitumenes kötőanyagok keverésére.

Zn	M14	R.sz.	Leírás		
		35091	M14 Ø 120 x 600 mm	12	
		35092	M14 Ø 140 x 600 mm	12	
		35093	M14 Ø 160 x 600 mm	12	

**FESTA****KEVERŐSZÁR KÖRREL HORGANYZOTT**

Habarcsok, készvakolatok, csemperagasztók, glett anyagok keverésére.

	Zn	R.sz.	Leírás	
		35038	Ø 80 x 500 mm	24
		35058	Ø 100 x 500 mm	24
		35023	Ø 120 x 500 mm	24



FESTA**HABARCS KEVERŐSZÁR**

Habarcok, készvakolatok, csempereasztók, glett anyagok keverésére.

SDS+	Zn	R.sz.	leírás	
		35094	Ø 80 x 500 mm	24
		35095	Ø 100 x 500 mm	24
		35096	Ø 120 x 500 mm	24



**FESTA****HABARCS KEVERŐSZÁR**

Habarcok, készvakolatok, csempereasztók, glett anyagok keverésére.

M14	Zn	R.sz.	leírás	
		35059	M14 Ø 90 x 550 mm	24



**FESTA****KEVERŐSZÁR HORGANYZOTT**

Habarcok, készvakolatok, csempereasztók, glett anyagok keverésére.

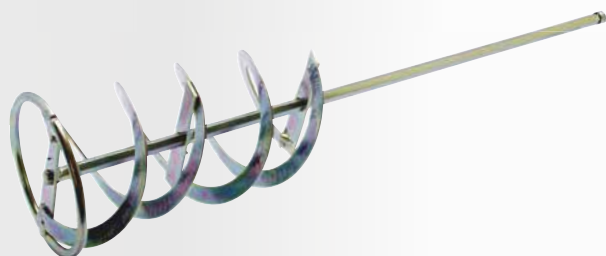
	Zn	R.sz.	leírás	
		35013	Ø 80 x 500 mm	24
		35006	Ø 100 x 500 mm	24
		35007	Ø 120 x 500 mm	24



**FESTA****KEVERŐSZÁR HORGANYZOTT**

Habarcok, készvakolatok, csempereasztók, glett anyagok keverésére.

SDS+	Zn	R.sz.	leírás		
		35012	Ø 100 x 500 mm	24	

**FESTA****HABARCS KEVERŐSZÁR**

Habarcok, készvakolatok, csempereasztók, glett anyagok keverésére.

	Zn	R.sz.	leírás	
		35069	Ø 60 x 500 mm	50
		35078	Ø 80 x 500 mm	24
		35081	Ø 100 x 500 mm	24

**FESTA****HABARCS KEVERŐSZÁR**

Habarcok, készvakolatok, csempereasztók, glett anyagok keverésére.

SDS+	Zn	R.sz.	leírás	
		35070	Ø 60 x 500 mm	50
		35079	Ø 80 x 500 mm	24
		35082	Ø 100 x 500 mm	24



FESTA**KEVERŐSZÁR KÖR NÉLKÜL HORGANYZOTT**

Habarcatok, készvakolatok, csemperagasztók, glett anyagok keverésére.

R.sz.	leírás	
35048	Ø 70 x 500 mm	24
35068	Ø 90 x 500 mm	24

**FESTA****KEVERŐSZÁR HORGANYZOTT**

Habarcatok, készvakolatok, csemperagasztók, glett anyagok keverésére.

R.sz.	leírás	
35021	Ø 90 x 500 mm	24

**FESTA****KEVERŐSZÁR, KALITKÁS, HORGANYZOTT**

glettanyagok, tömítőanyagok, ragasztók, habarcatok keverésére

R.sz.	leírás	
35015	Ø 100 x 500 mm	20

**FESTA****KEVERŐSZÁR KÉT PROPELLERREL HORGANYZOTT**

folyékony anyagok, festékek, tapéta és csemperagasztók keverésére.

R.sz.	leírás	
35011	Ø 80 x 500 mm	50

**KEVERŐSZÁR**

Mindenfajta falfesték és diszperziós festék, ragasztók, beton, esztrich, cement keverésére.

R.sz.	leírás	
35125	Ø 60 x 400 mm	40
35126	Ø 80 x 400 mm	40
35127	Ø 100 x 600 mm	20

**KEVERŐSZÁR - FESTETT**

Mindenfajta falfesték és diszperziós festék, ragasztók, beton, esztrich, cement keverésére.

R.sz.	leírás	
35103	Ø 60 x 400 mm	40
35113	Ø 80 x 400 mm	40
35123	Ø 100 x 600 mm	20



FESTA





PROFI BETONKEVERŐK

Lescha

Profi igényeket kielégítő betonkeverők
 Öntöttvas hajtó fogaskoszorú rögzítéssel
 Pórszóró felületek
 DIN EN ISO 9000-nak megfelelő minőség biztosítás
 Speciális formájú keverődob
 IP 45 splash biztos védelem
 220 V és 380 V-s meghajtás

Lescha BETONKEVERŐ



R.sz.	leírás	
35500	Star 150 - 125 l, 230 V fék	1



Lescha BETONKEVERŐ



R.sz.	leírás	
35502	EUROMIX 125 l, 230 V	1
35503	EUROMIX 125 l, 400 V	1



Lescha BETONKEVERŐ



R.sz.	leírás	
35501	BX 135 - 125 l, 230 V	1



Lescha BETONKEVERŐ



R.sz.	leírás	
35504	ABM 135 l, 230 V fék	1



Lescha BETONKEVERŐ



R.sz.	leírás	
35505	SM 145 S - 140 l, 230 V	1
35506	SM 145 S - 140 l, 400 V	1
35507	SM 145 S - 140 l, 230 V fék	1
35508	SM 145 S - 140 l, 400 V fék	1



Lescha BETONKEVERŐ



R.sz.	leírás	
35510	SM 165 S - 160 l, 230 V fék	1
35511	SM 165 S - 160 l, 400 V fék	1
35512	SM 165 S - 160 l, G benzin	1



Lescha BETONKEVERŐ



R.sz.	leírás	
35514	SM 185 S - 180 l, 230 V fék	1
35515	SM 185 S - 180 l, 400 V fék	1



Lescha BETONKEVERŐ



R.sz.	leírás	
35516	S 180 HR - 180 l, 230 V fék	1
35517	S 180 HR - 180 l, 400 V fék	1



Lescha BETONKEVERŐ



R.sz.	leírás	
35524	LB 354 230 V, 1,5 kW	1
35525	LB 354 400 V, 1,5 kW	1
35527	LB 354 Honda G200	1
35532	LB 404 230 V, 1,5 kW	1
35533	LB 404 400 V, 1,5 kW	1
35539	LB 484 Robin EH17B	1
35540	LB 484 Honda GX160LX	1
35542	AT 480 400 V, 1,2 kW	1

Lescha BETONKEVERŐ



R.sz.	leírás	
35552	LHB 1000 400 V	1
35553	LHB 1000 HATZ Diesel	1
35555	LHB 1200 400 V	1

ALTRAD BETONKEVERŐ



R.sz.	leírás	
37500	MIX 130Zk 230 V szét szerelt	1
37501	MIX 130Z 230 V összeszerelt	1
37505	MK 165Bk 230 V szét szerelt	1
37506	MK 165B 230 V összeszerelt	1

Lescha BETONKEVERŐ



R.sz.	leírás	
35518	S 230 HR - 230 l, 230 V fék	1
35519	S 230 HR - 230 l, 400 V fék	1



130 L

leírás

a dob térfogata	130 l
dob sebesség	26±Min ⁻¹
erő	700 W
feszültség	230 V / 50 Hz
a védelem mértéke	IP44
Koszorú anyaga	lotinóv
méreték	hossz 1170 mm lätíme 650 mm magasság 1280 mm
súly	53 kg

165 L

leírás

a dob térfogata	165 l
dob sebesség	23±Min ⁻¹
erő	900 W
feszültség	230 V / 50 Hz
a védelem mértéke	IP44
Koszorú anyaga	lotinóv
méreték	hossz 1295 mm lätíme 735 mm magasság 1440 mm
súly	70 kg

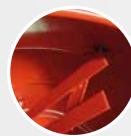

- Speciálisan kialakított lapátok, 4 mm-es vastagság



- Minőségi lábtartó fedéllel



- Kapcsoló biztonsági fedéllel



- Meghajtó műanyag fedéllel, öntöttvas koszorú

BETONKEVERŐ



125 L

leírás	
a dob térfogata	125 l
dob sebesség	26±Min ⁻¹
erő	550 W
feszültség	230 V / 50 Hz
a védelem mértéke	IP44
Koszorú anyaga	lotinóv
méretek	hossz 1102 mm lätíme 690 mm magasság 1310 mm
súly	52,5 kg

R.sz.	leírás		
37509	126 l, 230 V	összeszerelt	1
37510	126 l, 230 V	szétszerelt	1

162 L

leírás	
a dob térfogata	162 l
dob sebesség	26±Min ⁻¹
erő	650 W
feszültség	230 V / 50 Hz
a védelem mértéke	IP44
Koszorú anyaga	lotinóv cast iron
méretek	hossz lungime 1180 mm lätíme szélesség 710 mm magasság/ inaltíme 1310 mm
súly	56 kg

R.sz.	leírás		
37515	162 l, 230 V	szétszerelt	1
37516	162 l, 230 V	összeszerelt	1



TALICSKA



R.sz.	leírás		
37530	60 l, Ø 38 cm	tömör gumi	1
37532	60 l, Ø 40 cm	fúvott gumi	1

142 L

leírás	
a dob térfogata	142 l
dob sebesség	26±Min ⁻¹
erő	650 W
feszültség	230 V / 50 Hz
a védelem mértéke	IP44
Koszorú anyaga	lotinóv
méretek	hossz 1164 mm lätíme 690 mm magasság 1293 mm
súly	54 kg

R.sz.	leírás		
37511	142 l, 230 V	szétszerelt	1
37512	142 l, 230 V	összeszerelt	1

180 L

leírás	
a dob térfogata	180 l
dob sebesség	26±Min ⁻¹
erő	850 W
feszültség	230 V / 50 Hz
a védelem mértéke	IP44
Koszorú anyaga	lotinóv cast iron
méretek	hossz lungime 1164 mm lätíme szélesség 690 mm magasság/ inaltíme 1368 mm
súly	58 kg

R.sz.	leírás		
37517	180 l, 230 V	szétszerelt	1
37518	180 l, 230 V	összeszerelt	1



TALICSKA, HORGANYZOTT



R.sz.	leírás		
37527	80 l, Ø 40 cm	fúvott gumi	1
37533	80 l, Ø 38 cm	tömör gumi	1

TALICSKA
PUTTONY



R.sz.	leírás	
37539	60 l	1

TALICSKA
PUTTONY,
HORGANYZOTT



R.sz.	leírás	
37541	80 l	1

PÓTKERÉK



R.sz.	leírás	
48729	typ AA 400	fúvott gumi
48730	typ AA 380	tömör gumibroncs
48731	typ AA 380	tömör gumibroncs (Slovakia)



HÁROM
KEREKŰ
TALICSKA



R.sz.	leírás	
37564	60 l	1

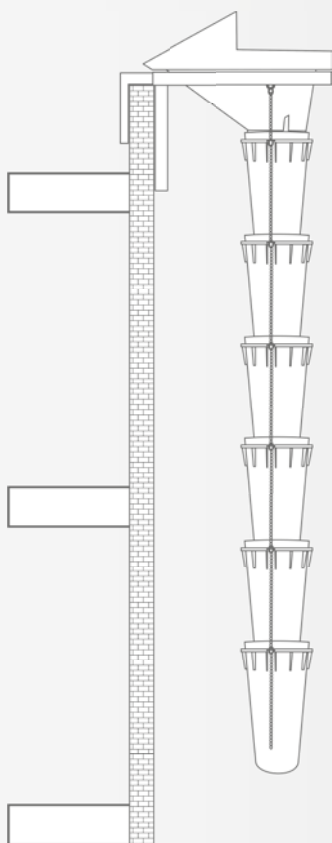

Lescha

ICSÚSZDA ÉPÍTÉSI TÖRMELEKNEK



R.sz.	leírás	
35603	csepp alapátmérő 50/40 cm, hossza 108 cm PE (HDPE)	1
35604	PE építési törmelék (HDPE)	1
35605	tartókeret az építési törmelék garatkonformitása érdekében	1

HORIZONT®



HORIZONT®

ÖLESLÉC

ALU

So.	leírás	
15310	100 cm	10
15315	150 cm	10
15318	180 cm	10
15320	200 cm	10
15325	250 cm	10
15330	300 cm	10
15335	350 cm	10
15340	400 cm	10



HORIZONT®

ÖLESLÉC 1 LIBELLÁS

ALU

So.	leírás	
15415	150 cm	10
15418	180 cm	10
15420	200 cm	10
15425	250 cm	10
15430	300 cm	10



HORIZONT®

ÖLESLÉC 2 LIBELLÁS

ALU

So.	leírás	
15510	100 cm	10
15515	150 cm	10
15518	180 cm	10
15520	200 cm	10
15525	250 cm	10
15530	300 cm	10
15535	350 cm	10
15540	400 cm	5



HORIZONT®

ÖLESLÉC 2 FOGANTYÚS

ALU

So.	leírás	
15615	150 cm	10
15620	200 cm	10
15625	250 cm	10
15630	300 cm	10

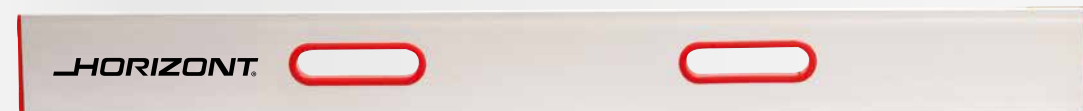

HORIZONT®

ÖLESLÉC 2 LIBELLÁS

ALU

So.	leírás	
15710	100 cm	10
15715	150 cm	10
15720	200 cm	10
15725	250 cm	10
15730	300 cm	10
15735	350 cm	10
15740	400 cm	5





HORIZONT. LEHÚZÓLÉC, TRAPÉZ ALAKÚ

TRAPÉZ ALAKÚ PROFI

- A trapéz alakú profil finomabb felületkezeléshez használható
- Stukkókra és homlokzatra alkalmas
- Vékonyrétegű vakolatokhoz alkalmas

ALU	So.	leírás	
	15810	100 cm	10
	15812	120 cm	10
	15815	150 cm	10
	15818	180 cm	10
	15820	200 cm	10
	15825	250 cm	10
	15830	300 cm	10



HORIZONT. LEHÚZÓLÉC, H ALAKÚ

"h" profil

- "H" profil finomabb felületkezelésre szolgál
- Stukkókra és homlokzatokra alkalmas
- Stukkó mennyezetre alkalmas

ALU	So.	leírás	
	15850	100 cm	10
	15853	150 cm	10
	15855	180 cm	10
	15860	200 cm	10
	15870	250 cm	10
	15880	300 cm	10

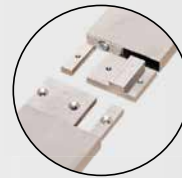

NEW

HORIZONT. ÖLESLÉC HORIZONT CSATLAKOZÓ RÉSZ

So.	leírás		
15301		1	



HORIZONT. ÖLESLÉC 1 LIBELLÁS ÁLLÍTHATÓ

So.	leírás		
15893	65 - 100 cm	1	
15894	95 - 150 cm	1	
15895	145 - 235 cm	1	



HORIZONT. DERÉKSZÖG

ALU	So.	leírás	
	14485	800 x 1200 mm	1
	14486	1000 x 1500 mm	1





FESTA

RÚDHAJLÍTÓ

R.s.	Leírás	
26730	Ø 6 - 14 mm	1
26731	Ø 5 - 8 mm	1



27 - 45 cm

NEW

FESTA

TÉRKŐ FOGÓ

R.s.	Leírás	
60130	27 - 45 cm	10

NEW



200-300 mm

FESTA

TÉRKŐ KIEMELŐ

R.s.	Leírás	
60132		1

NEW

FESTA

TÉRKŐ SZÁLLÍTÓ KOCSI

· max 150 kg



50-110 cm

R.s.	Leírás	
60157		1



RÚDHAJLÍTÓ

R.s.	Leírás	
26735	max Ø 13 mm 56 cm	1

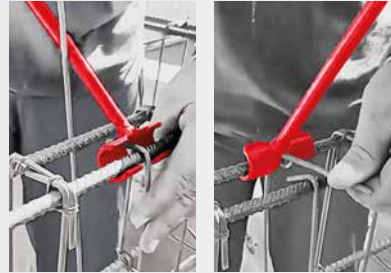

NEW

RÚDHAJLÍTÓ

· Ø 4-8 mm

R.s.	Leírás	
26736		1



NEW

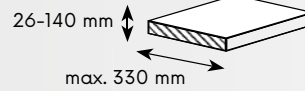

FESTA

TÉRKŐVÁGÓ

· max 45 kg

R.s.	Leírás	
60125		1



NEW

FESTA

TÉRKŐ SZÁLLÍTÓ KOCSI

· max 100 kg



35-60 cm

R.s.	Leírás	
60155		1



30 - 50 cm

PADLÓCSEMPE TARTÓ

R.sz.	leírás	
36310	max. 20kg	5



SZEGÉLY HORDOZÓ

R.sz.	leírás	
60116	PRO 041	1



SOR EGYENGETŐ KALAPÁCS

R.sz.	leírás	
60121	870 mm	1
60123	450 mm	1



SZEGÉLY HORDOZÓ

R.sz.	leírás	
60115	PRO 040	1



SZEGÉLY HORDOZÓ

R.sz.	leírás	
60117	PRO 042	1
60118	PRO 043	1



BURKOLAT ALÁTÉTT

R.sz.	leírás	
37166	D10 basic	25



KÖTÉLCSIGA Z 500

R.sz.	leírás	
26780	0,5 t A horoggal	1
26781	0,5 t B szem	1
26782	0,5 t C horoggal és védővel	1
26783	0,5 t D védővel	1

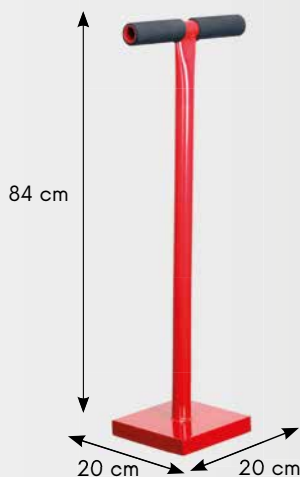

KÉZI DÖNGÖLŐ

R.sz.	leírás	
26740	12 kg	1



MOLNÁRKOCSI

R.sz.	leírás	noszt	
48719	kerék 260 mm bantam	250 kg	1



PROFI CSEMPEVÁGÓ

- Legigényesebb profi csempevágó.
- A mozgítás 9 STK golyóscsapággal történik
- A mozgástér behatárolása végett ebből négy állítható.
- Alárugózott (lökés csillapított) asztal.
- Pót alkatrészek és szervíz biztosított.
- Króm-wolfrám acélos vágókerekek.



SUPER PRO



CSEMPEVÁGÓ SUPER PRO "EVO"

· 36195 Tartalék vágó kerék - Ø 22 mm



R.sz. leírás
36191 1250 mm



1

SUPER PRO



CSEMPEVÁGÓ

· 36195 Tartalék vágó kerék - Ø 22 mm



R.sz.	leírás	
36145	SUPER PRO 450 mm	1
36160	SUPER PRO 600 mm	1
36175	SUPER PRO 750 mm	1
36190	SUPER PRO 900 mm	1



1



· illustrative photo

BEMUTATÓ ÁLLVÁNY SUPER PRO



R.sz.	leírás	
36200	állvány	1
36199	állni a étel 36160, 36175, 36190	1



FESTA

CSEMPEVÁGÓ "X"

· 36138 Tartalék vágó kerék - Ø 22 mm



R.sz.	leírás	
36085	600 mm	1
36087	900 mm	1
36086	1300 mm	1



NEW



FESTA

CSEMPEVÁGÓ

· 36139 Tartalék vágó kerék - Ø 22 mm



R.sz.	leírás	
36102	1050 mm	1
36103	1300 mm	1
36105	1550 mm	1

FESTA

CSEMPEVÁGÓ

· 36195 Tartalék vágó kerék - Ø 22 mm



R.sz.	leírás	
36080	600 mm	1
36081	750 mm	1
36082	900 mm	1
36076	750 mm összeszerelt	1
36077	900 mm összeszerelt	1



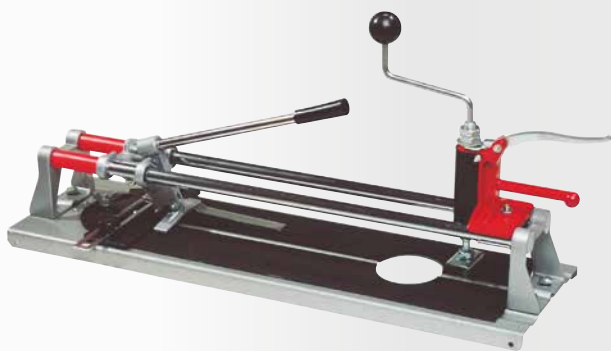

CSEMPEVÁGÓ KÖRKIVÁGÓVAL

• 36128 Tartalék vágó kerék - Ø 16 mm



R.sz.	leírás	
36014	480 mm	4

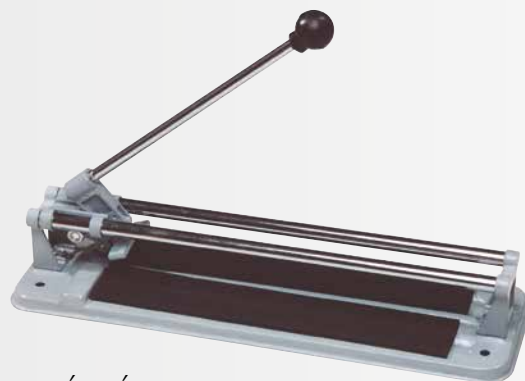

CSEMPEVÁGÓ

• 36126 Tartalék vágó kerék - Ø 15 mm



R.sz.	leírás	
36024	300 mm	10
36034	400 mm	10
36035	600 mm	4



CSEMPEVÁGÓ

• 36136 Tartalék vágó kerék - Ø 22 mm



R.sz.	leírás	
36036	480 mm	1

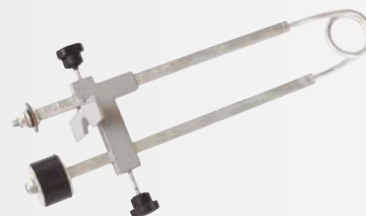

KÉZI CSEMPEVÁGÓ

• 36136 Tartalék vágó kerék - Ø 22,2 mm



R.sz.	leírás	
36046	22 mm	1



FESTA

SPECIÁLIS ADAPTER BURKOLÓLAPOK, 45° FOKBAN TÖRTÉNŐ GÉRVÁGÁSÁHOZ

A készlet tartalma:

- vezetősín
- szivattyú vízűtéshez
- tartalék tömlő vízűtéshez
- szállítótáska

R.sz.	leírás	
24680		1



TARTALÉK VÁGÓ KERÉK



Broj	specifikacija	
36126	a= Ø 15 mm, b= Ø 6 mm, c= 1,5 mm	1
36128	a= Ø 16 mm, b= Ø 6 mm, c= 3 mm	1
36130	a= Ø 20 mm, b= Ø 6 mm, c= 5 mm	1
36136	a= Ø 22 mm, b= Ø 6 mm, c= 2 mm	1
36138	a= Ø 22 mm, b= Ø 6 mm, c= 5 mm	1
36139	a= Ø 22 mm, b= Ø 6 mm, c= 6 mm	1
36195	a= Ø 22 mm, b= Ø 6 mm, c= 4,8 mm	1



SZÚRÓFŰRÉSZ LAP KERÁMIÁHOZ, BOSCH

R.sz.	leírás	
24055	Karbid - BOSCH, MAKITA	1



FESTA

CSEMPEFOGÓ



R.sz.	leírás	
36057	200 mm	6



CSEMPE (VÁGÓ-LETÖRŐ) FOGÓ

R.sz.	leírás	
36056		10



CSEMPE (VÁGÓ-LETÖRŐ) FOGÓ

R.sz.	leírás	
36059		1



CSEMPECSÍPÓ FOGÓ

R.sz.	leírás	
36058	200 mm	6



FESTA

LAMINÁT LAP VÁGÓ



R.sz.	leírás	
36140	210 mm	4



NEW



FESTA

SZILIKON FUGAKIHÚZÓ 5in1



R.sz.	leírás
37050	

1



FESTA

SZILIKON FUGAKIHÚZÓ



R.sz.	leírás
16056	145 mm

50

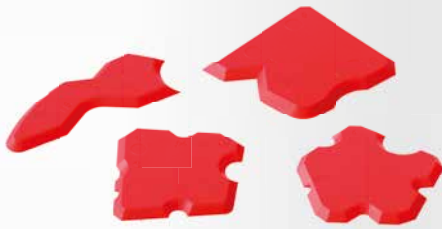

SZILIKON FUGAKIHÚZÓ

4x



R.sz.	leírás
37052	

1



SZILIKON FUGAKIHÚZÓ

4x



R.sz.	leírás
37053	

48



SZILIKON FUGAKIHÚZÓ

R.sz.	leírás
37054	

1



SZILIKON FUGAKIHÚZÓ

for joining of windows

R.sz.	leírás
37055	

1



FUGÁZÓ GUMI

R.sz.	leírás
37011	180 mm
37021	280 mm

12

12



37028



37029

SZIVACSKOCKA 160 X 110 X 60 MM

R.sz.	leírás
37028	szivacsos
37029	tengeri szivacsokocka

1

1



37025



37026

SZIVACSKOCKA 200 X 100 X 100 MM

R.sz.	leírás
37025	finom szivacsokocka
37026	tengeri szivacsokocka

1

1



BURKOLÓ VÖDÖR

R.sz.	leírás
37117	klt
90070	vödör 25 l

1

1

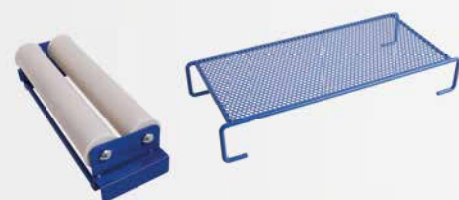

RÁCS, LEHÚZÓ HENGEREK

R.sz.	leírás
90072	rács
90071	lehúzó hengerek

1

1

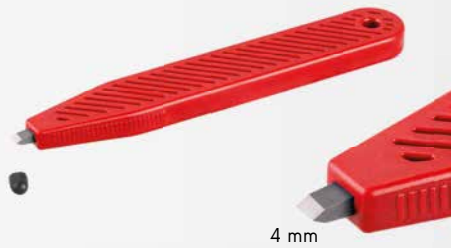

4 mm

FUGA TISZTÍTÓ



R.sz.	leírás	
37012		1



37006

37007

FUGA TISZTÍTÓ



R.sz.	leírás	
37006	30 mm	20
37007	50 mm	20
37008	tartalék penge 30 mm	50
37009	tartalék penge 50 mm	50



FUGA ELTÁVOLÍTÓ KLT.

3x

R.sz.	leírás	
16042		12

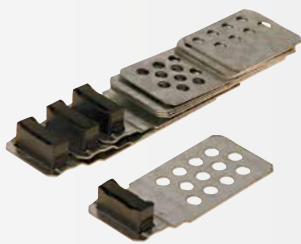

CSEMPEMÁGNES



4x



R.sz.	leírás	
38920		1



CSEMPEMÁGNES, ÁLLÍTHATÓ



4x



R.sz.	leírás	
38923		24

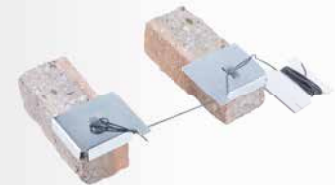

ÉPÍTÉSI SAROK KLT.

R.sz.	leírás	
38919		50



FUGÁZÓ PISZTOLY

objem 1,5 l



R.sz.	leírás	
38026	5x tip	25



FUGA KINYOMÓ TASAK



R.sz.	leírás	
38042	3x tip	6

NEW

- Ø 10 mm
- Ø 14 mm
- Ø 20 mm
- Ø 10 x 35 mm

FESTA

GÉPI CSIGÁS FUGÁZÓ

4x tip

R.sz.	leírás	
38045		1





PARKETTÁZÓ KLT.

24x

R.s.	leírás	db
52130		1



MŰA. ÉKEK

50x

R.s.	leírás	db
37210	95 x 45 x 15 - 0 mm	50
37211	70 x 30 x 8 - 0 mm	50



FELFÚJHATÓ ÉK

· méret 15x17 cm
· max. magasság . 5 cm

R.s.	leírás	db
37220		1

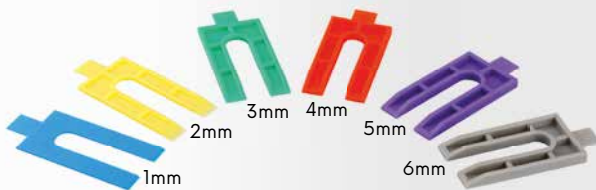

TÁVTARTÓK

30x

R.s.	leírás	db
37212	1 - 6 mm, 5x bármilyen méretű	1

FESTA

FA ÉKEK



R.s.	leírás	db
37204	55 x 20 x 0 - 6 mm	20
37203	65 x 18 x 0 - 12 mm	20
37202	80 x 25 x 3 - 10 mm	20
37201	100 x 25 x 1 - 16 mm	14
37200	150 x 25 x 1 - 25 mm	8

FESTA

MŰANYAG CSEMPEÉK

R.s.	leírás	db
37155	0 - 8 mm	30
37156	0 - 4 mm	100
37157	2,5 - 8 mm	30



FESTA

MŰANYAG CSEMPEÉK

250x

R.s.	leírás	db
37205	55 x 8 x 0 - 10 mm	250



NEW

NIVELYS
LEVELING SYSTEMSZINTEZŐ PROFIL
FALBURKOLATHOZ

ALU

R.s.	leírás	db
37105	50 cm	1
37106	100 cm	1
37107	150 cm	1



NEW

NIVELYS
LEVELING SYSTEMÁLLÍTHATÓ LÁBAK
SZINTEZŐ
PROFILHOZ

· max. 50 kg

2x

R.s.	leírás	db
37102		1

NIVELYS

LEVELING SYSTEMS

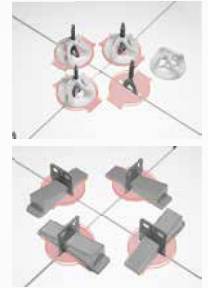

NIVELYS
LEVELING SYSTEMS FESTA

MENETES TÁVTARTÓ KAPCS

50x

R.s.	leírás	db
37131	1 mm	40
37132	2 mm	40

NIVELYS
LEVELING SYSTEMS FESTA

SZINTEZŐ KALAP

50x

R.s.	leírás	db
37130		15

NIVELYS
LEVELING SYSTEMS FESTA

VÉDŐLAPOK CSEMKE SZINTEZŐ RENDSZEREKHEZ

100x

R.s.	leírás	db
37192		1

NIVELYS
LEVELING SYSTEMS FESTA

TÁVTARTÓ KAPU

kiegénylítő ékek 37175, 37176

50x

R.s.	leírás	db
37170	1 mm	50
37171	2 mm	50
37172	3 mm	50

NIVELYS
LEVELING SYSTEMS FESTA

TÁVTARTÓ KAPU

100x

R.s.	leírás	db
37185	1 mm	100
37190	1,5 mm	100
37186	2 mm	100
37187	3 mm	100
37188	4 mm	100
37189	5 mm	100

NIVELYS
LEVELING SYSTEMS FESTA

TÁVTARTÓ KAPU

100x

R.s.	leírás	db
37162	1,5 mm	1

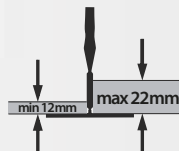

NIVELYS
LEVELING SYSTEMS FESTA

KIEGÉNYLÍTŐ ÉKEK

R.s.	db
37175	50
37176	400

NIVELYS
LEVELING SYSTEMS FESTA



NIVELYS
LEVELING SYSTEMS **FESTA**

TÁVTARTÓ KAPU

600x

R.s.	leírás	db	krabice	
37125	1 mm	600	38 x 28 x 19 cm	1
37126	1,5 mm	600	38 x 28 x 19 cm	1
37127	2 mm	600	38 x 28 x 19 cm	1



NIVELYS
LEVELING SYSTEMS **FESTA**

TÁVTARTÓ KAPU + KIEGYENLÍTŐ ÉK

R.s.	leírás	db	
37173	1 mm,	400 db + 200 db	1
37174	1,5 mm,	400 db + 200 db	1



NIVELYS
LEVELING SYSTEMS **FESTA**

SZINTEZŐ FOGÓ

R.s.	
37177	1



NIVELYS
LEVELING SYSTEMS **FESTA**

SZINTEZŐ FOGÓ

R.s.	
37178	1



CSEMPE SZINTEZŐ KÉSZLET

50x

R.s.	leírás	
37199	1,5 mm	40



NIVELYS
LEVELING SYSTEMS **FESTA**

MŰANYAG FUGAKERESZT

100x

R.s.	leírás	db	
37195	1,0 mm	100	12
37196	1,5 mm	100	12
37197	2 mm	100	12
37198	3 mm	100	12



FESTA

MŰANYAG FUGAKERESZT

R.s.	leírás	db	
37148	1,0 mm	200	100
37149	1,5 mm	200	100
37150	2 mm	200	100
37151	2,5 mm	200	100
37152	3 mm	150	100
37153	4 mm	100	100
37154	5 mm	75	100
37158	10 mm	30	100



FESTA

MŰANYAG FUGAKERESZT

100x

R.s.	leírás	
37285	1,5 mm	100
37286	2 mm	100
37287	2,5 mm	100
37288	3 mm	100
37289	4 mm	100

NEW

vízszintes helyzetben
110 kg

függőleges helyzet
80 kg

Ø 220 mm

USB-C



FESTA
POWER X TOOLS

ELEKTROMOS TAPADÓKORONG

Ø 220 mm	80kg	110kg	ROUGH SURFACE	USB-C	Li-ion 3.6V 2Ah
----------	------	-------	---------------	-------	--------------------

R.s. Leírás

36326



FESTA

VÁKUMOS SZÍVÓKORONG

Ø 200 mm	140kg	100kg	ROUGH SURFACE
----------	-------	-------	---------------

R.s. Leírás

36325

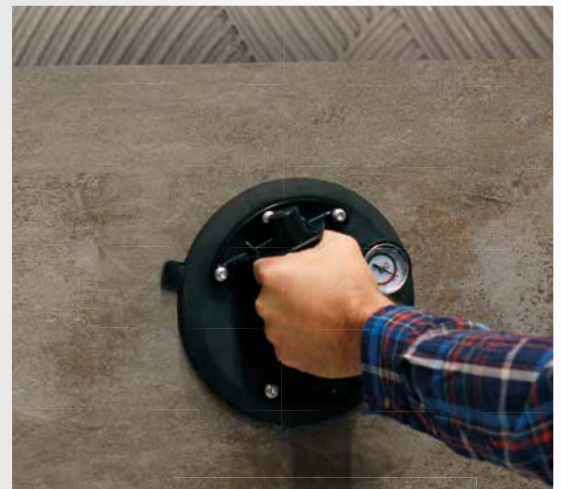

FESTA

ÜVEGTÁBLA FOGÓ

pozíció	max. Betöltés
vízszintes helyzetben	120 kg
függőleges helyzet	150 kg

ALU

R.s. leírás
36318 triple



FESTA

ÜVEGTÁBLA FOGÓ

pozíció	max. Betöltés
vízszintes helyzetben	80 kg
függőleges helyzet	100 kg

ALU

R.s. leírás
36313 double



FESTA

ÜVEGTÁBLA FOGÓ

pozíció	max. Betöltés
vízszintes helyzetben	50 kg
függőleges helyzet	50 kg

ALU

R.s. leírás
36314 single



ÜVEGTÁBLA FOGÓ

R.s. leírás
36305 single

60



ÜVEGTÁBLA FOGÓ

R.s. leírás
36306 double

20



ÜVEGTÁBLA FOGÓ

pozíció	max. Betöltés
vízszintes helyzetben	80 kg
függőleges helyzet	100 kg

R.s. leírás
36319 triple

10



**FESTA**

KICSAPÓ ZSINÓR 30 M + FESTÉK POR 120 G

· 6x gyorsabb tekerő mechanika
· függőn funkció



R.s.

37070

6

**FESTA**

KICSAPÓ ZSINÓR KLT. 150 G

· 5x gyors csévézés



R.s.

37065

6



KICSAPÓZSINÓR KLT. 180 G



R.s.

37069

10



KICSAPÓZSINÓR - MŰANYAG



R.s.

37066

25



KICSAPÓZSINÓR

ALU

R.s.

37068

25



KICSAPÓZSINÓR MŰANYAG ABS



R.s.

37067

25

**FESTA**

PORFESTÉK 180 G

R.s.	leírás	📦
37096	kék	10
37094	fény kék	10
37097	piros	10
37095	fény piros	10
37098	fekete	10

**FESTA**

KŐMŰVES ZSINÓR PIROS



R.s.

38895 50 m

24

38896 100 m

24

**FESTA**

KŐMŰVES ZSINÓR SÁRGA



R.s.

38899 50 m

24

38900 100 m

24

**FESTA**

KŐMŰVES ZSINÓR 50 M



R.s.

38907 piros, 1,0 mm

100

38908 piros, 1,7 mm

100

38909 piros, 2,0 mm

100



FESTA

**KŐMŰVES ZSINÓR
50 M**

R.sz.	leírás	
38904	sárga 1,0 mm	100
38905	sárga 1,7 mm	100
38906	sárga 2,0 mm	100



FESTA

**KŐMŰVES ZSINÓR
50 M**

R.sz.	leírás	
38910	narancs 1,0 mm	100
38911	narancs 1,7 mm	100
38912	narancs 2,0 mm	100



FESTA

**KŐMŰVES ZSINÓR
50 M**

R.sz.	leírás	
38901	fehér 1,0 mm	100
38902	fehér 1,7 mm	100
38903	fehér 2,0 mm	100



VIASZOLT ZSINEG



R.sz.	hossz	Ø	
50920	50 m	1 mm	80



FESTA

**FÜGGŐÓN - ZSINÓRRAL
15 M**



R.sz.	leírás	
38916	150 g	10
38917	300 g	6
38918	500 g	5



FESTA

FÜGGŐÓN



R.sz.	leírás	
38913	150 g	10
38914	300 g	10
38915	500 g	10

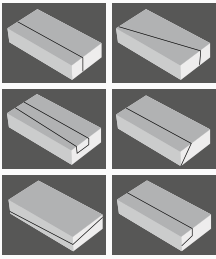

**FESTA****POLISZTIROL VÁGÓ**

- tápfeszültség: 230 V/50 Hz
- teljesítmény: 200 W
- vágás hossz: 137 cm
- vágási vastagság: 30 cm
- Védelem: IP44
- Vágási szög: 0° - 90°
- felszerelés: állvány, lábkapcsoló, állványtartó, 2x Ni-Cr vágóhuzal, tisztító sárgaréz kefe, számszámok és rögzítők, műanyag doboz kerekkel



R.s. Leírás

35348

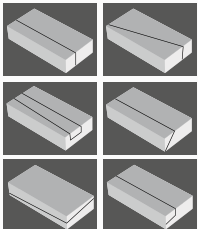

1

**FESTA****POLISZTIROL VÁGÓ**

- tápfeszültség: 230 V / 50 Hz
- teljesítmény: 200 W
- vágás hossz: 137 cm
- vágási vastagság: 30 cm
- Védelem: IP44
- Vágási szög: 0° - 90°



· Felszereltség: Ni - Cr vágószál, tisztító rézkefe, imbusz

R.s. leírás

35345

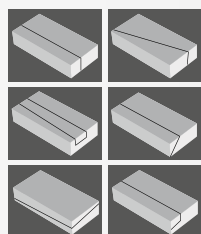

1

**FESTA****POLISZTIROL VÁGÓ**

- tápfeszültség: 230 V / 50 Hz
- teljesítmény: 160 W
- vágás hossz: 120 cm
- vágási vastagság: 52 cm
- Védettség: IP44
- Vágási szög: 0° - 90°



· Felszereltség: Ni - Cr vágószál, tisztító rézkefe, imbusz

R.s. leírás

35344

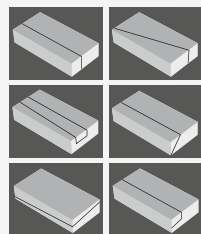

1

**FESTA****POLISZTIROL VÁGÓ**

- tápfeszültség: 230 V / 50 Hz
- teljesítmény: 160 W
- vágás hossz: 120 cm
- vágási vastagság: 30 cm
- Védettség: IP44
- Vágási szög: 0° - 90°



· Felszereltség: Ni - Cr vágószál, tisztító rézkefe, imbusz

R.s. leírás

35330



1

**FESTA****LÁBKAPCSOLÓ**

35330, 35345, 35348 esetén

R.s. Leírás

35334

1

**FESTA****ÁLLVÁNY**

35330, 35345, 35348 esetén

R.s. Leírás

35336

1

**FESTA****CSERERÚGÓ**

35330, 35345, 35348 esetén

R.s. Leírás

35332

1

**FESTA****ÁLLVÁNYTARTÓ**

35330, 35345, 35348 esetén

R.s. Leírás

35333

1

**FESTA****TARTALÉK HÁLÓZATI ADAPTER POLISZTIROL VÁGÓHOZ**

35330, 35345, 35348 esetén



feszültség/frekvencia:	230 V / 50Hz
Kimenet:	36 V / 5 A
erő:	200 W

R.s. Leírás

35347

1

**TARTALÉK FŰTŐSZÁL NI-CR POLISZTIROL VÁGÓHOZ**

R.s. Leírás

35331 117 cm**35346** 137 cm

1





FESTA

VEZETÉK NÉLKÜLI POLISZTIROL VÁGÓ

- akkumulátor 36 V, 1,5Ah Li-ion
- teljesítmény 180 W
- hőmérséklet max 350 C°
- penge hossz 20 cm
- felszerelés: 2 elem, töltő, penge, tisztító sárgaréz kefe, hatlapú



R.sz.	leírás	
35323	Elektromos porisztírol vágó	1
35328	pót penge 14 cm	1
35329	pót penge 25 cm	1

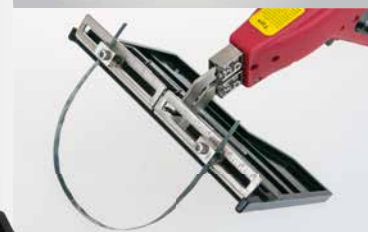

FESTA

ELEKTROMOS PORISZTIROL VÁGÓ

- tápfeszültség 230 V/50 Hz
- teljesítmény 250 W
- hőmérséklet 50-600 C°
- penge hossz 25 cm
- tápkábel hossza 3 m



· Felszereltség: tisztító rézkefe, imbusz, pengék 25 és 30 cm, tartó doboz

R.sz.	leírás	
35326	Elektromos porisztírol vágó	1
35328	pót penge 14 cm	1
35329	pót penge 25 cm	1



VEZETŐ SABLON

R.sz.	leírás	
35327	vezető sablon	1
35335	pót penge - 30 cm	1



FESTA

ELEKTROMOS PORISZTIROL VÁGÓ



· temperature regulation

R.sz.	leírás	
35325	220 W	1



FESTA**POLISZTIROL KÖRKIVÁGÓ****ALU**

R.sz.	leírás	
24752	Ø 65 mm	1
24753	Ø 70 mm	1

**POLISZTIROL KÖRKIVÁGÓ**

R.sz.	leírás	
24727	Ø 65 mm	1
24729	Ø 68 mm	1
24728	Ø 70 mm	1

DÚBEL**100x****MADE IN EU**

R.sz.	leírás		R.sz.	leírás	
39210	Ø 10 x 100 mm	1	39218	Ø 10 x 180 mm	1
39212	Ø 10 x 120 mm	1	39217	Ø 10 x 200 mm	1
39214	Ø 10 x 140 mm	1	39219	Ø 10 x 220 mm	1
39216	Ø 10 x 160 mm	1			

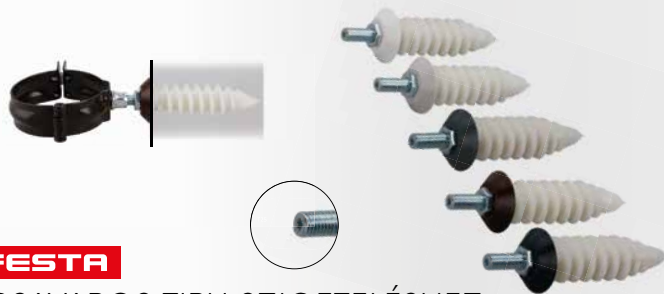
FESTA**CSAVAROS TIPLI SZIGETELÉSHEZ****2x**

R.sz.	leírás	
39240	fehér M10	1
39241	szürke M10	1
39242	antracit M10	1
39243	Barna M10	1
39244	fekete M10	1

SZIGETELÉS ALÁTÉT

Ø 6 és 8 mm-es csavarokhoz

50x

R.sz.	leírás	
39208	Ø 68 mm	1

**MŰGYANTA HENGER****MADE IN EU**

R.sz.	diameter	spike height	hossz	
38950	Ø 69 mm	12 mm	25 cm	10
38951	Ø 69 mm	12 mm	40 cm	8
38952	Ø 122 mm	34 mm	25 mm	10
38953	Ø 122 mm	34 mm	40 cm	8
38954	Ø 122 mm	34 mm	60 mm	4

SZIGETELÉS ALÁTÉT

R.sz.	leírás	
39206	Ø 40 mm	200
39207	Ø 60 mm	100

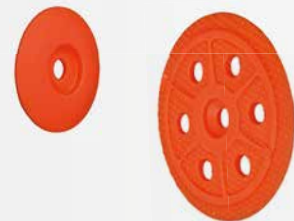
**TÜSKÉSTALP****MADE IN EU**

R.sz.	leírás	
38970	tüské 25 mm	1
38971	tüské 30 mm	1





SZIGETELÉS ALÁTÉT



R.s.	leírás	
42420	Ø 30 mm	1



RABICHÁLÓ



R.s.	leírás	
42312	1 m 50 bm 16 x 16 mm	1

FA ÖLESLÉC



R.s.	hossz	vastagság	szélesség	
37120	200 mm	1,7 mm	20 mm	10
37119	250 mm	1,7 mm	20 mm	10



SZITA



R.s.	szélesség	magas	szem háló	
37216	50 mm	50 mm	2 mm	1
37217	50 mm	50 mm	3 mm	1
37218	50 mm	50 mm	4 mm	1

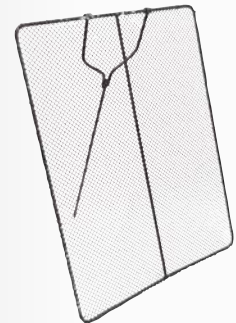

FERDE SZITA

R.s.	szélesség	magas	szem háló	
37236	0,8 m	1 m	10 mm	1
37237	0,8 m	1 m	12 mm	1
37238	0,8 m	1 m	16 mm	1
37239	0,8 m	1 m	20 mm	1



SZÁLERŐSÍTÉS ROST AG. BETONHOZ

- +/- 150 g/ 50 kg cement
- 600 - 900 g/m² beton vagy habarcs



R.s.	leírás	
42115	0,9 kg	9



ÉPÜLET HÁLÓ

R.s.	leírás	
42120	2,5 x 20 m, 80 g/ m ² ZÖLD	5



KÓPORSZORÓ



R.s.	leírás	
37114		1



KÓPORSZORÓ



R.s.	leírás	
37115		1



KAMPÓSSZEG HORGANYZOTT

R.sz.	leírás	MOQ
37231	14 cm	10



KOVÁCSOLT KAMPÓSSZEG

R.sz.	leírás	MOQ
37232	14,5 cm	5



KOVÁCSOLT KAMPÓSSZEG

R.sz.	leírás	MOQ
37230	16 cm	6

ÁCSKAPOCS

R.sz.	leírás	MOQ
37233	320 x 10 mm	100
37234	320 x 12 mm	100

ÁCSKAPOCS

R.sz.	leírás	MOQ
37235	250 x 12 mm	1

PAPÍR ÉLVÉDŐ

R.sz.	leírás	MOQ
39245	AL 30 m x 5 cm	1

ÉLVÉDŐ PVC. MADE IN EU

R.sz.	leírás	MOQ
39238	3 m	25



GIPSZKARTONÓZÓ SPATULA

R.sz.	leírás	MOQ
34308	50 mm	20
34307	80 mm	12
34306	100 mm	10
34305	150 mm	12

GIPSZKARTON EMELŐ

· 153 - 344 cm
· 54 kg

R.sz.	leírás	MOQ
26775		1



GIPSZKARTONÓZÓ SZETT, KOMPLET KLT.

R.sz.	leírás	MOQ
34300	Gipszkarton készlet 9 db	10
34303	kádacska	60



FESTA

GIPSZKARTON HORDOZÓ

R.sz.	leírás	MOQ
36312		12



FESTA

GIPSZKARTON HORDOZÓ

R.sz.	leírás	MOQ
36308	36 x 16,5 x 7,5 cm	10



GIPSZKARTON GYALU

R.sz.	leírás	
22120	250 x 40 mm	10



GIPSZKARTON GYALU

R.sz.	leírás	
22121	250 x 40 mm	10
22122	140 x 40 mm	6



GIPSZKARTON GYALU

R.sz.	leírás	
22126	155 x 40 mm	1



GIPSZKARTON GYALU

R.sz.	leírás	
22125	Ø 250 x 40 mm	6



GIPSZKARTON GYALU

R.sz.	leírás	
22124	Ø 250 x 16 mm	10



GIPSZKARTON GYALU

R.sz.	leírás	
22123	60 x 40 mm	6

FESTA

GIPSZKARTON FŰRÉS

R.sz.	leírás	
24159	150 mm	12



GIPSZKARTON GYALU

R.sz.	leírás	
34315		10
34316	náhradní břit	1



GIPSZKARTON LYUKFÚRÓ

R.sz.	leírás	
24190	300 mm	10

TART. KÉSEK GIPSZKART. GYALUHOZ

R.sz.	leírás	
22130	250 x 40 mm	20
22129	155 x 40 mm	20
22132	140 x 40 mm	20
22133	60 x 40 mm	20
22134	Ø 16 x 250 mm	20



FESTA**GÁZÉGETŐ**

Ø 17, 22, 40 mm



R.s.	leírás	
69918	2 kW, 3 m Tömlő	10

**FESTA****GÁZÉGETŐ**

Ø 25, 35, 50 mm



R.s.	leírás	
69919	19,5 kW, 1,5 m Tömlő	10

**FESTA****ÉG GÁZÉGETŐ Ó**

R.s.	leírás	
69900	Ø 35 mm, hossz 300 mm, Tömlő nélkül	10
69901	Ø 35 mm, hossz 300 mm + 3 m Tömlő	5

**FESTA****GÁZÉGETŐ**

R.s.	leírás	
69914	300 mm + 2 m Tömlő	5

**FESTA****GÁZÉGETŐ**

R.s.	leírás	
69902	Ø 55 mm, hossz 550 mm, Tömlő nélkül	10

**FESTA****GÁZÉGETŐ**

R.s.	leírás	
69903	Ø 55 mm, hossz 550 mm + 3 m Tömlő	10

**FESTA****ÉG GÁZÉGETŐ Ó**

R.s.	leírás	
69905	Ø 55 mm, hossz 900 mm, Tömlő nélkül	10

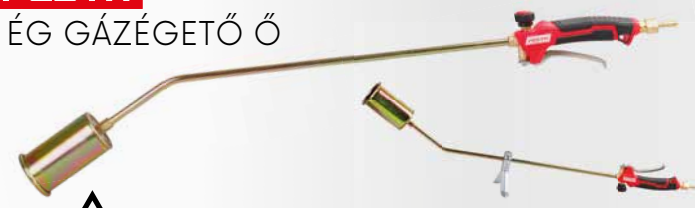
**FESTA****ÉG GÁZÉGETŐ Ó**

R.s.	leírás	
69906	Ø 55 mm, hossz 900 mm + 3 m Tömlő	5



FESTA

GÁZÉGETŐ



Ø 55 mm



R.sz.	leírás	
69904	60 kW, 850 mm, 5 m Tömlő	8

FESTA

GÁZÉGETŐ

propán-bután redukáló szelep
10 a 33 kg



R.sz.	leírás	
69917	Ø 60 mm, hossz 900 mm + 3 m Tömlő 3 m	1

FESTA

TÖMLŐ GÁZÉGETŐHÖZ

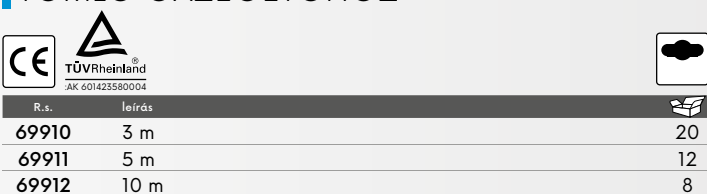

R.sz.	leírás	
69910	3 m	20
69911	5 m	12
69912	10 m	8



NYOMÁSSZABÁLYZÓ

bemeneti csatlakozás	25 bar
kimeneti nyomás	0,5 - 4,0 bar
névleges áramlási sebesség	16 kg h
bemeneti csatlakozás	W 21,8 x 1 14" LH
kimeneti csatlakozás	G3 8" LH



R.sz.	leírás	
69907		1

PROPÁN-BUTÁN REDUKTOR

kimeneti nyomás	4,0 bar
névleges áramlási sebesség	16 kg h
bemeneti csatlakozás	W 21,8 x 1 14" LH
kimeneti csatlakozás	G3 8" LH

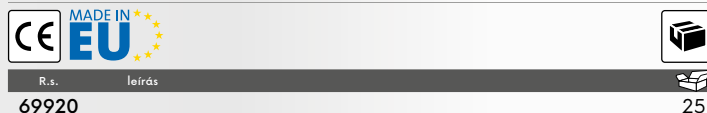

R.sz.	leírás	
69920		25

PROPÁN-BUTÁN REDUKTOR

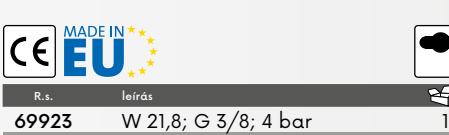

R.sz.	leírás	
69923	W 21,8; G 3/8; 4 bar	1

REDUKTOR

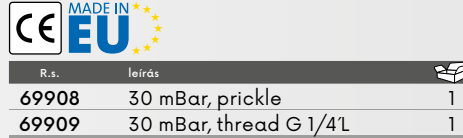

R.sz.	leírás	
69908	30 mBar, prickle	1
69909	30 mBar, thread G 1/4L	1

EGYIRÁNYÚ SZELEP

G 3/8L, 2 kg-os palackhoz

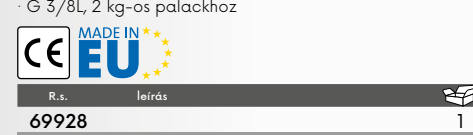

R.sz.	leírás	
69928		1

**FESTA****GÁZLÁMPA, PIEZZÓS, HÁZ NÉLKÜL**

· max. hőmérséklet 1200 °C
 · erő 1,7 kW
 · égő átmérője Ø 20 mm



R.s. leírás
69930 piezo

20

FESTA**GÁZLÁMPA, PIEZZÓS**

· max. hőmérséklet 1200 °C
 · erő 1,7 kW
 · égő átmérője Ø 20 mm



R.s. leírás
69931 piezo

12

**GIPSZELŐ EDÉNY**

R.s. leírás
37121 Konikus



1

**GIPSZELŐ EDÉNY**

R.s. leírás
37122 Alacsony



1

**GIPSZELŐ EDÉNY**

R.s. leírás
33275 Alacsony



20

**HORGANYZOTT VÖDÖR****Zn**

R.s. leírás

39000	5 l	40
39001	10 l	30
39002	12 l	20
39003	15 l	20

**KÓMŰVES VÖDÖR**

R.s. leírás

39005	5 l	1
39010	10 l	1
39012	12 l	1
39014	15 l Öntővel	1
39020	20 l	1
39021	20 l Öntővel	1

**DÉZSA**

R.s. leírás

39192	30 l	20
39193	45 l	20

HABARCSDÉZSA

R.s. leírás

39045	45 l	Ø 54 x 27 cm	1
39065	60 l	Ø 60 x 35 cm	1
39090	90 l	Ø 66 x 35 cm	1

**HABARCSSLÁDA**

R.s. leírás

39145	40 l	71 x 40 x 21 cm	1
39165	65 l	71 x 40 x 30 cm	1
39190	85 l	77 x 48 x 30 cm	1



FESTA

• ütésálló fogantyú
nylon + üvegszál

• 360°-ban forgatható fej

• 3 pozíció
visszapattanó kapcsoló

• dóziszváltás
9:1 / 18:1

FESTA

KINYOMÓPISZTOLY
LÉPTETŐS

R.sz. leírás
38027

1

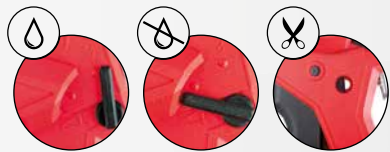

FESTA

KINYOMÓ-
PISZTOLY
LÉPTETŐS

R.sz. leírás
38032 nylon



1



FESTA

KINYOMÓ-
PISZTOLY
LÉPTETŐS

R.sz. leírás
38028

1



FESTA

PROFI
KINYOMÓ-
PISZTOLY

R.sz. leírás
38013

12



FESTA

PROFI
KINYOMÓ-
PISZTOLY

R.sz. leírás
38001

24



FESTA

PROFI
KINYOMÓ-
PISZTOLY

R.sz. leírás
38012

6



FESTA

PROFI
KINYOMÓ-
PISZTOLY

R.sz. leírás
38024

1



KINYOMÓ-
PISZTOLY
LÉPTETŐS



R.s. leírás
38010 6 square 24

KINYOMÓ-
PISZTOLY



R.s. leírás
38025 24

FESTA

KINYOMÓ-
PISZTOLY
LÉPTETŐS,
380 ML



R.s. leírás
38020 12

KINYOMÓ-
PISZTOLY
LÉPTETŐS



R.s. leírás
38006 12

KINYOMÓ
PISZTOLY
LÉPTETŐS



R.s. leírás
38002 6 square 24

KINYOMÓ
PISZTOLY
MŰANYAGBÓL



R.s. leírás
38003 6 square 24

KINYOMÓ
PISZTOLY
KRÓMOZOTT



R.s. leírás
38007 24

KINYOMÓ
PISZTOLY
FÉLIG ZÁRT



R.s. leírás
38008 24

KINYOMÓ
PISZTOLY
FÉLIG ZÁRT



R.s. leírás
38009 24

KINYOMÓ
PISZTOLY
FÉLIG ZÁRT



R.s. leírás
38000 24

FESTA

KINYOMÓPISZTOLY
ALU,
TÖLTHETŐ



ALU

R.sz.	leírás	
38005	310 ml	20
38014	tip 3 db	100

FESTA

KINYOMÓPISZTOLY
ALU,
TÖLTHETŐ



ALU

R.sz.	leírás	
38004	600 ml	12
38014	tip 3 db	100

FESTA

PURHAB
KINYOMÓ
PISZTOLY



TEFLON

R.sz.	leírás	
38018		20

FESTA

PURHAB
KINYOMÓ
TEFLONOS



TEFLON

R.sz.	leírás	
38017		20

FESTA

PURHAB
KINYOMÓ
PISZTOLY



TEFLON

R.sz.	leírás	
38016		20

FESTA

PURHAB
KINYOMÓ
PISZTOLY



TEFLON

R.sz.	leírás	
38015		20

PURHAB
KINYOMÓ



38031

R.sz.	leírás	
38031		20

FESTA

PURHAB
KINYOMÓ



38022 ABS

R.sz.	leírás	
38022	ABS	20

PURHAB
KINYOMÓ



38021

R.sz.	leírás	
38021		24

PURHAB PISZTOLY
TARTALÉK FÚVÓKA

· pisztoly 38015, 38016, 38017, 38018

TEFLON

38030

R.sz.	leírás	
38030		5





ECSET

R.sz.	szélesség	vastagság	hossz	
52212	20 mm	15 mm	40 mm	12
52213	30 mm	15 mm	45 mm	12
52214	40 mm	15 mm	45 mm	12
52215	50 mm	15 mm	50 mm	12
52216	60 mm	15 mm	60 mm	12
52217	70 mm	15 mm	65 mm	12
52218	80 mm	15 mm	65 mm	12
52220	100 mm	15 mm	70 mm	12



ECSET

R.sz.	szélesség	vastagság	hossz	
52202	20 mm	12,5 mm	38 mm	12
52203	30 mm	13 mm	38 mm	12
52204	40 mm	14 mm	44 mm	12
52205	50 mm	16 mm	44 mm	12
52206	60 mm	17 mm	52 mm	12
52208	80 mm	17 mm	52 mm	12
52207	100 mm	18 mm	52 mm	12



SAROK ECSET

R.sz.	szélesség	vastagság	hossz	
52283	25 mm	10 mm	44 mm	12
52284	38 mm	10 mm	44 mm	12
52285	50 mm	10 mm	44 mm	12
52286	62 mm	10 mm	50 mm	12
52288	76 mm	10 mm	50 mm	12



ECSET KLT

3x

R.sz.	leírás	
52070	20, 30, 50 mm	50



KÖRKEFE

MADE IN EU

R.sz.	leírás	
52075	Ø 90 mm	10



TAPÉTÁZÓ KEFE

MADE IN EU

R.sz.	szélesség	hossz	
52076	170 mm	80 mm	10



ECSET KLT

5x

R.sz.	leírás	
52071	15 mm, 25 mm, 40 mm, 60 mm, 80 mm	50



KÖRKEFE

R.sz.	szélesség	hossz	
52077	Ø 105 mm	70 mm	12



KEFE

R.sz.	szélesség	hossz	
52078	170 mm	70 mm	12

FESTŐHENGEREK KIVÁLASZTÁSA

FESTÉKEK VAGY LAKKOK

ANYAG	SZÁL HOSSZ.	DISZPERZIÓS	ROZSDAGÁTLÓ	GYANTÁS	OLAJFESTÉK	VÍZES BÁZISÚ	POLÉSZTER	KÖTŐANYAG	LAZUR	LATEX	EPOXY	KÉT-KOMPONENSŰ	SÚRÚ ANYAGOK	AKRIL
PES	20	•						•		•			•	
PES	20	•	•			•		•		•				•
PAC	18	•						•		•				
PAC	12, 13	•								•				
PAD	18, 21	•								•				
PAD	13	•	•							•				
BÁRÁNY	23	•								•				
NYLON	13		•	•	•	•	•			•	•	•		
VELOUR	4		•	•			•				•	•	•	
MICROFIBRE	10					•			•	•				
MOLITAN				•		•								•

POLYACRYL FESTŐHENGER

PAC						
MADE IN EU						
R.s.						
52331	100 mm	∅ 6 mm	∅ 17 mm	12 mm	50	
52334	250 mm	∅ 8 mm	∅ 48 mm	12 mm	10	



POLYACRYL FESTŐHENGER

PAC						
MADE IN EU						
R.s.						
52391	polster 5 250 mm	∅ 8 mm	∅ 54 mm	18 mm	10	



POLYACRYL FESTŐHENGER

PAC						
MADE IN EU						
R.s.						
52328	polster 5 250 mm	∅ 8 mm	∅ 54 mm	18 mm	10	
52456	polster 7 250 mm	∅ 8 mm	∅ 67 mm	18 mm	10	



POLYAMID FESTŐHENGER

PAD						
MADE IN EU						
R.s.						
52428	polster 7 250 mm	∅ 8 mm	∅ 67 mm	18 mm	10	



LAKKOZÓ FESTÉKHENGER,

PAD						
MADE IN EU						
R.s.						
52421	100 mm	∅ 6 mm	∅ 17 mm	13 mm	50	
52424	250 mm	∅ 8 mm	∅ 48 mm	13 mm	10	



POLYESTER FESTŐHENGER

PES						
MADE IN EU						
R.s.						
52305	180 mm	∅ 6 mm	∅ 42 mm	20 mm	10	
52306	250 mm	∅ 6 mm	∅ 42 mm	20 mm	10	



LAKKOZÓ FESTÉKHENGER

MADE IN EU					
R.s.					
52471	rovny 100 mm	∅ 6 mm	∅ 35 mm	50	



FESTŐHENGER SZETT

PAC

MADE IN EU

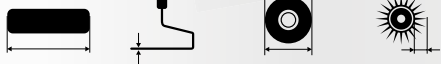

R.s.	leírás	szélesség	magasság	nyél átmérője	nyél hosszúsága	csomagolás
52600	polster 4	180 mm	Ø 8 mm	Ø 53 mm	18 mm	1



FESTŐHENGER SZETT

PES

MADE IN EU

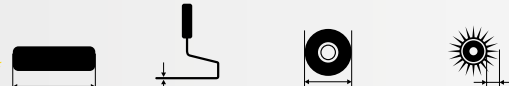

R.s.	leírás	szélesség	magasság	nyél átmérője	nyél hosszúsága	csomagolás
52610		180 mm	Ø 6 mm	Ø 42 mm	20 mm	25
52605		250 mm	Ø 6 mm	Ø 42 mm	20 mm	20



FESTŐHENGER SZETT

- 1x festőhenger PAD 13mm/10cm
- 1x festőhenger PAC 12mm/10cm
- 1x festőhenger PES 11cm
- markolat +tál

MADE IN EU

R.s.	leírás	csomagolás
52602		10



SAROK FESTÉKHENGER

PAC

MADE IN EU

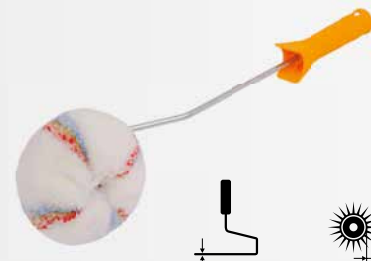

R.s.	leírás	nyél átmérője	nyél hosszúsága	csomagolás
52601	fogantyúval	Ø 6 mm	18 mm	1

TÁL

MADE IN EU

R.s.	leírás	szélesség	magasság	csomagolás
52662	150 x 270 mm	100 mm	1	
52666	260 x 290 mm	180 mm	1	
52671	330 x 340 mm	250 mm	1	



FESTŐ VÖDÖR

MADE IN EU

R.s.	objem	csomagolás
52694	8 l	25
52695	12 l	20



RÁCS

MADE IN EU

R.s.	szélesség	magasság	csomagolás
52652	230 mm	250 mm	100
52656	270 mm	290 mm	100



FESTŐHENGER NYÉL

MADE IN EU

R.s.	leírás	csomagolás
52640	5 cm Ø 6 mm	100
52645	8,5 cm Ø 6 mm x 27 mm	100



FESTŐHENGER NYÉL

MADE IN EU

R.s.	leírás	csomagolás
52630	18 cm Ø 6 mm	100
52635	25 cm Ø 6 mm	100
52620	18 cm Ø 8 mm	50
52625	25 cm Ø 8 mm	50



FESTÉK ÉS LAKK KAPARÓ

R.s.	csomagolás
37005	12



FESTA

TELESZKÓPOS RÚD

csavar 31610, 34203

R.s.	leírás	
52011	88 - 140 cm	1

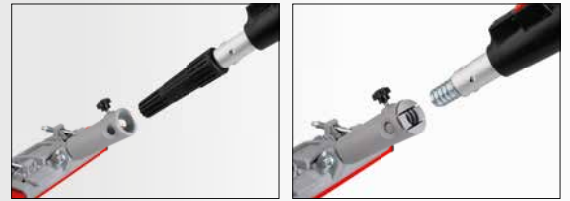

TELESZKÓPOS RÚD

ALU

R.s.	length		
52010	120 cm	ALU	50
52012	240 cm	ALU	25



TELESZKÓPOS RÚD

R.s.	length		
52020	300 cm	ocel	10



TELESZKÓPOS RÚD

R.s.	length		
52030	240 cm	fiberglass	6



TAKARÓFÓLIA TEKERCSEBEN

R.s.	szélesség	hossz	
37243	55 cm	30 m	60
37244	110 cm	30 m	30
37245	140 cm	30 m	30
37246	180 cm	15 m	30
37290	210 cm	20 m	30
37247	240 cm	15 m	30
37291	270 cm	16 m	30



FESTŐOVERÁL

R.s.	leírás	
50585	méret M	1
50586	méret L	1
50587	méret XL	1
50588	méret XXL	1



**PORVÉDŐ AJTÓHOZ
CIPZÁRRAL**

R.s.	leírás	
37248	1,2 x 2,2 m 100 µm tape 45 mm x 25 m	25



UNIVERZÁLIS TAKARÓFÓLIA

R.s.	objem	vastagság	
37250	4 x 5 m	0,007 mm	100
37251	4 x 12,5 m	0,007 mm	50
37252	2 x 50 m	0,007 role	20



UNIVERZÁLIS TAKARÓFÓLIA

R.s.	leírás	vastagság	
37253	4 x 5 m	0,03 mm	100

HULLÁMPAPÍR



R.s.	szélesség	hossz	
54008	1 m	10 m	1

FESTA



LETAKARÓ PONYVA PROFI

kék-ezüst

140 g/m²



R.s.	leírás	
25206	2 x 3 m	25
25212	3 x 4 m	10
25215	3 x 5 m	8
25220	4 x 5 m	8
25224	4 x 6 m	8
25230	5 x 6 m	8

R.s.	leírás	
25240	5 x 8 m	4
25248	6 x 8 m	3
25260	6 x 10 m	3
25296	8 x 12 m	2
25350	10 x 15 m	1



LETAKARÓ PONYVA

kék



R.s.	leírás	
25369	2 x 2 m	50
25370	2 x 3 m	20
25371	3 x 4 m	10
25372	3 x 5 m	10
25373	4 x 5 m	10

R.s.	leírás	
25374	4 x 6 m	5
25376	5 x 8 m	5
25378	6 x 10 m	2
25379	8 x 12 m	2
25380	10 x 15 m	2

LETAKARÓ PONYVA STANDARD

kék-ezüst

70 g/m²



R.s.	leírás	
25155	2 x 2 m	50
25006	2 x 3 m	50
25009	3 x 3 m	35
25012	3 x 4 m	20
25015	3 x 5 m	10
25016	4 x 4 m	10
25020	4 x 5 m	10
25024	4 x 6 m	10

R.s.	leírás	
25025	5 x 5 m	10
25030	5 x 6 m	10
25040	5 x 8 m	5
25048	6 x 8 m	5
25060	6 x 10 m	5
25096	8 x 12 m	2
25150	10 x 15 m	2
25153	15 x 20 m	1

LETAKARÓ PONYVA STANDARD

zöld

70 g/m²



R.s.	leírás	
25179	2 x 2 m	50
25180	2 x 3 m	50
25195	2 x 8 m	20
25181	3 x 4 m	20
25182	3 x 5 m	10
25183	4 x 5 m	10

R.s.	leírás	
25184	4 x 6 m	10
25186	5 x 8 m	5
25188	6 x 10 m	5
25189	8 x 12 m	2
25190	10 x 15 m	2

LETAKARÓ PONYVA PROFI

zöld-zöld

200 g/m²



R.s.	leírás	
25160	2 x 3 m	15
25171	2 x 8 m	1
25162	3 x 5 m	5
25163	4 x 5 m	4

R.s.	leírás	
25164	4 x 6 m	3
25167	6 x 8 m	2
25169	8 x 12 m	1
25170	10 x 15 m	1

LETAKARÓ PONYVA

kék-ezüst

120 g/m²



R.s.	leírás	
25003	Ø 3,6 m	15
25004	Ø 4,5 m	5
25005	Ø 5,5 m	4
25002	Ø 6,5 m	3



PONYVAFESZÍTŐ

R.s.	leírás	
25400	20 cm	1



PONYVA RINGLIZÓ

R.s.	leírás	
25410	aplikátor ok + 25 szem	1



PONYVA RINGLI

R.s.	leírás	
25001		1



TELESZKÓPOS ÖSSZECSUKHATÓ LÉTRA

· max. terhelés 150 kg



R.sz.	leírás		
48415	1,9 / 3,8 m	6/12 partíció	1

TELESZKÓPOS LÉTRA

· max. terhelés 150 kg



R.sz.	leírás		
48410	3,2 m	11 partíció	1
48411	3,8 m	13 partíció	1

ÖSSZECSUKHATÓ MUNKAÁLLVÁNY

· max. terhelés 150 kg

ALU

R.sz.	leírás	
48420		1



NEW

2.75m	H L	H L	1.73m	0.93m	0.99m
	1.60m 1.14m	1.69m 1.32m			

ÁLLVÁNY, ÁLLÍTHATÓ MUNKAMAGASSÁG

KG
13,6

· max 150 kg

R.sz.	leírás	
37660		1





ÁLLÍTHATÓ BAK



R.sz.	leírás	
37545	140 cm, magasság 98 - 165 cm	1
37546	120 cm, magasság 98 - 165 cm	1



ZSALUZAT TÁVTARTÓ, ÁLLÍTHATÓ

· 48449 ketrec állítható kellékekhez



R.sz.	leírás	
48452	160 - 290 cm	1
48453	180 - 320 cm	1
48454	200 - 360 cm	1
48455	250 - 440 cm	1
48456	260 - 380 cm	1
48457	220 - 400 cm	1

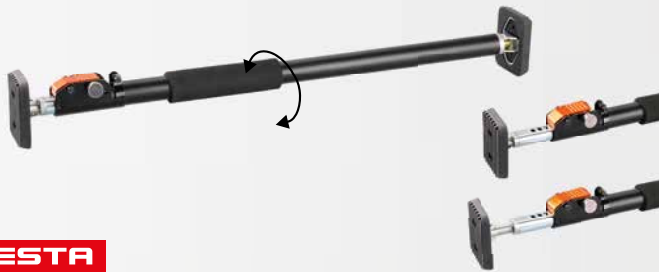

FESTA

ZSALUZAT TÁVTARTÓ, ÁLLÍTHATÓ

· max. terhelés 40 kg

R.sz.	leírás		
52060	66 - 115 cm	1	
52065	160 - 290 cm	1	



ZSALUZAT TÁVTARTÓ, ÁLLÍTHATÓ

R.sz.	leírás		
52050	50 - 115 cm	1	
52055	115 - 290 cm	1	

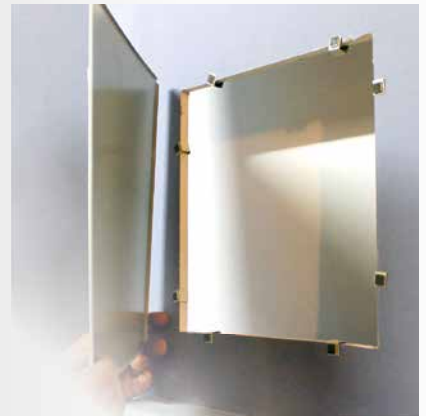

SZERELŐ ABLAK MÁGNESES

	R.sz.	leírás	
	82100	10 - 21 cm	1
	82101	20 - 31 cm	1
	82102	30 - 41 cm	1
	82103	40 - 51 cm	1
	82104	50 - 58 cm	1



KÉMÉNYAJTÓ, FÉM



R.sz.	leírás	
65062		1



KÉMÉNYAJTÓ, FÉM



R.sz.	leírás	
65063	szürke	1
65064	fehér	1



KÉMÉNYAJTÓ, FÉM



R.sz.	leírás	
65065		1



310

WINLAND METSZŐOLLÓ



312

METSZŐOLLÓ



315

BOZÓTVÁGÓ KÉS



315

KERTI SZERSZÁMOK



316

FEJSZE



318

KERTÉSZETI ESZKÖZÖK



320

FENŐKŐ



321

FÚNYÍRÓ DAMIL



321

FÁTYOLFÓLIA



322

NÖVÉNYFUTTATÓ
DRÓTBÓL

324

LOCSOLÓPISZTOLY



332

TÖMLŐ ÖSSZEKÖTŐ



333

TÖMLŐTARTÓ KOCSI,
MUANYAG

334

ÖNTÖZOKANNA



335

KÉZI PERMETEZO



337

GEREBLYE



341

ÁSÓ ÉS LAPÁT

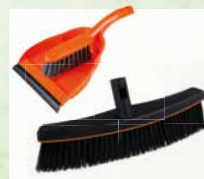

348

BETONSEPRŰ



350

NYÉL

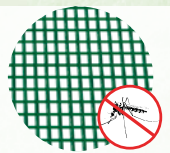

352

SZÚNYOGHÁLÓ

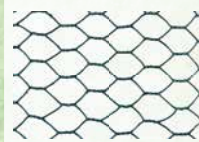

353

DRÓTHÁLÓ



356

OSZLOPTALP



357

ÁRNYÉKOLÓTEXTIL



358

GRILLESZKÖZ



KERTI SZERSZÁMOK ÉS KERÍTÉS **308 - 359**



WINLAND®
METSZŐOLLÓ

SK5

R.sz.	leírás	
45020	205 mm	10
44980	Tartalék rugó	1

WINLAND®
METSZŐOLLÓ

SK5

R.sz.	leírás	
45023	205 mm	10
44980	Tartalék rugó	1

WINLAND®
METSZŐOLLÓ

SK5

R.sz.	leírás	
45063	215 mm	10
44981	Tartalék rugó	1

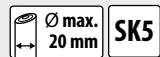
WINLAND®
METSZŐOLLÓ

SK5

TEFLON

R.sz.	leírás	
44972	215 mm	10
44981	Tartalék rugó	1

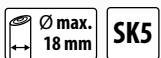
WINLAND®
METSZŐOLLÓ

SK5

R.sz.	leírás	
45099	190 mm	10
44983	Tartalék rugó	1

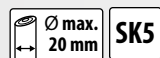
WINLAND®
METSZŐOLLÓ

SK5

R.sz.	leírás	
45098	220 mm	10
44983	Tartalék rugó	1

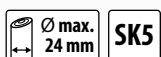
WINLAND®
METSZŐOLLÓ

SK5

TEFLON

R.sz.	leírás	
45095	200 mm	10
44982	Tartalék rugó	1

WINLAND®
METSZŐOLLÓ

SK5

TEFLON

R.sz.	leírás	
45096	220 mm	6
44982	Tartalék rugó	1





METSZŐOLLÓ



INOX max. mm INOX

R.s. leírás
45089 160 mm



10



METSZŐOLLÓ



SK5 TEFLON SK5 TEFLON

R.s. leírás
45097 210 mm
44981 Tartalék rugó



10

1



METSZŐOLLÓ



INOX max. 10 mm

R.s. leírás
45088 160 mm



10



max. 12 mm

TELESZKOPÓS ÁGVÁGÓ

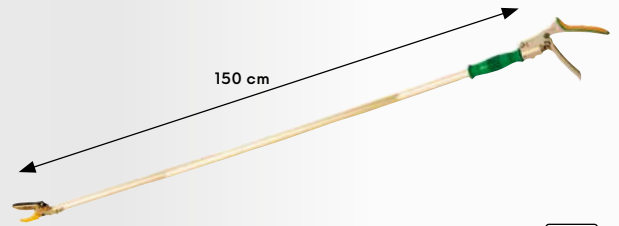

R.s. leírás
45017



10



TARTALÉK RUGÓ



R.s.	noyze	Icon
44981	45021, 45025, 45063, 45097	1
44980	45020, 45023	1
44983	45098, 45099	1
44982	45027, 45095, 45096	1
44984	45110, 45014, 45026	1
44985	45018	1



PENGÉK



• mert 45095, 45027

R.s. leírás
45094



20



ÁGVÁGÓ OLLÓ



max. 45mm SK5 TEFLON

R.s. leírás
44991 76 cm

12



ÁGVÁGÓ OLLÓ



max. 45mm SK5 TEFLON

R.s. leírás
44992 70 - 103 cm

10



SÖVÉNYVÁGÓ OLLÓ

TEFLON

R.sz.	leírás	
44996	61 cm, hullámél	12



ÁGVÁGÓ OLLÓ

TEFLON

R.sz.	leírás	
44997	61 cm, rovné ostfí	12

FÚNYÍRÓ OLLÓ, 360°
FORGATHATÓ MARKOLAT

R.sz.	leírás	
44998		6

OLLÓ ÉLEZŐ
GYÉMÁNTOS 6V1

R.sz.	leírás	
45068		10

OLLÓ ÉLEZŐ
GYÉMÁNTOS

R.sz.	leírás	
45048		20



FESTA

METSZŐOLLÓ

nylon fogantyú



R.sz.	leírás	
45021	210 mm	6



METSZŐOLLÓ



R.sz.	leírás	
45019	210 mm	10



FESTA

METSZŐOLLÓ



R.sz.	leírás	
45010	190 mm	12
44984	Tartalék rugó	1



METSZŐOLLÓ



R.sz.	leírás	
45014	190 mm	12
44984	Tartalék rugó	1



METSZŐOLLÓ

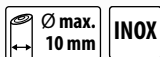

R.sz.	leírás	
45026	150 mm	12
44985	Tartalék rugó	1

METSZŐOLLÓ
KOVÁCSOLT

R.sz.	leírás	
45018	210 mm kované	10



METSZŐOLLÓ



R.s. leírás
45025 200 mm



12

METSZŐOLLÓ



R.s. leírás
44970 210 mm



10

METSZŐOLLÓ

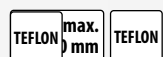

R.s. leírás
45027 200 mm



10

METSZŐOLLÓ



R.s. leírás
45029 200 mm



24

METSZŐOLLÓ



R.s. leírás
44971 160 mm



10

METSZŐOLLÓ

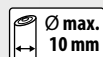

R.s. leírás
45016 180 mm



12

SZÜRETELŐ OLLÓ,
EGYENES

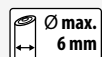

R.s. leírás
45015 190 mm, egyenes



12

METSZŐOLLÓ TOK



R.s. leírás
37317



1

FÚNYÍRÓ OLLÓ

R.s. leírás
45011 300 mm



1

FÚNYÍRÓ OLLÓ,
180° FORGARHATÓ
MARKOLAT

R.s. leírás
45012 370 mm, turning 180°



1



ÁGVÁGÓ
OLLÓ

nylon fogantyú



R.s. leírás
44999 540 mm, kerek

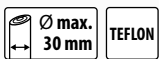
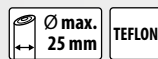
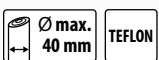
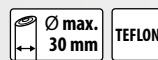

12

FESTAÁGVÁGÓ
OLLÓR.s. leírás
45000 750 mm, kerek**FESTA**ÁGVÁGÓ
OLLÓR.s. leírás
45001 710 mm, kerek**FESTA**ÁGVÁGÓ
OLLÓR.s. leírás
45002 750 mm, KadbolókerékkelÁGVÁGÓ
OLLÓR.s. leírás
45003 660-900 mm, teleszkópikus**FESTA**

SÖVÉNYVÁGÓ OLLÓ

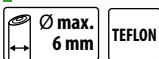
R.s. leírás
45005 580 | 230 mm,
hullámél**FESTA**

SÖVÉNYVÁGÓ OLLÓ

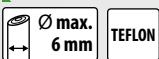
R.s. leírás
45006 580 | 230 mm,
egyenes él**FESTA**

SÖVÉNYVÁGÓ OLLÓ

R.s. leírás
45007 670-870 | 230 mm,
hullámél

SÖVÉNYVÁGÓ OLLÓ

R.s. leírás
44995 440 | 160 mm

SÖVÉNYVÁGÓ OLLÓ

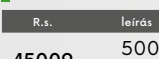
R.s. leírás
45009 500 | 190 mm,
hullámél

SÖVÉNYVÁGÓ OLLÓ

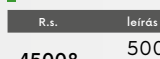
R.s. leírás
45008 500 | 190 mm,
egyenes él

SARLÓ

R.s. leírás
45490 450 mm

FESTA

BOZÓTVÁGÓ
KÉS



TEFLON

R.sz.	leírás	
45069	440 mm	6

FESTA

BOZÓTVÁGÓ
KÉS



TEFLON

R.sz.	leírás	
44950	490 mm	4

BOZÓTVÁGÓ
KÉS

INOX

R.sz.	leírás	
45083	430 mm	12
45084	600 mm	6



BOZÓTVÁGÓ
KÉS

· fogantyú körből készült

R.sz.	leírás	
45081	510 mm	36
45082	710 mm	36



FESTA

BECSUKHATÓ KERTIFŰRÉSZ

· 3x élezett, edzett fogazás

R.sz.	leírás	
45061	150 mm összecukható	12



FESTA

BECSUKHATÓ KERTIFŰRÉSZ

· 3x élezett, edzett fogazás

R.sz.	leírás	
45060	180 mm	6



FESTA

KERTIFŰRÉSZ TOKKAL

· 3x élezett, edzett fogazás

R.sz.	leírás	
45062	260 mm esettel	24



FESTA

ÍVES ÁGVÁGÓ FŰRÉSZ

· 3x élezett, edzett fogazás

R.sz.	leírás	
24152	350 mm 7 tpi	12



FESTA

TELESZKÓPOS ÁGVÁGÓ FŰRÉSZ

· 3x élezett, edzett fogazás

R.sz.	leírás	
45033	230 - 490 mm	1



ÁGVÁGÓ
FŰRÉSZ

R.sz.	leírás	
45030	fűrész 30 cm teleszkópos pólus 240 cm	6
45031	fűrész 30 cm	6



ÁGVÁGÓ
FŰRÉSZ

R.sz.	leírás	
45032	Fém, fűrész nélkül	6





FESTA

FESTA

FEJSZE

DIN
5131

DIN
7294

- kőrisfa nyél
- kör alakú ék



R.s.	leírás		R.s.	leírás	
19380	600 g	1	19384	1400 g	1
19381	800 g	1	19385	1600 g	1
19382	1000 g	1	19387	2000 g	1
19383	1250 g	1			

FESTA

SZEKERCE

- kőrisfa nyél



R.s.	leírás	
19340	700 g	22

FESTA

HASÍTÓ FEJSZE

- kőrisfa nyél
- kör alakú ék

DIN 5129	R.s.	leírás	
	19389	3000 g	1
	19388	4000 g	1



FESTA

HASÍTÓ FEJSZE ÉKES

- kőrisfa nyél
- kör alakú ék

DIN 7294		R.s.	leírás	
		19391	2000 g	1



FESTA

FEJSZE ÜVEGSZÁLAS

- fiberglass

C.p.	specifikace	
19326	600 g	6
19328	800 g	24
19330	1000 g	12
19332	1250 g	8
19333	1500 g	6
19335	1600 g	6
19337	2000 g	6



FESTA

FEJSZE ÜVEGSZÁLAS

- üvegszálás nyél

C.p.	specifikace	
19392	1000 g	6



FESTA

FEJSZE, KEMPING,
ÜVEGSZÁLAS

- üvegszálás nyél

C.p.	specifikace	
19301	500 g	6



FESTA

FEJSZE ÜVEGSZÁLAS

- üvegszálás nyél

R.s.	leírás	
19390	2000 g	6





FESTA

HASÍTÓ FEJSZE ÜVEGSZÁLAS

üvegszálás nyél

R.sz.	leírás	
19370	3000 g	4
19371	4000 g	4



FEJSZE NYÉL



Č.p.	specifikace	pro sekeru	
61340	36 cm	19380	10
61341	40 cm	19381, 19340	10
61342	50 cm	19382	10
61343	70 cm	19383, 19384	10
61344	80 cm	19385, 19391	10
61345	90 cm	19387	10
61346	90 cm	19388, 19389	10

FEJSZE

Č.p.	specifikace	
19306	600 g	24
19308	800 g	24
19310	1000 g	24
19312	1250 g	12
19314	1500 g	12



HASÍTÓ ÉK

R.sz.	leírás	
19397	2000 g 55 x 210 x 45 mm	10
19465	2500 g 65 x 230 x 45 mm	10



HASÍTÓ ÉK



R.sz.	leírás	
19462	175 x 65 x 20 mm	1
19463	230 x 70 x 30 mm	1
19464	240 x 75 x 40 mm	1



HASÍTÓ ÉK

R.sz.	leírás	
19394	1000 g 35 x 180 x 40 mm	6
19395	2000 g 40 x 255 x 55 mm	6
19396	2500 g 40 x 260 x 55 mm	8



SDS+ HASÍTÓTÜSKE

SDS+

R.sz.	leírás	
19393	Ø 32 x 132 mm	10
19374	Ø 42 x 145 mm	10



HASÍTÓ ÉK

R.sz.	leírás	
19469	2500 g 165 x 87 mm	10

KERTI
LAPÁT,
SZÉLES

INOX



R.sz.	leírás	
45056	360 mm	12

KERTI
LAPÁT,
KESKENY

INOX



R.sz.	leírás	
45057	360 mm	12

KERTI KAPA
EGYENES

INOX



R.sz.	leírás	
45058	270 mm	12

GYOMLÁLÓ

INOX



R.sz.	leírás	
45059	360 mm	12

KERTI
LAPÁT,
SZÉLES

NYLON



R.sz.	leírás	
45065	280 mm	1

KERTI
LAPÁT,
KESKENY

NYLON



R.sz.	leírás	
45066	310 mm	1

KERI
VILLA

NYLON



R.sz.	leírás	
45067	290 mm	1

KERTI
KÉSZLET

HOBBY 4x



R.sz.	leírás	
45035	240 mm	35

KERTI
KAPA, LAPOS

R.sz.	leírás	fogantyú hossza	
61294	140 mm	27 cm	MOQ 3
61221	fa nyél	27 cm	1

KERTI
KAPA, HEGYES

R.sz.	leírás	fogantyú hossza	
61295	140 mm	27 cm	MOQ 3
61221	fa nyél	27 cm	1

KERTI
HOROLÓ

R.sz.	leírás	fogantyú hossza	
61296	175 mm	27 cm	MOQ 3
61221	fa nyél	27 cm	1

KERTI
KAPARÓ

R.sz.	leírás	fogantyú hossza	
61297		27 cm	MOQ 3
61221	fa nyél	27 cm	1





ÖSSZECSUKHATÓ LAPÁT

Eset, carcasá

R.sz.	leírás	
61085	410 mm	6



PALÁNTÁZÓ

INOX

R.sz.	leírás	
45040	230 mm	60



ÜLTETŐ "T"

R.sz.	leírás	
45038	280 mm	60



GYOMLÁLÓ KÉS

R.sz.	leírás	
45079	200 mm	1



GYOMLÁLÓ KÉS

R.sz.	leírás	
45080	200 mm „L”	1



GYÜMÖLCSSZEDŐ



R.sz.	leírás	
45041		75



GYÜMÖLCSSZEDŐ

R.sz.	leírás	
45039		50
45034	170 - 300 cm, nyéllel	5



GYOMLÁLÓ

R.sz.	leírás	
44955	950 mm	16



KULTIVÁTOR, NYELEZHETŐ

R.sz.	leírás	
45042	160 x 132 cm	12



KULTIVÁTOR, NYELEZHETŐ

R.sz.	leírás	
44053		12
61251	160 cm fogantyú	1



SZÓRÓ ÜLTETŐ KOCSI

LEÍRÁS

magasság:	111 cm
szélesség:	55 cm
hangerő:	12 l

R.sz.	leírás	
45085	12 l	1

FESTA

ÉLEZŐ 16v1



	30° Anvil	
	45° Anvil	
	50° Anvil	
	23° Bypass	
	35° Bypass	
	65° Bypass	
	Deburrr Tool	



R.s. leírás
45073

1



ÉLEZŐ



R.s. leírás
45068

10



ÉLEZŐ



R.s. leírás
45048

20

FENŐKŐ

R.s. leírás
45046 205 x 15 mm 100



FENŐKŐ

R.s. leírás
45370 250 x 33 x 18 mm 20



FENŐKŐ

R.s. leírás
45045 150 x 50 x 30 mm 10



ÉLEZŐ

R.s. leírás
16991 20



FENŐKŐ

R.s. leírás
16990 Ø 50 mm 50





FÚNYÍRÓ DAMIL



R.sz.	leírás	csomagolás
45530	2 mm x 15 m	1
45531	2,4 mm x 15 m	1
45532	3 mm x 15 m	1
45533	3,15 mm x 15 m	1
45534	4 mm x 15 m	1



FÚNYÍRÓ DAMIL

R.sz.	leírás	csomagolás
45520	2 mm x 162 m	10
45521	2,4 mm x 112 m	10
45528	2,7 mm x 90 m	10
45522	3 mm x 72 m	10
45525	2 mm x 162 m	10
45526	2,4 mm x 112 m	10
45529	2,7 mm x 90 m	10
45527	3 mm x 72 m	10



FÚNYÍRÓ DAMIL

R.sz.	leírás	csomagolás
45500	1,3 mm x 15 m	30
45502	1,3 mm x 15 m	30
45503	1,6 mm x 15 m	20
45505	1,6 mm x 15 m	20
45506	2 mm x 15 m	12
45508	2 mm x 15 m	12
45517	2 mm x 15 m	10
45509	2,4 mm x 15 m	12
45511	2,4 mm x 15 m	12
45512	2,4 mm x 15 m	12
45518	2,4 mm x 15 m	10
45523	2,7 mm x 15 m	10
45524	2,7 mm x 15 m	10
45513	3 mm x 15 m	10
45515	3 mm x 15 m	10
45516	3 mm x 15 m	10
45519	3 mm x 15 m	10



FÁTYOLFÓLIA



R.sz.	leírás	csomagolás
45540	1,6 x 5 m	40
45541	1,6 x 10 m	40
45542	1,6 x 50 m egy szerepben	1
45543	1,6 x 100 m egy szerepben	1



R.sz.	leírás	csomagolás
45550	1,6 x 5 m	50
45551	1,6 x 10 m	20
45564	3,2 x 10 m	20
45552	1,6 x 50 m egy szerepben	1
45553	1,6 x 100 m egy szerepben	1
45562	3,2 x 50 m egy szerepben	1
45563	3,2 x 100 m egy szerepben	1

FÁTYOLFÓLIA



R.sz.	leírás	csomagolás
45556	1,6 x 5 m	50
45557	1,6 x 10 m	20
45565	3,2 x 10 m	20
45558	1,6 x 50 m egy szerepben	1
45559	1,6 x 100 m egy szerepben	1

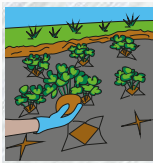

FÁTYOLFÓLIA

uv
STABLE 45 g/m²

R.sz.	leírás	
45535	1,6 x 5 m	18



RÖGZÍTŐ KERTI TAKARÓ SZÖVETEKHEZ

10x

R.sz.	leírás	
45555	11,5 cm	1

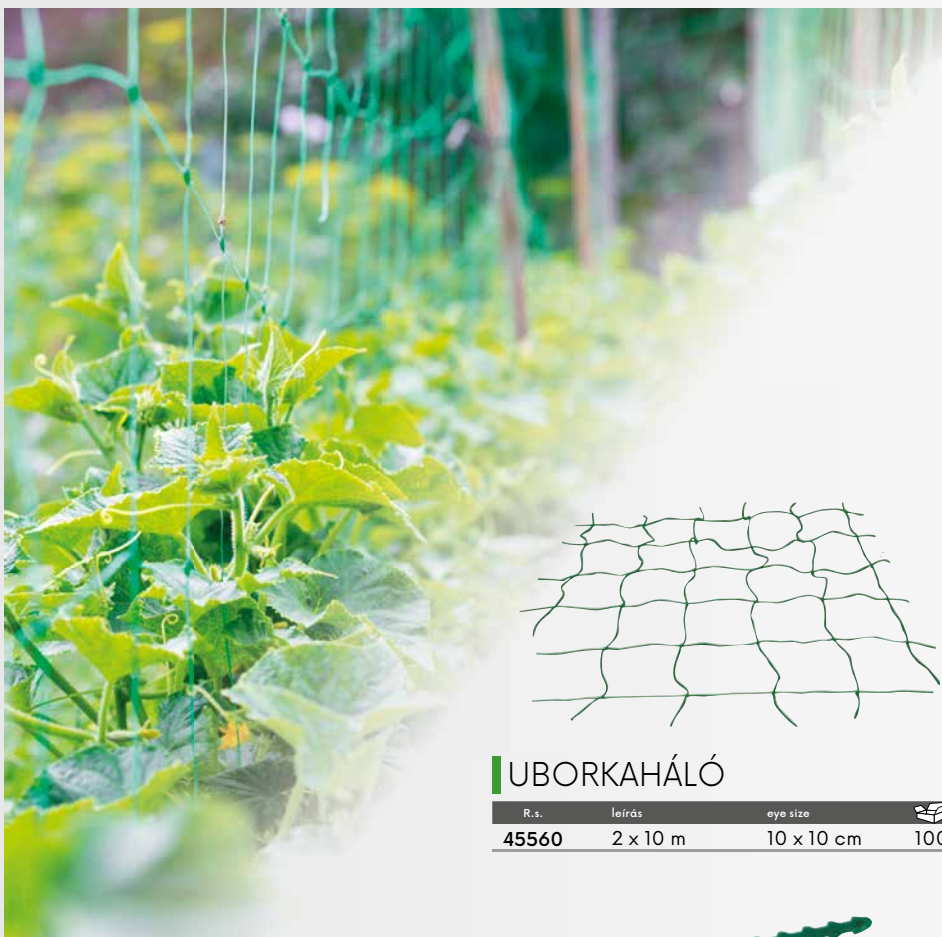

UBORKAHÁLÓ

R.sz.	leírás	eye size	
45560	2 x 10 m	10 x 10 cm	100

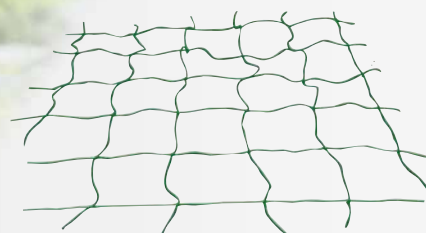

NÖVÉNYFUTTATÓ ÜVEGSZÁLAS

R.sz.	leírás	
45036	180 cm Ø 7,9 mm	100



FOGAS RÖGZÍTŐ SZALAG

50x

R.sz.	leírás	
23840		20



MŰANYAG BEVONATÚ KERTI RÚD

R.sz.	leírás		R.sz.	leírás		R.sz.	leírás	
45650	90 cm Ø 8 mm	25	45655	150 cm Ø 11 mm	25	45659	180 cm Ø 16 mm	25
45651	120 cm Ø 8 mm	25	45656	180 cm Ø 11 mm	25	45660	210 cm Ø 16 mm	25
45652	150 cm Ø 8 mm	25	45661	210 cm Ø 11 mm	25	45662	150 cm Ø 20 mm	10
45653	90 cm Ø 11 mm	25	45657	120 cm Ø 16 mm	25	45663	180 cm Ø 20 mm	10
45654	120 cm Ø 11 mm	25	45658	150 cm Ø 16 mm	25	45664	210 cm Ø 20 mm	10



NÖVÉNYFUTTATÓ DRÓTBÓL

R.sz.	leírás	
44041	1,2 m, Ø 5,5 mm komaxit - green	10
44042	1,5 m, Ø 6 mm komaxit - green	10
44043	1,8 m, Ø 6 mm komaxit - green	10
45049	1,8 m, Ø 7 mm komaxit - green	10
45044	1,8 m, Ø 7 mm komaxit - silver	10
44050	2,2 m, Ø 7 mm komaxit - green	10

CSATLAKOZÓ IDOM, MŰ.A

MOQ
10

R.sz.	leírás	
45670	8 mm	10
45671	11 mm	10
45672	16 mm	10
45673	20 mm	10





TÉPŐZÁRAS SZALAG



R.s.	leírás	
45471	12 mm x 5 m	1



KÖTŐZÓDRÓT



R.s.	leírás	
45043	30 m	30

KÖTŐ HUZAL GUMIZÁSSAL



R.s.	leírás	
23845	3 mm x 8 m	30
23846	4 mm x 6 m	30
23847	5 mm x 4 m	30



KÖTŐSZALAGOK

3x



R.s.	leírás	
45472	3 cm x 3 m, 3 db	36



KÖTŐZŐSZALAG



R.s.	leírás	
45473	3 cm x 50 m	60



KERTI TÉRDEPLŐ

R.s.	leírás	
45086	40 x 18 x 2 cm	50



ÖSSZECSUKHATÓ KERTISZÉK

· for sitting and upside down for kneeling



R.s.	leírás	
45074	58 x 48 x 28 cm	4



KERTI KOSÁR, ÖSSZECSUKHATÓ

R.s.	leírás	
45093	40 x 25 x 23 cm	10



DÉZSA



R.s.	leírás	
39192	26 l	20
39193	42 l	20



LOMBGYÜJTŐ ZSÁK

R.s.	leírás	
45047	55 x 70 cm, 3 drzadla	20



LOMBGYÜJTŐ ZSÁK

R.s.	leírás	
44960	200 l 60 x 60 x 55 cm	50



FESTA®
AQUATIC

FESTA®
AQUATIC

**LOCSOLÓ-
PISZTOLY**

- 7 funkció
- szabályzó kar elől, rögzíthető
- könnyű vízszugár vezérlés



R.s. leírás **45386** 12

FESTA®
AQUATIC

**LOCSOLÓ-
PISZTOLY**

- állítható vízszugár
- szabályzó kar elől, rögzíthető
- könnyű vízszugár vezérlés



R.s. leírás **45388** 12

FESTA®
AQUATIC

SUGÁRCSŐ

- állítható vízszugár



R.s. leírás **45389** 24



FESTA®
AQUATIC

**SUGÁRCSŐ
KLT.**

- állítható vízszugár



R.s. leírás **45385** 4 db 12

FESTA®
AQUATIC

TÖMLŐ ÖSSZEKÖTŐ



R.s. leírás **45390** 24

FESTA®
AQUATIC

GYORSCSATLAKOZÓ



R.s. leírás **45392** 24

FESTA®
AQUATIC

**GYORSCSATLAKOZÓ,
STOPPAL**



R.s. leírás **45394** 24

FESTA®
AQUATIC

TÖMLŐ ÖSSZEKÖTŐ



R.s. leírás **45391** 24

FESTA®
AQUATIC

GYORSCSATLAKOZÓ



R.s. leírás **45393** 24

FESTA®
AQUATIC

**GYORSCSATLAKOZÓ,
STOPPAL**



R.s. leírás **45395** 24

FESTA
AQUATIC

CSAPCSATLAKOZÓ,
BELSŐMENETES



R.s. leírás 
45396 24



NEW



FESTA
AQUATIC

KERTI TÖMLŐ
PROFI



R.s.	leírás	
45372	1/2" 25 m	1
45373	1/2" 50 m	1
45374	3/4" 25 m	1
45375	3/4" 50 m	1
45376	1" 25 m	1
45377	1" 50 m	1



FESTA
AQUATIC

CSAPCSATLAKOZÓ,
BELSŐMENETES



R.s. leírás 
45397 24



FESTA
AQUATIC

BILLENŐ LOCSOLÓ, MŰANYAG

· 19 fúvóka 8 kadbolható (be/ki) öntöző fúvókával



R.s. leírás 
45398 6

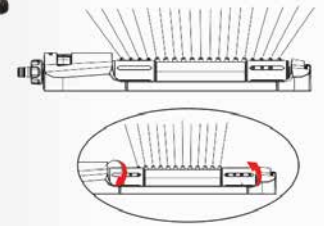

FESTA
AQUATIC

LOCSOLÓ, 3 FORGÓVAL

· állítható locsolókarok fúvókákkal



R.s. leírás 
45399 12



FESTA
AQUATIC

ELOSZTÓ

· könnyű vízszögér vezérlés



R.s. leírás 
45400 6



FESTA
AQUATIC

ELOSZTÓ

· könnyű vízszögér vezérlés



R.s. leírás 
45401 6

ROSA**LOCSOLÓPISZTOLY**

- 10 funkciós
- rögzíthető

0,7bar min
5,5bar max

R.s. leírás

45124

12

**ROSA****LOCSOLÓPISZTOLY**

- 10 funkciós
- rögzíthető
- könnyű vízszugár vezérlés

0,7bar min
5,5bar max

R.s. leírás

45125

12

**ROSA**

Watering system

ROSA**LOCSOLÓPISZTOLY**

- 7 funkciós
- rögzíthető

0,7bar min
5,5bar max

R.s. leírás

45126

12

**ROSA****LOCSOLÓPISZTOLY**

- 7 funkciós
- rögzíthető
- könnyű vízszugár vezérlés

0,7bar min
5,5bar max

R.s. leírás

45123

metal

12

**ROSA****LOCSOLÓPISZTOLY**

- 6 funkciós
- rögzíthető
- könnyű vízszugár vezérlés

0,7bar min
5,5bar max

R.s. leírás

45117

12

**ROSA****LOCSOLÓPISZTOLY**

- 6 funkciós
- rögzíthető
- könnyű vízszugár vezérlés

0,7bar min
5,5bar max

R.s. leírás

45118

fém

12

**ROSA****LOCSOLÓPISZTOLY**

- 5 funkciós
- rögzíthető
- könnyű vízszugár vezérlés

0,7bar min
5,5bar max

R.s. leírás

45110

12

**ROSA****LOCSOLÓPISZTOLY**

- Pisztolyrózsza
- könnyű vízszugár vezérlés

0,7bar min
5,5bar max

R.s. leírás

45116

12



ROSA

LOCSOLÓPISZTOLY

- fém
- rögzíthető
- könnyű vízsugár vezérlés

0,7bar min
5,5bar max

R.s. leírás 12  



ROSA

LOCSOLÓPISZTOLY

- rögzíthető
- könnyű vízsugár vezérlés

0,7bar min
5,5bar max

R.s. leírás 12  



ROSA

LOCSOLÓPISZTOLY

- fém
- rögzíthető
- könnyű vízsugár vezérlés

0,7bar min
5,5bar max

R.s. leírás 12  





ROSA

LOCSOLÓPISZTOLY KÉSZLET

- rögzíthető
- könnyű vízsugár vezérlés

0,7bar min
5,5bar max 1/2" 2x

R.s. leírás 12  





ROSA

LOCSOLÓPISZTOLY

- rögzíthető
- könnyű vízsugár vezérlés

0,7bar min
5,5bar max

R.s. leírás 12  



ROSA

LOCSOLÓPISZTOLY KÉSZLET

- 6 funkciós
- rögzíthető
- könnyű vízsugár vezérlés

0,7bar min
5,5bar max 1/2" 4x

R.s. leírás 12  





ROSA

SUGÁRCSŐ, ÁLLÍTHATÓ

- állítható vízsugár

10bar max 1"

R.s. leírás 48  



ROSA

SUGÁRCSŐ, TÖMLŐCSATLAKOZÓS, ÁLLÍTHATÓ

- stream lined
- classic connection

0,7bar min
5,5bar max

R.s. leírás 32  





ROSA

SUGÁRCSŐ, GYORSCSATLAKOZÓS, ÁLLÍTHATÓ

- állítható vízsugár

0,7bar min
5,5bar max

R.s. leírás 60  





ROSA

SUGÁRCSŐ KÉSZLET, 4 DB-OS

- állítható vízsugár

0,7bar min
5,5bar max 1/2" 4x

R.s. leírás 12  



ROSA

TÖMLŐ ÖSSZEKÖTŐ

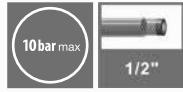

10 bar max 1/2" R.s. leírás 60

ROSA

GYORSCSATLAKOZÓ



10 bar max 1/2" R.s. leírás 60

ROSAGYORSCSATLAKOZÓ,
STOPPAL

10 bar max 1/2" R.s. leírás 60

ROSA

TÖMLŐ ÖSSZEKÖTŐ



10 bar max 1/2" R.s. leírás 60

MOQ 20

ROSA

GYORSCSATLAKOZÓ



10 bar max 1/2" R.s. leírás 60

MOQ 20

ROSAGYORSCSATLAKOZÓ STOPPOS,
KÍNÁLÓ DOBOZBAN

10 bar max 1/2" R.s. leírás 60

MOQ 20

ROSA

TÖMLŐ ÖSSZEKÖTŐ



10 bar max 3/4" R.s. leírás 60

ROSA

GYORSCSATLAKOZÓ



10 bar max 3/4" R.s. leírás 60

ROSAGYORSCSATLAKOZÓ,
STOPPAL

10 bar max 3/4" R.s. leírás 60

ROSATÖMLŐ ÖSSZEKÖTŐ,
KÍNÁLÓ DOBOZBAN

10 bar max 3/4" R.s. leírás 60

MOQ 20

ROSAGYORSCSATLAKOZÓ,
KÍNÁLÓ DOBOZBAN

10 bar max 3/4" R.s. leírás 60

MOQ 20

ROSAGYORSCSATLAKOZÓ STOPPOS,
KÍNÁLÓ DOBOZBAN

10 bar max 3/4" R.s. leírás 60

MOQ 20

ROSA

SZŰKÍTŐ



10 bar max 1/2" 3/4" R.s. leírás 60

ROSA

SZŰKÍTŐ



10 bar max 1" 3/4" R.s. leírás 48

ROSA

TÖMLŐ ÖSSZEKÖTŐ



10 bar max 1" R.s. leírás 48

ROSA

CSAPCSA-
TLAKOZÓ,
BELSŐMENETES



R.sz.	leírás	
45130	1/2" + 3/4"	60
45131	3/4" + 1"	60

ROSA

ADAPTER



R.sz.	leírás	
45217		48

ROSA

GYORSCSATLAKOZÓ



R.sz.	leírás	
45219		48

ROSA

CSAPCSATLAKOZÓ, BELSŐ-
MENETES, KÍNÁLÓ DOBOZBAN



R.sz.	leírás	
45289	1/2" + 3/4"	MOQ 20
45290	3/4" + 1"	MOQ 20

ROSA

CSATLAKOZÓ KÉSZLET

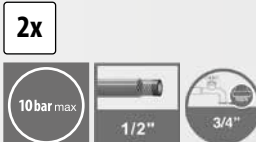

R.sz.	leírás	
45144		60

ROSA

CSAPCSATLAKOZÓ,
KÜLSŐMENETES

Egyszerű csatlakozódugó Szeleppel



R.sz.	leírás	
45135		60

ROSA

CSAPCSATLAKOZÓ,
KÜLSŐMENETES



R.sz.	leírás	
45133		60

ROSA

CSAPCSATLAKOZÓ,
BELSŐMENETES



R.sz.	leírás	
45132		60

ROSA

KUPLUNG CSATLAKOZÓ



R.sz.	leírás	
45136		60

ROSA

CSAPCSATLAKOZÓ, KÜLSŐ-
MENETES, KÍNÁLÓ DOBOZBAN

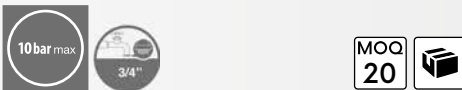

R.sz.	leírás	
45292		MOQ 20

ROSA

CSAPCSATLAKOZÓ, BELSŐ-
MENETES, KÍNÁLÓ DOBOZBAN

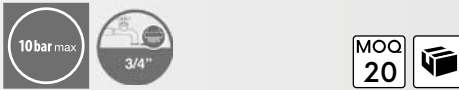

R.sz.	leírás	
45291		MOQ 20

ROSA

KUPLUNGCSATLAKOZÓ,
KÍNÁLÓ DOBOZBAN



R.sz.	leírás	
45293		MOQ 20

ROSA

„Y” ELÁGAZÓ

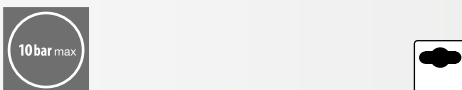

R.sz.	leírás	
45137		60

ROSA

ADAPTER

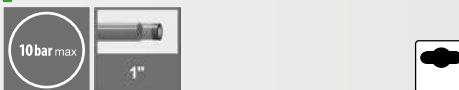

R.sz.	leírás	
45215		48

ROSA

CSAPCSATLAKOZÓ, BILINCCSEL



R.sz.	leírás	
45145		60

ROSA

KÉTUTAS
CSATLAKOZÓ

Elosztó szeleppel, 2 gyorscsatlakozó

0,7 bar min
5,5 bar max

R.s. leírás

45134



12



3/4"

ROSA

KÍNÁLÓ KÉSZLET

Csomag tartalma

45113	15 szt.	kom
45117	10 szt.	kom
45120	15 szt.	kom
45132	40 szt.	kom
45131	40 szt.	kom
45133	40 szt.	kom
45142	25 szt.	kom
45143	20 szt.	kom
45140	20 szt.	kom

225x

R.s. leírás

45146



ROSA

PULZÁLÓ
LOCSOLÓTALP, FORFI

impulse

0,7 bar min
5,5 bar max

R.s. leírás

45162



24



ROSA

LOCSOLÓTALP
8 FUNKCIÓS

8 function

0,7 bar min
5,5 bar max

R.s. leírás

45154



48



ROSA

LOCSOLÓ,
2 FORGÓVAL

rotary, 2 arms

0,7 bar min
5,5 bar max

R.s. leírás

45153



24



ROSA

LOCSOLÓ,
3 FORGÓVAL

rotary, 3 arms

0,7 bar min
5,5 bar max

R.s. leírás

45152



24



ROSA

BÍLLENŐ LOCSOLÓ,
MŰANYAG

17 jets ALU

0,7 bar min
5,5 bar max

ALU

R.s. leírás

45158



6



ROSA

LOCSOLÓPIRAMIS

pyramidal

0,7 bar min
5,5 bar max

R.s. leírás

45167



12



ROSA

LOCSOLÓTALP

0,7 bar min
5,5 bar max

3/4"

R.s. leírás

45155



24



ROSA

LOCSOLÓ, PULZÁLÓ,
ÁLLVÁNYOS

tripod

0,7 bar min
5,5 bar max

R.s. leírás

45163 impulse, tripod



20



ROSA

LOCSOLÓ, ESŐZTETŐ, LESZHÚRHATÓ

· plastic point

0,7 bar min
5,5 bar max

R.s. leírás

45160 25



ROSA

CSERÉPLOCSOLÓ

· cserép locsoló

0,7 bar min
5,5 bar max

R.s. leírás

45156 12



ROSA

IDŐZÍTŐ

· 0 - 120 min.

0,7 bar min
5,5 bar max

3/4"

R.s. leírás

45147 24



ROSA

LOCSOLÓ, PULZÁLÓ, RÉZ, MENETES

· brass

0,7 bar min
5,5 bar max

3/4"

R.s. leírás

45150 12



ROSA

LOCSOLÓ, PULZÁLÓ, MŰA., MENETES

0,7 bar min
5,5 bar max

3/4"

R.s. leírás

45151 12



ROSA

LOCSOLÓ, PULZÁLÓ, MŰA., LESZÚRHATÓ

0,7 bar min
5,5 bar max

3/4"

R.s. leírás

45168 plastic point 12
45169 metal point 12



ROSA

LOCSOLÓ, PULZÁLÓ, LESZÚRHATÓ

0,7 bar min
5,5 bar max

R.s. leírás

45161 plastic point 20



ROSA

LOCSOLÓ, FORGÓ, LESZÚRHATÓ

· 3 arms

0,7 bar min
5,5 bar max

3/4"

R.s. leírás

45164 plastic point 12



ROSA

LESZÚRÓ, FÉM

3/4" Zn

R.s. leírás

45159 12



ROSA

LESZÚRÓ MŰANYAG

3/4"

R.s. leírás

45179 12



ROSA

TÖMLŐVEZETŐ

R.s. leírás

45186 48



ROSA

SZAKASZOS LOCSOLÓ, FÉM

1"

R.s. leírás

45185 20



ROSA

SZAKASZOS LOCSOLÓ, FÉM

3/4"

R.s. leírás

45184 20

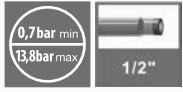

ROSA

TÖMLŐ
ÖSSZEKÖTŐR.s. leírás
45192

48

ROSA

GYORS-
CSATLAKOZÓR.s. leírás
45194

48

ROSA

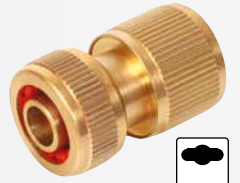
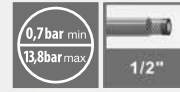
GYORS-
CSATLAKOZÓ,
STOPPALR.s. leírás
45190

48

ROSA

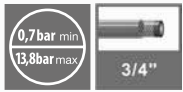
TÖMLŐ
ÖSSZEKÖTŐR.s. leírás
45193

48

ROSA

GYORS-
CSATLAKOZÓR.s. leírás
45195

48

ROSA

GYORS-
CSATLAKOZÓ,
STOPPALR.s. leírás
45191

48

ROSA

CSAP-
SATLAKOZÓR.s. leírás
45196

belsomenetes 1/2" + 3/4"

48

ROSA

CSAP-
SATLAKOZÓR.s. leírás
45197

belsomenetes 3/4"

48

ROSA

CSAP-
SATLAKOZÓR.s. leírás
45199

belsomenetes 1"

48

ROSA

CSAP-
SATLAKOZÓR.s. leírás
45198

belsomenetes 3/4 + 1"

48

ROSA

CSAP-
SATLAKOZÓR.s. leírás
45200

külsomenetes 3/4"

48

ROSA

SUGÁRCSO,
ÁLLÍTHATÓR.s. leírás
45206

állítható vízsugár

48

ROSA

ÖSSZEKÖTŐ

R.s. leírás
45203

2-utas elosztó

48

ROSA

HÁROMUTAS
ELOSZTÓR.s. leírás
45204

háromutas elosztó

48

TÖMLŐ
ÖSSZEKÖTŐR.s. leírás
45211

1", závit 1"

25

ROSA

„O” GYŰRŰ KÉSZLET

· Tételekhez
45110, 45111, 45118, 45120, 45121, 45123,
45125, 45126, 45130, 45131, 45132, 45134,
45135, 45152, 45153, 45154, 45155, 45156,
45162, 45177, 45178, 45180, 45196, 45197,
45198

R.s. leírás
45175

leírás

1

ROSA

„O” GYŰRŰ

50x

R.s. leírás
45187

leírás

1



NEW



ROSA
KERTI TÖMLŐ TISZTA



R.s.	leírás	
45342	1/2" 10 m	1
45343	1/2" 15 m	1
45344	1/2" 20 m	1
45345	1/2" 25 m	1
45346	1/2" 50 m	1
45341	3/4" 10 m	1
45347	3/4" 15 m	1
45348	3/4" 20 m	1
45349	3/4" 25 m	1
45351	3/4" 50 m	1
45352	1" 15 m	1
45353	1" 25 m	1
45354	1" 50 m	1

NEW



FESTA AQUATIC
KERTI TÖMLŐ PROFI



R.s.	leírás	
45372	1/2" 25 m	1
45373	1/2" 50 m	1
45374	3/4" 25 m	1
45375	3/4" 50 m	1
45376	1" 25 m	1
45377	1" 50 m	1

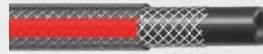

ROSA
SPIRÁL TÖMLŐ



R.s.	leírás	
45300	7,5 m	6
45301	15 m	8



ROSA
TÖMLŐTARTÓ, TALPAS



R.s.	leírás	
45178	1/2" 60 m	5



ROSA
TÖMLŐTARTÓ KOCSI, MŰANYAG



R.s.	leírás	
45183	1/2" 60 m	5



ROSA
TÖMLŐTARTÓ KOCSI, MŰANYAG



R.s.	leírás	
45177	1/2" 60 m	5

ROSA
TÖMLŐTARTÓ FALRA SZERELHETŐ



R.s.	leírás		
45182	1/2" 40 m	4	60

ROSA
TÖMLŐTARTÓ DOB

· hose included 1/2" 20 m



R.s.	leírás		
45176		1	



ROSA
TÖMLŐTARTÓ

R.s.	leírás	
45174		60



TÖMLŐHORDOZÓ
· kerti műanyag cső, 30 m, 1/2"

R.s.	leírás	
45350	Max. 20 kg	1



TÖMLŐ ÖSSZEKÖTŐ,
CSAPOS

R.sz.	leírás	
45220	1/2" szál 3/4"	10
45221	3/4" szál 1"	10
45222	1" szál 1"	10

CSAPCSATLAKOZÓ,
LAPOS

R.sz.	leírás	
45223	1/2" szál 3/4"	10
45224	3/4" szál 1"	10
45225	1" szál 1"	10

SZÜKÍTŐ,
CSAPOS

R.sz.	leírás	
45226	1/2"- 3/4" szál 1"	10
45227	1" - 3/4" szál 1"	10
45228	1" - 1/2" szál 1"	10

SUGÁRCSŐ,
CSAPOS

R.sz.	leírás	
45229		10



R.sz.	diameter	
45603	16 - 25 mm	2
45604	20 - 32 mm	2
45605	25 - 40 mm	2
45606	30 - 45 mm	2
45607	32 - 50 mm	2
45608	40 - 60 mm	2
45609	50 - 70 mm	2
45610	60 - 80 mm	2
45611	70 - 90 mm	2
45612	80 - 100 mm	2
45613	90 - 110 mm	2
45614	100 - 120 mm	2
45615	110 - 130 mm	2
45616	120 - 140 mm	2
45617	130 - 150 mm	2
45618	140 - 160 mm	2
45619	150 - 170 mm	2



R.sz.	diameter	szélesség	
45623	16 - 25 mm	9 mm	2
45624	20 - 32 mm	9 mm	2
45625	25 - 40 mm	12 mm	2
45626	30 - 45 mm	12 mm	2
45627	32 - 50 mm	12 mm	2
45628	40 - 60 mm	12 mm	2
45629	50 - 70 mm	12 mm	2
45630	60 - 80 mm	12 mm	2
45631	70 - 90 mm	12 mm	2
45632	80 - 100 mm	12 mm	2
45633	90 - 110 mm	12 mm	2
45634	100 - 120 mm	12 mm	2
45635	110 - 130 mm	12 mm	2
45636	120 - 140 mm	12 mm	2
45637	130 - 150 mm	12 mm	2
45638	140 - 160 mm	12 mm	2
45639	150 - 170 mm	12 mm	2

TÖMLŐ BILINCS

Zn **MOQ 2**

R.sz.	diameter	
45600	8 - 12 mm	2
45601	10 - 16 mm	2
45602	12 - 20 mm	2

TÖMLŐ BILINCS

INOX **MOQ 2**

R.sz.	diameter	szélesség	
45620	8 - 12 mm	9 mm	2
45621	10 - 16 mm	9 mm	2
45622	12 - 20 mm	9 mm	2

KERTI CSAP

R.sz.	
45105	8



KERTI CSAP

R.sz.	leírás	
45100	1/2"	12
45101	3/4"	10
45102	1"	6



KERTI GOLYÓS CSAP

R.sz.	leírás	
45106	1/2"	12
45107	3/4"	10
45108	1"	8

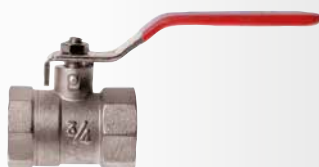

ÖNTÖZŐKANNA

MADE IN
EU

R.sz.	leírás	
45280	2,5 l	10
45283	5 l	10
45285	10 l	10
45286	12 l	10
45287	15 l	10



FALI CSAP DERÉKSZÖGŰ

R.sz.	leírás	
45104	1/2" x 3/8"	10





FESTA
PERMETEZŐ

max. nyomás	2,5 Bar
kötet	12 l
permetező tömlő hossza	3 m
méretek	32 x 25 x 59 cm

R.sz.	leírás	
45249	kézi permetező 12 l	1

FESTA
PERMETEZŐ

R.sz.	leírás	
45247	12 l	1
45248	16 l	1
R.sz.	leírás	
45263	tartalék tömlő	1
45251	tartalék készlet	1
45254	pótfúvóka	1
45257	tartalék fogantyú	1
45261	Pótoszlop - 370 mm	1
45267	Pótoszlop 45 - 250 cm	1
45268	Pótoszlop 65 - 260 cm	1

FESTA
KÉZI PERMETEZŐ

R.sz.	leírás	
45244	3 l	6
45245	5 l	6
45246	8 l	6
R.sz.	leírás	
45262	tartalék tömlő	1
45250	tartalék készlet	1
45253	pótfúvóka	1
45256	tartalék fogantyú	1
45260	pótoszlop - 370 mm	1

• mert: 45244, 45245, 45246



TELESZKOPÓS PERMETEZŐ CSŐ

R.sz.	type		
45267	45 - 250 cm	inox	1
45268	65 - 260 cm	fiberglass	1

93 - 250 cm



TELESZKOPÓS PERMETEZŐ CSŐ

R.sz.	leírás	
45269		1



TARTALÉK TÖMLŐ PERMETEZŐHÖZ

R.sz.	type	
45263	permetezőhöz 45247, 45248	1
45262	permetezőhöz 45244, 45245, 45246	1



GYOMÍRTÓ HARANG

R.sz.	size	dugósc	szélesség	wysokosc	
45265	kicsi	230 mm	90 mm	130 mm	1
45266	nagy	370 mm	140 mm	200 mm	1



FESTA

KÉZI PERMETEZŐ



R.sz.	type	
45242	1,5 l	20
45241	2 l	20

KÉZI PERMETEZŐ



R.sz.	type	
45239	0,5 l	1
45240	0,7 l	1

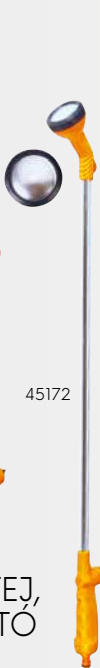

ROSA

KERTI ZUHANYZÓ, LESZÚRHATÓ



R.sz.	leírás	
45171	adjustable	12

ROSA

KERTI ZUHANYZÓ, 3 LÁBAS



R.sz.	leírás	
45170	tripod	6

ROSA

LOCSOLÓ FEJ, HOSSZABBÍTÓ



R.sz.	leírás	
45172	záróval	12
45173	10 funkció	12



FESTA[®]

system click
ON - OFF



system click
ON - OFF



system click
ON - OFF

FESTA

MŰANYAG GEREPLYE

R.sz.	lécek száma	szélesség	wysokosc	
45327	13	240 mm	200 mm	12

FESTA

MŰANYAG GEREPLYE

R.sz.	lécek száma	szélesség	
45325	12	410 mm	12



system click
ON - OFF



system click
ON - OFF

FESTA

MŰANYAG GEREPLYE

R.sz.	lécek száma	szélesség	wysokosc	
45328	23	480 mm	280 mm	12

FESTA

MŰANYAG GEREPLYE

R.sz.	lécek száma	szélesség	
45326	18	580 mm	12



system click
ON - OFF



system click
ON - OFF

FESTA

MŰANYAG GEREPLYE

R.sz.	lécek száma	szélesség	wysokosc	
45329	35	760 mm	310 mm	1

FESTA

BETONSEPRŰ

R.sz.	leírás	
45323	37 cm	16

FESTA

NYÉL ALU

ALU



system click
ON - OFF

R.sz.	leírás	
45330	161 cm	24
45331	100 cm	24

**FESTA**

LOMBSEPRŰ,
FÉM,
ÁLLÍTHATÓ



Zn

R.sz.	lécek száma	dugósc	
44965	15	200 - 590 mm	12

LOMBSEPRŰ, FÉM, ÁLLÍTHATÓ



Zn

R.sz.	lécek száma	waga	dugósc	
45050	15	1200 g	200 - 590 mm	25

FESTA

LOMBSEPRŰ, FÉM
· spring steel



R.sz.	szélesség	lécek száma	
45071	55 cm	22	1

FESTA

LOMBSEPRŰ,
FA NYÉLLEL

MOQ
3

R.sz.	szélesség	fogantyú hossza	
61150	55 cm	160 cm	3



LOMBSEPRŰ,
FA NYÉLLEL

MOQ
3

LOMBSEPRŰ, FÉM

R.sz.	szélesség	lécek száma	
45051	40 cm	22	60

R.sz.	szélesség	fogantyú hossza	
61130	40 cm	160 cm	3



LOMBSEPRŰ,
FA NYÉLLEL

MOQ
3

LOMBSEPRŰ, FÉM

R.sz.	szélesség	lécek száma	
45052	45 cm	22	36

R.sz.	szélesség	fogantyú hossza	
61131	45 cm	160 cm	3

MŰANYAG LOMBSEPRŰ



R.s.	szélesség	lécek száma	
45320	60 cm	24	10

MŰANYAG LOMBSEPRŰ,
FA NYÉLLEL



R.s.	szélesség	lécek száma	fogantyú hossza	
61132	60 cm	24	160 cm	3

MOQ
3

MŰANYAG LOMBSEPRŰ



R.s.	szélesség	lécek száma	
45055	50 cm	22	10

MŰANYAG LOMBSEPRŰ,
FA NYÉLLEL



R.s.	szélesség	lécek száma	fogantyú hossza	
61133	50 cm	22	160 cm	3

MOQ
3

MŰANYAG LOMBSEPRŰ



R.s.	szélesség	lécek száma	
45321	40 cm	23	20

MŰANYAG LOMBSEPRŰ,
FA NYÉLLEL



R.s.	lécek száma	fogantyú hossza	
61134	23	160 cm	3

MOQ
3

MŰANYAG LOMBSEPRŰ



R.s.	szélesség	lécek száma	
45054	40 cm	23	10

MŰANYAG LOMBSEPRŰ,
FA NYÉLLEL



R.s.	szélesség	lécek száma	fogantyú hossza	
61135	40 cm	23	160 cm	3

MOQ
3

MŰANYAG GEREPLYE



R.s.	szélesség	lécek száma	
45053	58 cm	16	35

MŰANYAG GEREPLYE,
FA NYÉLLEL



R.s.	szélesség	lécek száma	fogantyú hossza	
61141	58 cm	16	160 cm	3

MOQ
3

MŰANYAG
GEREBLYE

R.sz.	szélesség	fogak száma	
45070	41 cm	14	4

MŰANYAG
GEREBLYE,
FA NYÉLLEL

R.sz.	szélesség	fogak száma	fogantyú hossza	
61142	41 cm	14	160 cm	3

MOQ
3

GEREBLYE FÉM

R.sz.	szélesség	fogak száma	
61030	24 cm	10	24
61031	29 cm	12	24
61032	34 cm	14	24
61033	40 cm	16	24

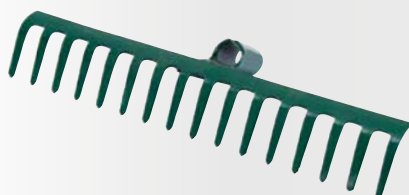
GEREBLYE, FÉM,
FA NYÉLLEL

R.sz.	szélesség	fogak száma	fogantyú hossza	
61060	24 cm	10	160 cm	3
61061	29 cm	12	160 cm	3
61062	34 cm	14	160 cm	3
61063	40 cm	16	160 cm	3

MOQ
3GEREBLYE
FÉM

· kalapács festék

R.sz.	szélesség	fogak száma	
61045	30 cm	12	25
61046	39 cm	14	25
61047	45 cm	16	25

GEREBLYE, FÉM,
FA NYÉLLEL

· kalapács festék

R.sz.	szélesség	fogak száma	fogantyú hossza	
61143	30 cm	12	160 cm	3
61144	39 cm	14	160 cm	3
61145	45 cm	16	160 cm	3

MOQ
3GYEP
SZELLŐZTETŐ

R.sz.	szélesség	fogak száma	
61048	35 cm	11 21	12

GYEP SZELLŐZTETŐ,
FA NYÉLLEL

R.sz.	szélesség	fogak száma	fogantyú hossza	
61146	35 cm	11 21	160 cm	3

MOQ
3GEREBLYE, FÉM,
ÜVEGSZÁLAS
NYÉLLEL

R.sz.	szélesség	fogak száma	fogantyú hossza	
61034	34 cm	14	160 cm	3

MOQ
3

FESTA HEGYES ÁSÓ



R.s.	leírás	fogantyú hossza	
61006	19 x 28 cm	120 cm	5

FESTA HEGYES ÁSÓ

· Alkalmas üvegházban történő munkához



R.s.	leírás	fogantyú hossza	
61008	19 x 28 cm	85 cm	5

FESTA ÁSÓ, LAPOS



R.s.	leírás	fogantyú hossza	
61005	20 x 29 cm	120 cm	5

FESTA®



FESTA ÁSÓ, LAPOS

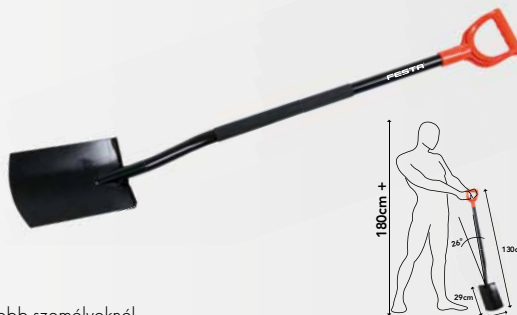

· vagy 180 cm-nél nagyobb személyeknél

R.s.	leírás	fogantyú hossza	
61157	20 x 29 cm	130 cm	5

FESTA HEGYES ÁSÓ



· vagy 180 cm-nél nagyobb személyeknél

R.s.	leírás	fogantyú hossza	
61158	19 x 28 cm	130 cm	5

FESTA LAPÁT



R.s.	leírás	fogantyú hossza	
61155	24 x 29 cm	120 cm	5

FESTA VILLA



R.s.	leírás	fogantyú hossza	
61156	19 x 28 cm	130 cm	5

FESTA VILLA



R.s.	leírás	fogantyú hossza	
61007	18 x 28 cm	130 cm	5

VILLA



R.s.	leírás	fogantyú hossza	
61010	18 x 30 cm	95 cm	12

ÁSÓ HEGYES ÜVEGSZÁLAS NYÉLLEL



R.s.	leírás	fogantyú hossza	
61029	19 x 30 cm	105 cm	12

LAPÁT ÜVEGSZÁLAS NYÉLLEL



R.s.	leírás	fogantyú hossza	
61015	19 x 30 cm	105 cm	12



LAPÁT ALU, FA NYÉLLEL

· bükk nyél

ALU

MOQ
3

R.sz.	leírás	fogantyú hossza	
61057	26 x 29 cm	130 cm	3
61056	34 x 30 cm	130 cm	3



LAPÁT ALU

ALU

R.sz.	leírás	
61026	26 x 29 cm	10
61025	34 x 30 cm	10



LAPÁT FA NYÉLLEL

MOQ
3

R.sz.	leírás	fogantyú hossza	
61089	35 x 35 cm	130 cm	3



LAPÁT

R.sz.	leírás	
61021	35 x 35 cm	10



ÁSÓLAPÁT FA NYÉLLEL

· kalapács festék
· Bükk fa nyél

MOQ
3

R.sz.	leírás	fogantyú hossza	
61050	26 x 28 cm	130 cm	3

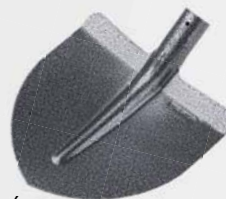

ÁSÓLAPÁT

· kalapács festék

R.sz.	leírás	
61000	26 x 28 cm	12



ÁSÓLAPÁT FA NYÉLLEL

· Bükk fogantyú

MOQ
3

R.sz.	leírás	fogantyú hossza	
61088	26 x 28 cm	130 cm	3



ÁSÓLAPÁT

R.sz.	leírás	
61020	26 x 28 cm	12



LAPÁT FA NYÉLLEL

· kalapács festék
· Bükk fa nyél

MOQ
3

R.sz.	leírás	fogantyú hossza	
61051	24 x 29 cm	130 cm	3

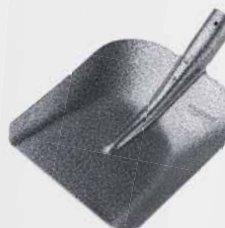

LAPÁT

· kalapács festék

R.sz.	leírás	
61001	24 x 29 cm	12





LAPÁT

R.sz.	leírás	
61022	24 x 29 cm	12



LAPÁT FA NYÉLLEL

· Bükk fa nyél

MOQ
3

R.sz.	leírás	fogantyú hossza	
61090	24 x 29 cm	130 cm	3
61053	24 x 29 cm	130 cm "T" fogantyú	3



HOLSTEIN LAPÁT

R.sz.	leírás	
61058	25 x 27 cm	12



HOLSTEIN LAPÁT FA NYÉLLEL

· Bükk fa nyél

MOQ
3

R.sz.	leírás	fogantyú hossza	
61059	25 x 27 cm	130 cm	3



LAPÁT

· kalapács festék

R.sz.	leírás	
61002	19 x 27 cm	12



LAPÁT FA NYÉLLEL

· kalapács festék
· Bükk fa nyél

MOQ
3

R.sz.	leírás	fogantyú hossza	
61052	19 x 27 cm	130 cm	3



LAPÁT

R.sz.	leírás	
61024	19 x 27 cm	12



LAPÁT FA NYÉLLEL

MOQ
3

R.sz.	leírás	fogantyú hossza	
61054	19 x 27 cm	130 cm	3



MŰANYAG LAPÁT

R.sz.	leírás	
61027	24 x 26 cm	12



ÁSÓ HEGYES, FA NYÉLLEL

· kalapács festék

MOQ
3

R.s.	leírás	fogantyú hossza	MOQ
61161	22 x 30 cm	90 cm	3



ÁSÓ HEGYES

· kalapács festék

R.s.	leírás	MOQ
61004	22 x 30 cm	12



ÁSÓ HEGYES, FA NYÉLLEL

MOQ
3

R.s.	leírás	fogantyú hossza	MOQ
61097	19 x 30 cm	90 cm	3



ÁSÓ LEMEZ

R.s.	leírás	MOQ
61019	22 x 30 cm	12



KOVÁCSOLT ÁSÓ, FA NYÉLLEL

R.s.	leírás	fogantyú hossza	MOQ
61162	22 x 25 cm	90 cm	3
61223	fogantyú	90 cm	1



KOVÁCSOLT ÁSÓ

R.s.	leírás	MOQ
61013	22 x 25 cm	12



ÁSÓ ÍVES, FA NYÉLLEL

· kalapács festék

MOQ
3

R.s.	leírás	fogantyú hossza	MOQ
61163	21 x 30 cm	90 cm	3



ÁSÓ ÍVES

· kalapács festék

R.s.	leírás	MOQ
61003	21 x 30 cm	12



ÁSÓ FEKETE ÍVES

R.s.	leírás	
61018	21 x 30 cm	12



ÁSÓ ÍVES, FA NYÉLLEL

MOQ
3

R.s.	leírás	fogantyú hossza	
61098	21 x 30 cm	90 cm	3



FAISKOLAI LAPÁT

R.s.	leírás	
61014	14 x 37 cm	12



FAISKOLAI LAPÁT, FA NYÉLLEL

R.s.	leírás	fogantyú hossza	
61164	14 x 37 cm	90 cm	MOQ 3
61203	fa nyél	90 cm	1



VILLA

R.s.	leírás	
61009	20 x 32 cm	12



VILLA FA NYÉLLEL

MOQ
3

R.s.	leírás	fogantyú hossza	
61165	20 x 32 cm	90 cm	3



KOVÁCSOLT ÁSÓVILLA

R.s.	leírás	
61012	22 x 30 cm	12



KOVÁCSOLT ÁSÓVILLA, FA NYÉLLEL

R.s.	leírás	fogantyú hossza	
61166	22 x 30 cm	90 cm	MOQ 3
61222	fa nyél	90 cm	1



KOVÁCSOLT VILLA

R.s.	leírás	
61044	20 x 30 cm	12



KOVÁCSOLT VILLA, FA NYÉLLEL

R.s.	leírás	fogantyú hossza	
61028	20 x 30 cm	90 cm	MOQ 3
61209	fa nyél	90 cm	1



KOVÁCSOLT KAPA, HEGYES, FA NYÉLLEL

R.sz.	leírás	fogantyú hossza	MOQ	3
61111	0,4 kg	120 cm	MOQ	3
61112	0,6 kg	120 cm	MOQ	3
61224	fa nyél	120 cm		1



KOVÁCSOLT RÉPA KAPA, FA NYÉLLEL

R.sz.	leírás	fogantyú hossza	MOQ	3
61114	0,6 kg	120 cm	MOQ	3
61224	fa nyél	120 cm		1



IRTÓKAPA, FA NYÉLLEL

MOQ 3

R.sz.	leírás	fogantyú hossza	MOQ	3
61290	75 mm	120 cm		3
61291	125 mm	120 cm		3
61292	175 mm	120 cm		3



KAPA, HEGYES, FA NYÉLLEL

MOQ 3

R.sz.	leírás	fogantyú hossza	MOQ	3
61293	140 mm	120 cm		3



CSÁKÁNY FA NYÉLLEL

MOQ 3

R.sz.	leírás	fogantyú hossza	MOQ	3
61121	1,5 kg	95 cm		3
61042	2,5 kg	95 cm		3

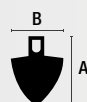

KAPA HEGYES

R.sz.	leírás	A	B	MOQ	3
61035	0,4 kg	180 mm	125 mm		1
61036	0,6 kg	230 mm	160 mm		30

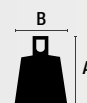

RÉPA KAPA

R.sz.	leírás	A	B	MOQ	3
61038	0,6 kg	165 mm	135 mm		20



IRTÓKAPA

R.sz.	leírás	MOQ	3
61067	75 mm		1
61068	125 mm		1
61069	175 mm		1

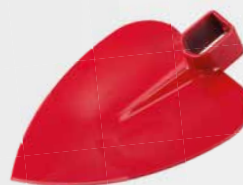

KAPA HEGYES

R.sz.	leírás	MOQ	3
61070	140 mm		40



CSÁKÁNY

R.sz.	leírás	MOQ	3
61120	1,5 kg		6
61040	2,5 kg		6



FESTA
HÓLAPÁT



R.s.	leírás	
60006	46 x 34 cm	12
60206	46 x 34 cm, összeszerelt	1

FESTA
HÓLAPÁT



R.s.	leírás	
60008	50 x 34 cm	12
60208	50 x 34 cm, összeszerelt	1

HÓLAPÁT



MADE IN EU

R.s.	leírás	
60001	48 x 40 cm	10
60201	48 x 40 cm, összeszerelt	1

HÓLAPÁT



ALU

R.s.	leírás	
60012	50 x 38 cm	12
60212	50 x 38 cm, összeszerelt	1



JÉGTÖRŐ

R.s.	leírás		MOQ
60022	20 cm	3	3

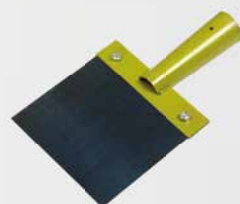

JÉGTÖRŐ

R.s.	leírás	
60018	15 cm	20
60019	20 cm	24
60020	30 cm	20
61201	fogantyú 130 cm	10



ÚTSZORÓ SÓ

R.s.	leírás	
43300	10 kg	1
43301	25 kg	1



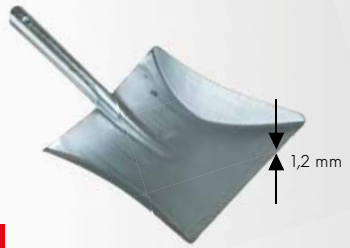

FESTA

SZEMÉTLAPÁT

R.sz.	leírás	
52176	22 x 23 cm	24

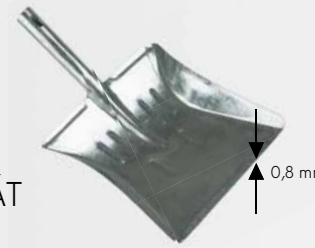

SZEMÉTLAPÁT

Zn

R.sz.	leírás	
52175	22 x 23 cm	50



SZEMÉTLAPÁT ÉS SEPRŰ

MADE IN EU

R.sz.	leírás	
52168		26



SZEMÉTLAPÁT ÉS SEPRŰ

MADE IN EU

R.sz.	leírás	
52173		26



ACÉLKEFE FA NYÉLLEL, FUGA TISZTÍTÁSHOZ

R.sz.	fogantyú hossza	
52198	140 cm	1



SEPRŰ

MADE IN EU

R.sz.	leírás	
52119	29 cm	24



BETONSEPRŰ FA NYÉLLEL

MADE IN EU

MOQ 3

R.sz.	leírás	
52197	30 cm 120 cm fa	3



BETONSEPRŰ

MADE IN EU

R.sz.	leírás	
52108	30 cm fekete	25
61172	nyél 120 cm fekete	1



BETONSEPRŰ FA NYÉLLEL

R.sz.	leírás	
52135	145 cm 5x varrva	1



system click ON - OFF

FESTA

BETONSEPRŰ

R.sz.	leírás	
45323	37 cm	16





BETONSEPRŰ



R.sz.	leírás	
52101	30 cm	10
52102	40 cm	10
52103	50 cm	10
52104	60 cm	10
52105	80 cm	10



BETONSEPRŰ FA NYÉLLEL



R.sz.	leírás	fogantyú hossza	
52190	30 cm	150 cm	3
52191	40 cm	150 cm	3
52192	50 cm	150 cm	3
52193	60 cm	150 cm	3
52194	80 cm	150 cm	3

MOQ
3



BETONSEPRŰ



R.sz.	leírás	
52160	40 cm	10
52161	50 cm	10
52162	60 cm	10
52163	70 cm	10
52164	80 cm	10



BETONSEPRŰ FA NYÉLLEL



R.sz.	leírás	fogantyú hossza	
52185	40 cm	150 cm	3
52186	50 cm	150 cm	3
52187	60 cm	150 cm	3
52188	70 cm	150 cm	3
52189	80 cm	150 cm	3

MOQ
3



PARTVIS



R.sz.	leírás	
52114	28 cm fekete	1



PARTVIS FA NYÉLLEL



R.sz.	leírás	fogantyú hossza	
52116	28 cm	130 cm	3

MOQ
3



PARTVIS



R.sz.	leírás	
52113	30 cm fekete	26
52115	30 cm menet nélkül	26



PARTVIS FA NYÉLLEL



R.sz.	leírás	fogantyú hossza	
52195	30 cm 150 cm fa	3	
52196	30 cm 130 cm ALU	3	

MOQ
3



LEHÚZÓGUMI

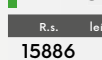

R.sz.	leírás	
15886	450 mm nyé Ø 23 mm	48
15887	600 mm nyé Ø 23 mm	48
15888	750 mm nyé Ø 23 mm	32



ÚTTEŠT SEPRŰ



R.sz.	leírás	
52109	25 cm 120 cm fa	12



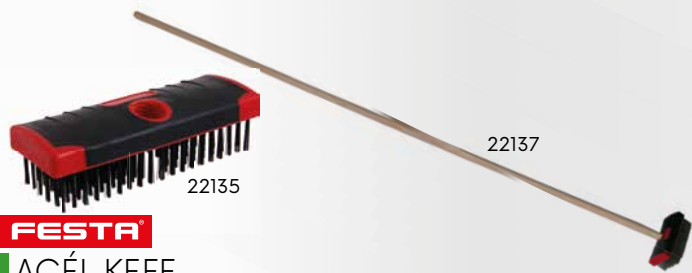

FESTA ACÉL KEFE

R.sz.	leírás		
22135	6 x 19 cm fogantyú nélkül	8	
22137	6 x 19 cm fogantyúval 140 cm	MOQ 3	



FESTA NYLON KEFE

R.sz.	leírás		
22136	6 x 19 cm fogantyú nélkül	8	
22138	6 x 19 cm fogantyúval 140 cm	MOQ 3	



FELMOSÓ MOP

R.sz.	leírás	
52110	30 cm	16



TARTALÉK MOP

R.sz.	leírás	
52111	30 cm	1

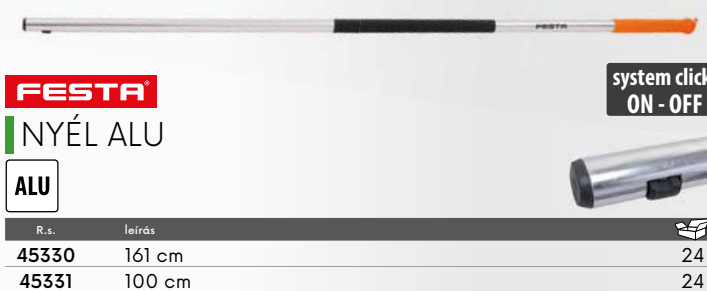

FESTA NYÉL ALU

R.sz.	leírás	
45330	161 cm	24
45331	100 cm	24



NYÉL ALU MADE IN EU

R.sz.	leírás	
52126	130 cm, cérna	1



MENETES NYÉL

R.sz.	leírás	
61172	120 cm fa návkészlet	1
61192	150 cm fa návkészlet for 52195	1
61193	150 cm fa návkészlet for 52185 - 94	1
61194	140 cm fa návkészlet	1

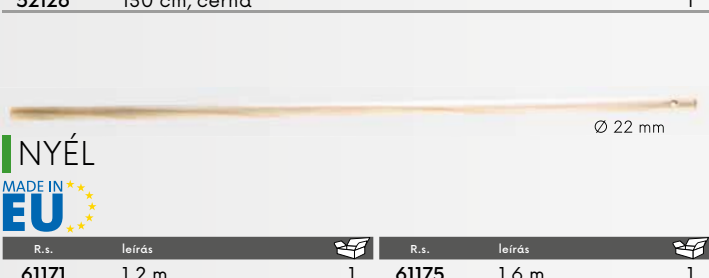

NYÉL MADE IN EU

R.sz.	leírás		R.sz.	leírás	
61171	1,2 m	1	61175	1,6 m	1
61173	1,4 m	1	61176	1,7 m	1
61174	1,5 m	1	61177	1,8 m	1

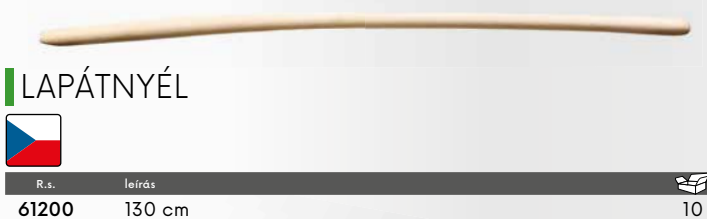

LAPÁTNYÉL

R.sz.	leírás	
61200	130 cm	10



LAPÁTNYÉL

R.sz.	leírás	
61201	130 cm, egyenes	10



ÁSÓNYÉL „T” FOGANTYÚ

R.sz.	leírás	
61208	90 cm	10



„T” LAPÁTNYÉL

R.sz.	leírás	
61202	130 cm, egyenes	10

LOMBSEPRŰ NYÉL



R.sz.	leírás	
61215	160 cm	10

CSÁKÁNY NYÉL



R.sz.	leírás	
61204	95 cm, szűk (for 61120)	10
61205	95 cm	10

GEREBLYE NYÉL



R.sz.	leírás	
61195	120 cm	10

LOMBSEPRŰNYÉL



R.sz.	leírás	vhodné for	
61250	160 cm	45051, 61048	20
61251	160 cm	45052	20
61252	160 cm	45320	20
61253	160 cm	45053	20
61254	160 cm	45054	20
61255	160 cm	45070	20
61256	160 cm	45055	20



ÁSÓNYÉL „Y” FOGANTYÚ



R.sz.	leírás	
61207	100 cm	10

KAPA NYÉL



R.sz.	leírás	
61219	120 cm	10

GEREBLYE NYÉL



R.sz.	leírás	
61183	150 cm	10
61184	160 cm	10
61189	170 cm	10
61190	180 cm	10



„Y” FOGANTYÚ

R.sz.	leírás	
61230		10

61079



120 cm

80 cm

No.	
61005	15
61006	15
61050	15
61051	15
61052	15
61079	1
61097	15
61098	15

61077



• Szemléltető fotó

BEMUTATÓ ÁLLVÁNY LAPÁT ÉS ÁSÓ

R.sz.	leírás	
61077	állvány ásónak és lapátnak	1
61079	állvány raklap	1

KERTI SZERSZÁM TARTÓ

5x

R.sz.	leírás	
51184		12

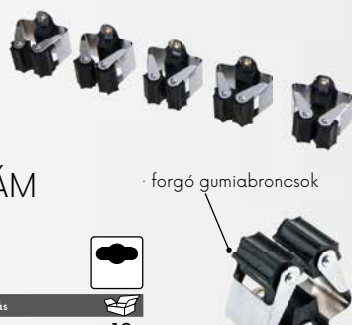

· forgó gumiabroncsok



KERTI SZERSZÁM TARTÓ

R.sz.	leírás	
51185	45 cm	15



• Szemléltető fotó



SZÚNYOGHÁLÓ PE MŰANYAG

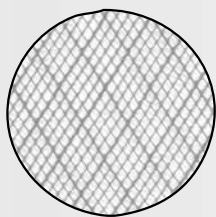

R.sz.	leírás	
40100	1 x 25 m - PE fehér	1
40120	1,2 x 25 m - PE fehér	1

SZÚNYOGHÁLÓ

ALU **Zn**

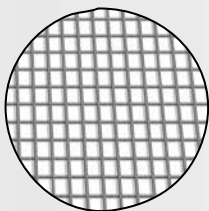

R.sz.	leírás	
42101	1 x 30 m - ALUMINIUM	2
42103	1 x 30 m - horganyzott Ø huzal	2

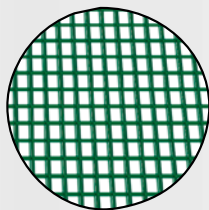

SZÚNYOGHÁLÓ FÉM FESTETT



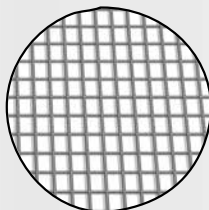

R.sz.	leírás	
42102	1 x 30 m - Zöld bevonatú acél Ø huzal	2



SZÚNYOGHÁLÓ ÜVEGSZÁLAS



R.sz.	leírás		
41083	0,8 x 30 m	fehér	6
41103	1 x 30 m	fehér	6
41123	1,2 x 30 m	fehér	6
41153	1,5 x 30 m	fehér	6

R.sz.	leírás		
41082	0,8 x 30 m	fehér-szürke	6
41102	1 x 30 m	fehér-szürke	6
41122	1,2 x 30 m	fehér-szürke	6
41152	1,5 x 30 m	fehér-szürke	6

R.sz.	leírás		
41050	0,5 x 30 m	szürke	6
41080	0,8 x 30 m	szürke	6
41100	1 x 30 m	szürke	6
41120	1,2 x 30 m	szürke	6
41150	1,5 x 30 m	szürke	6

R.sz.	leírás		
41081	0,8 x 30 m	fekete	6
41101	1 x 30 m	fekete	6
41121	1,2 x 30 m	fekete	6
41151	1,5 x 30 m	fekete	6





SZÚNYOGHÁLÓ FEHÉR



R.sz.	leírás		
40050	150 x 130 cm	5,6 m	10
40052	150 x 180 cm	6,6 m	10
40054	150 x 90 cm	4,8 m	10
40056	220 x 75 cm 2 db	5,8 m	10



SZÚNYOGHÁLÓ SZÜRKE



R.sz.	leírás		
40051	150 x 130 cm	5,6 m	10
40053	150 x 180 cm	6,6 m	10
40055	150 x 90 cm	4,8 m	10



SZÚNYOGHÁLÓ FEKETE



R.sz.	leírás		
40057	150 x 130 cm	5,6 m	10
40058	150 x 180 cm	6,6 m	10
40059	150 x 90 cm	4,8 m	10



TÉPŐZÁR

R.sz.	leírás	
40060	9 mm 7 m	1



SZÚNYOGHÁLÓ AJTÓRA, MÁGNESES – ANTRACIT



R.sz.	leírás	
40077	100 x 220 cm	1



SZÚNYOGHÁLÓ 4 LAMELLÁS

változó méretű 60 - 120 cm

R.sz.	leírás		
40075	4 x 35 x 220 cm fehér		20
40076	4 x 35 x 220 cm fekete		20

DRÓTHÁLÓ HATSZÖG, ZINC

Zn



R.sz.	leírás	
42150	13 0,7 x 1000 mm - 50 m	1
42151	16 0,7 x 1000 mm - 50 m	1
42152	20 0,7 x 1000 mm - 50 m	1
42153	25 0,8 x 1000 mm - 50 m	1

DRÓTHÁLÓ HATSZÖG, ZINC

Zn



R.sz.	leírás	
42155	13 0,7 x 1000 mm - 50 m	1
42156	16 0,7 x 1000 mm - 50 m	1
42157	20 0,7 x 1000 mm - 50 m	1
42158	25 0,8 x 1000 mm - 50 m	1

DRÓTHÁLÓ HATSZÖG, MŰANYAG

Zn



R.sz.	leírás	
42160	13 1 x 1000 mm - 25 m	1
42161	16 1 x 1000 mm - 25 m	1
42162	20 1 x 1000 mm - 25 m	1
42163	25 1 x 1000 mm - 25 m	1

DÍSZ DRÓTKERÍTÉS PVC



R.sz.	eye size	Ø huzal	wysokosc	length	
42175	15 x 9 mm	2 mm	40 cm	25 m	1
42176	15 x 9 mm	2 mm	65 cm	25 m	1
42177	15 x 9 mm	2 mm	90 cm	25 m	1
42178	15 x 9 mm	2 mm	120 cm	25 m	1
42179	15 x 9 mm	2 mm	25 cm	25 m	1



DRÓTHÁLÓ
NÉGYZET,
ZINC

140 g/m² UV STABLE

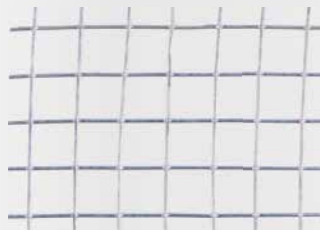

R.sz.	leírás	R.sz.	leírás
42185	6 0,65 x 1000 mm - 25 m	42174	25 1,4 x 1000 mm - 25 m
42170	10 0,8 x 1000 mm - 25 m	42186	13 1,05 x 1000 mm - 25 m
42171	13 0,8 x 1000 mm - 25 m	42187	25 2,0 x 1000 mm - 25 m
42172	16 1,2 x 1000 mm - 25 m	42188	50 2,0 x 1000 mm - 25 m
42173	19 1,4 x 1000 mm - 25 m		

KERÍTÉSFONAT,
PVC BEVONAT, ZÖLD

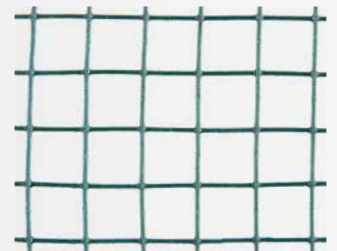

R.sz.	leírás	
42180	13 1,2 x 1000 mm - 25 m	1
42181	16 1,2 x 1000 mm - 25 m	1
42182	25 2,3 x 1000 mm - 25 m	1

CSIRKE HÁLÓ

MADE IN EU



R.sz.	leírás	
45570	2 x 5 m 18 x 18 mm	45
45571	2 x 10 m 18 x 18 mm	28
45572	4 x 5 m 18 x 18 mm	24
45573	4 x 10 m 18 x 18 mm	15

BIZTONSÁGI
KERÍTÉS

140 g/m² UV STABLE

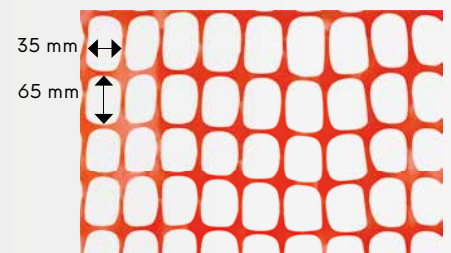

R.sz.	leírás	
42190	1,2 x 50 m HDPE 140g/m ²	1

DRÓTHÁLÓ RABIC

Zn



R.sz.	leírás	
42312	1 m 50 bm, 16 x 16 mm	1

FATÖRZS
VÉDŐHÁLÓ

Önzáró

3x MADE IN EU



R.sz.	leírás	
45580	Ø 11 x 80 cm	1



KÖTŐZÓDRÓT

Zn

R.s.	Ø huzal	vezeték hossza	
42203	0,6 mm	30 m	50



KÖTŐZÓDRÓT

R.s.	Ø huzal	vezeték hossza	powlekanie	
42201	0,6 mm	30 m	PVC	50
42202	0,9 mm	30 m	PVC	50



SZÖGESDRÓT Zn

Zn

R.s.	Ø huzal	vezeték hossza	
42260	1,7 mm	50 m	1
42261	1,7 mm	100 m	1



KÉZI CSÖRLŐ

R.s.	leírás	
50035	2 t	6
50036	4 t	4



DRÓTFESZÍTŐ

Zn

R.s.	leírás	
50030	vékony Zn bevonat	50
50032	vékony műanyag bevonat PVC	50



KÖTŐZÓDRÓT Zn

Zn

R.s.	Ø huzal	vezeték hossza	
42207	0,8 mm	50 m	40
42208	0,8 mm	100 m	20
42209	0,9 mm	100 m	20
42240	1,0 mm	50 m	40
42210	1,0 mm	100 m	20
42211	1,2 mm	50 m	40
42212	1,2 mm	100 m	20
42213	1,4 mm	30 m	40
42214	1,4 mm	50 m	20
42217	1,8 mm	30 m	40
42218	1,8 mm	50 m	20



KÖTŐZŐ PVC

R.s.	Ø huzal	vezeték hossza	
42244	1,4 mm	50 m	20
42248	1,8 mm	50 m	20
42249	2,0 mm	50 m	20



DRÓTFESZÍTŐ, ROZSDAMENTES VÉG

R.s.	leírás	MOQ	
50040	zöld	50	50
50041	fekete	50	50



DRÓTFESZÍTŐ

Zn

R.s.	leírás	
50031	masszív Zn bevonat	50
50033	masszív műanyag bevonat PVC	50



KÖTŐZÓDRÓT Zn

Zn

R.s.	Ø huzal	vezeték hossza	
42219	2,0 mm	26 m	20
42220	2,0 mm	52 m	20
42221	2,0 mm	78 m	20
42228	3,15 mm	26 m	10
42229	3,15 mm	52 m	10
42230	3,15 mm	78 m	10



KÖTŐZŐ PVC

R.s.	Ø huzal	vezeték hossza	
42251	2,6 mm	26 m	20
42252	2,6 mm	52 m	20
42253	2,6 mm	78 m	20
42255	3,4 mm	26 m	10
42256	3,4 mm	52 m	10
42257	3,4 mm	78 m	10



DRÓTFESZÍTŐ

R.s.	leírás	MOQ	
50042		10	10



DRÓTFESZÍTŐ

Zn

R.s.	leírás	
50037	vékony Zn bevonat	50
50038	vékony műanyag bevonat PVC	50

OSZLOPTARTÓ

Zn

R.s.	leírás	tl.		
55436	70 x 75 mm	110 mm	4 mm	10
55437	80 x 90 mm	130 mm	4 mm	10



OSZLOPTARTÓ

Zn

R.s.	leírás	tl.		
55429	70 x 60 mm	100 mm	4 mm	10
55433	81 x 60 mm	100 mm	4 mm	10
55430	91 x 60 mm	100 mm	4 mm	10
55431	101 x 60 mm	100 mm	4 mm	10
55432	121 x 60 mm	100 mm	4 mm	10

OSZLOPTARTÓ,
ÁLLÍTHATÓ

Zn

R.s.	Leírás	tl.		
55465	80 - 160 x 70 mm	100 mm	4 mm	1

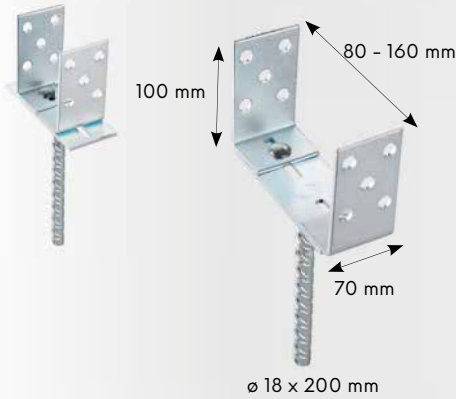

OSZLOPTALP ZN

Zn

R.s.	Ø kotwica	długość kotwicy	grubość materiału	
55420	71 x 71 mm	150 mm	2 mm	1
55425	81 x 81 mm	150 mm	2 mm	1
55421	91 x 91 mm	150 mm	2 mm	1
55422	101 x 101 mm	150 mm	2 mm	1
55423	121 x 121 mm	150 mm	2 mm	1
55424	151 x 151 mm	150 mm	2 mm	1



FÖLDFÚRÓ

R.s.	Ø	A	B	
61299	110 mm	270 mm	1200 mm	1
61300	140 mm	270 mm	1200 mm	1
61301	170 mm	270 mm	1200 mm	1
61302	200 mm	270 mm	1200 mm	1

ÁLLÍTHATÓ OSZLOP TARTÓ TALP

Zn

R.s.	Ø kotwica	wysokość kotwicy	wątek	
55460	80 x 80 mm	150 mm	M16	10
55461	100 x 100 mm	150 mm	M16	10
55462	150 x 150 mm	150 mm	M24	10



OSZLOPTALP

Zn

R.s.	Ø kotwica	długość kotwicy	grubość materiału	
55400	71 x 71 mm	750 mm	2 mm	1
55401	91 x 91 mm	750 mm	2 mm	1
55406	81 x 81 mm	750 mm	2 mm	1
55402	91 x 91 mm	900 mm	2 mm	1
55403	101 x 101 mm	900 mm	2 mm	1
55404	121 x 121 mm	900 mm	2 mm	1
55405	151 x 151 mm	900 mm	2 mm	1

OSZLOPLEHOR-
GANYZÓ
CSAVAROS
TÜSKE "U"

Zn

R.s.	Ø kotwica	długość kotwicy	grubość materiału	
55455	71 x 60 mm	100 mm	4 mm	1
55452	81 x 60 mm	100 mm	4 mm	1
55456	90 x 60 mm	100 mm	4 mm	1
55453	101 x 60 mm	100 mm	4 mm	1
55457	110 x 60 mm	100 mm	4 mm	1
55454	121 x 60 mm	100 mm	4 mm	1

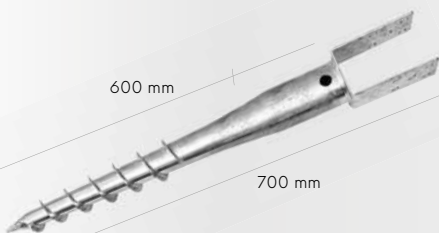
UNIVERZÁLIS
NAPERNYŐ TARTÓ

csökkentés

Ø 24 mm
Ø 35 mm
Ø 40 mm
Ø 48 mm
Ø 55 mm

Zn 6x

R.s.	Ø kotwica	długość kotwicy	leírás	
55450	60 mm	550 mm	1 db + 5x csökkentés	8



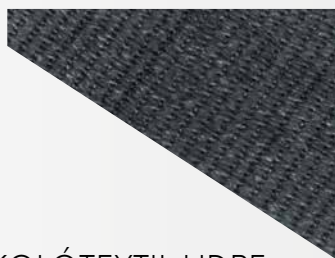

ÁRNYÉKOLÓTEXTIL HDPE 150 G/ M² ANTRACIT

· árnyékolás 85%

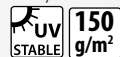

R.s.	leírás	
45496	1 x 10 m	1
45497	1,5 x 10 m	1
45498	1,8 x 10 m	1
45499	2 x 10 m	1

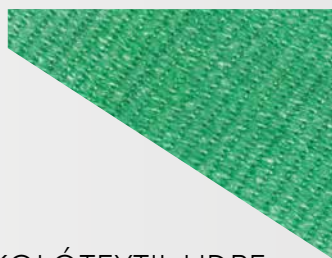

ÁRNYÉKOLÓTEXTIL HDPE 150 G/ M²

· árnyékolás 85%

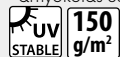

R.s.	leírás	
45460	1 x 10 m	1
45461	1,5 x 10 m	1
45463	1,8 x 10 m	1
45462	2 x 10 m	1



ÁRNYÉKOLÓTEXTIL HDPE 220 G/ M²

· árnyékolás 95%



R.s.	leírás	
45465	1 x 10 m	1
45466	1,5 x 10 m	1
45467	2 x 10 m	1

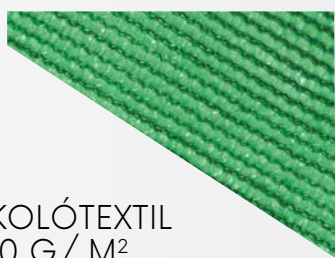

ÁRNYÉKOLÓTEXTIL HDPE 80 G/ M²



R.s.	leírás	
45450	1 x 10 m	1
45451	1,5 x 10 m	1
45453	1,8 x 10 m	1
45452	2 x 10 m	1

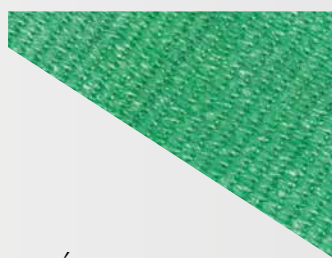

ÁRNYÉKOLÓTEXTIL HDPE 150 G/ M²

· árnyékolás 85%

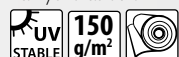

R.s.	leírás	
45480	1,5 x 50 m	1



ÁRNYÉKOLÓTEXTIL HDPE 220 G/ M²

· árnyékolás 95%



R.s.	leírás	
45485	1,5 x 50 m	1



KÁBELKÖTÖZŐ

· EN 50146
· nylon



R.s.	leírás	
23875	120 mm 4,8 mm	1



R.s.	leírás	
45470		1

ÁRNYÉKOLÓ RÖGZÍTŐ





GRILLEZŐ KLT.

INOX 18x

R.s. leírás
43077

6



GRILLEZŐ KLT.

INOX 3x

R.s. leírás
43071 380 mm

16



GRILLEZŐ FOGÓ

INOX

R.s. leírás
43072 360 mm

25



ALU GRILL TÁLCA

4x

R.s. leírás
43050 300 x 200 mm

50

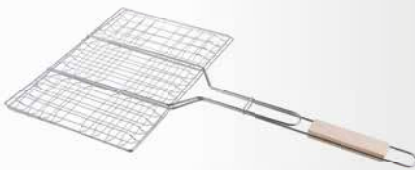

HÚS GRILLEZŐ

R.s. leírás
43084 330 x 290 mm

50

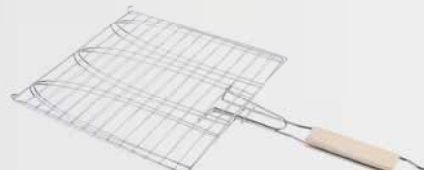

HAL GRILLEZŐ

R.s. leírás
43082 280 x 276 mm

50

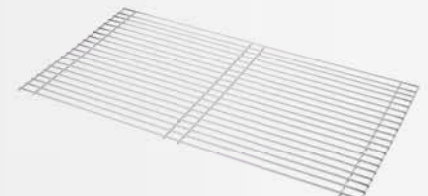

GRILL RÁCS

R.s. leírás
43058 58 x 30 mm 20
43060 60 x 40 mm 20
43068 68 x 40 mm 16

HAL GRILLEZŐ

R.s. leírás
43083 360 x 130 mm

12



SASLIK GRILL NYÁRS

4x

R.s. leírás
43086 Ø 3 x 380 mm

80



VILLA

• higiéniai jóváaggyással

R.s. leírás
43097 100 cm

100



GRILLVILLA - TELESZKÓPOS

INOX



R.s. Specifikáció
43094

1



LÉGFUVÓ, MECH.



R.s. leírás
43087

1



GRILLKAPARÓ

R.s. leírás
43098 30 cm

10



GRILL TISZTÍTÓ KEFE

R.s. leírás
43099

40



GRILL FORGATÓ MOTOR ELKTR. 230V

CE



R.s. leírás
43090

24



GRILL FORGATÓ MOTOR ELEMES



R.s. leírás
43089

48



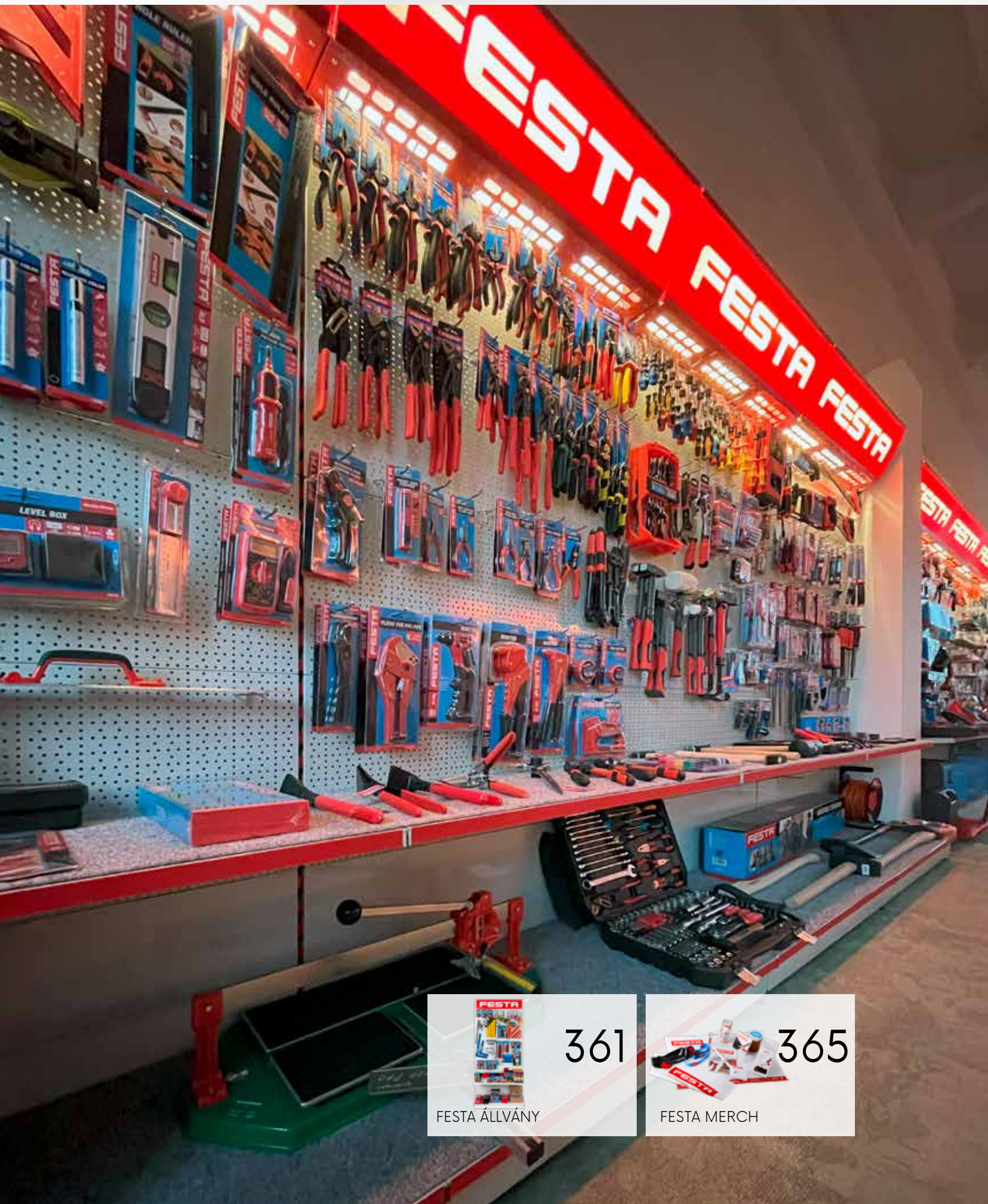

361

FESTA ÁLLVÁNY



365

FESTA MERCH



 FESTA ÁLLVÁNY FELSZERELT

FESTA
VILÁGÍTÓDOBOZ FESTA ÁLLVÁNYHOZ 81011

R.s.	leírás	
81195	FESTA POWER TOOLS	1
81196	FESTA	1
81197	FESTA INDUSTRY	1



BEMUTATÓ ÁLLVÁNY FESTA



R.s.	leírás	
81011	állvány FESTA CZ 200 x 100 cm	1
81011A	állvány 81011 + matrica AQUATIC	1
81011F	állvány 81011 + matrica FESTA CZ	1
81011G	állvány 81011 + matrica FESTA GB	1
81011H	állvány 81011 + matrica FESTA SK	1
81011R	állvány 81011 + matrica ROSA	1
81012	polc fehér CZ mélység 40	8
81013	horog 10 cm	10
81014	horog 16 cm	10
81015	horog 20 cm	10
81035	horog 20 cm	10
81016	horog 30 cm	10
81036	horog 30 cm	10
81022	drótkosár - nagy	1
81023	drótkosár - kicsi	1
81024	partíció - nagy	1
81025	partíció - kicsi	1

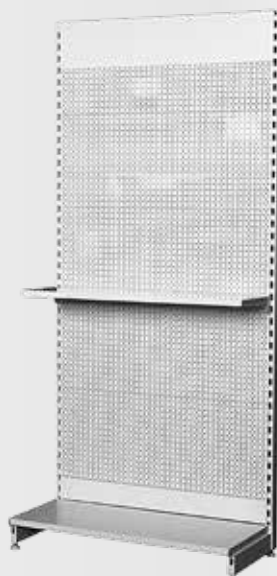

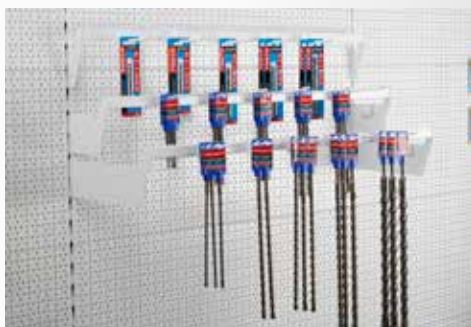

TARTÓ KONZOL

· FESTA állványhoz kompatibilis

R.sz.	leírás	
81150	1000 × 50 × 135 mm	1
81151	1000 × 150 × 135 mm	1
81152	1000 × 350 × 135 mm	1

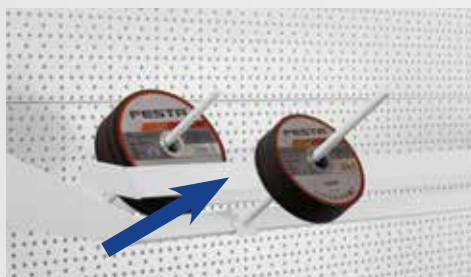

ÁR CÍMKE TARTÓ

· FESTA állványhoz kompatibilis

R.sz.	leírás	
81155	1000 × 80 × 100 mm	1



KAMPÓ VÁGÓKORONGOKHOZ

· FESTA állványhoz kompatibilis

R.sz.	leírás	
81186	150 mm	1
81185	250 mm	1



VÁGÓKORONG TARTÓ KONZOL

· FESTA állványhoz kompatibilis

R.sz.	leírás	
81170	1000 × 450 × 85 mm	1



FŰRÉSZ TARTÓ

· FESTA állványhoz kompatibilis

R.sz.	leírás	
81190		1



KAMPÓ AZ AKKUMULÁTOROS SZERSZÁMOKHOZ

· FESTA állványhoz kompatibilis

R.sz.	leírás	
81189		1



GYÉMÁNTVÁGÓ KORONG TARTÓ

· FESTA állványhoz kompatibilis

R.sz.	leírás	
81191	220 × 220 × 200 mm	1

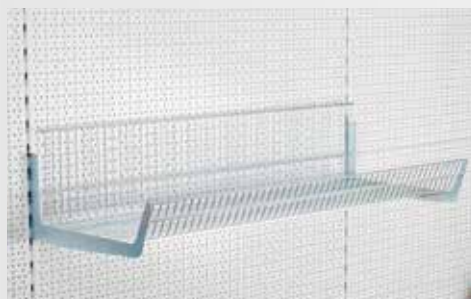

TARTÓ KOSÁR

· FESTA állványhoz kompatibilis

R.sz.	leírás	
81160	1000 × 470 × 180 mm	1



ELVÁLASZTÓ

· FESTA állványhoz kompatibilis

R.sz.	leírás	
81165	470 × 180 mm	1



KALAPÁCSOK TARTÓ

Zn

· FESTA állványhoz kompatibilis

R.sz.	leírás	
81188	max 2 kg	1

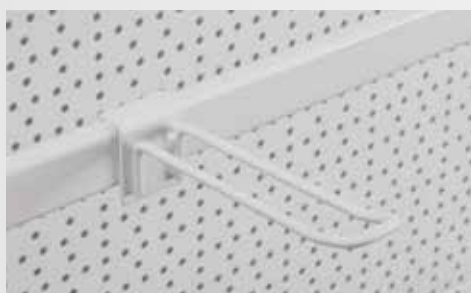

KAMPÓ KERESZTTARTÓRA

· FESTA állványhoz kompatibilis

R.sz.	leírás	
81175	120 mm	1
81178	180 mm	1



KAMPÓ KERESZTTARTÓRA

· FESTA állványhoz kompatibilis

R.sz.	leírás	
81180	120 mm	1



R.sz.	leírás	
81200	Handstand 40/2400 mm anchored	1
81201	Handstand 80/1108 mm	1
81202	Handstand 80/1208 mm	1
81203	Handstand 80/1408 mm	1
81204	Handstand 80/1608 mm	1
81205	Handstand 80/1808 mm	1
81206	Handstand 80/2000 mm	1
81207	Handstand 80/2108 mm	1
81208	Handstand 80/2208 mm	1
81209	Handstand 80/2308 mm	1
81210	Handstand 80/2408 mm	1
81211	Handstand 80/2600 mm	1
81212	Handstand 60/1000 mm	1
81213	Handstand 60/1208 mm	1
81214	Handstand 60/1408 mm	1
81215	Handstand 60/1608 mm	1
81216	Handstand 60/1808 mm	1
81217	Handstand 60/2108 mm	1
81218	Handstand 60/2208 mm	1
81225	Handstand 30/2108 mm front	1
81486	Handstand 60/2000 mm	1
81219	Adapter of handstand 80x30/100mm	1
81220	Adapter of handstand 80x30/400 mm	1
81221	Adapter of handstand 80x30/600 mm	1
81222	Adapter of handstand 60x30/400 mm	1
81223	Corner handstand 90° 2100mm	1
81224	Corner handstand 90° 2200mm	1
81226	Support 80	1
81227	Support 60	1
81228	Clutch gondolas with a shelf 80	1
81229	Anchor bar	1
81230	Anchor hook	1
81231	Anchoring light	1
81232	Anchoring top	1
81233	Filling 400	1
81234	Filling 500	1
81235	Filling 600	1
81236	Filling 700	1
81237	Filling 800	1
81238	Console low 200	1
81239	Console low 300	1
81240	Console low 400	1
81241	Console low 500	1
81242	Console high 400	1
81243	Console high 500	1
81244	Console high 600	1
81245	Console high 700	1
81246	Console low 300 double	1
81247	Console low 400 double	1
81248	Console low 300 double	1
81251	Console RR 80	1
81249	Console high double 500	1
81250	Beam showcase 400/2000	1
81252	Hyphen trough shelves	1
81253	Hyphen low 300	1
81254	Hyphen low 400	1
81255	Hyphen low 500	1
81256	Hyphen low 300 glass	1
81257	Hyphen low 400 glass	1
81258	Hyphen low 500 glass	1
81259	Hyphen high 300 glass	1
81262	Hyphen high 300 plexi	1
81263	Hyphen high 400 plexi	1
81264	Hyphen high 500 plexi	1
81260	Hyphen high 400 glass	1
81261	Hyphen high 500 glass	1
81265	Side of showcase 400/2000	1
81266	Sidewall roofing RR 80	1
81267	Sidewall tray 500mm	1
81268	Sidewall showcase 500	1
81269	Beam showcase 500	1
81271	Sidewall shelves low 300 plastic	1
81272	Sidewall shelves low 400 plastic	1
81273	Sidewall shelves low 500 plastic	1
81274	Sidewall high glass 300/250	1
81275	Safety fuse	1
81276	Sidewall high glass 500/250	1
81277	Sidewall shelves high 400	1
81278	Sidewall shelves high 500	1
81270	Beam roofing RR 80	1
81279	Beam roofing	1
81280	Sidewall roofing left	1
81281	Sidewall roofing right	1
81282	Suspension arm	1
81284	Double shoulder 400/10	1
81285	Double shoulder 300/8	1
81286	Simple shoulder 350	1
81287	Simple shoulder 500	1
81288	Simple shoulder 250	1
81289	Double hinge 100	1
81290	Double hinge 200	1
81291	Double hinge 300	1
81292	Hinge 130 V	1

R.sz.	leírás	
81293	Simple hinge 100	1
81294	Simple hinge 200	1
81295	Simple hinge 300	1
81296	Hook with horizontal bar 200	1
81297	Hook with horizontal bar 300	1
81298	Lock showcase	1
81299	Hyphen wire 360mm high	1
81300	Hyphen wire 460 mm high	1
81301	Hyphen wire 560 mm high	1
81302	Hyphen wire 560 mm nízke	1
81303	Bracket 300 double L	1
81304	Bracket 300 double P	1
81305	Bracket 400 double L	1
81306	Bracket 400 double P	1
81307	Bracket 500 double L	1
81308	Bracket 500 double P	1
81309	Shelf semicircle 300	1
81310	Shelf semicircle 400	1
81311	Shelf semicircle 500	1
81312	Sokl pülkrúhu 500	1
81313	Forehead base semicircle 500	1
81314	Bracket 300 price tag semicircle	1
81315	Bracket 400 price tag semicircle	1
81316	Bracket 500 price tag semicircle	1
81317	Shelf semicircle 600	1
81318	Plinth semicircle 600	1
81319	Forehead base semicircle 600	1
81320	Price tag P 7,5x5 cm	1
81321	Price tag P 2,6x3,2 cm	1
81322	Price tag P 5,0x4,0 cm	1
81323	Perforated shelf 500/1000	1
81324	Connector upright 80, Module 1	1
81325	Rear panel 10x100cm	1
81326	Rear panel 20x100cm	1
81327	Rear panel 40x100cm	1
81328	Perforated rear panel 20x100 cm EUR	1
81329	Perforated rear panel 40x100 cm EUR	1
81330	Cover gondolas 8x100cm	1
81331	Cover gondolas 6x100cm	1
81332	Beam hinges 100cm	1
81333	Glass shelf 985/300 vitrine	1
81334	Glass shelf 985/400 vitrine	1
81335	Wooden shelf 47/98,5	1
81336	Wire shelf 1000/500	1
81337	Troughed shelf 1000x500	1
81338	Shelf 200/1000	1
81339	Shelf 300/1000	1
81340	Shelf 400/1000	1
81341	Shelf 500/1000	1
81342	Shelf 400/1000 RAL7015	1
81343	Shelf 500/1000 RAL7015	1
81347	High frame showcases 1000/400	1
81348	Glass frame high showcases 1000/400	1
81349	Female insert shelf	1
81350	Suspended ceiling metal shelves 500/100	1
81352	Front support high glass 1000 mm	1
81353	Front support high plexi	1
81354	Front support low plastic 1000 mm	1
81355	Price bar, 1000mm	1
81356	Comb socket rack	1
81351	Comb for high dividers, 1000	1
81357	Comb, 1000 mm	1
81403	Comb for high dividers, 1250 mm	1
81420	Comb for high dividers, 625 mm	1
81358	Double-groove door showcases	1
81359	Price tag holder, 1000mm	1
81360	Door showcases 1000/2000	1
81361	Forehead roofing, 1000mm	1
81362	Tile roofing, 1000mm	1
81363	Tray door	1
81364	Sliding door showcases	1
81365	Mirror showcases	1
81366	Hinge frame, module 1	1
81367	Curtain rod	1
81370	Trash wire oblique	1
81371	Tour 1000mm full plate	1
81372	Skirting the counter SU 5 1000mm	1
81373	Counter glassed 1000mm	1
81374	Counter with stainless steel plate 1000mm	1
81375	Counter with full plate 600mm	1
81376	Shelf counter 600mm	1
81377	Counter glassed 600mm	1
81378	Shelf counter 1000mm	1
81379	Long shelf counter	1
81380	Segment counter high 90°	1
81381	Double-groove counter 1000mm, couple	1
81382	Sliding doors counter 1000mm, couple	1
81383	Drawer board	1
81384	Wire shelf RDE 1000/360mm	1
81385	Wire shelf RDE 1000/460mm	1
81386	Wire shelf RDE 1000/560mm	1
81387	Price bar RDE 1000 mm	1
81388	Rear panel 100/1250mm full	1

R.sz.	leírás	
81389	Rear panel 200/1250mm full	1
81390	Rear panel 400/1250mm full	1
81391	Rear panel 200/1250mm perforated	1
81393	Cover gondolas 80/1250mm	1
81392	Rear panel 400/1250mm perforated	1
81394	Cover gondolas 60/1250mm	1
81395	Beam hinges 1250mm	1
81396	Shelf 200/1250mm	1
81439	Beam hinges 1000 mm	1
81344	Shelf 300/1000 releírásrce	1
81345	Shelf 400/1000 releírásrce	1
81346	Shelf 500/1000 releírásrce	1
81397	Shelf 300/1250mm	1
81400	Shelf 300/1250mm, releírásrce	1
81401	Shelf 400/1250mm, releírásrce	1
81402	Shelf 500/1250mm, releírásrce	1
81398	Shelf 400/1250mm	1
81399	Shelf 500/1250mm	1
81404	Front fulcrum low 1250mm, white plastic	1
81405	Price bar, 1250mm	1
81406	Comb 1250mm	1
81407	Price tag holder, 1250mm	1
81408	Forehead roofing, 1250mm	1
81409	Tile roofing, 600x1250mm	1
81410	Rear panel 100/625 full	1
81411	Rear panel 200/625 full	1
81412	Rear panel 400/625 full	1
81413	Rear panel 400/625 perforated	1
81414	Cover gondolas 80/650	1
81415	Cover gondolas 60/650	1
81416	Beam hinges, module 3	1
81432	Beam hinges, 1330mm	1
81417	Shelf 300/625	1
81418	Shelf 400/625	1
81419	Shelf 500/625	1
81421	Front support low 625, white plastic	1
81422	Price bar 625mm	1
81423	Comb 625mm	1
81424	Price tag holder, 625mm	1
81425	Rear panel 100/1330 full	1
81457	Molded plastic abutment low 200	1
81426	Rear panel 200/1330 full	1
81427	Rear panel 400/1330 full	1
81428	Rear panel 200/1330 perforated S	1
81429	Rear panel 400/1330 perforated S	1
81430	Cover gondolas 80/1330	1
81431	Cover gondolas 60/1330	1
81433	Shelf 300/1330	1
81434	Shelf 400/1330	1
81435	Shelf 500/1330	1
81436	Price bar, 1330 mm	1
81437	Comb 1330 mm	1
81438	Price tag holder 1330 mm	1
81440	Wire shelf - basket	1
81441	Rear panel 100 fillet	1
81442	Rear panel 400 fillet	1
81443	Forehead plinth fillet 500/1000mm	1
81444	Forehead plinth fillet 600 mm	1
81445	Rear panel fillet 400mm perforated	1
81447	Shelf 300 fillet	1
81448	Shelf 400 fillet	1
81449	Shelf 500 fillet	1
81450	Shelf 600 fillet	1
81451	Price tag holder 300 fillet	1
81452	Price tag holder 400 fillet	1
81453	Price tag holder 500 fillet	1
81454	Price bar 300 fillet	1
81455	Price bar 400 fillet	1
81456	Price bar 500 fillet	1
81458	Wire shelf basket U 1000/400	1
81459	Wire shelf basket U 1000/500	1
81460	Corner forehead plinth 90°	1
81461	Rear corner panel 100, stand 60	1
81462	Rear corner panel 200, stand 60	1
81463	Rear corner panel 400, stand 80	1
81466	Rear corner panel 100, stand 80	1
81467	Rear corner panel 400, stand 60	1
81468	Police corner 90° 400mm	1
81469	Police corner 90° 500mm	1
81470	Price tag holder corner 90° 400mm	1
81471	Price tag holder corner 90° 500mm	1
81472	Price bar fillet 90° 400mm	1
81473	Price bar fillet 90° 500mm	1



KONZOL FEHÉR

MOQ
2

R.sz.	leírás	
81100	100 x 75 mm	24
81101	125 x 100 mm	24
81102	150 x 125 mm	24
81103	200 x 150 mm	24
81104	250 x 200 mm	24
81105	300 x 250 mm	24
81106	350 x 300 mm	24



POLCTARTÓ, EGYSZERŰ

R.sz.	leírás	
81053	50 cm	10
81054	80 cm	10
81057	200 cm	10



REGÁL KAMPÓ

R.sz.	leírás	
81070	10 cm	10
81071	15 cm	10
81077	50 cm	10



PAPÍR KÍNÁLÓ ÁLLVÁNY SZINTEZŐ RENDSZER



R.sz.	leírás	
37179	60 x 40 x 175 cm - ENG	1



PAPÍR KÍNÁLÓ ÁLLVÁNY FESTA SZERSZÁMOK



R.sz.	leírás	
81602	60 x 40 x 175 cm - ENG	1

PAPÍR KÍNÁLÓ ÁLLVÁNY FESTA KISGÉPEK



R.sz.	leírás	
81603	60 x 40 x 175 cm	1



FESTA
FEST REKLÁMBLOKK

R.s. leírás
M90400



1

FESTA
FESTA PIROS REKLÁMPÓLÓ

R.s.	leírás	
M90203	M	1
M90204	L	1
M90205	XL	1
M90206	XXL	1
M90207	XXXL	1



FESTA
FESTA REKLÁMTOLL

R.s. leírás
M90403



1



FESTA
FESTA REKLÁMZOKNI

R.s.	leírás	
M90220	39-41	1
M90221	42-44	1
M90222	45-47	1



FESTA
FESTA REKLÁM USB KÁBEL

R.s. leírás
M90519



1



FESTA
FESTA REKLÁMSAPKA

R.s.	leírás	
M90210		1



FESTA
REKLÁMMÉRŐ FESTA

R.s. leírás
11410 2 m x 16 mm

MOQ
12



1



FESTA
FESTA REKLÁM ÖSSZECSUKHATÓ KÉS

R.s.	leírás	
16209		1



1

Cikkszám	oldal	Cikkszám	oldal	Cikkszám	oldal	Cikkszám	oldal	Cikkszám	oldal	Cikkszám	oldal
10002	96	11355	98	13249	121	13414	101	13509	99	14420	104
10003	96	11356	98	13250	121	13415	101	13510	99	14421	104
10005	96	11358	98	13251	121	13416	101	13511	99	14425	105
10008	96	11360	98	13252	121	13417	101	13512	99	14430	105
10025	96	11410	100	13253	121	13418	101	13513	99	14435	105
10033	96	11410	365	13254	121	13419	101	13514	99	14440	105
10035	96	11416	99	13255	121	13420	101	13515	99	14445	105
10043	96	11420	100	13256	121	13421	101	13516	99	14446	105
10045	96	11425	100	13257	121	13422	101	13517	99	14450	105
10048	96	11444	100	13258	121	13423	101	13518	99	14451	105
10110	96	11445	100	13259	121	13424	101	13519	99	14455	105
10120	96	12010	99	13260	120	13425	101	13520	99	14456	105
10130	96	12020	99	13261	117	13426	101	13521	99	14457	105
10330	96	12030	99	13262	117	13427	101	13522	99	14458	105
10332	96	12050	99	13263	117	13428	101	13523	99	14471	105
10334	96	12110	99	13264	116	13429	101	13524	99	14472	105
10336	96	12120	99	13265	116	13430	101	13525	99	14473	105
10430	97	12130	99	13266	116	13431	101	13526	99	14474	105
10450	97	12150	99	13267	117	13432	101	13527	99	14480	104
10490	97	12220	99	13268	116	13433	101	13528	99	14485	109
10996	97	12230	99	13269	116	13434	101	13529	99	14485	271
10998	97	12250	99	13270	116	13435	101	13530	99	14486	109
10999	97	12433	100	13271	116	13436	101	13531	99	14486	271
11002	99	12435	100	13272	116	13437	101	13532	99	14490	105
11003	99	13010	101	13273	116	13438	101	13533	99	14491	105
11005	99	13020	101	13274	116	13439	101	13534	99	14492	105
11006	99	13021	101	13275	116	13440	101	14001	102	14493	105
11007	99	13022	101	13276	117	13441	101	14002	102	14494	105
11008	99	13023	101	13277	120	13442	101	14003	102	15003	107
11082	99	13111	101	13278	116	13443	101	14004	102	15004	107
11083	99	13120	101	13279	117	13444	101	14006	102	15005	107
11085	99	13200	118	13280	117	13445	101	14007	102	15006	107
11102	98	13201	118	13281	102	13446	101	14008	102	15008	107
11103	98	13202	118	13282	102	13447	101	14009	102	15010	107
11105	98	13205	119	13284	117	13448	101	14010	103	15012	107
11106	98	13206	119	13285	102	13449	101	14011	103	15015	107
11107	98	13207	119	13288	117	13450	101	14012	103	15018	107
11110	98	13208	119	13290	217	13451	101	14013	102	15020	107
11200	99	13211	101	13293	217	13452	101	14015	103	15033	106
11201	99	13212	119	13294	217	13453	101	14017	103	15034	106
11202	99	13214	118	13295	120	13454	101	14019	103	15035	106
11204	99	13216	118	13296	120	13455	101	14025	105	15036	106
11205	99	13217	118	13350	121	13456	101	14030	103	15037	106
11206	99	13218	118	13351	121	13457	101	14035	102	15039	106
11207	99	13219	118	13352	121	13458	101	14040	102	15103	107
11208	99	13220	101	13353	121	13459	101	14045	102	15104	107
11209	99	13222	118	13354	121	13460	101	14060	103	15105	107
11210	99	13223	118	13355	121	13461	101	14070	103	15106	107
11220	98	13224	118	13360	121	13462	101	14075	103	15108	107
11221	98	13225	118	13361	121	13463	101	14077	103	15110	107
11226	98	13226	118	13362	121	13464	101	14080	102	15112	107
11239	98	13227	118	13363	121	13465	101	14090	104	15115	107
11259	98	13228	118	13364	121	13466	101	14091	104	15118	107
11260	98	13229	118	13365	121	13467	101	14220	105	15120	107
11311	100	13230	118	13399	101	13468	101	14225	105	15204	107
11312	100	13231	118	13400	101	13469	101	14230	105	15205	107
11313	100	13235	118	13401	101	13470	101	14235	105	15206	107
11314	100	13236	118	13402	101	13471	101	14240	105	15208	107
11323	98	13237	118	13403	101	13472	101	14250	105	15210	107
11325	98	13238	118	13404	101	13473	101	14350	105	15212	107
11327	98	13240	120	13405	101	13500	99	14360	105	15215	107
11333	98	13241	120	13406	101	13501	99	14370	105	15218	107
11335	98	13242	120	13407	101	13502	99	14380	105	15220	107
11337	98	13243	120	13408	101	13503	99	14399	105	15230	107
11338	98	13244	120	13409	101	13504	99	14410	105	15235	108
11343	98	13245	120	13410	101	13505	99	14411	105	15301	109
11345	98	13246	119	13411	101	13506	99	14415	104	15301	271
11347	98	13247	119	13412	101	13507	99	14417	104	15310	108
11353	98	13248	119	13413	101	13508	99	14418	104	15310	270

Cikkszám	oldal	Cikkszám	oldal	Cikkszám	oldal	Cikkszám	oldal	Cikkszám	oldal	Cikkszám	oldal
15315	108	15810	109	16003	122	16075	130	16300	139	17037	137
15315	270	15810	271	16004	122	16077	130	16301	139	17038	177
15318	108	15812	109	16005	122	16078	130	16303	139	17039	176
15318	270	15812	271	16006	122	16081	130	16304	139	17040	174
15320	108	15815	109	16010	122	16082	129	16305	138	17041	174
15320	270	15815	271	16010	122	16083	131	16306	138	17042	174
15325	108	15818	109	16011	122	16084	131	16307	138	17043	174
15325	270	15818	271	16011	122	16085	126	16308	138	17044	174
15330	108	15820	109	16011	122	16086	126	16309	138	17045	174
15330	270	15820	271	16012	122	16087	127	16310	139	17046	177
15335	108	15825	109	16012	122	16090	125	16310	139	17047	172
15335	270	15825	271	16012	122	16091	125	16311	139	17048	177
15340	108	15830	109	16013	122	16095	127	16311	139	17049	177
15340	270	15830	271	16013	122	16099	124	16311	139	17050	139
15415	108	15850	109	16016	122	16100	124	16312	139	17050	181
15415	270	15850	271	16017	122	16105	124	16312	139	17051	177
15418	108	15853	109	16019	122	16110	124	16315	137	17052	177
15418	270	15853	271	16021	128	16115	124	16315	137	17053	177
15420	108	15855	109	16023	127	16120	124	16319	139	17054	177
15420	270	15855	271	16024	128	16125	124	16320	139	17055	177
15425	108	15860	109	16025	125	16130	126	16321	139	17056	177
15425	270	15860	271	16026	128	16131	124	16321	229	17057	177
15430	108	15870	109	16028	128	16135	126	16401	181	17058	177
15430	270	15870	271	16029	125	16136	125	16405	181	17059	176
15510	108	15880	109	16030	128	16137	125	16406	181	17060	176
15510	270	15880	271	16031	128	16140	126	16407	181	17061	176
15515	108	15885	256	16032	128	16141	128	16408	181	17062	176
15515	270	15886	256	16033	127	16142	125	16420	181	17063	175
15518	108	15886	349	16034	126	16143	125	16500	176	17064	175
15518	270	15887	256	16035	127	16144	125	16501	176	17065	175
15520	108	15887	349	16036	129	16145	125	16502	176	17066	175
15520	270	15888	256	16037	127	16146	125	16990	136	17067	175
15525	108	15888	349	16039	127	16147	126	16990	320	17068	175
15525	270	15889	256	16041	129	16150	125	16991	136	17069	175
15530	108	15893	109	16042	129	16151	125	16991	320	17070	175
15530	270	15893	271	16042	279	16198	131	16998	122	17071	175
15535	108	15894	109	16043	128	16199	131	16999	122	17072	175
15535	270	15894	271	16044	126	16201	132	17001	171	17075	175
15540	108	15895	109	16046	128	16202	173	17002	171	17076	175
15540	270	15895	271	16049	129	16205	173	17003	171	17077	175
15615	108	15904	111	16050	129	16206	173	17004	171	17078	177
15615	270	15906	111	16051	129	16208	173	17005	171	17079	176
15620	108	15908	111	16052	129	16209	133	17006	171	17080	176
15620	270	15910	111	16053	128	16209	365	17007	171	17081	176
15625	108	15912	111	16054	129	16210	132	17008	171	17082	176
15625	270	15915	111	16055	128	16211	132	17009	171	17083	178
15630	108	15920	111	16056	278	16212	132	17010	171	17084	176
15630	270	15954	111	16057	126	16218	133	17011	171	17085	176
15710	109	15956	111	16058	126	16219	133	17012	176	17086	176
15710	270	15958	111	16059	129	16220	133	17013	176	17087	172
15715	109	15960	111	16060	130	16221	133	17014	176	17089	178
15715	270	15962	111	16061	130	16222	133	17015	178	17090	178
15720	109	15965	111	16062	130	16223	133	17016	178	17091	178
15720	270	15970	111	16063	130	16224	134	17017	178	17092	178
15725	109	15980	111	16064	130	16225	132	17019	178	17093	178
15725	270	15981	111	16065	130	16226	134	17020	177	17094	171
15730	109	15983	100	16066	124	16227	134	17021	177	17095	171
15730	270	15985	100	16066	130	16228	134	17022	177	17096	171
15735	109	15988	100	16067	130	16229	132	17023	175	17097	171
15735	270	15989	100	16068	130	16230	132	17024	171	17098	171
15740	109	15990	111	16069	129	16231	132	17025	174	17099	171
15740	270	15991	111	16070	129	16231	135	17026	137	17100	171
15754	110	15992	111	16070	131	16232	134	17027	137	17101	169
15756	110	15993	111	16071	127	16232	174	17028	177	17102	169
15758	110	15996	110	16071	130	16234	132	17029	176	17103	169
15760	110	15997	110	16072	130	16235	133	17033	176	17104	169
15762	110	15998	110	16073	131	16236	133	17034	175	17105	169
15768	110	15999	110	16074	126	16281	127	17035	175	17108	171
15770	110	16002	122	16074	131	16282	127	17036	175	17109	175

Cikkszám oldal	Cikkszám oldal	Cikkszám oldal	Cikkszám oldal	Cikkszám oldal	Cikkszám oldal
17110 171	17238 156	17393 160	17528 165	17622 164	17831 159
17111 179	17240 158	17394 160	17532 166	17623 164	17832 159
17112 179	17241 158	17395 160	17533 166	17624 164	17835 159
17113 179	17242 158	17396 160	17534 166	17625 164	17836 159
17116 179	17243 158	17397 160	17539 165	17626 164	17837 159
17117 179	17244 158	17398 160	17548 164	17628 164	17838 159
17121 179	17245 155	17400 161	17549 164	17629 164	17839 159
17122 179	17247 153	17401 160	17550 164	17630 164	17840 159
17125 172	17250 161	17402 160	17551 164	17631 164	17841 159
17126 172	17255 161	17405 160	17552 164	17632 164	17842 159
17127 172	17259 153	17406 160	17553 164	17633 164	17843 159
17128 172	17260 153	17407 160	17554 164	17640 166	17844 159
17130 172	17261 167	17410 160	17555 164	17642 166	17845 159
17133 172	17262 167	17411 160	17556 164	17643 166	17846 159
17135 172	17292 158	17412 160	17557 164	17644 166	17847 159
17137 172	17294 158	17413 160	17558 164	17645 166	17848 159
17138 172	17295 158	17414 160	17559 164	17650 166	17849 159
17140 169	17296 158	17415 160	17560 164	17651 166	17850 159
17142 169	17297 158	17416 160	17561 164	17652 166	17851 159
17145 169	17298 158	17420 160	17562 164	17653 166	17852 159
17146 169	17299 158	17421 160	17563 164	17654 166	17853 159
17148 169	17300 178	17422 160	17564 164	17655 166	17854 159
17150 175	17301 178	17427 161	17565 164	17656 166	17855 159
17151 175	17302 178	17450 167	17566 164	17657 166	17856 159
17158 181	17303 178	17451 167	17567 164	17658 166	17860 159
17159 181	17304 178	17452 167	17568 164	17659 166	17861 159
17160 181	17305 178	17454 168	17569 164	17660 164	17862 159
17165 179	17306 178	17455 161	17570 164	17661 164	17863 159
17167 179	17308 159	17455 168	17571 164	17662 164	17864 159
17169 179	17309 159	17456 168	17572 164	17663 164	17865 159
17170 179	17310 159	17458 168	17573 164	17664 164	17866 159
17172 178	17311 159	17459 168	17574 164	17665 164	17867 159
17175 180	17312 159	17460 164	17575 164	17666 164	17868 159
17177 180	17313 159	17461 164	17576 164	17667 164	17869 159
17178 172	17314 159	17462 164	17577 164	17668 164	17870 159
17180 172	17315 159	17463 164	17578 164	17669 164	17871 159
17181 172	17316 159	17464 164	17579 164	17670 164	17872 159
17182 45	17317 159	17465 164	17580 164	17671 164	17873 159
17182 137	17318 159	17467 164	17581 164	17672 164	17874 159
17183 45	17319 159	17468 164	17582 164	17674 164	17875 159
17183 137	17320 159	17469 164	17583 164	17675 164	17876 159
17185 181	17321 159	17470 164	17584 164	17676 164	17877 159
17186 180	17322 159	17471 164	17585 164	17677 164	17878 159
17187 181	17324 159	17472 164	17586 164	17678 164	17879 159
17188 181	17327 159	17473 164	17587 164	17679 164	17880 159
17189 181	17330 159	17475 166	17589 164	17680 168	17881 159
17190 174	17332 159	17476 166	17590 164	17681 168	17882 159
17191 174	17333 159	17480 164	17591 164	17682 168	17883 159
17192 174	17334 159	17481 164	17592 164	17683 164	17884 159
17193 174	17338 167	17482 164	17593 164	17685 165	17885 159
17197 165	17341 178	17483 164	17600 167	17761 164	17886 159
17198 165	17342 178	17484 164	17601 167	17769 164	17887 159
17199 165	17350 162	17485 164	17603 167	17788 164	17888 159
17200 165	17351 162	17486 164	17605 164	17795 164	17889 159
17201 165	17352 162	17487 164	17606 164	17806 164	17890 159
17202 165	17353 162	17488 164	17607 164	17810 161	17891 159
17203 167	17357 162	17489 164	17608 164	17811 161	17892 159
17204 167	17359 162	17490 164	17609 164	17812 161	17895 159
17205 167	17361 162	17491 164	17610 164	17820 159	17896 159
17206 167	17380 161	17492 164	17611 164	17821 159	17897 159
17229 155	17381 161	17493 164	17612 164	17822 159	17898 159
17230 155	17382 160	17494 164	17613 164	17823 159	17904 159
17231 155	17383 160	17495 164	17614 164	17824 159	17905 159
17233 155	17384 160	17496 164	17615 164	17825 159	17907 159
17234 155	17385 160	17501 166	17616 164	17826 159	17910 159
17235 156	17386 160	17506 165	17617 164	17827 159	17914 159
17236 156	17390 160	17508 165	17619 165	17828 159	17916 159
17237 154	17391 160	17512 166	17620 166	17829 159	17922 159
17238 153	17392 160	17526 165	17621 166	17830 159	17924 159

Cikkszám	oldal	Cikkszám	oldal	Cikkszám	oldal	Cikkszám	oldal	Cikkszám	oldal	Cikkszám	oldal
17926	159	18302	143	18498	163	18638	147	18828	148	18971	160
17930	159	18303	143	18499	163	18639	147	18829	148	18993	150
17934	159	18304	143	18500	163	18640	147	18830	148	18994	150
17935	159	18310	140	18501	162	18641	147	18831	148	19001	197
17943	159	18311	140	18508	163	18645	147	18832	148	19002	197
17944	159	18312	140	18510	162	18646	147	18835	148	19003	197
17970	148	18313	140	18511	162	18680	147	18836	148	19004	197
17971	148	18321	140	18512	162	18685	147	18837	148	19005	197
17972	148	18322	140	18513	162	18710	146	18838	148	19006	197
17973	148	18340	141	18514	162	18711	146	18839	148	19008	197
17974	148	18350	140	18515	162	18712	146	18840	148	19010	197
17975	148	18351	140	18516	162	18715	146	18841	148	19015	197
17976	148	18352	140	18518	162	18716	146	18842	148	19020	197
17980	148	18353	140	18519	162	18717	146	18843	148	19021	195
17981	148	18354	140	18520	162	18720	146	18844	148	19022	195
17982	148	18355	140	18521	162	18721	146	18845	148	19023	195
17983	148	18356	140	18522	162	18722	146	18846	148	19024	195
18062	142	18357	140	18523	162	18723	146	18847	148	19025	195
18063	142	18358	140	18524	162	18724	146	18850	148	19026	195
18064	142	18359	140	18527	162	18725	146	18851	148	19028	195
18065	142	18360	140	18567	162	18750	147	18852	148	19030	195
18066	142	18400	143	18572	162	18751	147	18853	148	19031	195
18067	142	18401	143	18575	162	18753	147	18855	148	19032	195
18070	142	18402	141	18576	162	18755	147	18856	148	19034	195
18071	142	18403	141	18577	162	18760	147	18860	148	19036	195
18072	142	18404	141	18578	162	18761	147	18861	148	19041	195
18075	142	18408	145	18579	162	18762	147	18862	148	19042	195
18076	142	18409	145	18580	162	18763	147	18863	148	19043	195
18077	142	18410	142	18581	162	18764	147	18864	148	19044	195
18080	142	18411	142	18582	162	18765	147	18865	148	19045	195
18081	142	18413	142	18583	162	18766	147	18866	148	19046	195
18082	142	18415	144	18584	162	18767	147	18867	148	19050	197
18083	142	18416	144	18585	162	18768	147	18868	148	19051	197
18084	142	18417	144	18587	162	18769	147	18869	148	19052	197
18085	142	18418	143	18588	162	18770	147	18870	148	19053	197
18086	142	18419	144	18589	162	18771	147	18871	148	19054	197
18087	142	18420	144	18593	162	18772	147	18872	148	19055	197
18088	142	18421	152	18600	149	18775	147	18873	148	19056	197
18089	142	18422	141	18601	149	18776	147	18874	148	19057	197
18090	142	18423	142	18602	149	18777	147	18900	151	19058	195
18091	142	18424	141	18603	158	18795	149	18901	151	19059	195
18092	142	18425	140	18604	161	18796	149	18905	151	19060	196
18101	143	18426	145	18605	149	18797	149	18906	151	19061	196
18102	143	18427	145	18607	149	18798	149	18907	152	19062	196
18103	143	18428	115	18608	144	18799	149	18908	151	19063	196
18104	143	18429	115	18609	150	18800	148	18909	151	19064	196
18105	143	18430	152	18610	150	18801	148	18910	145	19065	196
18106	143	18431	144	18611	150	18802	148	18915	152	19066	195
18107	143	18432	146	18612	150	18803	148	18920	160	19067	195
18108	143	18433	144	18613	150	18804	148	18921	160	19068	195
18110	143	18434	140	18614	150	18805	148	18922	160	19069	195
18113	140	18435	145	18615	150	18806	148	18925	160	19070	195
18114	140	18437	145	18618	150	18807	148	18926	160	19071	195
18115	140	18440	152	18619	149	18810	148	18927	160	19074	195
18116	140	18445	173	18619	161	18811	148	18928	160	19075	195
18118	140	18450	143	18620	147	18812	148	18929	160	19076	195
18120	140	18451	143	18621	147	18813	148	18930	160	19077	195
18124	140	18455	143	18623	147	18814	148	18931	160	19081	195
18125	140	18456	143	18625	147	18815	148	18934	160	19082	195
18201	143	18460	143	18627	147	18816	148	18939	160	19083	195
18202	143	18476	162	18628	147	18817	148	18948	160	19084	195
18203	143	18490	163	18630	147	18820	148	18950	160	19085	195
18204	143	18491	163	18631	147	18821	148	18951	160	19086	195
18210	140	18492	163	18632	147	18822	148	18954	160	19088	195
18211	140	18493	163	18633	147	18823	148	18955	160	19090	195
18212	140	18494	162	18634	147	18824	148	18956	160	19092	195
18215	140	18495	162	18635	147	18825	148	18960	160	19095	195
18216	140	18496	163	18636	147	18826	148	18961	160	19096	195
18301	143	18497	163	18637	147	18827	148	18963	160	19097	195

Cikkszám	oldal	Cikkszám	oldal	Cikkszám	oldal	Cikkszám	oldal	Cikkszám	oldal	Cikkszám	oldal
19098	195	19394	317	19473	202	19580	56	19643	56	19704	57
19100	196	19395	317	19474	202	19585	56	19644	56	19705	57
19106	195	19396	317	19477	202	19585	56	19645	56	19705	57
19108	195	19397	317	19478	202	19586	56	19645	56	19706	57
19109	195	19398	197	19480	202	19587	56	19646	56	19707	57
19110	200	19399	197	19481	202	19588	56	19647	56	19708	57
19115	44	19400	201	19483	202	19589	56	19648	56	19708	57
19115	197	19400	251	19485	201	19590	56	19649	56	19709	57
19124	196	19401	201	19486	201	19590	56	19650	56	19710	57
19136	196	19401	251	19487	201	19591	56	19650	56	19711	57
19148	196	19402	201	19490	135	19593	56	19651	56	19711	57
19149	196	19402	251	19491	135	19594	56	19652	56	19712	57
19150	196	19403	201	19492	135	19595	56	19653	56	19713	57
19151	196	19403	251	19493	135	19595	56	19654	56	19713	57
19202	198	19404	201	19494	135	19596	56	19655	56	19714	57
19208	199	19404	251	19495	135	19597	56	19656	56	19715	57
19209	199	19405	201	19496	135	19598	56	19657	56	19716	57
19211	199	19405	251	19497	135	19599	56	19658	56	19717	57
19245	198	19406	201	19498	135	19600	56	19659	56	19718	57
19246	198	19406	251	19499	135	19600	56	19660	56	19718	57
19247	198	19407	201	19501	135	19601	56	19661	56	19719	57
19248	198	19407	251	19502	135	19603	56	19662	56	19720	57
19249	198	19408	201	19510	134	19604	56	19663	56	19721	57
19251	199	19408	251	19515	134	19605	56	19664	56	19722	57
19252	199	19409	201	19520	134	19605	56	19665	56	19723	57
19253	199	19409	251	19530	56	19606	56	19669	56	19723	57
19254	199	19410	201	19530	56	19607	56	19670	57	19724	57
19255	199	19411	201	19535	56	19608	56	19671	57	19725	57
19265	199	19412	201	19535	56	19609	56	19672	57	19726	57
19270	199	19415	200	19536	56	19610	56	19673	57	19727	57
19271	199	19416	200	19537	56	19610	56	19673	57	19728	57
19272	199	19418	201	19538	56	19611	56	19674	57	19728	57
19281	199	19419	201	19539	56	19612	56	19675	57	19729	57
19290	199	19420	200	19540	56	19613	56	19676	57	19730	57
19293	199	19421	200	19540	56	19614	56	19677	57	19731	57
19294	199	19422	200	19543	56	19615	56	19678	57	19732	57
19295	199	19423	200	19544	56	19615	56	19678	57	19733	57
19297	199	19424	200	19545	56	19616	56	19679	57	19733	57
19301	316	19425	200	19545	56	19617	56	19680	57	19734	57
19303	196	19426	200	19550	56	19618	56	19681	57	19735	57
19306	317	19427	200	19550	56	19619	56	19682	57	19736	57
19308	317	19429	201	19552	56	19620	56	19683	57	19737	57
19310	317	19430	197	19552	56	19620	56	19683	57	19738	57
19312	317	19431	197	19554	56	19621	56	19684	57	19738	57
19314	317	19432	197	19555	56	19622	56	19685	57	19739	57
19326	316	19433	197	19555	56	19623	56	19686	57	19740	57
19328	316	19434	197	19557	56	19624	56	19687	57	19741	57
19330	316	19435	197	19558	56	19625	56	19688	57	19742	57
19332	316	19436	201	19559	56	19625	56	19688	57	19743	57
19333	316	19440	197	19560	56	19626	56	19689	57	19743	57
19335	316	19441	197	19560	56	19627	56	19690	57	19744	57
19337	316	19442	197	19562	56	19628	56	19691	57	19745	57
19340	316	19443	197	19562	56	19629	56	19692	57	19746	57
19370	317	19450	135	19564	56	19630	56	19693	57	19747	57
19371	317	19451	135	19565	56	19630	56	19693	57	19748	57
19374	317	19455	135	19565	56	19631	56	19694	57	19748	57
19380	316	19457	135	19567	56	19632	56	19695	57	19749	57
19381	316	19458	135	19568	56	19633	56	19695	57	19750	57
19382	316	19459	135	19568	56	19634	56	19696	57	19751	57
19383	316	19460	201	19570	56	19635	56	19697	57	19752	57
19384	316	19460	251	19570	56	19635	56	19698	57	19753	57
19385	316	19462	317	19574	56	19636	56	19698	57	19753	57
19387	316	19463	317	19575	56	19637	56	19699	57	19754	57
19388	316	19464	317	19575	56	19638	56	19700	57	19755	57
19389	316	19465	317	19576	56	19639	56	19701	57	19756	57
19390	316	19469	317	19577	56	19640	56	19701	57	19757	57
19391	316	19470	201	19578	56	19640	56	19702	57	19758	57
19392	316	19470	251	19579	56	19641	56	19703	57	19758	57
19393	317	19472	202	19580	56	19642	56	19703	57	19759	57

Cikkszám	oldal	Cikkszám	oldal	Cikkszám	oldal	Cikkszám	oldal	Cikkszám	oldal	Cikkszám	oldal
19760	57	20300	59	20489	61	20751	67	20896	63	21110	75
19761	57	20305	59	20490	61	20752	67	20897	63	21111	75
19762	57	20310	59	20491	61	20753	67	20898	63	21112	75
19763	57	20311	59	20492	61	20754	67	20899	63	21115	75
19763	57	20315	60	20493	61	20755	67	20901	64	21118	75
19764	57	20316	59	20494	61	20756	67	20905	64	21123	75
19765	57	20317	59	20495	61	20757	67	20910	64	21130	75
19766	57	20320	60	20496	61	20758	67	20911	63	21135	75
19767	57	20321	60	20508	67	20759	67	20912	63	21140	75
19768	57	20333	58	20510	67	20760	67	20913	63	21150	75
19768	57	20334	58	20511	67	20761	67	20915	63	21180	75
19769	57	20335	58	20512	67	20762	67	20916	63	21190	75
19770	57	20336	58	20513	67	20764	67	20917	63	21192	77
19771	57	20337	58	20514	67	20765	67	20918	63	21194	77
19772	57	20338	58	20515	67	20766	67	20919	63	21195	75
19772	57	20340	60	20516	67	20767	67	20920	63	21200	74
19773	57	20350	202	20520	67	20768	67	20921	63	21201	74
19774	57	20360	139	20521	67	20769	67	20922	63	21203	74
19775	57	20361	139	20522	67	20770	67	20923	63	21204	74
19776	57	20363	180	20523	67	20771	67	20924	63	21205	74
19776	57	20364	180	20524	67	20772	67	20932	69	21209	74
19777	57	20365	29	20525	67	20773	67	20936	69	21210	75
19778	57	20379	29	20526	67	20774	67	20937	69	21211	75
19779	57	20380	60	20673	67	20775	67	20938	69	21212	75
19780	57	20381	64	20674	67	20776	67	20939	69	21215	75
19781	57	20385	62	20675	67	20777	67	20940	69	21218	75
19781	57	20386	62	20676	67	20778	67	20941	69	21219	75
19782	57	20387	62	20677	67	20779	67	20942	69	21220	75
19783	57	20390	62	20678	67	20780	67	20943	69	21223	75
19783	57	20391	62	20680	67	20781	67	20944	69	21224	75
19784	57	20394	62	20682	67	20782	67	20945	69	21230	74
19785	57	20395	62	20684	67	20783	67	20946	69	21231	74
19786	57	20396	62	20685	67	20784	67	20947	69	21234	74
19786	57	20397	62	20686	67	20785	67	20948	69	21235	74
19787	57	20400	58	20687	67	20786	67	20949	69	21238	74
19788	57	20401	58	20688	67	20787	67	20950	68	21301	75
19789	57	20402	58	20690	67	20788	67	20952	68	21303	75
19790	57	20403	58	20691	67	20789	67	20954	68	21306	77
19791	57	20404	58	20692	67	20790	67	20956	69	21308	77
19792	57	20405	58	20694	67	20791	67	20957	63	21311	75
19793	57	20406	58	20696	67	20792	67	20958	63	21312	75
19794	57	20407	58	20697	67	20793	67	20960	29	21315	75
19795	57	20408	58	20698	67	20794	67	20961	29	21318	75
19796	57	20409	58	20724	63	20795	67	20963	29	21323	75
19797	57	20410	58	20725	63	20796	67	20965	29	21324	75
19798	57	20411	58	20726	63	20797	67	20966	29	21326	75
19799	57	20412	58	20727	63	20798	67	20967	166	21327	75
19800	57	20413	58	20728	63	20799	67	20968	166	21411	75
19801	57	20414	58	20729	63	20805	68	20970	202	21412	75
19802	57	20415	58	20730	63	20820	68	20971	202	21415	75
19841	58	20416	58	20731	63	20825	67	20972	202	21418	75
19842	58	20417	58	20732	63	20855	67	20973	202	21423	75
19845	58	20418	58	20733	63	20861	67	20980	63	21424	75
19885	58	20419	58	20734	63	20862	67	20981	63	21425	76
19895	58	20420	58	20735	63	20870	67	20982	63	21426	76
20210	64	20421	58	20736	63	20871	67	20983	63	21427	76
20220	57	20422	58	20737	63	20872	67	20984	63	21428	76
20225	57	20423	58	20738	63	20873	67	20990	69	21430	76
20230	57	20424	58	20739	63	20874	67	20991	69	21431	76
20235	57	20425	58	20740	63	20875	67	20992	69	21432	76
20240	57	20426	58	20741	63	20876	67	20996	68	21435	76
20245	57	20427	58	20742	150	20877	67	20997	69	21436	76
20250	57	20428	58	20743	29	20878	67	20999	68	21437	76
20255	57	20429	58	20743	149	20879	67	21010	75	21440	64
20260	57	20430	58	20744	29	20880	67	21011	75	21441	64
20270	57	20450	64	20745	29	20881	67	21012	75	21442	64
20280	57	20460	64	20748	67	20890	68	21015	75	21443	64
20290	57	20487	61	20749	67	20891	68	21018	75	21444	64
20296	57	20488	61	20750	67	20895	68	21023	75	21445	64

Cikkszám	oldal	Cikkszám	oldal	Cikkszám	oldal	Cikkszám	oldal	Cikkszám	oldal	Cikkszám	oldal
21446	64	21803	78	22012	81	22083	82	22170	189	22277	76
21450	66	21804	78	22013	81	22084	82	22171	189	22280	76
21451	66	21805	78	22014	81	22085	82	22172	189	22281	76
21452	66	21806	78	22015	81	22086	187	22173	189	22285	76
21453	66	21807	65	22016	81	22087	83	22174	189	22286	76
21454	66	21807	78	22017	81	22088	82	22178	188	22294	76
21530	64	21808	65	22018	81	22090	82	22180	188	22300	86
21531	63	21808	78	22019	81	22091	83	22181	188	22301	86
21532	63	21809	79	22020	81	22092	83	22182	188	22302	86
21533	63	21810	84	22021	81	22093	83	22183	188	22303	86
21534	63	21811	84	22022	81	22095	82	22184	188	22305	86
21535	63	21812	84	22023	81	22096	84	22185	188	22307	86
21536	63	21813	84	22024	81	22097	84	22186	188	22309	86
21540	66	21814	84	22025	81	22098	84	22188	189	22310	86
21541	66	21831	84	22026	81	22099	84	22189	189	22311	86
21701	84	21832	84	22027	81	22100	85	22190	189	22312	86
21702	84	21834	84	22028	81	22101	85	22196	189	22313	86
21703	84	21850	85	22029	81	22102	85	22197	189	22314	86
21704	84	21851	85	22030	81	22103	85	22198	189	22315	86
21705	84	21852	85	22031	81	22104	85	22199	189	22316	86
21706	84	21853	85	22032	82	22105	85	22200	70	22317	86
21709	84	21854	85	22033	187	22106	85	22201	70	22318	86
21715	84	21855	85	22034	187	22107	85	22202	189	22319	86
21716	84	21856	85	22035	187	22108	85	22203	189	22320	86
21717	84	21857	85	22036	187	22109	85	22204	189	22322	86
21718	84	21858	85	22037	80	22110	85	22205	189	22324	86
21719	84	21859	85	22038	80	22111	85	22206	188	22326	86
21720	84	21860	85	22039	81	22112	85	22207	188	22328	86
21721	84	21861	85	22040	81	22113	85	22208	188	22329	86
21724	84	21862	85	22041	83	22115	85	22209	188	22332	86
21732	84	21863	85	22042	83	22116	85	22211	77	22333	86
21734	84	21864	85	22043	83	22117	85	22212	77	22335	86
21735	84	21900	80	22044	83	22119	85	22215	77	22337	86
21736	84	21901	80	22045	84	22120	293	22216	77	22340	86
21737	84	21902	80	22046	84	22121	293	22217	77	22343	86
21740	84	21903	80	22047	84	22122	293	22218	77	22345	86
21741	84	21904	80	22048	84	22123	293	22219	77	22350	86
21742	84	21905	80	22049	84	22124	293	22220	77	22351	86
21743	84	21906	80	22050	84	22125	293	22222	77	22355	86
21744	84	21907	80	22051	84	22126	293	22224	77	22357	86
21750	84	21908	80	22052	84	22129	293	22225	77	22365	86
21751	84	21909	81	22053	84	22130	293	22228	77	22370	86
21752	84	21910	81	22054	84	22132	293	22229	77	22398	86
21753	84	21911	80	22055	84	22133	293	22230	77	22399	86
21754	84	21912	80	22056	84	22134	293	22232	77	22510	56
21760	79	21913	80	22057	84	22135	350	22234	77	22515	56
21761	79	21914	80	22058	81	22136	350	22236	77	22520	56
21762	79	21920	80	22059	81	22137	350	22238	77	22525	56
21763	79	21925	80	22060	83	22138	350	22240	77	22530	56
21764	79	21926	80	22061	83	22140	79	22242	77	22532	56
21780	79	21930	82	22062	83	22141	79	22244	77	22535	56
21781	79	21931	82	22063	83	22142	79	22246	77	22540	56
21782	79	21935	82	22064	83	22143	79	22248	77	22542	56
21783	79	21936	82	22065	83	22145	79	22251	77	22545	56
21784	79	21937	82	22066	83	22146	79	22252	77	22548	56
21786	79	21940	82	22067	85	22147	79	22253	77	22550	56
21787	79	21941	82	22070	83	22148	79	22254	77	22555	56
21788	79	21950	81	22071	83	22150	79	22255	77	22560	56
21789	79	22001	80	22072	83	22151	79	22258	76	22565	56
21790	79	22002	80	22073	83	22155	79	22259	76	22568	56
21792	79	22003	80	22074	83	22156	79	22260	76	22570	56
21793	79	22004	80	22075	85	22158	187	22263	76	22575	56
21794	79	22005	80	22076	85	22159	187	22264	76	22580	56
21795	79	22006	80	22077	85	22160	83	22266	76	22585	56
21796	79	22007	80	22078	187	22161	83	22269	76	22590	56
21798	79	22008	80	22079	187	22162	83	22270	76	22595	56
21800	78	22009	80	22080	187	22163	83	22273	76	22600	56
21801	78	22010	80	22081	187	22164	83	22274	76	22602	56
21802	78	22011	80	22082	187	22167	83	22275	76	22605	56

Cikkszám	oldal	Cikkszám	oldal	Cikkszám	oldal	Cikkszám	oldal	Cikkszám	oldal	Cikkszám	oldal
22610	56	23658	209	23973	183	24111	190	24197	93	24676	72
22615	56	23660	210	23974	183	24114	191	24301	90	24677	72
22620	56	23661	209	23975	183	24115	191	24302	90	24678	72
22625	56	23664	209	23976	183	24118	93	24303	90	24680	276
22630	56	23670	203	23977	183	24119	93	24304	90	24690	202
22701	82	23671	203	23978	183	24120	93	24305	90	24691	202
22702	82	23672	203	23979	183	24121	190	24306	90	24695	202
22703	82	23673	203	23985	183	24122	190	24308	90	24700	72
22704	82	23674	203	23986	183	24124	190	24310	90	24701	72
22705	82	23675	203	23987	183	24125	190	24312	91	24702	72
22706	82	23676	203	23988	183	24126	190	24313	91	24703	72
22707	82	23677	203	23989	183	24128	193	24314	91	24704	72
23270	239	23678	203	24000	183	24130	192	24315	91	24705	72
23400	212	23679	203	24001	183	24131	192	24316	91	24706	65
23401	212	23680	203	24005	183	24132	134	24320	87	24710	73
23402	212	23681	203	24007	182	24133	192	24321	87	24712	65
23406	212	23682	203	24008	183	24134	191	24322	87	24713	65
23407	212	23683	203	24010	182	24135	192	24325	91	24714	65
23410	212	23684	203	24015	182	24136	192	24410	60	24715	65
23411	212	23685	203	24017	182	24137	192	24411	60	24716	65
23412	212	23730	168	24020	182	24140	192	24412	60	24717	69
23415	212	23731	168	24030	182	24141	192	24415	65	24718	69
23416	212	23732	168	24035	183	24142	192	24419	60	24719	69
23417	212	23734	168	24036	183	24143	191	24420	60	24720	65
23420	205	23735	168	24038	183	24144	191	24422	60	24721	65
23506	204	23736	168	24039	183	24145	191	24425	60	24722	65
23507	204	23760	185	24040	183	24147	191	24429	60	24723	69
23508	204	23761	185	24041	183	24148	192	24432	60	24725	70
23515	204	23762	185	24042	183	24149	191	24435	60	24726	70
23520	204	23763	185	24043	183	24150	192	24437	60	24727	290
23525	204	23764	185	24045	89	24151	192	24444	60	24728	290
23530	204	23800	184	24050	91	24152	193	24451	60	24729	290
23531	204	23840	322	24055	88	24152	315	24457	60	24730	69
23551	204	23845	323	24055	277	24153	190	24464	60	24731	69
23560	204	23846	323	24060	88	24155	194	24468	60	24732	69
23561	204	23847	323	24061	88	24156	194	24476	60	24734	73
23562	204	23875	223	24062	88	24158	194	24483	60	24735	70
23563	204	23875	357	24063	88	24159	194	24620	71	24736	70
23564	204	23904	185	24064	88	24159	293	24621	71	24737	70
23565	204	23906	185	24065	88	24160	93	24622	71	24738	70
23566	204	23908	185	24066	88	24161	93	24623	71	24739	70
23570	203	23910	185	24067	88	24162	93	24624	71	24740	70
23571	203	23912	185	24068	88	24163	93	24627	71	24741	70
23572	203	23914	185	24069	88	24164	93	24630	71	24743	70
23573	203	23920	184	24070	88	24165	93	24633	71	24745	70
23574	203	23922	184	24071	88	24166	93	24636	71	24746	70
23585	203	23923	184	24072	88	24167	93	24638	71	24747	70
23587	203	23924	184	24073	88	24168	93	24640	71	24748	70
23589	203	23925	184	24074	88	24169	93	24642	71	24749	70
23591	203	23927	184	24075	88	24170	190	24643	71	24750	61
23595	204	23928	184	24076	88	24171	192	24647	79	24751	61
23598	204	23945	184	24077	88	24173	192	24648	79	24752	290
23600	205	23950	183	24078	88	24174	194	24649	79	24753	290
23601	205	23951	183	24080	89	24175	194	24650	72	24755	66
23602	205	23952	183	24081	89	24176	194	24651	71	24756	66
23605	205	23953	183	24082	89	24177	194	24652	71	24757	69
23607	205	23954	183	24083	89	24178	194	24655	73	24758	69
23620	205	23955	183	24084	89	24180	93	24658	73	24759	69
23625	203	23960	185	24085	89	24181	194	24661	72	24760	72
23626	203	23961	185	24086	89	24185	93	24663	72	24761	72
23628	203	23962	185	24087	89	24186	93	24665	82	24762	72
23630	203	23963	185	24098	89	24187	93	24666	82	24763	72
23632	203	23964	185	24099	89	24188	93	24667	82	24764	72
23635	203	23965	185	24100	190	24189	93	24670	72	24765	72
23637	204	23966	185	24102	190	24190	194	24671	72	24766	72
23650	210	23967	185	24104	190	24190	293	24672	72	24767	72
23652	208	23970	183	24108	93	24192	93	24673	72	24768	72
23655	210	23971	183	24109	93	24195	93	24674	72	24769	72
23657	208	23972	183	24110	190	24196	93	24675	72	24770	70

Cikkszám	oldal	Cikkszám	oldal	Cikkszám	oldal	Cikkszám	oldal	Cikkszám	oldal	Cikkszám	oldal
24771	70	25206	305	28032	11	31082	245	31502	252	32166	248
24772	70	25212	305	28035	13	31091	244	31503	252	32167	248
24773	70	25215	305	28040	12	31101	244	31505	247	32168	248
24774	70	25220	305	28045	12	31111	244	31506	247	32169	248
24775	71	25224	305	28050	14	31121	244	31507	247	32170	247
24776	72	25230	305	28055	14	31131	244	31510	247	32171	248
24777	71	25240	305	28060	17	31132	244	31511	247	32172	248
24778	71	25248	305	28061	17	31140	244	31512	247	32173	247
24779	72	25260	305	28065	17	31141	244	31513	247	32174	248
24780	73	25296	305	28070	10	31142	244	31514	247	32176	248
24781	73	25350	305	28075	15	31143	244	31515	247	32186	248
24782	73	25369	305	28076	18	31144	244	31517	247	32196	248
24783	73	25370	305	28080	19	31145	244	31519	252	32206	248
24784	73	25371	305	28081	19	31146	244	31520	249	32216	248
24785	73	25372	305	28083	19	31148	244	31521	249	32226	248
24786	73	25373	305	28085	19	31150	245	31522	249	32234	248
24787	73	25374	305	28086	19	31151	245	31523	249	32240	248
24788	73	25376	305	28090	20	31155	245	31524	249	32265	250
24789	73	25378	305	28101	21	31218	247	31541	249	32268	251
24790	72	25379	305	28102	20	31220	246	31551	249	32269	251
24791	72	25380	305	28103	20	31221	246	31552	249	32270	250
24792	72	25400	305	28104	21	31222	246	31553	249	32273	250
24793	72	25410	305	28210	28	31231	246	31555	249	32283	250
24794	72	26028	111	28213	28	31232	246	31556	249	32285	250
24795	71	26201	113	28215	27	31233	246	31557	249	32293	250
24796	72	26203	112	28218	28	31234	246	31558	249	32295	251
24797	71	26204	113	28220	25	31235	246	31559	249	32296	251
24798	73	26205	112	28221	23	31270	246	31601	253	32297	251
24799	71	26209	114	28223	28	31271	246	31602	253	32298	251
25001	305	26211	113	28225	24	31280	246	31603	253	32301	251
25002	305	26216	114	28228	28	31281	246	31610	249	32302	251
25003	305	26217	114	28229	28	31320	247	31641	253	32311	255
25004	305	26218	114	28230	26	31322	247	31651	253	32312	254
25005	305	26219	114	28233	28	31330	246	31655	253	32313	251
25006	305	26520	115	28240	36	31332	246	32001	250	32314	254
25009	305	26521	115	28267	29	31334	246	32002	250	32315	255
25012	305	26705	228	28275	50	31340	246	32003	250	32316	255
25015	305	26706	228	28278	50	31341	246	32013	250	32317	254
25016	305	26707	228	28280	50	31343	246	32014	250	32318	255
25020	305	26720	228	28282	50	31360	246	32015	250	32319	255
25024	305	26721	228	28340	37	31362	246	32016	250	32320	254
25025	305	26722	228	28342	37	31380	246	32018	250	32321	255
25030	305	26730	272	28345	37	31382	246	32020	250	32322	255
25040	305	26731	272	28346	37	31390	246	32021	250	32323	255
25048	305	26735	272	30003	256	31392	246	32022	253	32324	255
25060	305	26736	272	30003	259	31400	246	32023	253	32325	255
25096	305	26740	273	30004	256	31402	246	32024	250	32326	255
25150	305	26775	292	30004	259	31403	246	32026	250	32327	254
25153	305	26780	273	30005	256	31404	246	32037	251	32328	255
25155	305	26781	273	30005	259	31452	253	32038	251	32329	254
25160	305	26782	273	30007	256	31453	253	32040	253	32330	255
25162	305	26783	273	30007	259	31454	253	32041	253	32331	255
25163	305	26973	216	31005	245	31455	247	32042	253	32332	254
25164	305	26974	216	31006	245	31456	247	32043	253	32333	254
25167	305	26975	216	31007	245	31461	248	32044	253	32335	255
25169	305	26976	216	31008	245	31467	248	32050	253	32337	254
25170	305	26977	216	31009	245	31468	248	32051	253	32338	254
25171	305	28000	4	31011	245	31471	248	32052	253	33168	254
25179	305	28001	5	31021	245	31481	248	32053	253	33275	296
25180	305	28002	5	31031	245	31491	248	32060	250	34005	256
25181	305	28003	6	31041	245	31493	248	32062	250	34006	256
25182	305	28004	6	31051	245	31494	248	32064	250	34007	256
25183	305	28005	7	31052	245	31495	248	32066	250	34027	255
25184	305	28006	7	31053	245	31496	248	32089	251	34028	255
25186	305	28007	8	31061	245	31497	252	32161	248	34033	260
25188	305	28008	8	31062	245	31498	248	32162	248	34041	256
25189	305	28021	9	31071	245	31499	248	32163	248	34051	256
25190	305	28025	9	31072	245	31500	248	32164	248	34053	256
25195	305	28030	11	31081	245	31501	252	32165	248	34061	256

Cikkszám	oldal	Cikkszám	oldal	Cikkszám	oldal	Cikkszám	oldal	Cikkszám	oldal	Cikkszám	oldal
34071	256	34405	258	35082	263	35345	40	36130	277	37115	291
34081	256	34406	259	35085	262	35345	286	36136	277	37117	278
34091	256	34407	259	35086	262	35346	41	36138	277	37119	291
34101	256	34409	259	35087	262	35346	288	36139	277	37120	291
34111	256	34410	259	35091	262	35347	41	36140	277	37121	296
34115	256	34411	259	35092	262	35347	288	36145	274	37122	296
34116	256	34412	259	35093	262	35348	40	36160	274	37123	364
34117	256	34413	259	35094	263	35348	286	36175	274	37124	364
34121	256	34414	259	35095	263	35360	46	36190	274	37125	282
34122	256	34415	258	35096	263	35361	46	36191	274	37126	282
34132	256	34416	258	35103	264	35362	46	36195	277	37127	282
34142	256	34417	259	35113	264	35500	266	36199	274	37129	364
34152	256	34418	259	35123	264	35501	266	36200	274	37130	281
34153	256	34419	258	35125	264	35502	266	36300	209	37131	281
34154	256	34420	258	35126	264	35503	266	36308	292	37132	281
34155	256	34421	259	35127	264	35504	266	36310	273	37135	231
34156	256	34422	259	35142	262	35505	266	36312	292	37139	231
34157	256	34423	259	35300	38	35506	266	36318	283	37140	231
34158	256	34424	259	35300	261	35507	266	36319	283	37141	231
34159	256	34425	259	35305	39	35508	266	36325	283	37142	231
34160	256	34426	259	35305	262	35510	266	36326	16	37143	231
34200	252	34428	259	35310	38	35511	266	36326	283	37144	231
34201	252	34429	259	35310	261	35512	266	36328	16	37145	231
34202	252	34439	258	35311	38	35514	266	36329	16	37148	282
34203	252	34440	258	35311	261	35515	266	36410	208	37149	282
34221	260	34441	258	35315	39	35516	266	37005	302	37150	282
34223	260	34442	258	35315	262	35517	266	37006	279	37151	282
34231	260	34443	258	35316	38	35518	267	37006	279	37152	282
34235	260	34445	258	35316	261	35519	267	37007	279	37153	282
34237	260	34446	258	35317	38	35524	267	37007	279	37154	282
34238	260	34447	258	35317	261	35525	267	37008	279	37155	280
34241	260	34448	259	35318	38	35527	267	37009	279	37156	280
34243	260	34449	258	35318	261	35532	267	37011	278	37157	280
34251	260	34450	258	35319	38	35533	267	37012	279	37158	282
34261	260	34451	258	35319	261	35539	267	37021	278	37162	281
34262	260	34452	259	35320	50	35540	267	37025	278	37166	273
34265	260	34453	258	35322	50	35542	267	37025	278	37170	281
34271	252	34454	258	35323	42	35552	267	37026	278	37171	281
34272	252	34455	259	35323	289	35553	267	37026	278	37172	281
34273	252	34456	259	35325	42	35555	267	37028	278	37173	282
34274	252	34457	259	35325	289	35603	269	37028	278	37174	282
34275	252	34458	259	35326	42	35604	269	37029	278	37175	281
34276	252	34480	258	35326	289	35605	269	37029	278	37176	281
34280	252	34481	258	35327	42	35833	52	37031	253	37177	282
34281	252	34482	258	35327	289	35845	52	37041	253	37178	282
34282	252	34485	258	35328	42	35850	52	37050	278	37185	281
34283	252	34486	258	35328	42	36014	276	37051	253	37186	281
34284	252	34490	259	35328	289	36024	276	37052	278	37187	281
34285	252	34491	259	35328	289	36034	276	37053	278	37188	281
34300	292	34496	259	35329	42	36035	276	37054	278	37189	281
34301	252	34500	260	35329	42	36036	276	37055	278	37190	281
34303	292	35006	263	35329	289	36046	276	37065	284	37192	281
34304	252	35007	263	35329	289	36056	277	37066	284	37195	282
34305	252	35011	264	35330	40	36057	277	37067	284	37196	282
34305	292	35012	263	35330	287	36058	277	37068	284	37197	282
34306	252	35013	263	35331	41	36059	277	37069	284	37198	282
34306	292	35015	264	35331	288	36076	275	37070	284	37199	282
34307	252	35021	264	35332	41	36077	275	37094	284	37200	280
34307	292	35023	262	35332	288	36080	275	37095	284	37201	280
34308	252	35038	262	35333	41	36081	275	37096	284	37202	280
34308	292	35048	264	35333	288	36082	275	37097	284	37203	280
34315	293	35058	262	35334	41	36085	275	37098	284	37204	280
34316	131	35059	263	35334	288	36086	275	37101	253	37205	280
34316	293	35068	264	35335	42	36087	275	37102	280	37210	280
34400	258	35069	263	35335	289	36102	275	37105	280	37211	280
34401	258	35070	263	35336	41	36103	275	37106	280	37212	280
34402	259	35078	263	35336	288	36105	275	37107	280	37216	291
34403	259	35079	263	35344	41	36126	277	37111	253	37217	291
34404	258	35081	263	35344	287	36128	277	37114	291	37218	291

37220	280	37344	236	38022	299	38949	224	39217	290	42179	353
37230	292	37345	236	38024	297	38950	290	39218	290	42180	354
37231	292	37350	235	38025	298	38951	290	39219	290	42181	354
37232	292	37500	267	38026	279	38952	290	39238	292	42182	354
37233	292	37501	267	38027	297	38953	290	39240	290	42185	354
37234	292	37505	267	38028	297	38954	290	39241	290	42186	354
37235	292	37506	267	38030	299	38955	224	39242	290	42187	354
37236	291	37509	268	38031	299	38956	224	39243	290	42188	354
37237	291	37510	268	38032	297	38957	224	39244	290	42190	224
37238	291	37511	268	38042	279	38958	224	39245	292	42190	354
37239	291	37512	268	38045	279	38959	224	40050	353	42201	355
37243	303	37515	268	38050	223	38960	224	40051	353	42202	355
37244	303	37516	268	38052	223	38961	224	40052	353	42203	355
37245	303	37517	268	38054	223	38963	226	40053	353	42207	355
37246	303	37518	268	38055	223	38964	225	40054	353	42208	355
37247	303	37527	268	38060	223	38965	225	40055	353	42209	355
37248	303	37530	268	38063	223	38966	225	40056	353	42210	355
37250	303	37532	268	38065	223	38968	224	40057	353	42211	355
37251	303	37533	268	38095	223	38969	226	40058	353	42212	355
37252	303	37539	269	38096	223	38970	290	40059	353	42213	355
37253	303	37541	269	38097	223	38971	290	40060	353	42214	355
37255	225	37545	307	38895	284	38972	226	40075	353	42217	355
37256	225	37546	307	38896	284	38973	226	40076	353	42218	355
37257	225	37549	210	38899	284	38975	226	40077	353	42219	355
37258	225	37553	212	38900	284	38980	224	40100	352	42220	355
37259	225	37560	209	38901	285	38981	224	40120	352	42221	355
37263	225	37564	269	38902	285	38985	226	41050	352	42228	355
37264	225	37570	192	38903	285	38990	225	41080	352	42229	355
37266	225	37570	209	38904	285	38991	225	41081	352	42230	355
37267	225	37611	53	38905	285	38995	225	41082	352	42244	355
37268	225	37615	53	38906	285	39000	296	41083	352	42248	355
37270	225	37616	53	38907	284	39001	296	41100	352	42249	355
37271	225	37647	218	38908	284	39002	296	41101	352	42251	355
37272	225	37660	306	38909	284	39003	296	41102	352	42252	355
37273	225	37730	53	38910	285	39005	296	41103	352	42253	355
37275	225	37731	53	38911	285	39010	296	41120	352	42255	355
37280	226	37732	53	38912	285	39012	296	41121	352	42256	355
37281	226	37733	53	38913	285	39014	296	41122	352	42257	355
37285	282	37740	53	38914	285	39020	296	41123	352	42260	355
37286	282	37741	53	38915	285	39021	296	41150	352	42261	355
37287	282	37744	53	38916	285	39045	296	41151	352	42312	291
37288	282	37745	53	38917	285	39065	296	41152	352	42312	354
37289	282	37746	53	38918	285	39090	296	41153	352	42365	222
37290	303	37747	53	38919	279	39145	296	42101	352	42366	222
37291	303	37750	53	38920	279	39165	296	42102	352	42367	222
37295	226	37751	53	38923	279	39190	296	42103	352	42368	222
37296	226	37760	53	38924	225	39192	296	42115	291	42420	291
37297	226	37761	53	38925	224	39192	323	42120	291	43050	358
37300	235	38000	298	38926	226	39193	296	42150	353	43058	358
37301	235	38001	297	38927	224	39193	323	42151	353	43060	358
37302	235	38002	298	38928	225	39194	223	42152	353	43068	358
37303	235	38003	298	38929	225	39195	223	42153	353	43071	358
37308	236	38004	299	38930	226	39196	223	42155	353	43072	358
37309	236	38005	299	38931	224	39197	223	42156	353	43077	358
37310	235	38006	298	38932	224	39198	223	42157	353	43082	358
37311	235	38007	298	38933	226	39199	223	42158	353	43083	358
37317	313	38008	298	38934	225	39200	223	42160	353	43084	358
37320	235	38009	298	38935	226	39201	223	42161	353	43086	358
37321	235	38010	298	38937	226	39202	223	42162	353	43087	359
37325	234	38012	297	38939	226	39203	223	42163	353	43089	359
37326	234	38013	297	38940	226	39204	223	42170	354	43090	359
37328	234	38014	299	38941	226	39205	223	42171	354	43094	359
37330	234	38014	299	38942	225	39206	290	42172	354	43097	358
37331	234	38015	299	38943	226	39207	290	42173	354	43098	359
37332	234	38016	299	38944	224	39208	290	42174	354	43099	359
37340	236	38017	299	38945	224	39210	290	42175	353	43300	347
37341	236	38018	299	38946	224	39212	290	42176	353	43301	347
37342	236	38020	298	38947	224	39214	290	42177	353	44041	322
37343	236	38021	299	38948	224	39216	290	42178	353	44042	322

Cikkszám	oldal	Cikkszám	oldal	Cikkszám	oldal	Cikkszám	oldal	Cikkszám	oldal	Cikkszám	oldal
44043	322	45034	319	45099	310	45178	333	45268	335	45391	324
44050	322	45035	318	45100	334	45179	331	45269	335	45392	324
44053	319	45036	322	45101	334	45180	327	45270	39	45393	324
44950	131	45038	319	45102	334	45181	327	45271	39	45394	324
44950	315	45039	319	45104	334	45182	333	45280	334	45395	324
44955	319	45040	319	45105	334	45183	333	45283	334	45396	325
44960	323	45041	319	45106	334	45184	331	45285	334	45397	325
44965	338	45042	319	45107	334	45185	331	45286	334	45398	325
44970	313	45043	323	45108	334	45186	331	45287	334	45399	325
44971	313	45044	322	45110	326	45187	332	45289	329	45400	325
44972	310	45045	136	45111	327	45190	332	45290	329	45401	325
44980	310	45045	320	45112	327	45191	332	45291	329	45450	357
44980	310	45046	136	45113	327	45192	332	45292	329	45451	357
44980	311	45046	320	45114	327	45193	332	45293	329	45452	357
44981	310	45047	323	45115	327	45194	332	45294	328	45453	357
44981	310	45048	136	45116	326	45195	332	45295	328	45460	357
44981	311	45048	312	45117	326	45196	332	45296	328	45461	357
44981	311	45048	320	45118	326	45197	332	45297	328	45462	357
44982	310	45049	322	45120	327	45198	332	45298	328	45463	357
44982	310	45050	338	45122	327	45199	332	45299	328	45465	357
44982	311	45051	338	45123	326	45200	332	45300	333	45466	357
44983	310	45052	338	45124	326	45203	332	45301	333	45467	357
44983	310	45053	339	45125	326	45204	332	45320	339	45470	357
44983	311	45054	339	45126	326	45206	332	45321	339	45471	226
44984	311	45055	339	45130	329	45211	332	45323	337	45471	323
44984	312	45056	318	45131	329	45213	328	45323	348	45472	323
44984	312	45057	318	45132	329	45214	327	45325	337	45473	323
44985	311	45058	318	45133	329	45215	329	45326	337	45480	357
44985	312	45059	318	45134	330	45216	328	45326	337	45485	357
44991	311	45060	193	45135	329	45217	329	45327	337	45490	314
44992	311	45060	315	45136	329	45218	328	45328	337	45496	357
44995	314	45061	193	45137	329	45219	329	45329	337	45497	357
44996	312	45061	315	45138	328	45220	334	45330	337	45498	357
44997	312	45062	193	45139	328	45221	334	45330	350	45499	357
44998	312	45062	315	45140	328	45222	334	45331	337	45500	321
44999	313	45063	310	45141	328	45223	334	45331	350	45502	321
45000	314	45065	318	45142	328	45224	334	45341	333	45503	321
45001	314	45066	318	45143	328	45225	334	45342	333	45505	321
45002	314	45067	318	45144	329	45226	334	45343	333	45506	321
45003	314	45068	136	45145	329	45227	334	45344	333	45508	321
45005	314	45068	312	45146	330	45228	334	45345	333	45509	321
45006	314	45068	320	45147	331	45229	334	45346	333	45511	321
45007	314	45069	131	45150	331	45239	336	45347	333	45512	321
45008	314	45069	315	45151	331	45240	336	45348	333	45513	321
45009	314	45070	340	45152	330	45241	336	45349	333	45515	321
45010	312	45071	338	45153	330	45242	336	45350	333	45516	321
45011	313	45073	136	45154	330	45244	335	45351	333	45517	321
45012	313	45073	320	45155	330	45245	335	45352	333	45518	321
45014	312	45074	323	45156	331	45246	335	45353	333	45519	321
45015	313	45079	319	45158	330	45247	335	45354	333	45520	321
45016	313	45080	319	45159	331	45248	335	45370	136	45521	321
45017	311	45081	131	45160	331	45249	335	45370	320	45522	321
45018	312	45081	315	45161	331	45250	335	45372	325	45523	321
45019	312	45082	131	45162	330	45251	335	45372	333	45524	321
45020	310	45082	315	45163	330	45253	335	45373	325	45525	321
45021	312	45083	131	45164	331	45254	335	45373	333	45526	321
45023	310	45083	315	45167	330	45256	335	45374	325	45527	321
45025	313	45084	131	45168	331	45257	335	45374	333	45528	321
45026	312	45084	315	45169	331	45260	335	45375	325	45529	321
45027	313	45085	319	45170	336	45261	335	45375	333	45530	321
45029	313	45086	323	45171	336	45262	335	45376	325	45531	321
45030	193	45088	311	45172	336	45262	335	45376	333	45532	321
45030	315	45089	311	45172	336	45263	335	45377	325	45533	321
45031	193	45093	323	45173	336	45263	335	45377	333	45534	321
45031	315	45094	311	45173	336	45265	335	45385	324	45535	322
45032	193	45095	310	45174	333	45266	335	45386	324	45540	321
45032	315	45096	310	45175	332	45267	335	45388	324	45541	321
45033	193	45097	311	45176	333	45267	335	45389	324	45542	321
45033	315	45098	310	45177	333	45268	335	45390	324	45543	321

45550	321	45660	322	48094	49	50544	233	51244	227	52055	307
45551	321	45661	322	48095	49	50549	232	51245	227	52060	307
45552	321	45662	322	48096	49	50550	230	51246	227	52065	307
45553	321	45663	322	48097	49	50551	230	51247	227	52070	300
45555	322	45664	322	48410	306	50553	230	51258	227	52071	300
45556	321	45670	322	48411	306	50554	230	51259	227	52075	300
45557	321	45671	322	48415	306	50555	233	51260	227	52076	300
45558	321	45672	322	48420	306	50556	230	51261	227	52077	300
45559	321	45673	322	48452	307	50557	232	51262	227	52078	300
45560	322	48001	48	48453	307	50558	232	51264	227	52101	349
45562	321	48002	48	48454	307	50559	230	51271	227	52102	349
45563	321	48004	47	48455	307	50560	230	51272	227	52103	349
45564	321	48005	47	48456	307	50562	230	51273	227	52104	349
45565	321	48006	47	48457	307	50563	230	51274	227	52105	349
45570	354	48007	47	48719	273	50564	230	51275	227	52108	348
45571	354	48008	49	48729	269	50570	230	51276	227	52109	349
45572	354	48009	49	48730	269	50571	230	51278	227	52113	349
45573	354	48010	48	48731	269	50585	233	51280	227	52114	349
45580	354	48011	48	50030	355	50585	303	51281	227	52115	349
45600	334	48013	15	50031	355	50586	233	51282	227	52116	349
45601	334	48013	48	50032	355	50586	303	51283	227	52119	348
45602	334	48015	47	50033	355	50587	233	51284	227	52126	350
45603	334	48020	46	50035	228	50587	303	51286	227	52130	280
45604	334	48021	46	50035	355	50588	233	51287	227	52135	348
45605	334	48022	46	50036	228	50588	303	51288	227	52160	349
45606	334	48030	47	50036	355	51100	228	51300	227	52161	349
45607	334	48031	48	50037	355	51102	228	51301	227	52162	349
45608	334	48032	48	50038	355	51103	228	51302	227	52163	349
45609	334	48033	48	50040	355	51104	228	51303	227	52164	349
45610	334	48034	48	50041	355	51105	228	51304	227	52168	348
45611	334	48036	47	50042	355	51106	228	51305	227	52173	348
45612	334	48037	47	50050	222	51107	228	51306	227	52175	348
45613	334	48040	48	50050	222	51108	228	51307	227	52176	348
45614	334	48041	48	50051	222	51109	228	51308	227	52185	349
45615	334	48042	48	50052	222	51110	228	51320	227	52186	349
45616	334	48043	48	50052	222	51111	228	51321	227	52187	349
45617	334	48046	46	50100	227	51120	228	51322	227	52188	349
45618	334	48046	49	50101	227	51121	228	51323	227	52189	349
45619	334	48047	46	50102	227	51122	228	51324	227	52190	349
45620	334	48047	49	50103	227	51123	228	51325	227	52191	349
45621	334	48050	49	50104	227	51124	228	51327	227	52192	349
45622	334	48051	49	50106	227	51125	228	51341	227	52193	349
45623	334	48054	49	50108	227	51126	228	51402	228	52194	349
45624	334	48055	49	50500	233	51127	228	51403	228	52195	349
45625	334	48056	49	50503	233	51130	228	51404	228	52196	349
45626	334	48057	49	50510	230	51131	228	51405	228	52197	348
45627	334	48060	49	50511	230	51132	228	51406	228	52198	348
45628	334	48061	49	50512	230	51196	228	51407	228	52202	300
45629	334	48062	49	50513	230	51197	228	51408	228	52203	300
45630	334	48063	49	50514	230	51198	228	51410	228	52204	300
45631	334	48064	49	50518	232	51199	228	51412	228	52205	300
45632	334	48065	49	50519	232	51204	227	51413	228	52206	300
45633	334	48066	49	50520	232	51205	227	51414	228	52207	300
45634	334	48067	49	50522	232	51206	227	51415	228	52208	300
45635	334	48068	49	50524	232	51207	227	51416	228	52212	300
45636	334	48070	49	50525	232	51208	227	51417	228	52213	300
45637	334	48071	49	50526	232	51209	227	51418	228	52214	300
45638	334	48072	49	50527	233	51210	227	51418	228	52215	300
45639	334	48075	49	50529	232	51211	227	51420	228	52216	300
45650	322	48076	49	50531	233	51212	227	51430	228	52217	300
45651	322	48077	49	50532	233	51220	227	51432	228	52218	300
45652	322	48080	49	50533	232	51221	227	51433	228	52220	300
45653	322	48081	49	50535	232	51222	227	51435	228	52283	300
45654	322	48085	49	50536	232	51225	227	51436	228	52284	300
45655	322	48086	49	50537	232	51226	227	51450	228	52285	300
45656	322	48087	49	50539	232	51227	227	52011	249	52286	300
45657	322	48090	49	50540	233	51241	227	52011	303	52288	300
45658	322	48091	49	50541	233	51242	227	52030	252	52305	301
45659	322	48093	49	50542	233	51243	227	52050	307	52306	301

Cikkszám	oldal	Cikkszám	oldal	Cikkszám	oldal	Cikkszám	oldal	Cikkszám	oldal	Cikkszám	oldal
52328	301	55356	229	61003	344	61098	345	61236	217	70025	44
52331	301	55357	229	61004	344	61098	351	61240	197	70026	44
52334	301	55358	229	61005	341	61111	346	61250	351	70030	44
52391	301	55359	229	61005	351	61112	346	61251	319	70031	44
52421	301	55360	229	61006	341	61114	346	61251	351	70032	44
52424	301	55361	229	61006	351	61120	346	61252	351	70033	44
52428	301	55362	229	61007	341	61121	346	61253	351	70035	44
52456	301	55400	356	61008	341	61130	338	61254	351	70036	44
52471	301	55401	356	61009	345	61131	338	61255	351	70037	44
52600	302	55402	356	61010	341	61132	339	61256	351	70040	43
52601	302	55403	356	61012	345	61133	339	61290	346	70060	44
52602	302	55404	356	61013	344	61134	339	61291	346	70061	44
52605	302	55405	356	61014	345	61135	339	61292	346	70062	44
52610	302	55406	356	61015	341	61141	339	61293	346	70063	44
52611	248	55420	356	61018	345	61142	340	61294	318	70064	43
52612	248	55421	356	61019	344	61143	340	61295	318	70065	44
52620	302	55422	356	61020	342	61144	340	61296	318	70066	43
52625	302	55423	356	61021	342	61145	340	61297	318	70070	44
52630	302	55424	356	61022	343	61146	340	61299	356	70075	44
52635	302	55425	356	61024	343	61150	338	61300	356	70090	45
52640	302	55429	356	61025	342	61155	341	61301	356	70091	45
52645	302	55430	356	61026	342	61156	341	61302	356	70092	45
52652	302	55431	356	61027	343	61157	341	61320	197	70093	45
52656	302	55432	356	61028	345	61158	341	61321	197	70094	45
52662	302	55433	356	61029	341	61161	344	61322	197	70095	45
52666	302	55436	356	61030	340	61162	344	61323	197	70096	45
52671	302	55437	356	61031	340	61163	344	61324	197	70098	210
52694	302	55450	356	61032	340	61164	345	61325	197	81011	361
52695	302	55452	356	61033	340	61165	345	61326	197	81012	361
54008	303	55453	356	61034	340	61166	345	61327	197	81013	361
55040	229	55454	356	61035	346	61169	251	61328	197	81014	361
55050	229	55455	356	61036	346	61171	350	61329	197	81015	361
55051	229	55456	356	61038	346	61172	348	61330	197	81016	361
55060	229	55457	356	61040	346	61172	350	61331	197	81022	361
55080	229	55460	356	61042	346	61173	350	61340	317	81023	361
55100	229	55461	356	61044	345	61174	350	61341	317	81024	361
55120	229	55462	356	61045	340	61175	350	61342	317	81025	361
55140	229	55465	356	61046	340	61176	350	61343	317	81035	361
55160	229	55640	229	61047	340	61177	350	61344	317	81036	361
55180	229	55642	229	61048	340	61183	351	61345	317	81053	364
55181	229	55645	229	61050	342	61184	351	61346	317	81054	364
55200	229	55650	229	61050	351	61189	351	65062	307	81057	364
55201	229	60001	347	61051	342	61190	351	65063	307	81070	364
55220	229	60006	347	61051	351	61192	350	65064	307	81071	364
55221	229	60008	347	61052	343	61193	350	65065	307	81077	364
55240	229	60012	347	61052	351	61194	350	69900	294	81100	364
55300	229	60018	347	61053	343	61195	351	69901	294	81101	364
55315	229	60019	347	61054	343	61200	350	69902	294	81102	364
55316	229	60020	347	61056	342	61201	347	69903	294	81103	364
55317	229	60022	347	61057	342	61201	350	69904	295	81104	364
55318	229	60100	251	61058	343	61202	350	69905	294	81105	364
55319	229	60115	273	61059	343	61203	345	69906	294	81106	364
55331	229	60116	273	61060	340	61204	351	69907	295	81150	362
55332	229	60117	273	61061	340	61205	351	69908	295	81151	362
55333	229	60118	273	61062	340	61207	351	69909	295	81152	362
55334	229	60121	273	61063	340	61208	350	69910	295	81155	362
55335	229	60123	273	61067	346	61209	345	69911	295	81160	362
55336	229	60125	272	61068	346	61215	351	69912	295	81165	362
55337	229	60130	272	61069	346	61218	251	69914	294	81170	362
55339	229	60132	272	61070	346	61219	351	69917	295	81175	362
55340	229	60155	272	61077	351	61221	318	69918	294	81178	362
55341	229	60157	272	61079	351	61221	318	69919	294	81180	362
55342	229	60201	347	61079	351	61221	318	69920	295	81185	362
55350	229	60206	347	61085	319	61221	318	69923	295	81186	362
55351	229	60208	347	61088	342	61222	345	69928	295	81188	362
55352	229	60212	347	61089	342	61223	344	69930	296	81189	362
55353	229	61000	342	61090	343	61224	346	69931	296	81190	362
55354	229	61001	342	61097	344	61224	346	70020	44	81191	362
55355	229	61002	343	61097	351	61230	351	70021	44	81195	361

Cikkszám oldal	Cikkszám oldal	Cikkszám oldal	Cikkszám oldal	Cikkszám oldal	Cikkszám oldal				
81196	361	81267	363	81337	363	81408	363	82103	307
81197	361	81268	363	81338	363	81409	363	82104	307
81200	363	81269	363	81339	363	81410	363	89775	51
81201	363	81270	363	81340	363	81411	363	89970	51
81202	363	81271	363	81341	363	81412	363	89973	51
81203	363	81272	363	81342	363	81413	363	89975	51
81204	363	81273	363	81343	363	81414	363	89980	51
81205	363	81274	363	81344	363	81415	363	89985	51
81206	363	81275	363	81345	363	81416	363	89987	51
81207	363	81276	363	81346	363	81417	363	89988	51
81208	363	81277	363	81347	363	81418	363	89989	51
81209	363	81278	363	81348	363	81419	363	89990	51
81210	363	81279	363	81349	363	81420	363	90070	278
81211	363	81280	363	81350	363	81421	363	90071	278
81212	363	81281	363	81351	363	81422	363	90072	278
81213	363	81282	363	81352	363	81423	363	90191	56
81214	363	81284	363	81353	363	81424	363	90192	57
81215	363	81285	363	81354	363	81425	363	18610A	150
81216	363	81286	363	81355	363	81426	363	18611A	150
81217	363	81287	363	81356	363	81427	363	18612A	150
81218	363	81288	363	81357	363	81428	363	18613A	150
81219	363	81289	363	81358	363	81429	363	18614A	150
81220	363	81290	363	81359	363	81430	363	18615A	150
81221	363	81291	363	81360	363	81431	363	18632A	147
81222	363	81292	363	81361	363	81432	363	18633A	147
81223	363	81293	363	81362	363	81433	363	18636A	147
81224	363	81294	363	81363	363	81434	363	18637A	147
81225	363	81295	363	81364	363	81435	363	18638A	147
81226	363	81296	363	81365	363	81436	363	18827A	147
81227	363	81297	363	81366	363	81437	363	18828A	147
81228	363	81298	363	81367	363	81438	363	18830A	147
81229	363	81299	363	81370	363	81439	363	18831A	147
81230	363	81300	363	81371	363	81440	363	81011A	361
81231	363	81301	363	81372	363	81441	363	81011F	361
81232	363	81302	363	81373	363	81442	363	81011G	361
81233	363	81303	363	81374	363	81443	363	81011H	361
81234	363	81304	363	81375	363	81444	363	81011R	361
81235	363	81305	363	81376	363	81445	363	M90203	365
81236	363	81306	363	81377	363	81447	363	M90204	365
81237	363	81307	363	81378	363	81448	363	M90205	365
81238	363	81308	363	81379	363	81449	363	M90206	365
81239	363	81309	363	81380	363	81450	363	M90207	365
81240	363	81310	363	81381	363	81451	363	M90210	365
81241	363	81311	363	81382	363	81452	363	M90220	365
81242	363	81312	363	81383	363	81453	363	M90221	365
81243	363	81313	363	81384	363	81454	363	M90222	365
81244	363	81314	363	81385	363	81455	363	M90400	365
81245	363	81315	363	81386	363	81456	363	M90403	365
81246	363	81316	363	81387	363	81457	363	M90519	365
81247	363	81317	363	81388	363	81458	363		
81248	363	81318	363	81389	363	81459	363		
81249	363	81319	363	81390	363	81460	363		
81250	363	81320	363	81391	363	81461	363		
81251	363	81321	363	81392	363	81462	363		
81252	363	81322	363	81393	363	81463	363		
81253	363	81323	363	81394	363	81466	363		
81254	363	81324	363	81395	363	81467	363		
81255	363	81325	363	81396	363	81468	363		
81256	363	81326	363	81397	363	81469	363		
81257	363	81327	363	81398	363	81470	363		
81258	363	81328	363	81399	363	81471	363		
81259	363	81329	363	81400	363	81472	363		
81260	363	81330	363	81401	363	81473	363		
81261	363	81331	363	81402	363	81486	363		
81262	363	81332	363	81403	363	81600	364		
81263	363	81333	363	81404	363	81603	364		
81264	363	81334	363	81405	363	82100	307		
81265	363	81335	363	81406	363	82101	307		
81266	363	81336	363	81407	363	82102	307		

ALKALMAZOTT PIKTOGRAMOK LISTÁJA

· TERMÉKLEÍRÁS

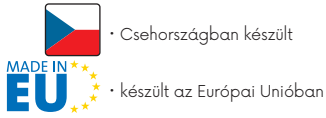

· ALKALMAZÁSI ELŐÍRÁSOK ·

- fa ·
- kerámia ·
- muanyag ·
- alumínium ·
- réz ·
- kő ·
- üveg ·
- komuves ·
- papír ·
- acél ·
- összetett ·
- csempe ·
- rozsdamentes acél ·
- vakolat ·
- fa csavarral, szögek ·
- gipszkarton ·
- anyagok fúrására ·
- ig húzószilárdságig ... ·

- S2** · acél S2
- HSS** · nagysebességu acélvágó
- Cr-Mo** · króm-molibdén acél
- CrV** · króm-vanádium acél
- INOX** · rozsdamentes acél
- NYLON** · nylon fogantyú
- TEFLON** · teflon felület
- Zn** · horganyzott felület
- TiN** · titán-nitrid bevonatú felület
- HRC 58-61** · HRC - anyag keménysége
- 40% PES** · az anyag százalékos összetétele - 40% poliészter
- PES** · 100% poliészter
- gyémánt felületi felület
- a termék vagy annak valamely része mágneses

- SDS+** · szerelési módszer
- SDS MAX** · szerelési módszer
- M14** · szerelési módszer
- 72T** · a fogak száma a racsos villás kulcsban
- 36T** · a fogak száma a racsos villás kulcsban
- 1/2"** · racsos
- 3/4"** · racsos
- 1/4"** · racsos
- 27 dB** · Információ a hangvédelemről
- DIN 3113** · alapértelmezett
- IP 54** · alapértelmezett
- 32x** · darabszám darabban
- II. class** · pontossági osztály
- III. class** · pontossági osztály
- hideg időre alkalmas
- ERGO HANDLE** · ergonomikus fogantyú
- HOBBY** · hobbi
- 2x AAA** · típusát és az akkumulátorok számát
- UV STABLE** · UV stabil
- RUBBER ENDS** · ütközésgátló gumi végek

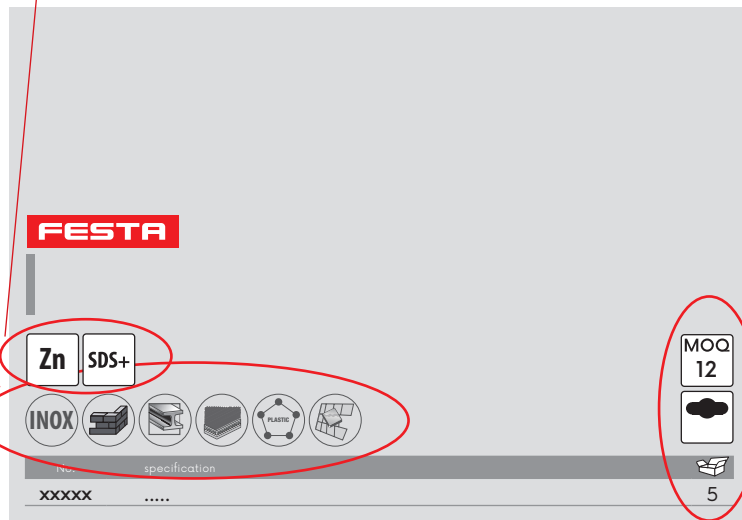

· CSOMAGOLÁSI INFORMÁCIÓK

- dobozba csomagolva
- euroslot
- MOQ 12** · Minimális rendelési mennyiség
- darabszám a csomagban

ALKALMAZOTT PIKTOGRAMOK LISTÁJA - FESTA AQUATIC, ROSA ·

- állítható permetezési minták ·

- minimális és maximális nyomás ·
- maximális vízáram ·
- öntözött terület ·
- adapter menete mérete ·
- tömlő átmérője ·

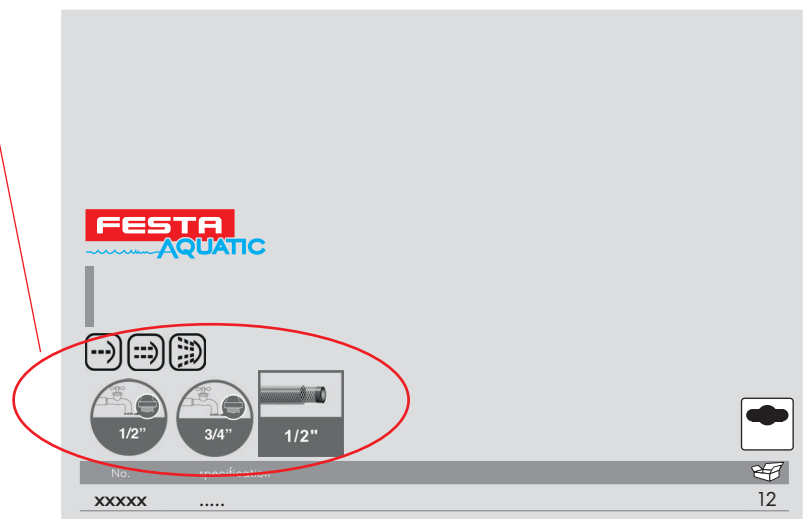

20

25

26



PROFI X SZERSZÁMOK



festatools



#festatools



festatools



www.festa.tools

HORIZONT.

FESTA
POWER X TOOLS

FESTA
AQUATIC

ROSA KOMELON.

KDS

Stahlberg

SUPER PRO

Lescha

