

FESTA

PROFESSIONAL  TOOLS



NEWS

2025

EXTREME CONDITIONS
EXTREME QUALITY

FESTA

MAIN PARTNER OF MARTIN MACÍK
AT THE DAKAR RACE

speed
520 min⁻¹

BPM / impact
0 - 4100 / 12 J

power
1500 W

clamping head
SDS MAX



MAX Ø concrete - Ø 40 mm



depth gauge

vibration reduction system

ergonomic rubberized handle for a comfortable and secure grip



dust collector

SDS MAX chuck

side handle



FESTA
POWER X TOOLS

HAMMER DRILL SDS MAX

The set contains:

- hammer drill
- side handle
- depth gauge
- wrench
- plastic case
- spare carbon brushes
- dust collector
- accessories SDS MAX:

Ø 16 x 280 mm
| 18 x 320 mm

spare carbons - 28229
2 pcs



No. Specifications

28221

2



FESTA
POWER X TOOLS



FESTO
POWER X TOOLS

DRYWALL SANDER

230V ~50Hz	750W	1000-1850min⁻¹	225mm	110-180 cm
LED	4m	DRYWALL		

01|2025

No.	Specifications	
28240		4



FESTO
POWER X TOOLS

HIGH-PRESSURE CLEANER

230 V ~50 Hz	1800 W	IPX5	MAX 7 l/min	MAX 140 bar	MAX 50°C	5m	AUTO STOP	7,8 kg
------------------------	---------------	-------------	--------------------	--------------------	-----------------	-----------	------------------	---------------

01|2025

No.	Specifications	
45271		1



FESTO
POWER X TOOLS

VACUUM CLEANER 30L

230 V ~50 Hz	1600 W	MAX 2000W	82dB	IPX4	3m	5m
30L	AUTO ON-OFF	AUTOMATIC FILTER CLEANING				

01|2025

No.	Specifications	
28345		1
28346	HEPA filtr	1

AUTOMATIC FILTER CLEANING



WEST BERG

VACUUM CLEANER 30L

230 V ~50 Hz	1200 W	3m	5m	SEMI-AUTOMATIC FILTER CLEANING
30L	WET DRY	AUTO ON-OFF		

No.	Specifications	
28340		1
28342	HEPA filtr	1



USB - C

FESTA
POWER X TOOLS

SUCTION CUP

Ø 220 mm	80 kg	110 kg	ROUGH SURFACE	USB-C	Li-ion 3.6V 2Ah
----------	-------	--------	---------------	-------	--------------------

No. Specifications

36326

01/2025

battery charge indicator

FESTA
POWER X TOOLS

BATTERY 20 V | 8,0 Ah

SHARE *Li-ion technology*

20V	8,0 Ah	Li-ion
-----	--------	--------

No. Specifications

28083

120 min

02/2025

FESTA
POWER X TOOLS

HOT MELT GLUE GUN

· Ø glue stick 7,2 mm

230V
~ 50Hz **12W**



No.	Specifications	
89775		1

WEST BERG

ELECTRIC MIXER

230V
50Hz **1600W** **2 SPEED**
180-400
300-700
rpm **2x**
Ø 140 mm **Zn** **M14** **5,4 kg**



spare carbons - 35315
2 pcs



No.	Specifications	
35305		1



WEST BERG

SOLDERING GUN KIT

230V
~ 50Hz **175W**



No.	Specifications	
28275		1
28278	tips 3pcs	1

WEST BERG

SOLDERING IRON

230V
~ 50Hz **60W**



No.	Specifications	
28280		1
28282	tips 2pcs	1

FESTA
INDUSTRY

EXTENSION CORD REEL

· rubber - IP44
· H07RN-F3G - 2,5mm²
· equipped with a thermal fuse
· 16 A max. / 3680 W max.



No.	specifications	
37740	4 socket length 25 m, IP 44, 2,5 mm ²	2
37741	4 socket length 50 m, IP 44, 2,5 mm ²	2

FESTA
INDUSTRY

EXTENSION CORD REEL

· rubber - IP44
· H05RR-F3G - 1,5mm²
· equipped with a thermal fuse
· 16 A max. / 3680 W max.



No.	specifications	
37750	4 socket length 25 m, IP 44, 1,5 mm ²	2
37751	4 socket length 50 m, IP 44, 1,5 mm ²	2

FESTA
INDUSTRY

EXTENSION CORD

· rubber - IP44
· H07RN-F3G - 1,5mm²
· 16 A max. / 3680 W max.



No.	specifications	
37744	length 5 m, 1,5 mm ²	8
37745	length 10 m, 1,5 mm ²	4
37746	length 20 m, 1,5 mm ²	8
37747	length 30 m, 1,5 mm ²	8

FESTA

EXTENSION CORD

· IP20
· H05VV-F3G - 1,5mm²
· 16 A max. / 3680 W max.



No.	specifications	
37732	length 30 m, 1,5 mm ²	8
37733	length 40 m, 1,5 mm ²	4

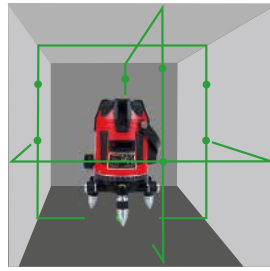
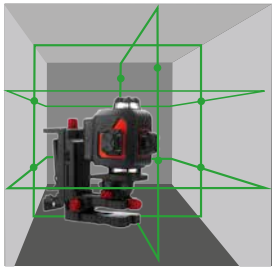

FESTA

LASER ALL LINE GREEN 4 x 360 °

- 2x horizontal plane + 2x vertical plane(green beam)
- self-levelling range $\pm 4^\circ$
- accuracy: 0,2 mm/m
- indoor: 30 m, outdoor with detector 50 m
- pulse mode – recommended accessory receiver 26209
- inclusive: carrying case, remote control, laser target, Li-ion battery 5200 mAh, professional bracket, mini tripod, charger

FESTA

LASER GREEN

- 1x horizontal plane + 4x vertical plane(green beam) + 1x dot
- self-levelling range $\pm 3^\circ$
- accuracy: 0,2 mm/m
- indoor: 20 m, outdoor with detector 50 m
- pulse mode – recommended accessory receiver 26209
- inclusive: carrying case, laser target, Li-ion battery 5200 mAh, professional bracket, mini tripod, charger

<td> <td></td> <td rowspan="2"></td> </td>	<td></td> <td rowspan="2"></td>					
<td> <td></td> <td></td> </td>	<td></td> <td></td>					
No. Specifications						1
26205						

<td> <td></td> <td rowspan="2"></td> </td>	<td></td> <td rowspan="2"></td>					
<td></td> <td></td> <td></td>						
No. Specifications						1
26203						

FESTA

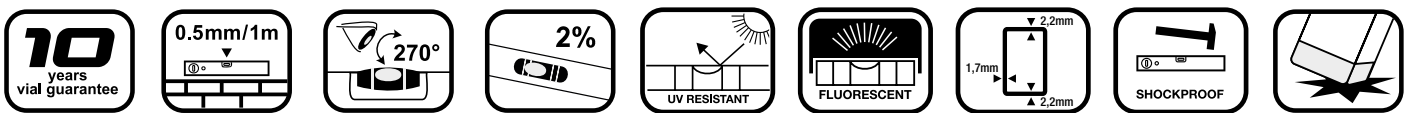

FESTA

LEVEL, 3 VIALS

No.	Specifications	
15754	400 mm	1
15756	600 mm	1
15758	800 mm	1
15760	1000 mm	1
15762	1200 mm	1
15768	1800 mm	1
15770	2000 mm	1



03|2025

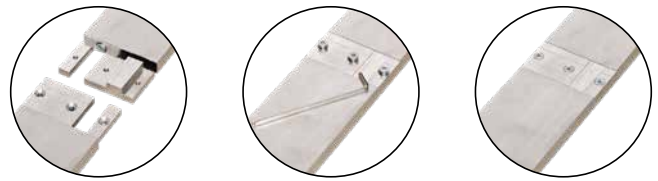

HORIZONT

CONNECTOR
FOR SCREED
LEVELS



No.	Specifications		
15301		1	



NIVELYS
LEVELING
SYSTEM

TILE LEVELING
PROFILE

ALU



NIVELYS
LEVELING
SYSTEM

ADJUSTABLE STAND
FOR LEVELING
PROFILE

max. 50 kg

2x

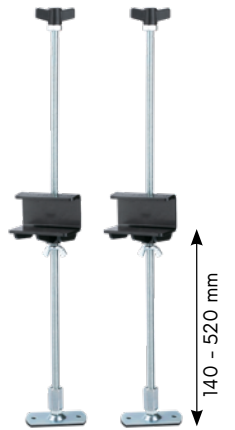

No.	Specifications		
37105	50 cm	1	
37106	100 cm	1	
37107	150 cm	1	

02|2025

No.	Specifications		
37102		1	

02|2025

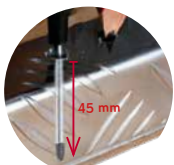

FESTA

AUTOMATIC PENCIL WITH CLIP HB

· spare pencils 13263, 13267

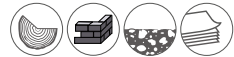

No.	specifications		
13288		20	

FESTA
INDUSTRY

PERMANENT MARKER

No.	Specifications		
13200		1	
13201		1	
13202		1	

02|2025

FESTA

CUTTER KNIFE
WITH SCRAPER

+2 SK4



No.	Specifications		
16039		1	
16087	spare blades	1	





FESTA
TINSMITH
PLIERS

No.	Specifications	
17341	24 mm	1



FESTA
TINSMITH
PLIERS 45°

No.	Specifications	
17342	24 mm 45°	1



FESTA
CUTTING FRONT
PLIERS

No.	Specifications	
17172	200 mm	1



FESTA
INDUSTRY
CRIMPING
PLIERS

No.	Specifications	
18445	6x	1



- AWG 22-18/16-14/12-10
- DIN 0,5-1,0/1,5-2,5/4-6mm²



- AWG 20-16/16-14/12-10/8
- DIN 0,5-1,0/1,5-2,5/4-6/10mm²



- AWG 20-18/16-14/12-10
- DIN 0,5-1,0/1,5-2,5/4-6mm²



- AWG 20/18/17/16/14/12
- DIN 0,5/0,75/1,0/1,5/2,5/4,0mm²



- AWG 10/8/6
- DIN 6/10/16mm²

03|2025



FESTA
INDUSTRY
MULTI-PURPOSE
CRIMPING PLIERS 5in1

No.	Specifications	
16206		1



- AWG 10-22
- 0,5-0,6mm²

- AWG 10-22
- 0,5-0,6mm²

- AWG 10-22
- 0,5-0,6mm²

- odizolování drátu
- AWG 10-24
- 0,2-0,6mm²

03|2025



FESTA
INDUSTRY
MULTI-PURPOSE
CRIMPING PLIERS 5in1

No.	Specifications	
16208		1

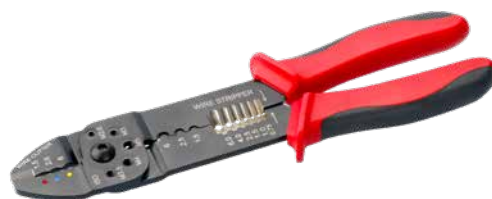

- 1,5; 2,5; 6,0mm²

- 1,5; 2,5; 6,0mm²

- wire stripper · 0,75; 1,0; 1,5; 2,5; 4,0; 6,0mm²

- screw cutting · M2,6; M3; M3,5; M4; M5

03|2025

FESTA**VOLTAGE TESTER**

· AC - 110 V, 250 V



No. Specifications

18427

1

FESTA**FESTA****ELECTRONICS
DIAGONAL PLIERS**· wire stripper - 0,75; 1,0; 1,5; 2,5; 4,0; 6,0mm²

No. Specifications

17087

145 mm

1

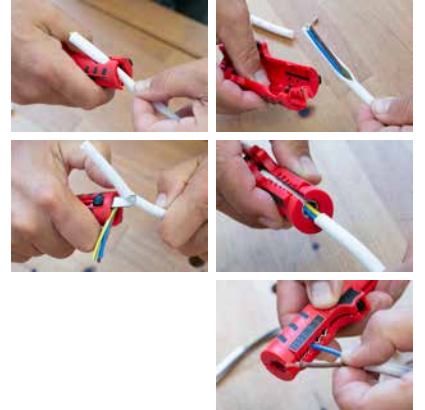
**FESTA****UNIVERSAL STRIPPING
TOOL**

· Ø 0,2-4 mm



No. Specifications

16205

125 mm

1

02|2025

**FESTA
INDUSTRY****SCREWDRIVER SET**

· screwdriver for bits

· screwdriver for precision bits

· screwdrivers 3x75, 5x75, 5x100, 6x100, 6x150, 8x150

0x75, 1x75, 1x100, 2x100, 2x150

T10x75, T15x75

VDE 2.5x75mm, 4.0x100mm

voltage tester

2.5x40, 3.0x40mm

00x40mm, 0x40mm,

T6x40mm, T7x40mm

· hex 1/16", 5/64", 3/32", 1/8", 5/32", 3/16", 7/32", 1/4"

1.5, 2.0, 2.5, 3.0, 4.0, 5.0, 5.5, 6.0mm

· socket heads 6mm, 7mm, 8mm, 9mm, 10mm, 11mm

· bits SL 3mm, 4mm, 4.5mm, 5mm, 5.5mm, 6mm, 7mm, 8mm

PH0, PH0, PH1, PH1, PH2, PH2, PH3, PH3

PZ0, PZ0, PZ1, PZ1, PZ2, PZ2, PZ3, PZ3,

T6, T8, T10, T15, T20, T25, T27, T30, T35, T40

H1.5, H2.5, H3.0, H3.5, H4.0, H4.5, H5.0, H5.5, H6, H8

S0, S1, S2, S3

· precision bits SL 1.5mm, 2.0mm, 2.5mm, 3.0mm, 4.0mm

PH000, PH00, PH0, PH1

T4, T5, T6, T7, T8, T9, T10, T15, T20

H0.7, H0.9

04|2025



114x S2

No. specifications

18434

1

**FESTA
INDUSTRY****IMPACT BIT SET**

PH 2 · 2

PZ 2

T 15 · 15 · 20 · 20 · 25 · 30 · 40



No. specifications

18432

1

FESTA**T HANDLE KEY SET
HEX + TORX**

H 2.5 · 3 · 4 · 5 · 6 · 8 · 10 mm

T 10 · 15 · 20 · 25 · 30 · 40 · 45



02|2025

No. Specifications

18501

1

FESTA
MAGNETIC BIT HOLDER



1/4" CrV

No.	Specifications	
18609	90mm	1

WEST BERG
ADAPTER BIT 1/4" - SDS +



1/4" → SDS+

No.	Specifications	
20742		1

FESTA
SCAFFOLDING WRENCH



12T CrV

No.	Specifications	
17452	19 x 22 mm	1

FESTA
RATCHET WRENCH SET



8-9-10-11-12-13-14-15-16-17-18-19 mm

CrV 72T

No.	Specifications	
17619		1

FESTA INDUSTRY
EXTENSION FOR QUICK GRIP CLAMPS

for FESTA INDUSTRY 23625, 23626, 23628, 23630



2x

No.	Specifications	
23635		6



FESTA
QUICK GRIP CLAMP FOR WORKBENCHES



max. 250 mm

No.	Specifications	
23595	250/ Ø 20 mm 60 kg	1

FESTA
QUICK GRIP CLAMP FOR WORKBENCHES



max. 120 mm

No.	Specifications	
23598	120/ Ø 20 mm 70 kg	1

FESTA
VARIABLE ANGLE STRAP CLAMP



No.	Specifications	
23637	4m x 25mm	1



FESTA

WHITE RUBBER MALLET

· fiberglass handle



No.	Specifications	
19281	680g	6



FESTA

CROWBAR



No.	Specifications	
19420	300 mm	1



FESTA

PIPE CUTTER

INOX ALU

ALU Cu PVC



No.	Specifications	
16307	Ø 28 mm	10



FESTA

PIPE CUTTER - SET

Ø 15 mm
Ø 22 mm
Ø 28 mm

3x INOX ALU

ALU Cu PVC



No.	Specifications	
16309		10



FESTA

PVC PIPE CUTTER

PLASTIC INOX

PVC



No.	Specifications	
16308	Ø 20 - 50 mm	10



FESTA

DEBURRING TOOL

ALU

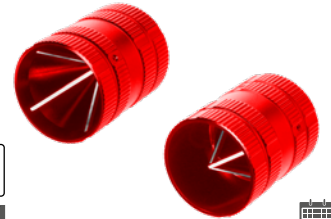

No.	Specifications	
16319	Ø 6 - 38 mm	1



FESTA

INDUSTRY

DIAMOND GRINDING CONE

M14

· Ø 2 mm - Ø 35 mm

· ceramic tiles and pavement
· marble
· granite

· no need to cool with water



No.	Specifications	
24775	Ø 2 - 35 mm	1



FESTA

INDUSTRY

DIAMOND HOLESAW

M14

· ceramic tiles and pavement
· marble
· granite

· no need to cool with water



No.	Specifications	
24642	Ø 72 mm M14	1



FESTA

INDUSTRY

DIAMOND GRINDING DRUM

M14

· ceramic tiles and pavement
· marble
· granite

· no need to cool with water



No.	Specifications	
24663	Ø 50 mm	1



FESTA

INDUSTRY

DIAMOND GRINDING DISC

M14

· ceramic tiles and pavement
· marble
· granite

· no need to cool with water

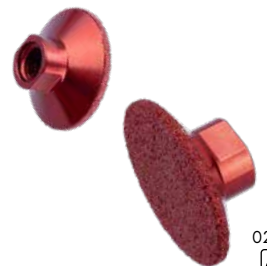

No.	Specifications	
24661	Ø 50 mm	1



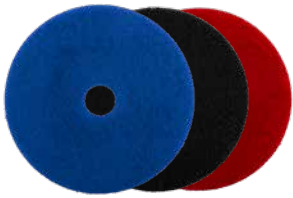

FESTA

DIAMOND GRINDING DISC



No.	specifications	hrubost	
24665	Ø 100 mm	● P60	10
24666	Ø 100 mm	● P120	10
24667	Ø 100 mm	● P200	10

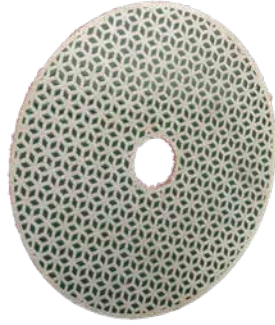

FESTA
INDUSTRY

DIAMOND GRINDING MULTI-PLATE DISC



- ceramic tiles and pavement
- marble
- granite
- no need to cool with water

No.	Specifications		
24647	Ø 115 mm Ø 22,2 mm	● P60	1
24648	Ø 115 mm Ø 22,2 mm	● P120	1
24649	Ø 115 mm Ø 22,2 mm	● P200	1

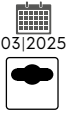
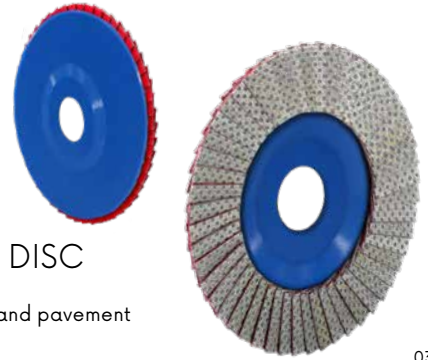

FESTA

RASP DISC



No.	Specifications	
21805	Ø 125 mm Ø 22,2 mm	10



FESTA
INDUSTRY

DIAMOND CUTTING DISC



- ceramic tiles and pavement
- marble
- granite
- no need to cool with water

No.	Specifications	
21234	Ø 115 mm x 1,2 x 8 mm Ø 22,2 mm	1
21238	Ø 200 mm x 1,6 x 11 mm Ø 25,4 mm	1



FESTA

MULTI-PLATE DOUBLE-SIDED DISC



No.	specifications	hrubost	
21760	Ø 125 mm Ø 22,2 mm	P40	10
21761	Ø 125 mm Ø 22,2 mm	P60	10
21762	Ø 125 mm Ø 22,2 mm	P80	10
21763	Ø 125 mm Ø 22,2 mm	P100	10
21764	Ø 125 mm Ø 22,2 mm	P120	10



CUTTING DISC FOR WOOD



No.	Specifications	
21809	Ø 125 mm x 4T Ø 22,2 mm	1

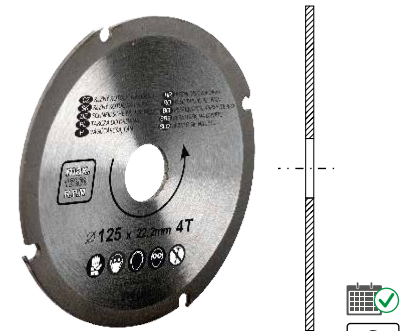

FESTA

KNOTTED WIRE BRUSH

No.	Specifications	
21950	Ø 200 mm 254 mm	1



BI-METAL HOLESAW

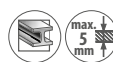

No.	Specifications	
24468	Ø 68 mm	5

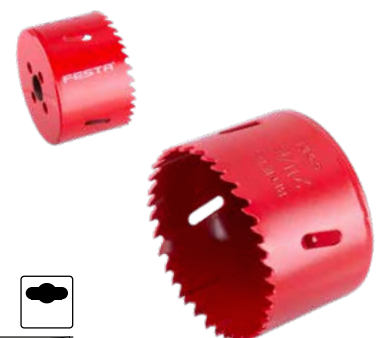



FESTA

JAPANESE SAW



No.	Specifications		
24114	260 mm	0,6 mm	10



FESTA

JAPANESE SAW



No.	Specifications		
24115	260 mm	0,6 mm	10



FESTA

FORSTNER DRILL BIT



No.	Specifications		
21531	Ø 15 mm	1	
21532	Ø 20 mm	1	
21533	Ø 25 mm	1	
21534	Ø 30 mm	1	
21535	Ø 35 mm	1	
21536	Ø 40 mm	1	



FESTA

FESTA

DRAWKNIFE



No.	Specifications		
24132	250/490 mm		1

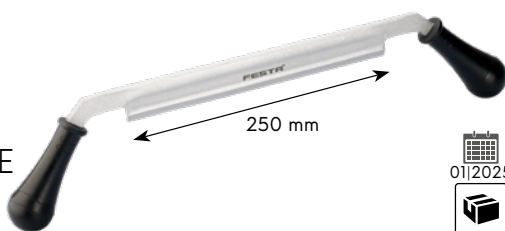

SANDING BLOCK

· Ø 150 mm

No.	Specifications		
22119			1





FESTA

FOLDING SAW HORSE 4in1

· max. load: 200 kg

No. Specifications

36410



FESTA

WORKBENCH FOLDABLE

· max. load: 450 kg

No. Specifications

23652

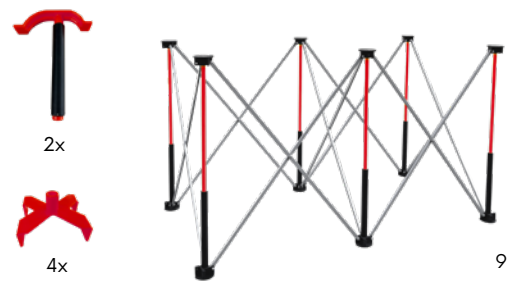

FESTA

CENTIPEDE PORTABLE WORKSTAND 3x2

· 1270 x 670 x 900 mm

· max. load: 1100 kg

No. Specifications

23661

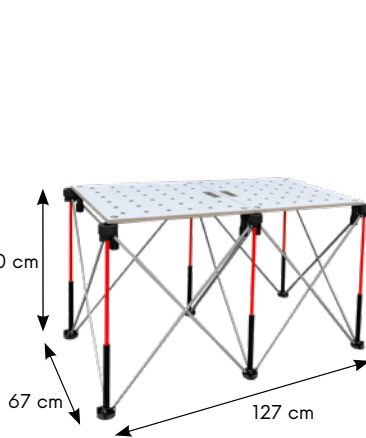
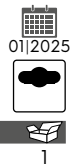

FESTA

CENTIPEDE WORKBENCH TABLE

· 1200 x 600 x 18 mm

No. Specifications

23664

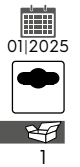

FESTA
INDUSTRY

LED WORK LAMP

3xLED

80,200, 300 lm

3W COB LED

USB TYPE C

Li-ion 3.7V

0.8Ah

120min

IK07

IP54

95g

0-180°

120min

No. Specifications

37647

3,7V 800 mAh





FESTA

MANUAL TILE CUTTER

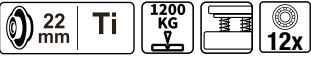

No.	Specifications	
36102	1050 mm	1
36103	1300 mm	1
36105	1550 mm	1

03|2025

FESTA

MULTIFUNCTION SCRAPER 9in1

INOX

No.	Specifications	
31519	75 mm	10



FESTA

SILICON SCRAPER 5in1

No.	Specifications	
37050		1

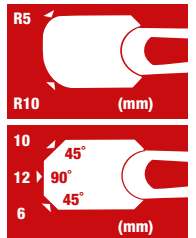

FESTA

ALUMINIUM CARTRIDGE

· pro 28060

No.	Specifications	
28061	600 ml	1



FESTA

CAULKING GUN

No.	Specifications	
38032	nylon	1



FESTA

MORTAR GROUT GUN

· 4x nozzle

No.	Specifications	
38045		1



FESTA

MIXER EXTENSION

No.	Specifications	
M14		
35142	M14	1

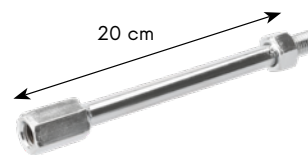



FESTA

FLAT CHISEL SDS +

SDS+



No.	Specifications	
20997	445 x 130 mm	1



FESTA

FLAT CHISEL SDS MAX

SDS MAX



No.	Specifications	
20932	450 x 100 mm	1

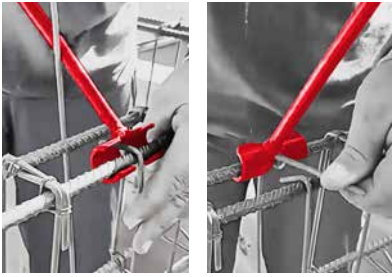

BAR BENDER

· Ø 4-8 mm



No.	Specifications	
26736		1

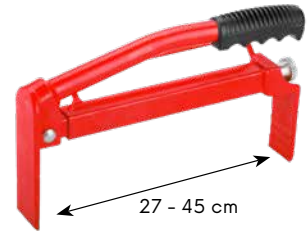

FESTA

BRICK CLAMP



No.	Specifications	
60130	27 - 45 cm	10

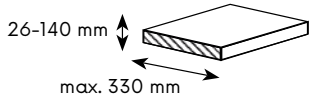

FESTA

BLOCK SPLITTER

· 43 kg



No.	Specifications	
60125		1



FESTA

PAVER PULLER



No.	Specifications	
60132		1

FESTA

PAVING SLAB TROLLEY

· max 100 kg



No.	Specifications	
60155		1

FESTA

PAVING CRUB TROLLEY

· max 150 kg



No.	Specifications	
60157		1

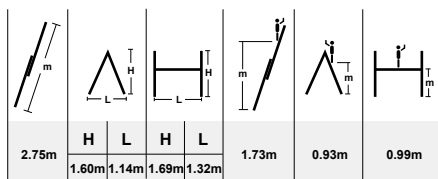

MULTIFUNCTION SCAFFOLD

13,6

max 150 kg

No. Specifications

37660



02|2025



FESTA

THREAD SEALING CORD

· 160m
· -20°C ... +130°C
· max 16 bar



01|2025

No. Specifications

38975



DRYWALL ACCESS MAGNETIC PANEL



No.	specifications	
82100	10 - 21 cm	1
82101	20 - 31 cm	1
82102	30 - 41 cm	1
82103	40 - 51 cm	1
82104	50 - 58 cm	1



COMPRESSOR AIR HOSE FITTINGS

8x



01|2025

No. Specifications

48013



ROSA

GARDEN HOSE CLEAR



No.	specifications	
45342	1/2" 10 m	1
45343	1/2" 15 m	1
45344	1/2" 20 m	1
45345	1/2" 25 m	1
45346	1/2" 50 m	1
45341	3/4" 10 m	1
45347	3/4" 15 m	1
45348	3/4" 20 m	1
45349	3/4" 25 m	1
45351	3/4" 50 m	1
45352	1" 15 m	1
45353	1" 25 m	1
45354	1" 50 m	1



FESTA AQUATIC

GARDEN HOSE PROFI



01|2025

No.	specifications	
45372	1/2" 25 m	1
45373	1/2" 50 m	1
45374	3/4" 25 m	1
45375	3/4" 50 m	1
45376	1" 25 m	1
45377	1" 50 m	1



2025

FESTA

PROFESSIONAL  TOOLS



festatools



#festatools



festatools



www.festa.tools

HORIZONT

FESTA
POWER X TOOLS

FESTA
AQUATIC

KDS KOMELON

ROSA

Stahlberg

Lescha SUPER PRO

