

# FESTA®

PROFI  SZERSZÁMOK

20

23

24



**FESTA**<sup>®</sup>

Minoségi márkájú kéziszerszámok muhely- és kertépítéshez

**HORIZONT**  
**EXACTA**

Csúcsminoségu vízszintmérók

**HORIZONT**

Csúcsminoségu vízszintmérók és léce

**FESTA**  
POWER X TOOLS

Akkumulátortermékek átfogó csoportja minőségi alkatrészekkel, a legújabb technológiákkal és az akkumulátoros szerszámok jelenlegi trendjeivel

**FESTA**  
**AQUATIC**

Profi öntözéstechnika választék, modern formák, rosa termékekkel kompatibilis

**ROSA**

Minoségi öntözorendszerek és kerti szerszámok

**KDS**<sup>®</sup>

Japán kések sokéves hagyománnyal

**KOMELON**<sup>®</sup>

Professzionális méróeszközök



Professzionális csempévágók



Minoségi kerti ollók gyártója

**Lescha**

Professzionális építőanyag keverök

**Stahlberg**

Professzionális csavarhúzó készletek



Professzionális furészmarkák

## AKKUS SZERSZÁMOK

2 - 23



4 10 11 12 13 13 14 15 15 18

## MÉROESZKÖZÖK

24 - 57



26 28 31 32 34 35 38 43 44 46 50 56

## SZERSZÁMOK

58 - 159



60 70 73 87 101 115 122 129 131 136 140 144 149 155

## VÁGÓ ÉS CSISZOLÓ ESZKÖZÖK

160 - 241



162 173 178 181 184 194 198 209 210 214 219 222 228 234

## KŐMŰVES SZERSZÁMOK

242 - 329



244 256 261 266 272 280 287 300 304 306 310 322 327 328

## KERTI SZERSZÁMOK ÉS KERÍTÉS

330 - 397



332 343 345 346 348 364 365 367 372 381 387 389 394 395

## VASÁRUK

398 - 431



400 404 406 409 411 412 413 415 417 418 420 426

## GARÁZSIPAR

432 - 443



434 435 436 438 439 440 440 441 441 442 443

## CIKKSZÁM RENDEZO

444 - 456

# FESTA

POWER X TOOLS

SHARE  
**20V**

*Li-ion*  
technology



AKKUMULÁTOROS  
SZERSZÁMOK

2 - 23



**BRUSHLESS****SHARE  
20V***Li-ion  
technology*

sebesség  
0-550 min<sup>-1</sup>  
0-2000 min<sup>-1</sup>

tömeg  
akkumulátorral 2,0 A **1,8 kg**  
akkumulátorral 4,0 Ah **2,1 kg**

nyomaték  
**80 Nm**

tokmány  
**2 – 13 mm**



A készlet tartalmaz:

- ütvefúró
- 2,0 Ah akkumulátor
- 4,0 Ah akkumulátor
- 2,4 A töltő
- kiegészítő fogantyú
- bőrönd

kiegészítő fogantyú

mód kiválasztása  
nyomaték erő választása



sebesség kapcsoló

gyors kioldás  
tokmány fej

forgásirány kapcsoló

ergonomikus gumírozott fogantyú  
a kényelmes és biztos fogásért

LED világítás

akkumulátor zár

horog akasztáshoz

**FESTA**  
POWER X TOOLS

AKKUS FÚRÓKALAPÁCS

R.s. leírás  
28000

2

## BRUSHLESS SHARE 20V Li-ion technology

sebesség  
0-550 min<sup>-1</sup>  
0-2000 min<sup>-1</sup>

tömeg  
akkumulátorral 2,0 Ah  
**1,8 kg**  
akkumulátorral 4,0 Ah  
**2,1 kg**

nyomaték  
**80 Nm**

tokmány  
**2 - 13 mm**

A készlet tartalmazza:  
- ütevfűró  
- 2,0 Ah akkumulátor  
- 2,4 A töltő  
- kiegészítő fogantyú  
- bőrönd



mód kiválasztása  
nyomaték erő választása

kiegészítő fogantyú

sebesség kapcsoló

gyors kioldás  
tokmány fej

forgásirány  
kapcsoló

ergonomikus gumírozott  
fogantyú a kényelmes  
és biztos fogásért

LED világítás

horog akasztáshoz

akkumulátor zár

**FESTA**  
POWER X TOOLS

### AKKUS FÚRÓKALAPÁCS



R.s.  
28001

leírás

2

## BRUSHLESS SHARE 20V

sebesség  
0-550 min<sup>-1</sup>  
0-2000 min<sup>-1</sup>

tömeg  
akkumulátor  
nélkül  
**1,4 kg**

nyomaték  
**80 Nm**

tokmány  
**2 - 13 mm**

#### Kiegészítők

28080 Akkumulátor 2,0 Ah

28081 Akkumulátor 4,0 Ah

28085 Töltő 2,4 A

28086 Töltő 4,0 A



mód kiválasztása  
nyomaték erő választása

kiegészítő fogantyú

sebesség kapcsoló

gyors kioldás  
tokmány fej

forgáskapcsoló

ergonomikus gumírozott  
fogantyú a kényelmes és  
biztos fogásért

LED világítás

horog akasztáshoz

**FESTA**  
POWER X TOOLS

### AKKUS FÚRÓKALAPÁCS



\*akkumulátor nem tartozék

R.s.  
28002

leírás

5

SHARE  
20VLi-ion  
technology

sebesség  
0-500 min<sup>-1</sup>  
0-1800 min<sup>-1</sup>

tömeg  
akkumulátorral  
2,0 Ah  
1,7 kg

nyomaték  
45 Nm

tokmány  
2 - 13 mm

A készlet tartalmaz:

- ütvefűró
- 2x 2.0 Ah Akkumulátor
- 2.4 A töltő
- bőrönd
- hordozó és bitek:
- ⊖ S5, S6 x 25 mm
- ⊕ PH1, PH2 x 25 mm
- ⊕ PZ1, PZ2 x 25 mm
- HSS fűrók  
2-2.5-3-4-5-6 mm

mód kiválasztása  
nyomaték erő választásagyors kioldás  
tokmány fejergonomikus gumírozott  
fogantyú a kényelmes és  
biztos fogásért

LED világítás

akkumulátor zár

sebesség kapcsoló

forgásirány

horog akasztáshoz

FESTA  
POWER X TOOLS

## AKKUS FÚRÓKALAPÁCS

R.s.  
28003

leírás

3

SHARE  
20V

sebesség  
0-550 min<sup>-1</sup>  
0-2000 min<sup>-1</sup>

tömeg  
akkumulátor  
nélkül  
1,4 kg

nyomaték  
80 Nm

tokmány  
2 - 13 mm

## Kiegészítők

28080 Akkumulátor 2,0 Ah  
28081 Akkumulátor 4,0 Ah28085 Töltő 2,4 A  
28086 Töltő 4,0 Amód kiválasztása  
nyomaték erő választásagyors kioldás  
tokmány fejergonomikus gumírozott  
fogantyú a kényelmes és  
biztos fogásért

LED világítás

sebesség kapcsoló

forgásirány

horog akasztáshoz

FESTA  
POWER X TOOLS

## AKKUS FÚRÓKALAPÁCS



\*akkumulátor nem tartozék

R.s.  
28004

leírás

5



## SHARE 20V *Li-ion technology*

sebesség  
0-350 min<sup>-1</sup>  
0-1300 min<sup>-1</sup>

tömeg  
akkumulátorral  
2,0 Ah  
1,3 kg

nyomaték  
28 Nm

tokmány  
1 – 10 mm

A készlet tartalmaz:

- ütvefúró
- 2x 2.0 Ah Akkumulátor
- 2.4 A töltő
- bőrönd
- hordozó és bitek:
- ⊖ S5, S6 x 25 mm
- ⊕ PH1, PH2 x 25 mm
- ✦ PZ1, PZ2 x 25 mm
- fúrók HSS
- 1,5-2,5-3-4-5-6 mm



mód kiválasztása  
nyomaték erő választása

gyors kioldás  
tokmány fej

sebesség kapcsoló

forgásirány  
kapcsoló

ergonomikus gumírozott  
fogantyú a kényelmes és  
biztos fogásért

LED világítás

akkumulátor zár

horog  
akasztáshoz



### FÚRÓ AKKUS CSAVARHÚZÓ



R.s.  
28005

leírás

3

## SHARE 20V

sebesség  
0-350 min<sup>-1</sup>  
0-1300 min<sup>-1</sup>

tömeg  
akkumulátor  
nélkül  
0,9 kg

nyomaték  
28 Nm

tokmány  
1 – 10 mm

### Kiegészítők

28080 Akkumulátor 2,0 Ah

28081 Akkumulátor 4,0 Ah

28085 Töltő 2,4 A

28086 Töltő 4,0 A



mód kiválasztása  
nyomaték erő választása

gyors kioldás  
tokmány fej

sebesség kapcsoló

forgásirány  
kapcsoló

ergonomikus gumírozott  
fogantyú a kényelmes és  
biztos fogásért

LED világítás

horog  
akasztáshoz



### FÚRÓ AKKUS CSAVARHÚZÓ



\*akkumulátor nem tartozék

R.s.  
28006

leírás

5

**Li-ion**  
technology

sebesség  
0-350 min<sup>-1</sup>  
0-1300 min<sup>-1</sup>

tömeg  
akkumulátorral  
1,5 Ah  
1 kg

nyomaték  
20 Nm

tokmány  
1 - 10 mm

A készlet tartalmaz:

- ütvefúró
- 2x Akkumulátor 12 V | 1.5 Ah
- töltő 12 V | 2.4 A
- bőrönd
- hordozó és bitek:
- ⊖ S5, S6 x 25 mm
- ⊕ PH1, PH2 x 25 mm
- ⊕ PZ1, PZ2 x 25 mm
- fúrók HSS  
1,5-2,5-3-4-5-6 mm



mód kiválasztása  
nyomaték erő választása

gyors kioldás  
tokmány fej

sebesség kapcsoló

LED világítás

akkumulátor töltésjelző

ergonomikus gumírozott fogantyú  
a kényelmes és biztos fogásért

forgásirány

akkumulátor



**FESTA**  
POWER X TOOLS

## FÚRÓ AKKUS CSAVARHÚZÓ



R.s. leírás

28007

5

**Li-ion**  
technology

sebesség  
teher nélkül  
200 min<sup>-1</sup>

tömeg  
akkumulátorral  
1,5 Ah  
0,4 kg

maximum nyomaték  
3 Nm

szorítófej  
1/4" hex

A készlet tartalmaz:

- csavarhúzó
- töltő 5 V | 0,5 A
- hordozó és bitek:
- ⊖ S5 x 50 mm
- ⊕ PH1 x 50 mm
- ⊕ PH2 x 50 mm
- H5 x 50 mm
- ⊕ T20 x 50 mm

1/4" gyorskioldó fej  
biztosítékkal

settings nyomaték

akkumulátor charge indicator

zár beállítása  
fogantyú helyzete

LED világítás

forgásirány kapcsoló

ergonomikus gumírozott  
fogantyú a kényelmes  
és biztos fogásért



LED világítás

**FESTA**  
POWER X TOOLS

## AKKUS CSAVARHÚZÓ



R.s. leírás

28008

10

**SHARE  
20V**

sebesség  
teher nélkül  
**0-2000 min<sup>-1</sup>**

tömeg  
akkumulátor  
nélkül  
**1,2 kg**

nyomaték  
**150 Nm**

szám  
az agyvérzések  
**0-3000 bpm**

1/4" gyorskioldó fej  
biztosítókkal



választható  
forgásirány

ergonomikus gumírozott  
fogantyú a kényelmes és  
biztos fogásért

LED világítás

horog akasztáshoz

**Kiegészítők**

28080 Akkumulátor 2,0 Ah  
28081 Akkumulátor 4,0 Ah



28085 Töltő 2,4 A  
28086 Töltő 4,0 A



**AKKUS ÜTVECSAVARÓZÓ**



\*akkumulátor nem tartozék

R.sz. leírás  
**28021**



**SHARE  
20V**

sebesség  
teher nélkül  
**I.0-300 min<sup>-1</sup>  
II.0-1000 min<sup>-1</sup>**

tömeg  
akkumulátor  
nélkül  
**1,7 kg**

találatok száma  
**0-5000 bpm**

fogantyú  
**SDS+**

mélységi stop

munkamód váltás  
(ütőhangszerrel / anélkül)

sebesség kapcsoló

irány  
a forgás  
kapcsoló

SDS rögzítés  
szerszámfej



**Kiegészítők**

28080 Akkumulátor 2,0 Ah  
28081 Akkumulátor 4,0 Ah



28085 Töltő 2,4 A  
28086 Töltő 4,0 A



**VEZETÉK NÉLKÜLI ÜTVEFÚRÓ**



\*akkumulátor nem tartozék

R.sz. leírás  
**28025**



**SHARE**  
**20V**

frekvencia lövés  
**60-100 min<sup>-1</sup>**

maximális hossza szögek / kapcsok  
**30 mm kemény anyagok**

maximális hossza szögek / kapcsok  
**50 mm puha anyagok**

tömeg akkumulátor nélkül  
**2,7 kg**



biztosíték

ergonomikus gumírozott fogantyú forrá kényelmes és biztos fogás

biztosíték működtető kapcsoló

horog akasztáshoz

LED hibajelzés

fényképezési mód kapcsoló

**Kiegészítők**

28080 Akkumulátor 2,0 Ah  
28081 Akkumulátor 4,0 Ah



28085 Töltő 2,4 A  
28086 Töltő 4,0 A



**Szögek**

23930 Szeg 30 mm, 2000 pcs  
23931 Szeg 40 mm, 2000 pcs  
23932 Szeg 50 mm, 2000 pcs

**Tűzőkapocs**

23935 Tűzőkapocs 30 mm, 2000 pcs  
23936 Tűzőkapocs 40 mm, 2000 pcs



LED világítás

üres tálca mutatója



biztosíték

ütőerő szabályozása

mozgatható magazin borítója

magazin borítózár

Megfelelő szög- és kapcs típusok:

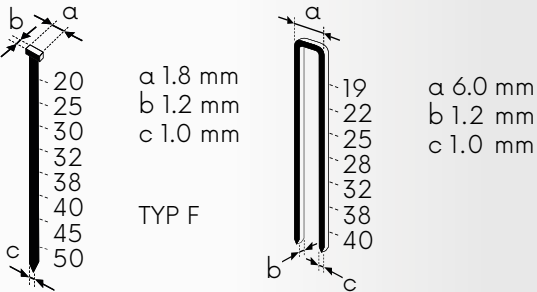

**AKKUS SZEGEZŐ ÉS TŰZŐGÉP**

max 60 min<sup>-1</sup>

a 1.8 mm  
 b 1.2 mm  
 c 1.0 mm  
 TYP F

a 6.0 mm  
 b 1.2 mm  
 c 1.0 mm

LED

2,7 kg

\*akkumulátor nem tartozék

**SHARE**  
**20V**

színhőmérséklet  
**6000 K**

tömeg  
akkumulátor nélkül  
**1,6 kg**

LED  
teljesítmény  
**30W**

fényáram  
**1800 lm (100%)**  
**1000 lm (60%)**  
**500 lm (30%)**



360° forgófej beállítás

karima a felszereléshez

a fényerősség beállítása  
30%, 60%, 100%



**Kiegészítők**

28080 Akkumulátor 2,0 Ah  
28081 Akkumulátor 4,0 Ah

28085 Töltő 2,4 A  
28086 Töltő 4,0 A



**LED LÁMPA AKU**



\*akkumulátor nem tartozék

R.sz. leírás  
**28065**



## BRUSHLESS SHARE 20V

sebesség  
teher nélkül  
**8500 min<sup>-1</sup>**

tömeg  
akkumulátor  
nélkül  
**1,6 kg**

maximális  
vastagság  
vágott anyag  
**15 mm**

maximális  
kerék átmérője  
**125 mm**

### Kiegészítők

28080 Akkumulátor 2,0 Ah

28081 Akkumulátor 4,0 Ah

28085 Töltő 2,4 A

28086 Töltő 4,0 A



motor szellőzőnyílásai

ergonomikus gumírozott  
fogantyú a kényelmes és  
biztos fogásért

forgászár

gyors kioldás  
gépezet  
védőborítás

biztosíték  
működtető  
kapcsoló



kerék rögzítő anyák



**FESTA**  
POWER X TOOLS

## AKKUMULÁTOROS SÁRKCSISZOLÓ



\*Az akkumulátor és a lemez nem tartozék

R.sz. 28030

leírás



4

## SHARE 20V

sebesség  
teher nélkül  
**8000 min<sup>-1</sup>**

tömeg  
akkumulátor  
nélkül  
**1,6 kg**

maximális  
vastagság  
vágott anyag  
**15 mm**

maximális  
kerék átmérője  
**115 mm**

### Kiegészítők

28080 Akkumulátor 2,0 Ah

28081 Akkumulátor 4,0 Ah

28085 Töltő 2,4 A

28086 Töltő 4,0 A



ergonomikus gumírozott  
fogantyú a kényelmes  
és biztos fogásért

forgászár

gyors kioldás  
gépezet  
védőborítás

biztosíték  
működtető  
kapcsoló



kerék rögzítő anyák



**FESTA**  
POWER X TOOLS

## AKKUMULÁTOROS SÁRKCSISZOLÓ



\*Az akkumulátor és a lemez nem tartozék

R.sz. 28032

leírás



4

**SHARE**  
**20V**

fordulat terhelés nélkül  
**10000 min<sup>-1</sup>**

tömeg akkumulátor nélkül  
**1 kg**

különcség kerek  
**5 mm**

átmérő kerek  
**125 mm**

működtető kapcsoló



**Kiegészítők**

- 28080 Akkumulátor 2,0 Ah
- 28081 Akkumulátor 4,0 Ah
- 28085 Töltő 2,4 A
- 28086 Töltő 4,0 A



AKKUMULÁTOR ORBITÁLIS CSISZOLÓGÉP



\*akkumulátor nem tartozék



R.s. leírás

28040



4

**SHARE**  
**20V**

fordulat terhelés nélkül  
**5000-15000 min<sup>-1</sup>**

tömeg akkumulátor nélkül  
**1 kg**

sebességszabályozás

szerszám rögzítő csap

cserekar és szerszámreteszeléssel

sebesség ellenőrzés

ergonomikus gumírozott fogantyú a kényelmes és biztos fogásért



**Kiegészítők**

- 28080 Akkumulátor 2,0 Ah
- 28081 Akkumulátor 4,0 Ah
- 28085 Töltő 2,4 A
- 28086 Töltő 4,0 A



VEZETÉK NÉLKÜLI KÉSZÜLÉK TÖBBFUNKCIÓS



\*akkumulátor nem tartozék



R.s. leírás

28045



4

SHARE  
20V



fordulat  
terhelés nélkül  
**3650 min<sup>-1</sup>**

állítható  
dőlésszög  
a vágásról  
**45-90 fok**

max. átmérő  
kerekek  
**165 mm**  
(ø16 mm)

maximális  
vágás  
50 mm  
\* 90 fokos szögben  
ø165 mm

### Kiegészítők

28080 Akkumulátor 2,0 Ah

28081 Akkumulátor 4,0 Ah

28085 Töltő 2,4 A

28086 Töltő 4,0 A



**FESTA**  
POWER X TOOLS

### AKKUMULÁTOROS KÖRFŰRÉSZ



\* akkumulátor nem tartozék

R.s. leírás  
28035 a fűrészlap a csomag része ø165x16 mm 24T





**SHARE**  
**20V**

a pengelöketek száma

**0-2400 min<sup>-1</sup>**

tömeg  
akkumulátor  
nélkül  
**1,8 kg**

max. szög  
ferde vágás  
**45 degrees**

max. cut  
profile

**acél: 6 mm**  
**faipari: 80 mm**

**Kiegészítők**

28080 Akkumulátor 2,0 Ah  
28081 Akkumulátor 4,0 Ah



28085 Töltő 2,4 A  
28086 Töltő 4,0 A



ergonomikus gumírozott fogantyú  
a kényelmes és biztos fogásért

biztosíték  
működtető kapcsoló

előszcilláció  
beállítás

LED

mancs  
lejtőreteszelés

rúdzár

bázis

vezetősín



**AKKUS DEKOPÍRFÜRÉS**



\*akkumulátor nem tartozék

R.sz. leírás

28050



4



ferde a vágást

0°  
45° 45°

**SHARE**  
**20V**

fordulat  
terhelés nélkül

**0-3000 min<sup>-1</sup>**

tömeg  
akkumulátor  
nélkül  
**1,7 kg**

max. vágási vastagság  
**Fa: 100 mm**  
**Acél: 5 mm**  
**alumínium / réz: 20 mm**

**Kiegészítők**

28080 Akkumulátor 2,0 Ah  
28081 Akkumulátor 4,0 Ah



28085 Töltő 2,4 A  
28086 Töltő 4,0 A



biztosíték  
működtető kapcsoló

ergonomikus gumírozott  
fogantyú a kényelmes és  
biztos fogásért

gyors kioldás  
fűrészlap



**AKKUS DUGATTYÚS FÜRÉS**



\*akkumulátor nem tartozék

R.sz. leírás

28055



4

SHARE  
20VLi-ion  
technology28004  
apród 628032  
apród 1228055  
apród 15KEDVEZMÉNYES  
+INGYENES TÁSKA  
ÁR28035  
apród 14

37330

28040  
apród 13FESTA  
POWER X TOOLS

## AKKUMULÁTOR SZETT TÁSKA KÉSZLETTEL 5+3



- 28004 - Akkus fúró kalapáccsal FESTA SHARE20V  
 28032 - Akkus sarokcsiszoló FESTA SHARE20V 115 mm  
 28035 - Körfűrész Akkus FESTA SHARE20V 165 mm/d 16 mm  
 28040 - Excentrikus köszörű Akkus FESTA SHARE20V 125 mm 8 otv.  
 28055 - Akkus fűrész FESTA SHARE20V  
 28080 - Akkumulátor akkumulátoros szerszámokhoz FESTA SHARE20V 2,0 Ah  
 28081 - Akkumulátor akkumulátoros szerszámokhoz FESTA SHARE20V 4,0 Ah  
 28086 - Töltő FESTA SHARE20V 4,0 A

28080  
apród 1828081  
apród 1828086  
apród 18

R.s. leírás

28101



1

SHARE  
20VLi-ion  
technology

BRUSHLESS

28002  
apród 528030  
apród 12KEDVEZMÉNYES  
+INGYENES TÁSKA  
ÁR28040  
apród 13

BRUSHLESS

37330

28055  
apród 1528035  
apród 14FESTA  
POWER X TOOLS

## AKKUMULÁTOR SZETT TÁSKA KÉSZLETTEL 5+3

- 28002 - Akkus fúró kalapáccsal FESTA SHARE20V  
 28030 - Sarokcsiszoló Akkus FESTA "BRUSHLESS" SHARE20V 125 mm  
 28035 - Körfűrész Akkus FESTA SHARE20V 165 mm/d 16 mm  
 28040 - Excentrikus köszörű Akkus FESTA SHARE20V 125 mm 8 otv.  
 28055 - Akkus fűrész FESTA SHARE20V  
 28080 - Akkumulátor akkumulátoros szerszámokhoz FESTA SHARE20V 2,0 Ah  
 28081 - Akkumulátor akkumulátoros szerszámokhoz FESTA SHARE20V 4,0 Ah  
 28086 - Töltő FESTA SHARE20V 4,0 A

28080  
apród 1828081  
apród 1828086  
apród 18

R.s. leírás

28104



1

**SHARE**  
**20V** *Li-ion*  
*technology*



28004  
apród 6

28025  
apród 9

37330

28030  
apród 12

**BRUSHLESS**

KEDVEZMÉNYES  
**ÁR**  
+INGYENES TÁSKA

**FESTA**  
POWER X TOOLS

## AKKUMULÁTOR SZETT TÁSKA KÉSZLETTEL 3+3

- 28004 - Akkus fúró kalapáccsal FESTA SHARE20V
- 28025 - Fúrókalapács Akkus FESTA SDS+ SHARE20V
- 28030 - Sarokcsiszoló Akkus FESTA "BRUSHLESS" SHARE20V 125 mm
- 28080 - Akkumulátor akkumulátoros szerszámokhoz FESTA SHARE20V 2,0 Ah
- 28081 - Akkumulátor akkumulátoros szerszámokhoz FESTA SHARE20V 4,0 Ah
- 28086 - Töltő FESTA SHARE20V 4,0 A

28080  
apród 18



28081  
apród 18



28086  
apród 18



R.s. leírás

28102



1

**BRUSHLESS** **SHARE**  
**20V** *Li-ion*  
*technology*



28002  
apród 5

37330

28030  
apród 12

KEDVEZMÉNYES  
**ÁR**  
+INGYENES TÁSKA

**FESTA**  
POWER X TOOLS

## AKKUMULÁTOR SZETT TÁSKA KÉSZLETTEL 2+3

- 28002 - Akkus fúró kalapáccsal FESTA SHARE20V
- 28030 - Sarokcsiszoló Akkus FESTA "BRUSHLESS" SHARE20V 125 mm
- 28080 - Akkumulátor akkumulátoros szerszámokhoz FESTA SHARE20V 2,0 Ah
- 28081 - Akkumulátor akkumulátoros szerszámokhoz FESTA SHARE20V 4,0 Ah
- 28086 - Töltő FESTA SHARE20V 4,0 A

28080  
apród 18



28081  
apród 18



28086  
apród 18



R.s. leírás

28103



1

## SHARE 20V



2,0 Ah



4,0 Ah

**FESTA**  
POWER X TOOLS

**TÖLTŐ 20 V | 24 A**

R.sz.	leírás
28085	220 – 240 V, 50 – 60 Hz, 70 W

20

## SHARE 20V



2,0 Ah



4,0 Ah

**FESTA**  
POWER X TOOLS

**TÖLTŐ 20 V | 4,0 A**

R.sz.	leírás
28086	*220 – 240 V, 50 – 60 Hz, 105 W

20

## SHARE 20V *Li-ion* technology



akkumulátor töltésjelző

**FESTA**  
POWER X TOOLS

**AKKUMULÁTOR 20 V | 2,0 Ah**

20V	2,0 Ah	Li-ion	0,4
-----	-----------	--------	-----



R.sz.	leírás
28080	

20

## SHARE 20V *Li-ion* technology



akkumulátor töltésjelző

**FESTA**  
POWER X TOOLS

**AKKUMULÁTOR 20 V | 4,0 Ah**

20V	4,0 Ah	Li-ion	0,7
-----	-----------	--------	-----



R.sz.	leírás
28081	

20

## BRUSHLESS

a szerszám árammal működik  
kefe nélküli DC motor

nyomaték



sebesség



választható irány  
a forgás



tokmány



fúrás, ütvefúrás,  
csavarozás



percenkénti löketség



fúrás, csavarozás



tömeg  
akkumulátorral / nélkül



rögzés módja



rögzés módja



rögzés módja



lemez excentricitása



a készülék vezérlése  
jobb és bal kézhez



megfelel ennek a szabványnak



fényáram



fény irányszöge



maximális tüzelési  
frekvencia



## SHARE 20V

az eszköz kompatibilis  
mindkét Akkumulátorral



megfelelő típusú körmök



megfelelő típusú csatok



csiszolókorong  
lyukakkal



maximális kerékátmérő



kerék átmérője



maximális vágási vastagság  
anyaga: fa



maximális vágási vastagság  
anyaga: acél



előoszillációs beállítás



fűrésrögzés



a pengelöketek száma



ferde lehetőség  
vágott



a fűrészlap gyors  
kioldása



a fűrészlengéseinek száma



LED világítás



akkumulátor-kapacitás



akkumulátor



töltési idő  
akkumulátor

MŰSZAKI  
MŰSZAKI ADATOK

TERMÉKKATALÓGUS SZÁM	28000	28001	28002	28003	28004
Név	Akkus fúrókalapács	Akkus fúrókalapács	Akkus fúrókalapács	Akkus fúrókalapács	Akkus fúrókalapács
Sebesség terhelés nélkül	I.0-550 min <sup>-1</sup> II.0-2000 min <sup>-1</sup>	I.0-550 min <sup>-1</sup> II.0-2000 min <sup>-1</sup>	I.0-550 min <sup>-1</sup> II.0-2000 min <sup>-1</sup>	I.0-500 min <sup>-1</sup> II.0-1800 min <sup>-1</sup>	I.0-500 min <sup>-1</sup> II.0-1800 min <sup>-1</sup>
Találatok száma	I.0-8800min <sup>-1</sup> II.0-32000min <sup>-1</sup>	I.0-8800min <sup>-1</sup> II.0-32000min <sup>-1</sup>	I.0-8800min <sup>-1</sup> II.0-32000min <sup>-1</sup>	0-19200 min <sup>-1</sup>	0-19200 min <sup>-1</sup>
Az ütések száma					
Nyomaték	80 Nm	80 Nm	80 Nm	45 Nm	45 Nm
Max. akkumulátor voltage	20V	20V	20V	20V	20V
Nyomaték szakaszok száma	20+1+1	20+1+1	20+1+1	19+1+1	19+1+1
Szorítófej	2-13 mm	2-13 mm	2-13 mm	2-13 mm	2-13 mm
Súly akkumulátor nélkül	1,4kg	1,4kg	1,4kg	1,3kg	1,3kg
Borító	IPX0	IPX0	IPX0	IPX0	IPX0
Hangnyomás szint bizonytalanság K	LpA=97,04dB(A) K=5dB(A)	LpA=97,04dB(A) K=5dB(A)	LpA=97,04dB(A) K=5dB(A)	LpA=79dB(A) K=5dB(A)	LpA=79dB(A) K=5dB(A)
Hangteljesítmény szint bizonytalanság K	LwA=86,04dB(A) K=5dB(A)	LwA=86,04dB(A) K=5dB(A)	LwA=86,04dB(A) K=5dB(A)	LwA=90dB(A) K=5dB(A)	LwA=90dB(A) K=5dB(A)
Rezgés kalapálás nélkül a fémbe	$\alpha_{h,D}=3,9m/s^2$ K=1,5m/s <sup>2</sup>	$\alpha_{h,D}=3,9m/s^2$ K=1,5m/s <sup>2</sup>	$\alpha_{h,D}=3,9m/s^2$ K=1,5m/s <sup>2</sup>	$\alpha_{h,D}=2,4m/s^2$ K=1,5m/s <sup>2</sup>	$\alpha_{h,D}=2,4m/s^2$ K=1,5m/s <sup>2</sup>
Rezgés kalapálás nélkül betonba	$\alpha_{h,D}=11,4m/s^2$ K=1,5m/s <sup>2</sup>	$\alpha_{h,D}=11,4m/s^2$ K=1,5m/s <sup>2</sup>	$\alpha_{h,D}=11,4m/s^2$ K=1,5m/s <sup>2</sup>	$\alpha_{h,D}=7,5m/s^2$ K=1,5m/s <sup>2</sup>	$\alpha_{h,D}=7,5m/s^2$ K=1,5m/s <sup>2</sup>
Maximális rezgés, bizonytalanság K					
Ütőerő					
Fúrás átmérője					
Rezgés a betonba - fő fogantyú					
Rezgés a betonban - kiegészítő fogantyú					
Csomag tartalma	fúró, 2,4 A töltő, akkumulátor 2.0 Ah, 4,0 Ah akkumulátor, kiegészítő fogantyú, bőrönd	fúró, töltő 2,4 A, akkumulátor 2.0 Ah, kiegészítő fogantyú, bőrönd	fúró	fúró, 2,4 A töltő, 2x 2,0 Ah akkumu- látor, 6x bit, hordozó, 6x fúró, bőrönd	fúró



28005	28006	28007	28008	28021	28025
Fúró akkus csavarhúzó	Fúró akkus csavarhúzó	Fúró akkus csavarhúzó	Akkus csavarhúzó	Akkus ütvecsavarozó	Vezeték nélküli ütvefúró
I.0-350 min <sup>-1</sup> II.0-1300 min <sup>-1</sup>	I.0-350 min <sup>-1</sup> II.0-1300 min <sup>-1</sup>	I.0-350 min <sup>-1</sup> II.0-1300 min <sup>-1</sup>	200 min <sup>-1</sup>	0-2000 min <sup>-1</sup>	I.0-300 min <sup>-1</sup> II.0-1000 min <sup>-1</sup>
					0-5000bpm
				0-3000bpm	
28 Nm	28 Nm	20 Nm	3 Nm	150 Nm	
20V	20V	12V	3.6V	20V	20V
19+1	19+1	19+1	6+1		
1-10mm	1-10mm	1-10mm	1/4" hexagon	1/4" hexagon	SDS+
0,9kg	0,9kg	*1kg	*0,4kg	1,2kg	1,7kg
IPX0	IPX0	IPX0	IPX0	IPX0	IPX0
LpA=69dB(A) K=5dB(A)	LpA=69dB(A) K=5dB(A)	LpA=78dB(A) K=5dB(A)	LpA=58dB(A) K=3dB(A)	LpA=92dB(A) K=3dB(A)	LpA=82,98dB(A) K=3dB(A)
LwA=80dB(A) K=5dB(A)	LwA=80dB(A) K=5dB(A)	LwA=67dB(A) K=5dB(A)	LwA=69dB(A) K=3dB(A)	LwA=103dB(A) K=3dB(A)	LwA=93,98dB(A) K=3dB(A)
$\alpha_{h,D} < 1,9m/s^2$ K=1,5m/s <sup>2</sup>	$\alpha_{h,D} < 1,9m/s^2$ K=1,5m/s <sup>2</sup>	$\alpha_{h,D} = 2,1m/s^2$ K=1,5m/s <sup>2</sup>			
$\alpha_{h,D} = 10,1m/s^2$ K=1,5m/s <sup>2</sup>	$\alpha_{h,D} = 10,1m/s^2$ K=1,5m/s <sup>2</sup>	$\alpha_{h,D} = 7,5m/s^2$ K=1,5m/s <sup>2</sup>			
			$\alpha_h < 2,5m/s^2$ K=1,5m/s <sup>2</sup>	$\alpha_{h,D} = 15,9m/s^2$ K=1,5m/s <sup>2</sup>	
					1,2J
					Acél: 10mm concrete: 20mm Faipari: 20mm
					$\alpha_{h,(HD)} = 5,582m/s^2$ K=1,5m/s <sup>2</sup>
					$\alpha_{h,(HD)} = 5,523m/s^2$ K=1,5m/s <sup>2</sup>
fúró, 2,4 A töltő, 2x 2,0 Ah akkumulátor, 6x bit, hordozó, 6x fúró, bőrönd	fúró	fúró, 2,4 A töltő, 2x 1,5 Ah Akkumulátor, 6x bit, hordozó, 6x fúró, bőrönd	csavarhúzó, töltő 0,5 A, 1,5 Ah akkumulátor, 5x bit	szorító	fúrókalapács, kiegészítő fogantyú, mélységi megálló

\* súly van feltüntetve akkumulátorral együtt

# MŰSZAKI MŰSZAKI ADATOK



TERMÉKKATALÓGUS SZÁM	28030	28032	28035	28040
Név	Vezeték nélküli szög őrlőgép	Akkus sarokcsiszoló	Vezeték nélküli kör alakú láttá	Akkumulátor orbitális csiszológép
Üresjárat sebesség	8500 min <sup>-1</sup>	8000 min <sup>-1</sup>	3650 min <sup>-1</sup>	10.000 min <sup>-1</sup>
Terhelés nélküli kilengések száma				
Előre				
Az előlengés fokok száma				
A fűrészlap pengéinek száma				
Maximális vágott profil				
Maximális kerékátmérő	125 mm	115 mm		
Támogató lemez				125 mm
A körön 8 szívás lyuk				65 mm
A kerék excentricitása				5 mm
Orsó menet mérete	M14	M14		
A vágott anyag maximális vastagsága	15 mm	15 mm		
Max. akkumulátor feszültség	20V	20V	20V	20V
Állítható vágási szög			0-45°	
Vágja 45°-os szögben			35 mm	
Vágja 90°-os szögben			50 mm	
Oscillációs szög				
A delta köszörülés mérete				
Vibrációs sebességszabályozás				
A fűrészlap felszerelése				
A fűrészlap lökete				
Alaplap mérete			28 cm x 13,3 cm	
Súly akkumulátor nélkül	1,6kg	1,6kg	2,7kg	1kg
Kerék átmérője			165 mm	
Keréktest vastagsága			1,4 mm ± 5% mm	
A penge SK vastagsága			2,0 ± 5% mm	
Vágási szélesség			2,3 ± 5% mm	
A kerékfurat átmérője befogás után			16 mm	
Korongfogak száma			24	
Borító	IPX0	IPX0	IPX0	IPX0
Szeg-típusú, magasság x szélesség x vastagság				
Csatok feszítávja x magasság x szélesség x vastagság				
Max. körmök hossza / csíptető puha szőnyegekbe.				
Max. szögek hossza / klipek kemény mattba.				
Átlagos / max. felvételi gyakoriság				
Üzemidő (4 AH akkumulátor, teljesen feltöltve)				
Szög / kapocstár kapacitása				
Hangnyomás szint bizonytalanság K	LpA=87,1dB(A) K=3dB(A)	LpA=76,67dB(A) K=3dB(A)	LpA=84dB(A) K=3dB(A)	LpA=76dB(A) K=3dB(A)
Hangteljesítmény szint bizonytalanság K	LwA=98,1dB(A) K=3dB(A)	LwA=87,67dB(A) K=3dB(A)	LwA=95dB(A) K=3dB(A)	LwA=87dB(A) K=3dB(A)
Rezgés a felület csiszolásakor	$\alpha_{h,AG}=8,363m/s^2$ K=1,5m/s <sup>2</sup>	$\alpha_{h,AG}=5,324m/s^2$ K=1,5m/s <sup>2</sup>		
Rezgés a deszka vágásához				
Vibráció lemezvágáshoz				
Vibráció a vágáshoz Fa:en keretek				
Maximális rezgés, bizonytalanság K			$\alpha_h < 2,5m/s^2$ K=1,5m/s <sup>2</sup>	$\alpha_h = 9,5m/s^2$ K=1,5m/s <sup>2</sup>
Csomag tartalma	köszörű, kerékburkolat, kiegészítő fogantyú, csavarkulcs	köszörű, kerékburkolat, kiegészítő fogantyú, csavarkulcs	láttá, mélységi stop, fűrészlap	őrlőgép, porgyűjtő zsák



28045	28050	28055	28070
Vezeték nélküli készülék többfunkciós	Akkus dekopírfűrész	Akkus dugattyús fűrész	Akkus szegező és tűzőgép
5000-15000 min <sup>-1</sup>		0-3000 min <sup>-1</sup>	
	3+0	1°	
	0-2400 min <sup>-1</sup>		
	Acél: 6mm, Faipari: 80mm	Faipari: 100 mm, Acél: 5 mm, alumínium/réz: 20 mm	
20V		20V	20V
	ferde vágás max. 45 °		
3°			
90 mm			
Igen			
egyetemes		egyetemes	
		20 mm	
1kg	1,8kg	1,7kg	2,7kg
IPX0	IPX0	IPX0	IPX0
			F, 20-50mm x 1,2mm x 1,0 mm
			6,0mm x 19-40mm x 1,2mm x 1,0mm
			50 mm
			30 mm
			60/100 min <sup>-1</sup>
			1 óra
			100 darabok
LpA=78dB(A) K=3dB(A)	LpA=88,1dB(A) K=5dB(A)	LpA=87,33dB(A) K=5dB(A)	LpA=79,9dB(A) K=3dB(A)
LwA=89dB(A) K=3dB(A)	LwA=99,1dB(A) K=5dB(A)	LwA=98,33dB(A) K=5dB(A)	LwA=90,9dB(A) K=3dB(A)
	$\alpha_{h,B}=3,3m/s^2$ $K=1,5m/s^2$ $\alpha_{h,M}=4m/s^2$ $K=1,5m/s^2$	$\alpha_{h,B}=21,10m/s^2$ $K=1,5m/s^2$	
		$\alpha_{h,WB}=21,98m/s^2$ $K=1,5m/s^2$	
$\alpha_h=2,8m/s^2$ $K=1,5m/s^2$			$\alpha_h=1,39m/s^2$ $K=1,5m/s^2$
daráló, tartozékok (fűrész, kaparó, hordozó), 3x csiszolópapír P80	latta, Führungsschiene, szívas kötődés, 2x fűrészlap	fűrész, 2x fűrészlap	szegező / tűzőgép, 200x szög, 200x kapocs



## MÉRŐESZKÖZÖK

24 - 57



26

MÉRŐSZALAGOK  
KOMELON

28

MÉRŐSZALAGOK FESTA



31

MÉRŐSZALAG



32

FAMÉRCE



34

TOLÓMÉRŐ



35

DERÉKSZÖG



38

EXACTA VÍZMÉRTÉK



43

VÍZMÉRTÉK NIVELA



45

NIVELA DIGITÁLIS



46

LASER



50

ÁCSZERUZA



56

JELŐLŐ SPRAY



· PONTOS MINŐSÍTETT MÉRÉSEK

# KOMELON®

- II. pontossági osztály a ČSN 251104, EEC 755345
- SZABVÁNYOK NAK MEGFELEL Tiszerte nagyobb kopásállóságú - új nylon DURA NY bevonatú felület.

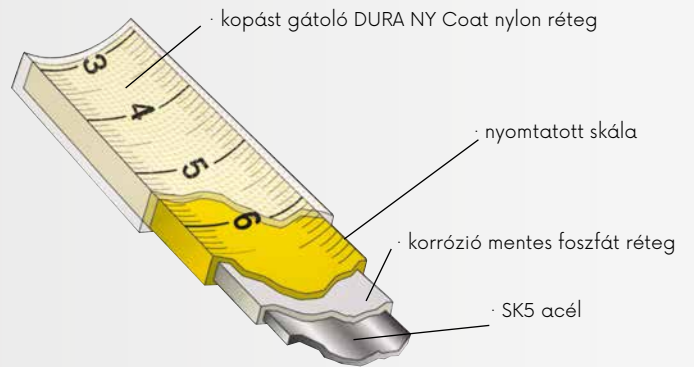

## KOMELON® MÉRŐSZALAGOK



· Nylon kopásálló bevonatok DURA NY Coat™



So.	leírás	
10002	2 m · 16 mm	10
10003	3 m · 16 mm	10
10005	5 m · 19 mm	10
10008	8 m · 25 mm	10

## KOMELON® MÉRŐSZALAGOK



· Nylon kopásálló bevonatok DURA NY Coat™



So.	leírás	
10025	5 m · 25 mm	10

## KOMELON® MÉRŐSZALAGOK

- automatikus fék
- csúszásgátló gumizálás



· Nylon kopásálló bevonatok DURA NY Coat™



So.	leírás	
10033	3 m · 16 mm	6
10035	5 m · 19 mm	6

## KOMELON® MÉRŐSZALAGOK



So.	leírás	
10043	3 m · 16 mm	30
10045	5 m · 19 mm	30
10048	8 m · 25 mm	12

**KOMELON®**

ACÉL MÉRŐSZALAG



So.	leírás	
10110	10 m · 10 mm	6
10120	20 m · 10 mm	6
10130	30 m · 10 mm	6

**KOMELON®**

ÜVEGSZÁLAS MÉRŐSZALAG



So.	leírás	
10330	10 m · 13 mm	6
10332	20 m · 13 mm	6
10334	30 m · 13 mm	6
10336	50 m · 13 mm	6

**KOMELON®**

ÜVEGSZÁLAS MÉRŐSZALAG



So.	leírás	
10430	30 m · 13 mm	1
10450	50 m · 13 mm	1
10490	100 m · 13 mm	1

**KOMELON®**

KOMELON ÁLLVÁNY

· Elemek standon 10996

10003	5 db
10005	4 db
10008	1 db
10033	2 db
10035	3 db
10045	2 db
10025	3 db
10110	1 db
10120	1 db
10130	1 db
10430	1 db
10330	1 db
10332	1 db
10334	1 db
10336	1 db



· illusztráció fotózás

So.	leírás	
10999	állvány	1
10996	állvány	1



· információ a mérőszalagról



- A** · mérőszalag hossza
- B** · pontossági osztály
- C** · megfelelőségi nyilatkozat - CE
- D** · gyártási év
- E** · A tanúsítványt kiállító akkreditált tanúsító szervezet száma
- F** · Gyártó
- G** · a szalag speciális beállítása
- H** · Hőmérséklet, amelyen a vizsgálatot végezték

KOMELON ÁLLVÁNY

So.	leírás	
10998		1



· illusztráció fotózás

**FESTA**



**FESTA**

**MÉRŐSZALAGOK**

- skálázás nagy számjegyekkel
- csúszásgátló gumizálás
- Nylon bevonatok



So.	leírás	
11353	3 m · 19 mm	12
11355	5 m · 19 mm	12
11356	5 m · 25 mm	12
11358	8 m · 25 mm	6
11360	10 m · 25 mm	6



**FESTA**

**MÉRŐSZALAGOK**



So.	leírás	
11343	3 m · 16 mm	6
11345	5 m · 19 mm	6
11347	7,5 m · 25 mm	6



**FESTA**

**MÉRŐSZALAGOK**

- 3x fék
- mágneses kampó
- bezár
- csúszásgátló gumizálás



So.	leírás	
11323	3 m · 16 mm	10
11325	5 m · 19 mm	10
11327	7,5 m · 25 mm	6



**FESTA**

**MÉRŐSZALAGOK**

- kis méretű mérőszalag
- Nylon bevonatok



So.	leírás	
11220	3 m · 16 mm	12
11221	5 m · 19 mm	12



**FESTA**

**MÉRŐSZALAGOK**

- skálázás nagy számjegyekkel



So.	leírás	
11226	2 m · 16 mm	10
11239	3 m · 19 mm	10
11259	5 m · 19 mm	10
11260	7,5 m · 25 mm	10

**FESTA**

MÉRŐSZALAGOK

- mágneses kampó
- csúszásgátló gumizálás
- fluoreszkáló szalag
- skálázás nagy számjegyekkel



So.	leírás	
11102	2 m · 16 mm	10
11103	3 m · 16 mm	10
11105	5 m · 19 mm	12
11106	5 m · 25 mm	12
11107	7,5 m · 25 mm	10
11110	10 m · 25 mm	6



**FESTA**

MÉRŐSZALAGOK

- automatikus fék
- csúszásgátló gumizálás



So.	leírás	
11333	3 m · 16 mm	12
11335	5 m · 19 mm	12
11337	7,5 m · 25 mm	12
11338	10 m · 25 mm	12



**Johnney**

MÉRŐSZALAGOK

- szalag matt kivitelezése



So.	leírás	
11002	2 m · 13 mm	12
11003	3 m · 13 mm	12
11005	5 m · 13 mm	12
11006	5 m · 19 mm	12
11007	7,5 m · 19 mm	12
11008	10 m · 25 mm	12



MÉRŐSZALAGOK

- bezár
- csúszásgátló gumizálás

So.	leírás	
11082	2 m · 16 mm	12
11083	3 m · 16 mm	12
11085	5 m · 19 mm	12



MÉRŐSZALAGOK

- metrikus és angol collos skálázás
- csúszásgátló gumizálás

So.	leírás	
11416	5 m · 19 mm	10

MÉRŐSZALAGOK

- bezár

So.	leírás	
11200	2 m · 13 mm	24
11201	2 m · 16 mm	24
11202	2 m · 19 mm	24
11204	3 m · 13 mm	24
11205	3 m · 16 mm	24
11206	3 m · 19 mm	24
11207	5 m · 19 mm	12
11208	5 m · 25 mm	12
11209	7,5 m · 25 mm	12
11210	10 m · 25 mm	12



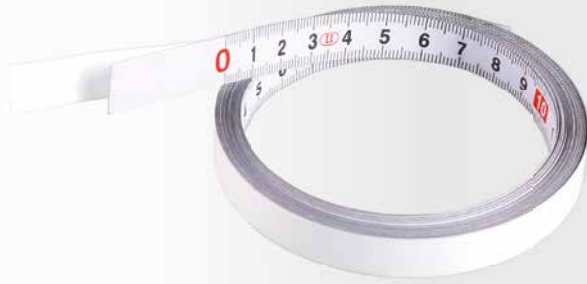

## ÖNTAPADÓ MÉRŐSZALAG

II. class



So.	leírás	
11311	1 m · 12,5 mm	30
11312	2 m · 12,5 mm	30
11313	3 m · 16 mm	30
11314	5 m · 19 mm	30

## MÉRŐSZALAG NÉVEL ELLÁTVA, 3M · 16 MM



II. class



So.	név	So.	név	So.	név
13500	JIRÍ	13512	MICHAL	13524	ROMAN
13501	PETR	13513	MILAN	13525	ŠIKULA
13502	JOSEF	13514	KAREL	13526	RADEK
13503	TOMÁŠ	13515	VLADIMÍR	13527	MISTR
13504	JAN	13516	DĚDEČEK	13528	ONDŘEJ
13505	MARTIN	13517	MŮJ METR	13529	MAREK
13506	JAROSLAV	13518	VÁCLAV	13530	STANISLAV
13507	FRANTIŠEK	13519	JAKUB	13531	BOREC
13508	PAVEL	13520	LUKÁŠ	13532	TATÍNEK
13509	MIROSLAV	13521	2X MĚŘ	13533	ANTONÍN
13510	BIG BOSS	13522	LADISLAV	13534	ALEŠ
13511	ZDENĚK	13523	DAVID		



FESTA

## MÉRŐSZALAG

- skálázás nagy számjegyekkel
- a klasszikus mérőszalag tulajdonságai

II. class

MOQ 12

So.	leírás	
11410	2 m · 16 mm 6 szín	12

## MÉRŐSZALAG

So.	leírás	
11420	1 m · 6 mm narancs	24



## MÉRŐSZALAG

## MÉRŐSZALAG

## KULCSTARTÓ LIBELLA

So.	leírás	
11444	1 m · 6 mm fehér	20

So.	leírás	
11425	1 m · 6 mm	25

So.	leírás	
11445		100





**FESTA**  
MÉRŐSZALAG

· hurok



So.	leírás	
12010	10 m · 10 mm	1
12020	20 m · 10 mm	1
12030	30 m · 10 mm	1
12050	50 m · 10 mm	6



**FESTA**  
ÜVEGSZÁLAS  
MÉRŐSZALAG

· hurok



So.	leírás	
12110	10 m · 13 mm	6
12120	20 m · 13 mm	1
12130	30 m · 13 mm	1
12150	50 m · 13 mm	1



**FESTA**  
MÉRŐSZALAG

· hurok + horog



So.	leírás	
12210	10 m · 10 mm	6
12220	20 m · 10 mm	6
12230	30 m · 10 mm	6
12250	50 m · 10 mm	6



**FESTA**  
ACÉL MÉRŐSZALAG NYÍTOTT

· hurok



So.	leírás	
12433	30 m · 12,5 mm	20
12435	50 m · 12,5 mm	10



**MÉRŐKERÉK**

- tartós, könnyű és kompakt
- a számláló előrehaladásnál hozzáad és visszalépésnél levon
- beépített világítás az éjszakai munkához, 2 db aaa elem a táskában



So.	leírás	
15989	max. 10 km	2



**FESTA**  
TELESZKÓPOS  
HOSSZMÉRŐ

· táskában

So.	leírás	
15983	0,7 - 3 m	10
15985	1,1 - 5 m	10
15988	1,6 - 8 m	5

## FAMÉRCE

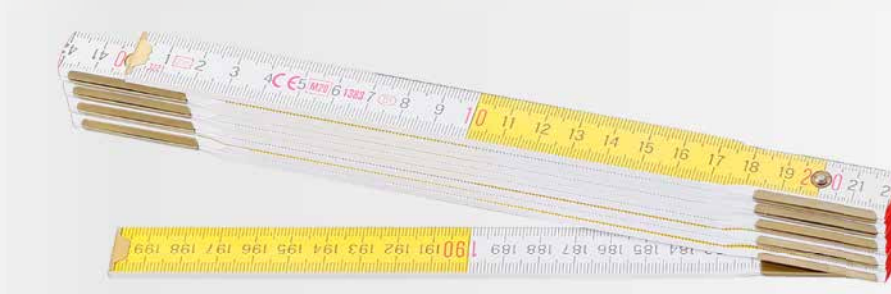

So.	leírás	
13010	1 m · fehér	20
13020	2 m · fehér	10
13021	1 m · sárga	20
13022	2 m · sárga	10
13023	2 m · fehér - sárga	10

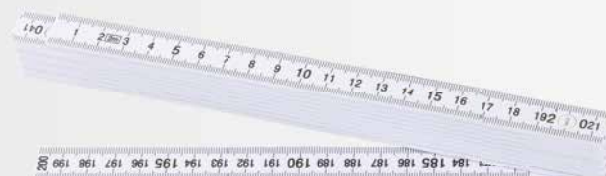

## FAMÉRCE



So.	leírás	
13111	1 m · sárga	10
13120	2 m · sárga	5

## FAMÉRCE



So.	leírás	
13210	1 m · mini	10
13211	1 m	1
13220	2 m	1



## FAMÉRCE NÉVEL ELLÁTVA



So.	név	So.	név	So.	név	
13401	JIŘÍ	13426	DANIEL			10
13402	JAN	13427	ANTONÍN	13451	JANA	
13403	PETR	13428	VOJTĚCH	13452	EVA	
13404	JOSEF	13429	FILIP	13453	PETRA	
13405	PAVEL	13430	ADAM	13454	MAJKA	
13406	MARTIN	13431	MILOSLAV	13455	HANA	
13407	JAROSLAV	13432	MATĚJ	13456	ANNA	
13408	TOMÁŠ	13433	ALEŠ	13457	LENKA	
13409	MIROSLAV	13434	JAROMÍR	13458	KATKA	
13410	ZDENĚK	13435	LIBOR	13459	LUCIE	
13411	FRANTIŠEK	13436	DOMINIK	13460	ALENA	
13412	VÁCLAV	13437	PATRIK	13461	VERONIKA	
13413	MICHAL	13438	VLASTIMIL	13462	MARTINA	
13414	MILAN	13439	JINDŘICH	13463	JITKA	
13415	KAREL	13440	MILOŠ	13464	BIG BOSS	
13416	JAKUB	13441	JÁN	13465	2 x MĚŘ	
13417	DAVID	13442	PETER	13466	TATÍNEK	
13418	LUKÁŠ	13443	ONDREJ	13467	DĚDEČEK	
13419	VLADIMÍR	13444	JOZEF	13468	ŠIKULA	
13420	LADISLAV	13445	PAVOL	13469	MISTR	
13421	ONDŘEJ	13446	L'UBOMÍR	13470	MACHR	
13422	ROMAN	13447	KAROL	13471	BOREC	
13423	STANISLAV	13448	RADOSLAV	13472	UŽ JE MŮJ	
13424	MAREK	13449	VOJTĚCH	13473	MŮJ METR	
13425	RADEK	13450	ZDENKO			

FAMÉRCE ÁLLVÁNY

· Elemek a Standben 13399

- 13401 · 15 db
- 13402 · 15 db
- 13403 · 15 db
- 13404 · 15 db
- 13405 · 15 db
- 13406 · 15 db
- 13412 · 15 db
- 13413 · 15 db
- 13414 · 15 db
- 13415 · 15 db
- 13416 · 15 db
- 13417 · 15 db
- 13418 · 15 db
- 13419 · 15 db
- 13420 · 15 db
- 13421 · 10 db
- 13422 · 10 db
- 13423 · 10 db
- 13424 · 10 db
- 13425 · 10 db
- 13426 · 10 db
- 13427 · 10 db
- 13428 · 10 db
- 13429 · 10 db
- 13430 · 10 db
- 13431 · 10 db
- 13432 · 10 db
- 13433 · 10 db
- 13434 · 10 db
- 13435 · 10 db
- 13436 · 10 db
- 13437 · 10 db
- 13438 · 10 db
- 13439 · 10 db
- 13440 · 10 db



So.	leírás	
13399	Famércével töltött állvány	1
13400	Állvány nélkül	1

**FESTA**

VONALZÓ FOGANTYÚVAL

**ALU**



· 2 x libellás | fiola

So.	leírás
14030	600 mm



6

**FESTA**

ALU VONALZÓ

**ALU**



So.	leírás
14015	400 mm
14017	600 mm
14019	1000 mm



48

50

40

**FESTA**

ACÉL VONALZÓ

**INOX**

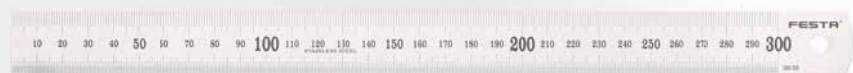

So.	leírás
14010	300 mm
14011	600 mm
14012	1000 mm



10

20

20

**FESTA**

## DIGITÁLIS TOLÓMÉRŐ

INOX



So.	leírás	
14007	150   0,01 mm	10
14008	200   0,01 mm	10
14009	300   0,01 mm	10



## DIGITÁLIS TOLÓMÉRŐ

· pontosság 0,2 mm, resolution 0,1 mm

So.	leírás	
14013	150   0,2 mm	10

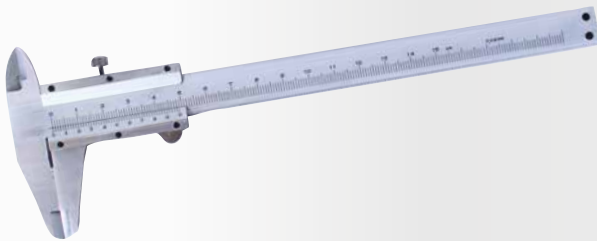
**FESTA**

## TOLÓMÉRŐ

INOX

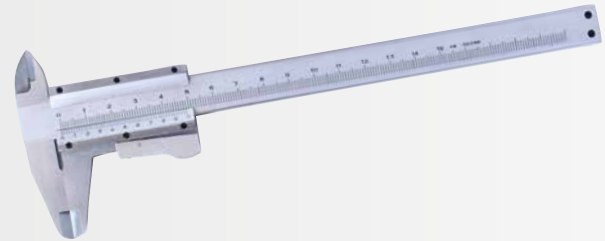

So.	leírás	
14001	150   0,02 mm	10
14002	200   0,02 mm	10
14003	300   0,02 mm	10

**FESTA**

## TOLÓMÉRŐ

INOX



So.	leírás	
14004	150   0,02 mm	10

**FESTA**

## MIKROMÉTER

So.	leírás	
14040	0 - 0,25   0,01 mm	10
14045	25 - 50   0,01 mm	10



## TOLÓMÉRŐ

HOBBY



So.	leírás	
14006	150 mm	50

**FESTA**

## INDIKÁTOR ÓRA

INOX



So.	leírás	
14035	0 - 10mm   0,01 mm	10



## HÉZAG MÉRŐ

· 20 lap

So.	leírás	
14080	0,05 - 1 mm	10



**FESTA**

**SZÖGMÉRŐ FORGÓ KARRAL**

· táska

**INOX**

So.	leírás	
14060	0° - 180° · 150 x 200 mm	5
14070	0° - 180° · 300 x 500 mm	7



**SZÖGMÉRŐ**

**HOBBY**

So.	leírás	
14075	0° - 180° · 230 x 500 mm	30

**NEW**



**TÖBBCÉLÚ VONALZÓ**

No.	Specification	
14077		1



**TÖBBCÉLÚ VONALZÓ**

**PLASTIC**

So.	leírás	
14480	250 x 120 mm	1



**KONTURMÁSOLÓ**

**PLASTIC**

So.	leírás	
14090	125 x 30 mm	1
14091	250 x 30 mm	1





**FESTA**  
DERÉKSZÖG

ALU



So.	leírás	
14420	180 mm	10
14421	300 mm	10

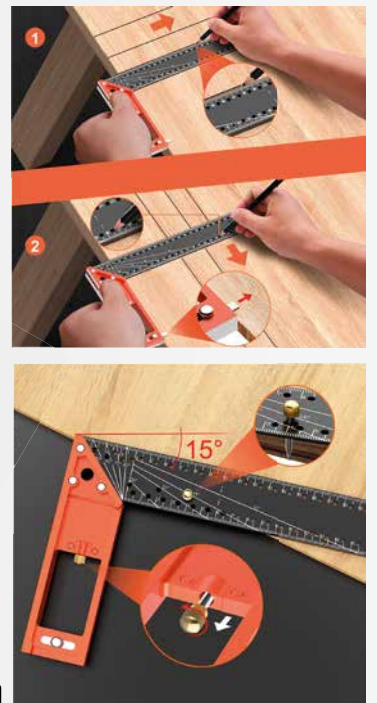
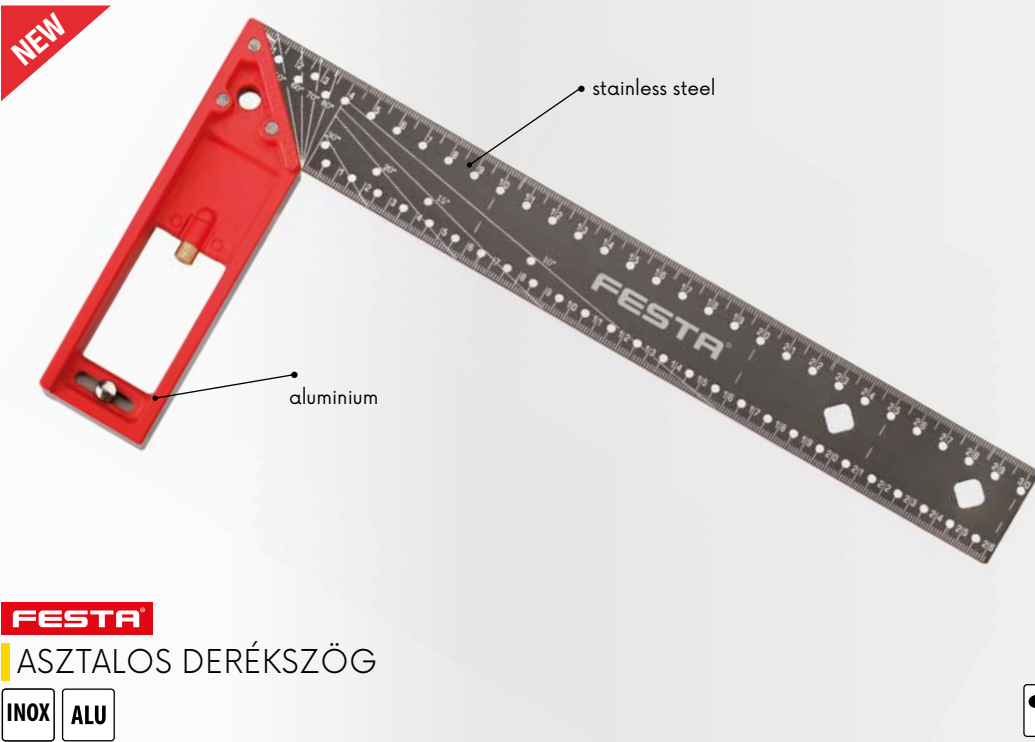

**FESTA**  
ASZTALOS DERÉKSZÖG

INOX ALU



No.	Specification	
14415	300 mm	6
14417	400 mm	6

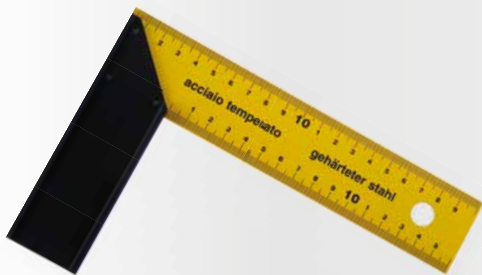

**FESTA**  
ASZTALOS DERÉKSZÖG



So.	leírás	
14220	200 x 125 mm	10
14225	250 x 135 mm	10
14230	300 x 135 mm	10



**FESTA**  
ÁCS DERÉKSZÖG



So.	leírás	
14350	500 x 235 mm	10
14360	600 x 300 mm	10
14370	700 x 300 mm	10

So.	leírás	
14380	800 x 320 mm	10
14399	1000 x 360 mm	10



**FESTA**  
DERÉKSZÖG

ALU



So.	leírás	
14450	190 x 355 mm	6
14451	200 x 405 mm	6



**FESTA**  
DERÉKSZÖG

ALU

So.	leírás	
14445	600 x 600 mm	1
14446	1200 x 1200 mm	1



DERÉKSZÖG

So.	leírás	
14410	300 x 200 mm	50
14411	600 x 400 mm	36

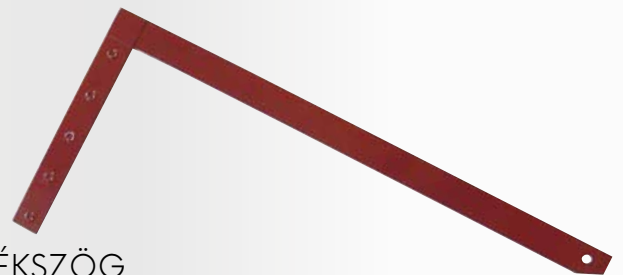

DERÉKSZÖG

So.	leírás	
14455	300 x 200 mm	50
14456	500 x 250 mm	50
14457	700 x 300 mm	40
14458	1000 x 450 mm	30



LAKATOS DERÉKSZÖG FELÜLETKEZELT

Zn

So.	leírás	
14471	150 x 100 mm	25
14472	250 x 125 mm	25
14473	400 x 200 mm	30
14474	600 x 300 mm	25



TALPAS DERÉKSZÖG FELÜLETKEZELT

Zn

So.	leírás	
14490	100 x 50 mm	10
14491	150 x 75 mm	10
14492	250 x 125 mm	10
14493	400 x 200 mm	10
14494	600 x 300 mm	10



DERÉKSZÖG

ALU

HOBBY

So.	leírás	
14425	250 x 130 mm	12
14430	300 x 130 mm	12
14435	350 x 156 mm	12
14440	400 x 156 mm	12

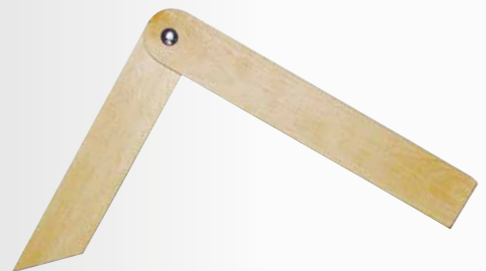

SZÖGMÁSOLÓ

MADE IN EU



So.	leírás	
14025	255 x 285 mm	1

# HORIZONT<sup>®</sup> EXACTA

Precíz vízmértékek a legmagasabb pontossággal

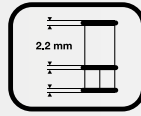
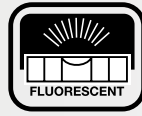
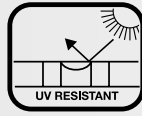
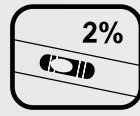
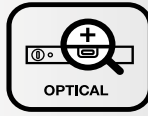
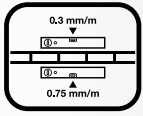

Minden termék elektromossan tesztelt, nyilvántartási számmal ellátott ISO 90001 tanúsítással rendelkező gyártó



## HORIZONT<sup>®</sup>

### EXACTA VÍZMÉRTÉK 2 LIBELLÁS

ALU

So.	leírás	
15033	60 cm	10



## HORIZONT<sup>®</sup>

### EXACTA VÍZMÉRTÉK 3 LIBELLÁS

ALU

So.	leírás	
15034	80 cm	10
15035	100 cm	10



## HORIZONT<sup>®</sup>

### EXACTA VÍZMÉRTÉK 3 LIBELLÁS, 2 FOGANTYÚS

ALU

So.	leírás	
15036	120 cm	10
15037	150 cm	10
15039	200 cm	10



# HORIZONT®

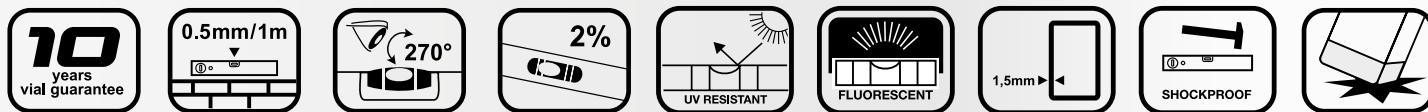

Minden termék elektromosan tesztelt, nyilvántartási számmal ellátott ISO 90001 tanúsítással rendelkező gyártó



## HORIZONT®

### VÍZMÉRTÉK 2 LIBELLÁS



So.	leírás	
15003	30 cm	30
15004	40 cm	30
15005	50 cm	30
15006	60 cm	30
15008	80 cm	30
15010	100 cm	30
15012	120 cm	10
15015	150 cm	10
15018	180 cm	10
15020	200 cm	10



## HORIZONT®

### VÍZMÉRTÉK 3 LIBELLÁS



So.	leírás	
15103	30 cm	30
15104	40 cm	30
15105	50 cm	30
15106	60 cm	30
15108	80 cm	30
15110	100 cm	30
15112	120 cm	10
15115	150 cm	10
15118	180 cm	10
15120	200 cm	10

**HORIZONT.**

## VÍZMÉRTÉK 2 LIBELLÁS+MÁGNES

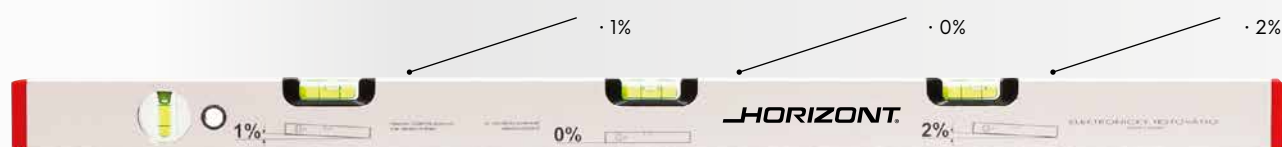

So.	leírás	
15204	40 cm	30
15205	50 cm	30
15206	60 cm	30
15208	80 cm	30
15210	100 cm	30
15212	120 cm	10
15215	150 cm	10
15218	180 cm	10
15220	200 cm	10

**HORIZONT.**

## LEJTŐ VÍZMÉRTÉK 4 LIBELLÁS

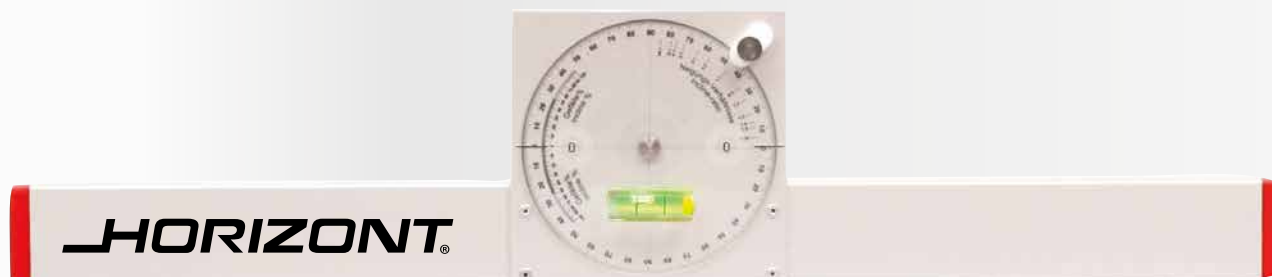

So.	leírás	
15230	80 cm	10

**HORIZONT.**

## SZÖGMÉRŐS VÍZMÉRTÉK



So.	leírás	
15235	60 cm	1

**HORIZONT.**

## ÖLESLÉC



So.	leírás	
15310	100 cm	10
15315	150 cm	10
15318	180 cm	10
15320	200 cm	10
15325	250 cm	10
15330	300 cm	10
15335	350 cm	10
15340	400 cm	10



**HORIZONT.**

**HORIZONT.**  
**ÖLESLÉC 1 LIBELLÁS**

ALU

So.	leírás	
15415	150 cm	10
15418	180 cm	10
15420	200 cm	10
15425	250 cm	10
15430	300 cm	10



**HORIZONT.**

**HORIZONT.**  
**ÖLESLÉC 2 LIBELLÁS**

ALU

So.	leírás	
15510	100 cm	10
15515	150 cm	10
15518	180 cm	10
15520	200 cm	10
15525	250 cm	10
15530	300 cm	10
15535	350 cm	10
15540	400 cm	5



**HORIZONT.**

**HORIZONT.**  
**ÖLESLÉC 2 FOGANTYÚS**

ALU

So.	leírás	
15615	150 cm	10
15620	200 cm	10
15625	250 cm	10
15630	300 cm	10



**HORIZONT.**

**HORIZONT.**  
**ÖLESLÉC 2 LIBELLÁS**

ALU

So.	leírás	
15710	100 cm	10
15715	150 cm	10
15720	200 cm	10
15725	250 cm	10
15730	300 cm	10
15735	350 cm	10
15740	400 cm	5

NEW

## HORIZONT. DERÉKSZÖG

ALU



So.	leírás	
14485	800 x 1200 mm	1
14486	1000 x 1500 mm	1



## HORIZONT. LEHÚZÓLÉC, TRAPÉZ ALAKÚ

TRAPÉZ ALAKÚ PROFI

- A trapéz alakú profil finomabb felületkezeléshez használandó
- Stukkókra és homlokzatra alkalmas
- Vékonyrétegű vakolatokhoz alkalmas

ALU

So.	leírás	
15810	100 cm	10
15812	120 cm	10
15815	150 cm	10
15818	180 cm	10
15820	200 cm	10
15825	250 cm	10
15830	300 cm	10



## HORIZONT. LEHÚZÓLÉC, H ALAKÚ

"h" profil

- "H" profil finomabb felületkezelésre szolgál
- Stukkókra és homlokzatokra alkalmas
- Stukkó mennyezetre alkalmas

ALU

So.	leírás	
15850	100 cm	10
15853	150 cm	10
15855	180 cm	10
15860	200 cm	10
15870	250 cm	10
15880	300 cm	10

## HORIZONT. HORIZONT BEMUTATÓ ÁLLVÁNY

· elemek a standben 15998

15003	· 5 db
15004	· 5 db
15005	· 5 db
15006	· 5 db
15008	· 5 db
15010	· 5 db
15012	· 5 db
15015	· 3 db
15018	· 3 db
15020	· 3 db
15108	· 3 db
15206	· 3 db
15210	· 3 db

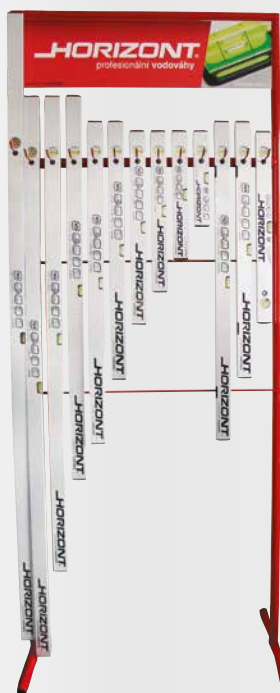

## HORIZONT. HORIZONT BEMUTATÓ ÁLLVÁNY

· elemek a standben 15996

15004	· 5 db
15005	· 5 db
15006	· 5 db
15008	· 5 db
15010	· 5 db
15012	· 5 db
15015	· 5 db
15018	· 5 db
15020	· 5 db
15315	· 2 db
15320	· 2 db
15325	· 3 db
15515	· 2 db
15520	· 2 db
15525	· 3 db



So.	leírás	
15999	85 x 210 x 50 cm	1
15998	85 x 210 x 50 cm feltöltött állvány	1

So.	leírás	
15997	55 x 75 x 40 cm	1
15996	55 x 75 x 40 cm feltöltött állvány	1

- Pontosság 0,5 mm | 1 m
- UV stabil folyadékok a vízszintmérőbe
- ütésálló gumi végződés
- bevonat vastagsága 1,2m



## NIVELA

### VÍZMÉRTÉK NIVELA

· gumi végek



So.	leírás	
15904	40 cm	30
15906	60 cm	30
15908	80 cm	30
15910	100 cm	30
15912	120 cm	20
15915	150 cm	10
15920	200 cm	20



## SÁRGA VÍZMÉRTÉK, 3 LIBELLÁS

**ALU** **HOBBY**

So.	leírás	
15954	40 cm	60
15956	60 cm	60
15958	80 cm	60
15960	100 cm	30
15962	120 cm	30
15965	150 cm	30
15970	200 cm	30



### NIVELA DIGITÁLIS VÍZMÉRTÉK DL

- pontosság 0,5 mm/m
- felbontása 0,1°
- HOLD funkció a mért érték tárolásához
- profil vastagsága 1,8 mm



So.	leírás	
26215	600 mm	1



### ZSINOR VÍZMÉRTÉK



So.	leírás	
15981		1



So.	leírás	
15980	230 mm	1

### MÁGNESES VÍZMÉRTÉK, 3 LIBELLÁS



### VÍZMÉRTÉK OSZLOPHOZ

- 3 libellás mágneses rögzítő



So.	leírás	
26028		12

### SLAGVÍZMÉRTÉK TÖMLŐVEL



So.	leírás	
15992	üveg csövek - tömlő 10 m	1
15993	üveg csövek - tömlő 15 m	1
15990	slagvízmérték üveg	50
15991	slagvízmérték műanyag	50

**FESTA®****DIGITÁLIS DŐLÉSMÉRŐ**

- 0° - 360°
- Pontosság  $\pm 0,1^\circ$
- felbontás 0,1°
- automatikus kikapcsolás funkció
- HOLD funkció a mért érték tárolásához
- háttérvilágítás kijelző
- méretei 60x60x25 mm
- elem 1xAAA



· bag

mágneses talp

So. leírás

26218



So. leírás

1

**FESTA®****DIGITÁLIS SZÖGMÉRŐ**

- LCD Kijelző
- Mérési tartomány
- Megkülönböztetés
- Pontosság

0° - 360°  
0,1°  
 $\pm 0,3$



So. leírás

26217 200 mm



So. leírás

1

**FESTA®****NIVELA DIGITÁLIS VÍZMÉRTÉK DL**

- LCD Kijelző
- Mérési tartomány
- Megkülönböztetés
- Pontosság

0° - 225°  
0,1°  
 $\pm 0,3$



So. leírás

26216 300 mm



So. leírás

1

NEW



FESTA

## LASER ALL LINE GREEN 3 X 360 °

- 1x vízszintes sík + 2x függőleges sík (zöld sugár)
- önszintezési tartomány  $\pm 4^\circ$
- pontosság 0,2 mm/m
- beltéri: 30 m, kültéri érzékelővel 50 m
- impulzus üzemmód – ajánlott kiegészítő vevő 26209
- tartalmazza: hordtáska, 4xAA alkáli elem, lézeres célpont, szemüveg, 2600 mAh Li-ion akkumulátor, professzionális konzol, töltő, Li-ion akkumulátor bölcsője



No.	Specification
26204	green



NEW



FESTA

## CROSS-LINE GREEN LÉZER

- 1x vízszintes sík + 1x függőleges sík (zöld sugár)
- önszintezési tartomány  $\pm 3^\circ$
- pontosság 0,2 mm/m
- beltéri: 20 m, kültéri érzékelővel 50 m
- impulzus üzemmód – ajánlott kiegészítő vevő 26209
- tartalmazza: hordtáska, 2xAA alkáli elem, konzol



No.	Specification
26201	green





NEW



FESTA

## LÉZER VEVŐ

- impulzusos lézeres eszközökkel való használatra a hatótávolság 50 m-re történő kiterjesztésére
- beleértve: 9 V-os elem, konzol
- 26201, 26204 esetén



No.	Specification
26209	range: 50 m



1

NEW



FESTA

## TÁVOLSÁGMÉRŐ

- mérési tartomány 0,05 - 50 m
- mérési pontosság  $\pm 2$  mm, mértékegység mm/in/ft
- folyamatos mérés, területmérés, térfogatmérés, háromszög láb mérés, LCD FSTN, összeadás/kivonás, max./min. mérőment, max tárhely 100 egység, háttérvilágítás, lézer osztály 630-670 nm, 2. osztály
- üzemi hőmérséklet 0 - 40°C
- mérete 112 x 50 x 25 mm, súlya 90 g
- tartalmazza: hordtáska, 2xAAA alkáli elem



No.	Specification
26211	



1

**Laserliner®****LUXTEST-MASTER**

Professzionális fényerősségmérő készülék

- Fényintenzitás mérése munkahelyeken, irodákban, középületekben és iparban
- Érzékeny fotodiódák cosinus korrekcióval a szélesk rú fényméréshez
- Relatív mérési funkciók referenciaméréshez és összehasonlításához
- Magasszintű funkció a gyors változás regisztrálásához a megvilágítás szintjén.
- Értékek automatikus memorizációjának funkciója.
- Automatikus és kézi kapcsolás
- Nullázási funkció
- Változó mérés: Lux (lm | m2), lábpedál gyertyák (lm | ft2) - Min | max kijelző
- 1/4" állvány



So. leírás

Mérési tartomány: 20 Lux ... 200000 Lux

26520 Pontosság: ± 3% (referencia izzót 2854 K)

Cosinus szögeltérés: ± 2% (30°), ± 6% (60°)

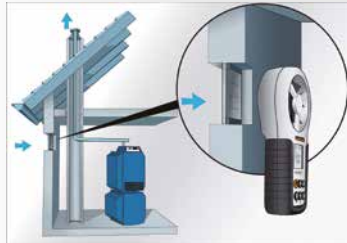

1

leírás

Tartozékok: elemek, hordtáska

**Laserliner®****AIRFLOWTEST-MASTER**

Professzionális anemométer a légáramlás, a térfogatáram és a szélesség mérése

- Integrált érzékelő a környezeti hőmérséklet, relatív páratartalom és harmatpont mérése
- USB interfész a mért adatok tárolására
- PC szoftver - Nagy lapátkerék: 65 mm.
- Min. | Max. kijelző. - 1/4"-os menet az állványra csatlakoztatás hosszútávú mérése
- Világítás, áttekinthető kijelző, állandóan látható értékekkel a környezeti hőmérsékletről és relatív páratartalomról



So. leírás

Áramlási sebesség: 0.80...30 m | s | ± 2%

Környezeti hőmérséklet: -10...60°C | ± 1.5°C

26521 Relatív páratartalom: 20%...80% | ± 3%

Légáramlat: 0...99990 CMM



RECORDING ON A PC

leírás

Tartozékok: Airflow Test-Master, PC szoftver, USB kábel, elemek, hordtáska



1

**Laserliner®****CONDENSESPOT PLUS**

Infravörös hőmérő hőhidak és a pára lecsapódás helyének meghatározásához

- A 8 pontos lézercső pontosan meghatározza a mérési zónát
- Felszíni és harmatponti hőmérséklet mérése
- A kondenzáció lokalizálása hőhid üzemmódban harmatpont-kijelzővel
- A hőhidak és a kondenzvíz problémák lokalizálása hőhid üzemmódban harmatpont-kijelzővel
- Hőmérséklet mérési tartomány: - 40 Celsius foktól +365 Celsius fokig
- Kibocsátási arány: 0,01-től 1,0-ig (állítható)
- Színes riasztás funkció: hőhid figyelmeztetés színes kijelzővel
- 5 emisszió képesség gyors kiválasztása a Gyors előre beállított értékkel vagy pontos meghatározás a numerikus érték megadásával
- Oszlopdiagram kondenzvíz-indikátor
- Objektív 12: 1, megvilágított kijelző

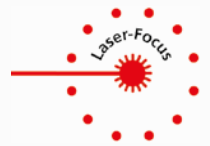

1

2xAA

So.	leírás	
	Az infravörös fénysugár mérési tartománya:	-40°C ... 365°C
	Accuracy:	± -40°C ... 0°C (± 1°C + 0,1°C   1°C) 0°C ... 30°C (± 1°C or ± 1%, felső értéktől függ) >30°C (± 2°C or ± 2%, felső értéktől függ)
26528	Környezeti hőmérséklet: Accuracy	-20°C...65°C ± 1°C (0°C...50°C) ± 2,5°C (<0°C and >50°C)
	Levegő páratartalma: Accuracy	1%...99% ± 3% (20%...80%) ± 5% (<20% and >80%)
	Tartozékok:	elemek   baterie

**Laserliner®****COMPACTCROSS - LASER PLUS**

Automatikus keresztvonalas lézer a csempék, fal födémek, ablakok és ajtók szintbe igazításához

- A lejtő-mód funkció egy extra, amely lehetővé teszi a szint átmenetek meghatározását
- RX-ready: beépített kézi vevőkészülék üzemmódban
- Bluetooth a készülék távirányításához
- Automatikus szintezési tartomány: 4 fok, pontosság: 0,35 mm/m



2xAA



So.	leírás	
26037	Tartozékok:	baterie



1

**FESTA**

## JELŐŐ CERUZA, FÉM, HB GAFIT BETÉTEL



So.	leírás	
13262	150 mm	20

**FESTA**

## CERUZA CSERÉLHETŐ HEGGYEL

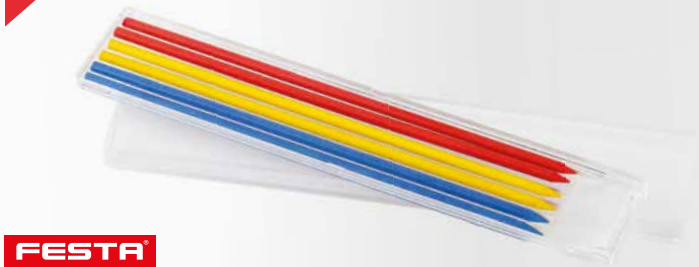

So.	leírás	
13279	ceruza + tartalék hegy HB	24
13284	5 db tartalék hegy	20

**NEW****FESTA**

## SZÍNES CERUZA

13262 -ért



Č.p.	Specifikace	
13267	2x žlutá 2x červená 2x modrá	1

**FESTA**

## FEKETE CERUZA HB

13262 -ért



Č.p.	Specifikace	
13263	6x černá	20

**FESTA**

## ÁCSCERUZA HB



So.	leírás	
13270	HB · 180 mm	96
13271	HB · 180 mm · készlet 3 db	32
13265	HB · 250 mm	96

**FESTA**

## ÁCSCERUZA HB



So.	leírás	
13269	HB · 180 mm	50
13266	HB · 250 mm	50



**FESTA**

ÁCSCERUZA HB



MOQ  
12

So.	leírás	
13272	HB · 250 mm	96
13264	HB · 250 mm · nyomtatás nélkül	96



**FESTA**

ÁCSCERUZA HB



MOQ  
50

So.	leírás	
13268	250 mm	50



**FESTA**

HÁROMSZÖG ALAKÚ ÁCSCERUZA HB



MOQ  
12

So.	leírás	
13278	250 mm	96



ÁCSCERUZA HB



MOQ  
12

So.	leírás	
13280	180 mm	96



**FESTA**

ÁCSCERUZA 6H



MOQ  
12

So.	leírás	
13275	6H · 250 mm	96



**FESTA**

ÜVEGRE ÉS KERÁMIÁRA



MOQ  
12

So.	leírás	
13273	175 mm, piros grafit - üvegre és kerámiára	144

**FESTA**

### ÁCSCERUZA

MOQ
12

So.	leírás
13274	175 mm, kétszínű



96



### ÁCSCERUZA PIROS SZÍNŰ

MOQ
12

So.	leírás
13276	175 mm



144



csiszolópapír

### CERUZAHEGYZŐ

So.
13261



12



ALKOHOLOS FILCTOLL



- extra erős tipp
- Zsíros és nedves felületek jelölésére is



MOQ  
12

So.	leírás	
13216	piros	12
13217	fekete	12
13218	kék	12
13219	zöld	12



ALKOHOLOS FILCTOLL



- 2 típusú jelölő tőfej
- Zsíros és nedves felületek jelölésére is



So.	leírás		
13227	fehér	ALU	40
13222	fehér	PVC	12
13228	piros	ALU	40
13229	fekete	ALU	40
13230	kék	ALU	12
13231	zöld	ALU	12



ALKOHOLOS FILCTOLL



MOQ  
12



So.	leírás	
13214	fehér	12
13225	piros	12
13226	fekete	12
13223	kék	12
13224	zöld	12



ALKOHOLOS FILCTOLL



MOQ  
12



So.	leírás	
13235	piros	12
13236	fekete	12
13237	kék	12
13238	zöld	12



**NEW**



**NEW**



**ALKOHOLOS FILCTOLL - 2 HEGYŰ**

MOQ  
**12**



So. 13206    Leírás ○ fehér    12



**FESTA**

**ALKOHOLOS FILCTOLL**



So. 13246    Leírás ● fekete    10

**NEW**

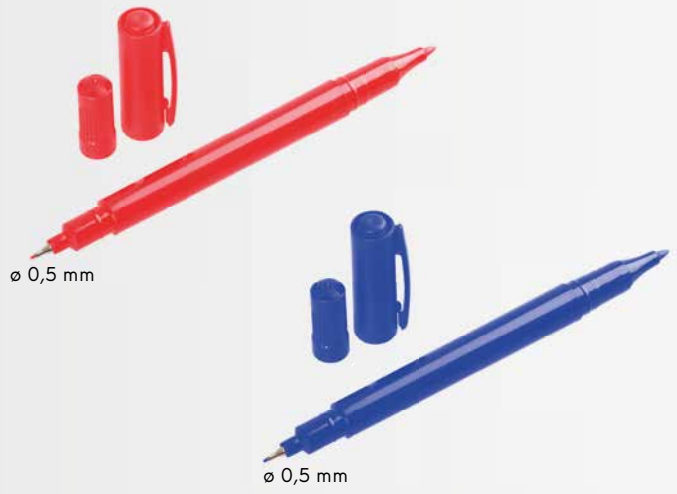

**ALKOHOLOS FILCTOLL - 2 HEGYŰ**

MOQ  
**12**



So. 13207    Leírás ● piros    12  
13208    ● kék    12



**ALKOHOLOS FILCTOLL MINI**

· hossz 9 cm

MOQ  
**72**



So. 13205    leírás ● ● ● ●    72



**ALKOHOLOS FILCTOLL - 2 HEGYŰ**

MOQ  
**12**



So. 13212    leírás fekete    12





**FESTA**

RAJZTŰ, VÉSŐ TŰ



So.	leírás	
13281	150 mm	50



KÖRZŐ



So.	leírás	
13285	200 mm	10



**FESTA**

RAJZTŰ, VÉSŐ TŰ



So.	leírás	
13282	200 mm	50



KRÉTA, FEHÉR

12x



So.	leírás	
13260	12 x 12 x 80 mm	46



**FESTA**

ZSÍRKRÉTA KÉSZLET 5 DB

· Ø 13 x 110 mm

5x



So.	leírás		So.	leírás	
13240	5 szín	20	13243	● sárga	20
13241	● piros	20	13244	● zöld	20
13242	● fekete	20	13245	○ fehér	20



ZSÍRKRÉTA KÉSZLET 6 DB

6x



So.	leírás	
13277	● ● ○ ● ● ●	88

## SPRAY FLUORESZKÁLÓ TRACKMARKER 500ML

- Nagyfokú láthatóság a fl uoreszkáló pigment miatt
- Biztonsági kupak
- Gyors száradás 10 perc.
- Tartósság 3 hónap
- Használat - beton, aszfalt, fű, kavics, homok, kő, fa

MADE IN  
**EU**

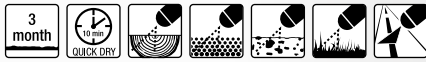

So.	leírás	
13250	● sárga	12
13251	● piros	12
13252	● narancs	12
13253	● zöld	12
13254	● rózsaszín	12
13249	● kék	12



## SPRAY FLUORESZKÁLÓ MARK 6M FLUO 500 ML

- Nagyfokú láthatóság a fl uoreszkáló pigment miatt
- Biztonsági kupak
- Gyors száradás 10 perc.
- Tartósság 6 hónap
- Használat - beton, aszfalt, fű, kavics, homok, kő, fa

MADE IN  
**EU**



So.	leírás	
13360	● sárga	12
13361	● piros	12
13362	● narancs	12
13363	● zöld	12
13364	● rózsaszín	12
13365	○ fehér	12



## SPRAY FLUORESZKÁLÓ FLUO 500 ML

- Nagyfokú láthatóság a fl uoreszkáló pigment miatt
- Biztonsági kupak
- Gyors száradás 10 perc.
- Tartósság 12 hónap
- Használat - beton, aszfalt, fű, kavics, homok, kő, fa

MADE IN  
**EU**



So.	leírás	
13350	● sárga	12
13351	● piros	12
13352	● narancs	12
13353	● zöld	12
13354	● rózsaszín	12
13355	○ fehér	12



## SPRAY FLUORESZKÁLÓ IDEAL 500 ML

- Nagyfokú láthatóság a fluoreszkáló pigment miatt
- Biztonsági kupak
- Gyors száradás 10 perc.
- Tartósság 12 hónap
- Használat - beton, aszfalt, fű, kavics, homok, kő, fa



So.	leírás	
13255	● sárga	12
13256	● piros	12
13257	● narancs	12
13258	● zöld	12
13259	● rózsaszín	12



## GURULÓ JELŐLŐFESTÉK TARTÓ

· permetezéshez Trackmarker a Fluo



So.	leírás	
13296		1

## JELŐLŐFESTÉK TARTÓ PISZTOLY

· permetezéshez Trackmarker a Fluo



So.	leírás	
13295		1



60

FOGÓ



66

FOGÓ SIKO



68

CSAPSZEGVÁGÓ



70

LEMEZVÁGÓ OLLÓ



73

DUGÓKULCS KLT.



82

DUGÓKULCS FEJ



87

VILLÁSKULCS



93

CSAVARHÚZÓ



101

BITEK



110

IMBUSZKULCS



115

KALAPÁCS

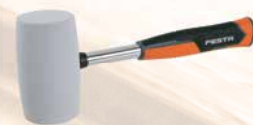

120

KÉZIKALAPÁCS



122

FEJSZE



125

PAJSZER



126

FAVÉSŐ

## SZERSZÁMOK

58 - 159



129

TÚZÓGÉP



131

PILLANATSZORÍTÓ



134

MUNKAPAD



136

POPSZEGECS FOGÓ



140

HEGESZTŐPAJZS  
ÖNSÖTÉTEDŐ

143

MENÉTES SZÁRAK,  
ALÁTÉTEK

144

LEVEGŐPISZTOLY RÖVID



149

BIZTONSÁGI TERMÉKEK



155

SZERSZÁM TARTÓK

# FESTA®



**ERGONOMIC handle**

STANDARD +30% FESTA



**FESTA**  
FOGÓ KOMBINÁLT

DIN 5749 TUV GS CrV HRC 58-62 ERGO HANDLE

R.s.	leírás	
17101	160 mm	6
17102	180 mm	6
17103	200 mm	6



**FESTA**  
OLDALCSÍPŐ FOGÓ

DIN 5749 TUV GS CrV HRC 58-62 ERGO HANDLE

R.s.	leírás	
17148	180 mm	6

**FESTA**  
OLDALCSÍPŐ FOGÓ

DIN 5749 TUV GS CrV HRC 58-62 ERGO HANDLE

R.s.	leírás	
17104	160 mm	6
17105	180 mm	6



**FESTA**  
TELEFON FOGÓ, EGYENES

DIN 5749 TUV GS CrV HRC 58-62 ERGO HANDLE

R.s.	leírás	
17140	160 mm	6
17142	200 mm	6

**FESTA**  
TELEFON FOGÓ, HAJLÍTOTT

DIN 5749 TUV GS CrV HRC 58-62 ERGO HANDLE

R.s.	leírás	
17145	160 mm	6
17146	200 mm	6

**FESTA**

## FOGÓ KOMBINÁLT

DIN 5746		TUV	GS	HRC 50-55	ERGO HANDLE	
R.s.	leírás					
17001	160 mm	6				
17002	180 mm	6				
17003	200 mm	6				

**FESTA**

## OLDALCSÍPÓ FOGÓ

DIN 5749		TUV	GS	HRC 50-55	ERGO HANDLE	
R.s.	leírás					
17004	160 mm	6				
17005	180 mm	6				

**FESTA**

## ERŐSÍTETT OLDALCSÍPÓ FOGÓ

DIN 5749		TUV	GS	HRC 50-55	ERGO HANDLE	
R.s.	leírás					
17108	180 mm	6				

**FESTA**

## HOMLOKCSÍPÓ FOGÓ

DIN 5749		TUV	GS	HRC 50-55	ERGO HANDLE	
R.s.	leírás					
17110	160 mm	6				

**FESTA**

## TELEFON FOGÓ, EGYENES

DIN 5745		TUV	GS	HRC 50-55	ERGO HANDLE	
R.s.	leírás					
17006	160 mm	6				
17011	200 mm	6				

**FESTA**

## TELEFON FOGÓ, HAJLÍTOTT

DIN 5745		TUV	GS	HRC 50-55	ERGO HANDLE	
R.s.	leírás					
17007	160 mm	6				
17008	200 mm	6				

**FESTA**

## LAPOS FOGÓ

DIN 5746		TUV	GS	HRC 50-55	ERGO HANDLE	
R.s.	leírás					
17009	160 mm	6				

**FESTA**

## SZEMES FOGÓ

DIN 5745		TUV	GS	HRC 50-55	ERGO HANDLE	
R.s.	leírás					
17010	160 mm	6				

**FESTA**

## FOGÓ KÁBELCSUPASZÍTÓ

DIN 5744		TUV	GS	HRC 50-55	ERGO HANDLE	
R.s.	leírás					
17024	160 mm	6				



## FOGÓ KOMBINÁLT

DIN 5746		TUV	GS		
R.s.	leírás				
17094	160 mm	6			
17095	180 mm	6			
17096	200 mm	6			



## OLDALCSÍPÓ FOGÓ

DIN 5749		TUV	GS		
R.s.	leírás				
17097	160 mm	6			
17098	180 mm	6			



## TELEFON FOGÓ, EGYENES

DIN 5745		TUV	GS		
R.s.	leírás				
17099	160 mm	6			
17100	200 mm	6			



**FESTA**

## VDE KOMBINÁLT FOGÓ

△ 1000 V △  
IEC/EN60900:2004

DIN 5746

CrV

HRC 58-62



R.sz.	leírás	
17125	160 mm	6
17126	180 mm	6
17127	200 mm	6

**FESTA**

## VDE OLDALCSÍPŐ FOGÓ

△ 1000 V △  
IEC/EN60900:2004

DIN 5749

CrV

HRC 58-62



R.sz.	leírás	
17128	160 mm	6

**FESTA**

## VDE HUZALVÁGÓ FOGÓ

△ 1000 V △  
IEC/EN60900:2004

CrV

HRC 58-62



R.sz.	leírás	
17130	160 mm	6

**FESTA**

## TELEFON FOGÓ, EGYENES

△ 1000 V △  
IEC/EN60900:2004

DIN 5745

CrV

HRC 58-62



R.sz.	leírás	
17133	160 mm	6

**FESTA**

## TELEFON FOGÓ, HAJLÍTOTT

△ 1000 V △  
IEC/EN60900:2004

DIN 5745

CrV

HRC 58-62



R.sz.	leírás	
17135	160 mm	6

**FESTA**

## VDE SZEMES FOGÓ

△ 1000 V △  
IEC/EN60900:2004

DIN 5745

CrV

HRC 58-62



R.sz.	leírás	
17137	160 mm	6

**FESTA**VDE FOGÓ  
KÁBELCSUPASZÍTÓ

△ 1000 V △  
IEC/EN60900:2004

CrV

DIN 5744



R.sz.	leírás	
17138	160 mm	6

AUTOMATA KÁBEL  
CSUPASZÍTÓ FOGÓ

R.sz.	leírás	
17180	Ø 0,75 - 2,5 mm	12



## BLANKOLÓ FOGÓ

R.sz.	leírás	
17181	Ø 0,60 - 2,6 mm	10

NEW

**FESTA**

## KÁBELCSUPASZÍTÓ

AWG	mm <sup>2</sup>
10	6,0
12	4,0
14	2,5
16	1,5
18	1,0
20	0,5

· RG6/59 koaxiális kábel  
· kisfeszültségű kábel Ø 8 - 13 mm

R.sz.	leírás	
16202	125 mm	



10

**NEW**



**FESTA**

**FOGÓ FINOM KÁBELEKHEZ**

· max Ø 0,2 - 2,1 mm

**CrV**

R.s.   No.	Leírás   Specification	
17047	140 mm	10



**FESTA**

**FOGÓ KOMBINÁLT MINI**

R.s.	leírás	
17041	110 mm	12



**FESTA**

**MINI ÖLDALCSÍPÓ FOGÓ**

R.s.	leírás	
17042	110 mm	12



**FESTA**

**MINI HOMLOKCSÍPÓ FOGÓ**

R.s.	leírás	
17043	100 mm	12



**FESTA**

**MINI LAPOSCSÖRŰ FOGÓ**

R.s.	leírás	
17044	120 mm	12



**FESTA**

**MINI SZEMES FOGÓ**

R.s.	leírás	
17045	120 mm	12



**FESTA**

**MINI FOGÓ KLT.**

**4x**

R.s.	leírás	
17040		6



R.s.	leírás	
17025	klt	10



**FESTA**

**ZÉGER FOGÓ**

R.s.	leírás	
17190	180 mm belső	6
17191	180 mm külső	6



**FESTA**

**ZÉGER FOGÓ**

R.s.	leírás	
17192	180 mm belső	15
17193	180 mm külső	15



**ZÉGER FOGÓ**

R.s.	leírás	
17025	klt	10



**FESTA**

MULTIFUNKCIÓS  
FOGÓ

· 9 funkció  
· Eset

**CrV**

R.s. leírás

16232



12



**FESTA**

MULTIFUNKCIÓS  
FOGÓ

· Kerítéshez

**CrV**

R.s. leírás

17109 270 mm



4



PATENTFOGÓ

R.s. leírás

17034 220 mm



5



PATENTFOGÓ

R.s. leírás

17036 260 mm



5



PATENTFOGÓ

R.s. leírás

17035 220 mm



10



PATENTFOGÓ

R.s. leírás

17023 220 mm



6



**FESTA**  
VÍZPUMPAFOGÓ

CrV

R.sz.	leírás	rozsah őelíсті	
17059	180 mm	0 - 30 mm	6
17061	250 mm	0 - 30 mm	6
17062	300 mm	0 - 40 mm	6
17080	400 mm	0 - 84 mm	4



**FESTA**  
VÍZPUMPAFOGÓ

CrV

R.sz.	leírás	rozsah őelíсті	
17084	250 mm	0 - 30 mm	6



**FESTA**  
VÍZPUMPAFOGÓ

CrV

· large range of jaws

R.sz.	leírás	rozsah őelíсті	
17086	250 mm	0 - 50 mm	6



**FESTA**  
VÍZPUMPAFOGÓ

CrV

R.sz.	leírás	rozsah őelíсті	
17081	180 mm	0 - 30 mm	6
17014	250 mm	0 - 30 mm	6
17082	300 mm	0 - 50 mm	6



**FESTA**  
VÍZPUMPAFOGÓ

CrV

R.sz.	leírás	rozsah őelíсті	
17079	250 mm	0 - 50 mm	6



**FESTA**  
VÍZPUMPAFOGÓ

CrV

R.sz.	leírás	rozsah őelíсті	
17012	250 m	0 - 40 mm	6
17060	300 mm	0 - 50 mm	10



**VÍZPUMPAFOGÓ**

R.sz.	leírás	rozsah őelíсті	
17013	250 mm	0 - 30 mm	6
17033	300 mm	0 - 50 mm	6



**MŰANYAG VÉDŐBETÉT FOGÓKHOZ**

· alkalmas 17061 és 17079 hez

R.sz.	leírás	
17085	1 pár	1

**FESTA**

CSŐFOGÓ, SZABÁLYZÓ ANYÁVAL 45°, S

CrV



R.sz.	leírás	
17067	1"   330 mm	1
17068	1,5"   420 mm	1
17069	2"   540 mm	1

**FESTA**

CSŐFOGÓ, SZABÁLYZÓ ANYÁVAL 90°

CrV



R.sz.	leírás	
17075	1"   330 mm	1
17076	1,5"   420 mm	1
17077	2"   540 mm	1

**FESTA**

CSŐFOGÓ, SZABÁLYZÓ ANYÁVAL 90°

CrV



R.sz.	leírás	
17070	2,5"   355 mm	12
17071	3"   455 mm	8
17072	3,5"   610 mm	10

**FESTA**

CSŐFOGÓ, SZABÁLYZÓ ANYÁVAL

CrV

R.sz.	leírás	
17063	230 mm	6
17064	300 mm	6



CSŐFOGÓ, SZABÁLYZÓ ANYÁVAL

R.sz.	leírás	
17065	260 mm	36
17066	300 mm	36

**FESTA**

**BETONVASVÁGÓ**

- acél vezetékek
- ACRS kábelek
- Repülőgépkábelek

**CrV**

max. Ø  
12 mm



R.sz.	leírás	
17039	24'   610 mm	8



**FESTA**

**DRÓTVÁGÓ FOGÓ**

- acél vezetékek
- ACRS kábelek
- Repülőgépkábelek

**CrV**

max. Ø  
6 mm



R.sz.	leírás	
17029	200 mm	6



**FESTA**

**CSAPSZEGVÁGÓ, KÁBELVÁGÓVAL**

Kábelekhez és vezetékekhez

**Cr-Mo**

**HRC 58-62**



R.sz.	leírás	max. Ø drátu	max. Ø lanka	max. Ø kabele	
17055	14'   360 mm	max. 5 mm < 45 HRC	max. 3,5 mm	max. 8 mm	1
17056	18'   460 mm	max. 6 mm < 45 HRC	max. 5 mm	max. 10 mm	1
17057	24'   610 mm	max. 8 mm < 45 HRC	max. 7 mm	max. 12 mm	1
17058	30'   760 mm	max. 10 mm < 45 HRC	max. 9 mm	max. 14 mm	1
17046	35'   900 mm	max. 12 mm < 45 HRC	max. 10 mm	max. 16 mm	1



**FESTA**

**CSAPSZEGVÁGÓ**

**Cr-Mo**

**HRC 58-62**

R.sz.	leírás	max. Ø drátu	
17051	14'   360 mm	max. 5 mm < 45 HRC	1
17052	18'   450 mm	max. 6 mm < 45 HRC	1
17053	24'   610 mm	max. 8 mm < 45 HRC	1
17054	30'   760 mm	max. 10 mm < 45 HRC	1
17048	36'   910 mm	max. 12 mm < 45 HRC	1



**CSAPSZEGVÁGÓ**

R.sz.	leírás	max. Ø drátu	
17028	14'   350 mm	max. 5 mm < 30 HRC	30
17020	18'   450 mm	max. 6 mm < 30 HRC	6
17021	24'   610 mm	max. 8 mm < 30 HRC	10
17022	30'   760 mm	max. 10 mm < 30 HRC	5



**NEW**



**FESTA**

**DRÓTVÁGÓ**

puha huzal: Ø 6 mm  
 közepesen kemény huzal: Ø 5 mm  
 kemény huzal: Ø 4 mm

**CrV**

R.sz.	Leírás	
17078	200 mm	12



**DRÓTVÁGÓ**

max. Ø  
5 mm

R.sz.	leírás	
17038	8"   210 mm	10



**FESTA**

**HARAPÓ FOGÓ**

**CrV**

R.sz.	leírás	
17300	160 mm	1
17301	180 mm	10
17302	200 mm	6
17303 <b>NEW</b>	250 mm	1



**FESTA**

**RABITZ FOGÓ**

**CrV**

R.sz.	leírás	
17305	220 mm	5
17306 <b>NEW</b>	250 mm	1
17304	275 mm	6



**HARAPÓ FOGÓ**

R.sz.	leírás	
17015	160 mm	6
17016	180 mm	6
17017	200 mm	6



**RABITZ FOGÓ**

R.sz.	leírás	
17019	220 mm	6
17083	275 mm	6



**FESTA**

BÁDOGOS FOGÓ EGYENES

R.sz.	leírás
17089	150 x 215 mm



**FESTA**

BÁDOGOS FOGÓ EGYENES

R.sz.	leírás
17093	95 x 270 mm



**FESTA**

BÁDOGOS FOGÓ EGYENES

R.sz.	leírás
17090	60 x 280 mm



**FESTA**

BÁDOGOS FOGÓ 45° FOKBAN HAJLÍTOTT

R.sz.	leírás
17091	60 x 280 mm



**FESTA**

BÁDOGOS FOGÓ 90° FOKBAN HAJLÍTOTT

R.sz.	leírás
17092	60 x 260 mm



**FESTA**

LEMEZVÁGÓ OLLÓ

**Cr-Mo** **HRC 58-62**



R.sz.	leírás	
17112	egyenes	40   260 mm
17117	jobbos	40   260 mm
17122	balos	40   260 mm



**FESTA**

LEMEZVÁGÓ OLLÓ

**Cr-Mo** **HRC 58-62**



R.sz.	leírás	
17111	egyenes	40   250 mm
17116	jobbos	40   250 mm
17121	balos	40   250 mm





**FESTA**

LEMEZVÁGÓ OLLÓ

CrV



R.sz.	leírás	
17170	50   250 mm	6



**FESTA**

LEMEZVÁGÓ OLLÓ

CrV



R.sz.	leírás	
17156	60   245 mm	6



**FESTA**

LEMEZVÁGÓ OLLÓ

CrV



R.sz.	leírás	
17155	70   260 mm	6



LEMEZVÁGÓ OLLÓ

CrV

R.sz.	leírás	
17167	70   300 mm	5



LEMEZVÁGÓ OLLÓ

CrV

R.sz.	leírás	
17165	60   250 mm	5



LEMEZVÁGÓ OLLÓ

CrV

R.sz.	leírás	
17169	35   250 mm	5



LEMEZVÁGÓ OLLÓ

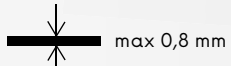

R.sz.	leírás	
17186	265 mm	6

LEMEZVÁGÓ ADAPTER

- maximális lemezvastagság :
- 1,8 mm - acél
  - 1,2 mm - Rozsdamentes
  - 2 mm - műanyag, alumínium, réz



R.sz.	leírás	
20363		5

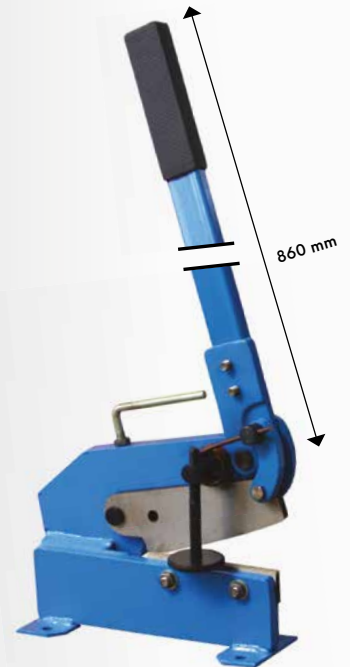

KAROS LEMEZVÁGÓ

	17175	17177
	max. 4mm	5mm
	max. Ø10mm	Ø12mm
	max. 8x8mm	10x10mm

R.sz.	leírás	
17175	150 mm	1
17177	250 mm	1



**FESTA**

**FESTA**

LYUKASZTÓ FOGÓ

DARABOLÓ OLLÓ, PROFILOKHOZ

lecek, csövek, profilok

R.sz.	leírás	
17185	Ø 2; 2,5; 3; 3,5; 4; 4,5 mm	12

R.sz.	leírás	
17050	60   220 mm      ø 17 mm, ø 20 mm, ø 27 mm	8



MŰSZAKI OLLÓ

MŰSZAKI OLLÓ

INOX

INOX



R.sz.	leírás	
16420	60   200 mm	12

R.sz.	leírás	
17159	65   220 mm	12



MŰSZAKI OLLÓ

OLLÓ

INOX

INOX

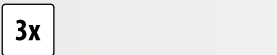

R.sz.	leírás	
17158	50   150 mm	10

R.sz.	leírás	
16401	3 db	48



MŰSZAKI OLLÓ

OLLÓ

INOX

INOX



R.sz.	leírás	
16405	14 cm	24
16406	17 cm	24
16407	19 cm	24
16408	21,5 cm	12

R.sz.	leírás	
17160	70   210 mm	12

# FESTA®

10 years  
guarantee

- Felhasználás iparban és szervízben
- Kiváló minőségű króm vanádium-acél
- racsnis villás kulcs 72 polírozott foggal a legpontosabb munkához
- Minden alkatrész megfelel a DIN-szabványoknak
- Horganyzott fej a tökéletes fogáshoz
- Tartós hordtáska fém zárral és Zsanérokkal

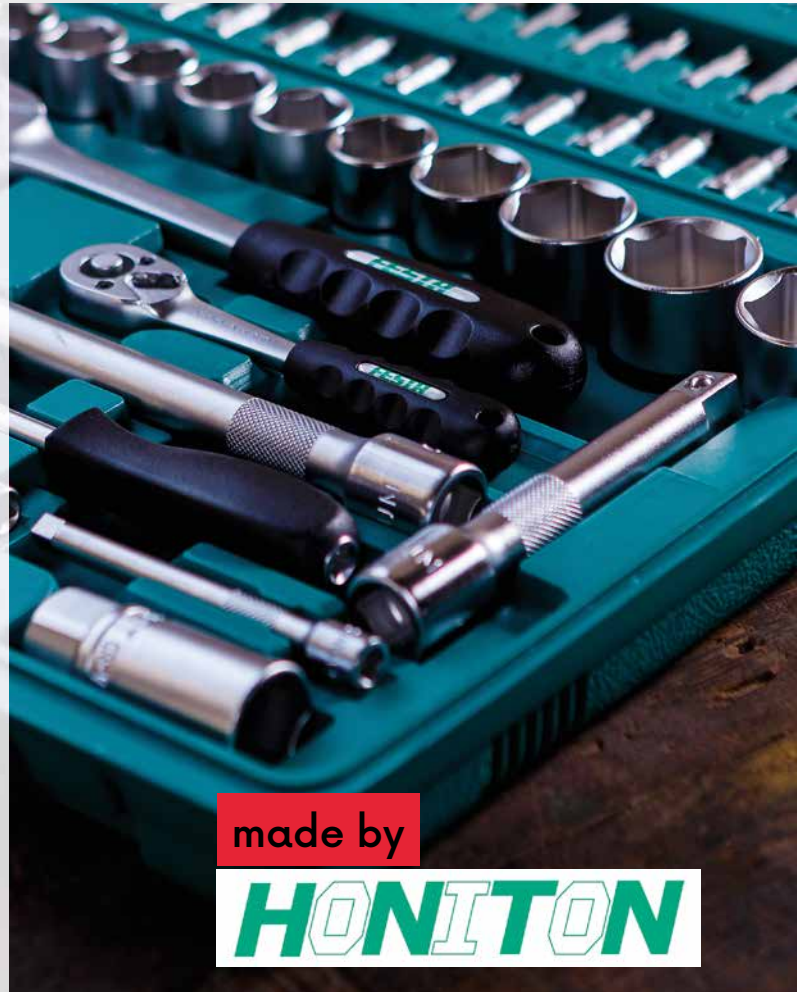



made by

## HONITON

**FESTA** made by **HONITON**

### DUGÓKULCS KLT.

-  1/2" · 72 T
-  1/2" · 125 mm
-  1/2" · 8-9-10-11-12-13-14-15-17-19-22 mm

**CrV** **1/2"** **13x**

R.s.

leírás

17210







10 years  
guarantee



1

**FESTA** made by **HONITON**

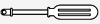
### DUGÓKULCS KLT.

-  1/4" · 72 T
-  1/4" · 50 mm, 100 mm
-  1/4"
-  1/4"
-  1/4" · 4-4,5-5-5,5-6-7-8-9-10-11-12-13 mm

**CrV** **1/4"** **17x**

R.s.

leírás

17211







10 years  
guarantee

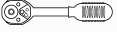
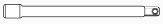

1

**FESTA** made by **HONITON**

**DUGÓKULCS KLT.**

-  1/2"
-  1/2" · 125 mm, 250 mm
-  1/2"
-  16 mm, 21 mm
-  1/2"
-  1/2" · 10-11-12-13-14-15-16-17-18-19-20-21-22-23-24-27-30-32 mm

**CrV** **1/2"** **25x**

R.s. leírás  
17212













10 years guarantee



4

**FESTA** made by **HONITON**

**DUGÓKULCS KLT.**

-  1/2", 1/4" · 72 T
-  1/2", 1/4"
-  1/4" · 150 mm
-  1/4" · 100 mm
-  1/2", 1/4"
-  1/2" · 125 mm, 250 mm
-  1/4" · 4-4,5-5-5,5-6-7-8-9-10-11-12-13 mm
-  1/2" · 10-11-12-13-14-15-17-19-21-22-24-27-30-32 mm
-  16 mm, 21 mm
-  18x
-  Inbus 3x

**CrV** **1/2"** **1/4"** **59x**

R.s. leírás  
17214









10 years guarantee

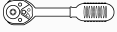

4

**FESTA** made by **HONITON**

**DUGÓKULCS KLT.**

-  1/2" · 72 T
-  1/2" · 125 mm, 250 mm
-  1/2"
-  16 mm, 21 mm
-  1/2"
-  1/2"
-  1/2" · 8-9-10-11-12-13-14-15-16-17-18-19-20-21-22-23-24-27-30-32 mm

**CrV** **1/2"** **28x**

R.s. leírás  
17213





10 years guarantee



4

**FESTA** made by **HONITON**

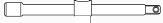
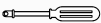
**DUGÓKULCS KLT.**

-  1/4" · 72 T
-  1/4" · 50 mm
-  1/4"
-  1/4"
-  1/4" · 4-4,5-5-5,5-6-7-8-9-10-11-12-13 mm

**CrV** **1/4"** **16x**

R.s. leírás  
17215



10 years guarantee



1



**FESTA** made by **HONLTON**

**DUGÓKULCS KLT.**

- 1/2" · 72 T
- 1/2" · 125 mm, 250 mm
- 1/2"
- 16 mm, 21 mm
- 1/2"
- 1/2" · 10-11-12-13-14-15-16-17-18-19-20-21-22-23-24-27-30-32 mm

**CrV** **1/2"** **25x**

R.s. leírás

17216



10 years guarantee



10

**FESTA** made by **HONLTON**

**DUGÓKULCS KLT.**

- 1/4" · 72 T
- 1/4" · 50 mm
- 1/4"
- 1/4"
- 1/4"
- 1/4" · 4-4,5-5-5,5-6-7-8-9-10-11-12-13 mm
- 12x

IMBUS 3x

**CrV** **1/4"** **32x**

R.s. leírás

17217



10 years guarantee



1

**FESTA** made by **HONLTON**

**DUGÓKULCS KLT.**

- 1/2", 1/4" · 72 T
- 1/2", 1/4"
- 1/4" 150 mm
- 1/4" 100 mm
- 1/2", 1/4"
- 1/2" · 125 mm, 250 mm
- 1/4" · 4-4,5-5-5,5-6-7-8-9-10-11-12-13 mm
- 1/2" · 10-11-12-13-14-15-17-19-21-22-24-27-30-32 mm
- 16 mm, 21 mm
- 16x

IMBUS 3x

**CrV** **1/4"** **1/2"** **56x**

R.s. leírás

17218



10 years guarantee



4

**FESTA** made by **HONLTON**

**DUGÓKULCS KLT.**

- 1/2", 1/4" · 72 T
- 1/2", 1/4"
- 1/4"
- 1/4" · 50 mm, 100 mm
- 1/2", 1/4"
- 1/2", 1/4"
- 1/2" 125 mm, 250 mm
- 1/4" · 4-4,5-5-5,5-6-7-8-9-10-11-12-13-14 mm
- 1/2" · 10-11-12-13-14-15-17-19-21-22-24-27-30-32 mm
- 1/4" · 6-7-8-9-10-11-12-13 mm
- 1/2" · 14-15-17-19-22 mm
- 16 mm, 21 mm
- 34x

IMBUS 3x

**CrV** **1/4"** **1/2"** **94x**

R.s. leírás

17219







10 years guarantee

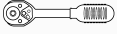
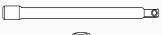
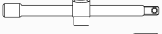

3

**FESTA** made by **HONITON**

**DUGÓKULCS KLT.**

-  1/2" · 72 T
-  1/2" · 125 mm, 250 mm
-  1/2"
-  16 mm, 21 mm
-  1/2"
-  1/2" · 8-9-10-11-12-13-14-15-16-17-18-19-20-21-22-23-24-27-30-32 mm

**CrV** **1/2"** **27x**

R.s. leírás  
**17225**







10 years guarantee



4

**FESTA** made by **HONITON**

**DUGÓKULCS KLT.**

-  3/4" · 72 T
-  3/4" · 100 mm, 200 mm
-  3/4" · 460 mm
-  3/4" · 22-24-27-30-32-36-38-41-46-50 mm

**CrV** **3/4"** **14x**

R.s. leírás  
**17226**







10 years guarantee

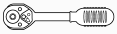

1

**FESTA** made by **HONITON**

**DUGÓKULCS KLT.**

-  3/4" · 72 T
-  3/4" · 100 mm, 200 mm, 400 mm
-  3/4" · 460 mm
-  3/4" · 19-21-22-23-24-26-27-29-30-32-35-36-38-41-46-50 mm

**CrV** **3/4"** **21x**

R.s. leírás  
**17227**



10 years guarantee



1



**FESTA** made by **HONITON**

**DUGÓKULCS FEJ**

-  1/2" HEX · 4-5-6-7-8-10-12-14-17 mm

**CrV** **1/2"** **9x**

R.s. leírás  
**17345**

10 years guarantee



1



**FESTA** made by **HONITON**

**DUGÓKULCS FEJ**

-  T20-T25-T27-T30-T40-T45-T50-T55-T60 mm

**CrV** **1/2"** **9x**

R.s. leírás  
**17346**

10 years guarantee



1



**FESTA** made by **HONITON**

DUGÓKULCS FEJ

Cr-Mo 1/2" 3x

R.sz.	leírás	
17336	17 mm	5
17337	19 mm	5
17338	21 mm	5



**FESTA** made by **HONITON**

DUGÓKULCS FEJ

1/2" · 17-19-21 mm

Cr-Mo 1/2" 3x

R.sz.	leírás	
17335		1



**FESTA** made by **HONITON**

RACSNIS

CrV

R.sz.	leírás	
17220	1/4" 36 fogú	20
17222	3/8" 36 fogú	10
17224	1/2" 36 fogú	6
17208	1/2" 72 fogú	6



DRIVELOCK DUGÓKULCS FEJ

4-5-5,5-6-7-8-9-10-11-12-13 mm

CrV 1/4" 12x

R.sz.	leírás	
17250		10



TORX DUGÓKULCS FEJ

1/4" · 5-6-7-8-10

1/2" · 12-14-16-18

CrV 1/2" 1/4" 9x

R.sz.	leírás	
17255		4



# FESTA®

10 years guarantee



Cr-Mo

- Felhasználás iparban és szervízben
- Kiváló minőségű króm vanádium-acél
- racsnis villás kulcs 72 polírozott foggal a legfontosabb munkához
- Minden alkatrész megfelel a DIN-szabványoknak
- Horganyzott fej a tökéletes fogáshoz
- Tartós hordtáska fém zárakkal és zsanérokkal



**FESTA**

## SZERSZÁM KLT.

- |  |  |
|--|--|
| 1/2" · 1/4"                                  | 1/4" · S 4 · 5.5 · 6.5                 |
| 1/4" · 4-5-6-7-8-9mm                         | 1/4" · PH 1 · 2 · 3                    |
| 1/2" · 10-12-13-14-17-19mm                   | 1/4" · PZ 2 · 3                        |
| 1/4" · 4-4.5-5-5.5-6-7-8-9-10-11-12-13-14mm  | 1/4" · H 3 · 4 · 5 · 6                 |
| 1/2" · 12-13-14-15-16-17-18-19-20-21-22-24mm | 1/4" · T 8 · 10 · 15 · 20 · 25         |
| 1/2" · 1/4"                                  | 1/4" · TTa · 10 · 15 · 20 · 25 · 40    |
| 1/4" · 1/4" →  A4                            | 2 · 2.5 · 3 · 4 · 5 · 6 · 7 · 8 · 10mm |
| 1/4" · 150mm                                 | 8-9-10-11-12-13-14-15-16-17-18-19mm    |
| 1/2" · 254mm                                 | S 4x100 · 6.5x150                      |
| 1/2" · 1/4"                                  | PH 2x100 · 3x150                       |
| 1/2" · 16-21mm                               | 180mm                                  |
| 1/4" · 150mm                                 | 160mm                                  |
| 1/2" · E10-E12-E14-E16-E18-E20-E22-E24       | 160mm                                  |
| 1/4" · S 3 · 4 · 5 · 6                       | 250mm                                  |
| 1/4" · PH 0 · 1 · 2                          | 300g                                   |
| 1/4" · PZ 0 · 1 · 2                          |  |



R.sz. leírás  
17238 122 db



1

**FESTA**

## DUGÓKULCS KLT.

- |   |
|---|
| 1/2" · 72T                              |
| 1/2" · 125 mm                           |
| 1/2" · 10-11-12-13-14-15-17-19-22-24 mm |



R.sz. leírás  
17245 15



15

**FESTA**

## DUGÓKULCS KLT.

- |   |
|---|
| 1/2" · 72T                              |
| 1/2" · 125 mm                           |
| 1/2" · 10-11-12-13-14-15-17-19-22-24 mm |



R.sz. leírás  
17229 8



8







**FESTA**

**DUGÓKULCS KLT.**

- 1/2" · 72 T
- 1/2" · 75, 125 mm
- 1/2"
- 1/2" · 10-11-12-13-14-15-16-17-18-19-22-24 mm
- 1/2" · 17mm, 19mm
- 3 way adapter
- 16mm, 21mm



R.s. leírás

17230



4

**FESTA**

**DUGÓKULCS KLT.**

- 1/4" · 72 T
- 1/4" · 50, 100 mm
- 1/4"
- 1/4" · 4-5-5,5-6-7-8-10-11-12-13 mm
- 1/4" · 6-7-8-10-12-13 mm
- 3 way adapter
- 4 x
- 11x
- 1x



R.s. leírás

17231



10

**FESTA**

**DUGÓKULCS KLT.**

- 1/4"
- 1/4"
- 1/4" · 4-4,5-5-5,5-6-7-8-9-10-11-12-13-14 mm
- 1/4" · 50 mm, 100 mm
- 1/4"
- 1/4"
- 21 x
- 1/4"
- L 1/4"



R.s. leírás

17233



10

**FESTA**

**DUGÓKULCS KLT.**

- 1/2", 1/4" · 72T
- 1/4"
- 16 mm, 21 mm
- 1/4" · 10-11-12-13-14-15-16-17-18-19-20-21-22-23-24-27 mm
- 1/4" · 100 mm
- 1/2" · 125 mm, 250 mm
- 1/4"
- 1 x
- 1/4" · 4-5-5,5-6-7-8-10-11-12-13 mm
- 33 x

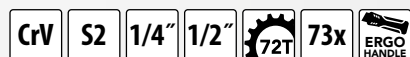

R.s. leírás

17234



4

**FESTA**

**DUGÓKULCS KLT.**

- 1/2", 1/4" · 72T
- 1/4"
- 16 mm, 21 mm
- 1/4" · 4 -4,5-5-5,5-6-7-8-9-10-11-12-13-14 mm
- 1/2" · 10-11-12-13-14-15-16-17-18-19-20-21-22-23-24-27-30-32 mm
- 1/4" · 6-7-8-9-10-11-12-13 mm
- 1/2" · 14-15-17-19 mm
- 1/4" · 50 mm, 100 mm
- 1/2" · 125 mm, 250 mm
- 1/4"
- 5/16" bit holder
- 7x
- 5x
- 3 way adapter
- 3 x
- 1/4"
- 1/4"
- 1/2", 1/4"

CrV S2 1/4" 1/2" 72T 94x ERGO HANDLE

R.s. leírás

17235



10 years guarantee



4

**FESTA**

**DUGÓKULCS KLT.**

- 1/2", 1/4" · 72T
- 150 mm
- 16 mm, 21 mm
- 1/4" · 4 -4,5-5-5,5-6-7-8-9-10-11-12-13-14 mm
- 1/2" · 10-11-12-13-14-15-16-17-18-19-20-21-22-24-27-30-32 mm
- 1/4" · 6-7-8-9-10-11-12-13 mm
- 1/2" · 14-15-17-19-22 mm
- 1/4" · 50 mm, 100 mm
- 1/2" · 125 mm, 250 mm
- E · 4-5-6-7-8-10-11-12-14-16-18-20-24-27-30-32 mm
- 1/2", 1/4"
- 5/16" bit holder
- 18 x
- 17 x
- 3 way adapter
- 4 x
- 1/4"
- L 1/4"

CrV S2 1/4" 1/2" 72T 110x ERGO HANDLE

R.s. leírás

17236



10 years guarantee



4

**FESTA**

**DUGÓKULCS KLT.**

- 1/2", 1/4", 3/8"
- 1/4" · 4-5-6-7-8-9-10mm
- 3/8" · 10-11-12-13-14-15mm
- 1/2" · 16-17-18-19-22mm
- 1/4" · 4-4,5-5-5,5-6-7-8-9-10-11-12-13-14mm
- 3/8" · 10-11-12-13-14-15-16-17-18-19mm
- 1/2" · 10-11-12-13-14-15-16-17-18-19-20-21-22-24-27-30-32mm
- 1/4" · E4-E5-E6-E7-E8
- 3/8" · E10-E11-E12-E14-E16-E18
- 1/2" · E20-E24
- 1/2" · 24x
- 1/4" · 20x
- 1/4" · 30x
- 1/4" · 50 mm, 100 mm
- 1/2" · 125 mm, 250 mm
- 3/8" · 150 mm
- 1/2" · 16-21mm
- 3/8" · 18mm
- 1/2", 1/4", 3/8" bit holder
- 1/2", 1/4", 3/8"
- 1/4" · 150mm
- 1/4" · 115mm
- Inbus 7X

CrV S2 1/4" 1/2" 3/8" 72T 171x ERGO HANDLE

R.s. leírás

17237



10 years guarantee



2

**FESTA®**



**FESTA RACSNIS HAJTÓSZÁR**

- a hajtószár a legjobb minőségű crv acélnól készül
- a 72 fogú racsni a precízebb munkát segíti elő
- minőségi ergonomikus két komponenses szoft gumi nyél
- gyors kioldó rendszer a dugófejek gyors és egyszerű cseréjéhez



**FESTA®**

**RACSNIS**



R.s.	leírás	délka	
17297	1/4"	155 mm	6
17298	3/8"	210 mm	5
17299	1/2"	255 mm	4

**FESTA®**

**RACSNIS**



R.s.	leírás	délka	
17240	1/4"	155 mm	10
17241	3/8"	200 mm	10
17242	1/2"	250 mm	5



**FESTA®**

**RACSNIS**



R.s.	leírás	délka	
17294	1/4"	155 mm	6
17295	3/8"	205 mm	10
17296	1/2"	255 mm	4

**FESTA®**

**RACSNIS 1/4"**



R.s.	leírás	
17292	1/4"	1



**RACSNIS**



R.s.	leírás	
17243	1/4"	25
17244	1/2"	25

**FESTA®**

**ADAPTER DUGÓKULCSOKHOZ**

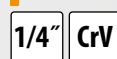

R.s.	leírás	
18603	1/4" 150 mm	10

**NEW**



**DUGÓKULCS FEJ UNIVERZÁLIS**



R.sz.	leírás	
17812	10 - 19 mm	1



**DUGÓKULCS FEJ UNIVERZÁLIS**



R.sz.	leírás	
17810	7 - 19mm • 52mm x ø26mm	1



**DUGÓKULCS FEJ UNIVERZÁLIS**



R.sz.	leírás	
17811	11 - 32mm • 83mm x ø43mm	5

**FESTA**

**DUGÓKULCS FEJ 1/4'**



R.sz.	leírás		R.sz.	leírás	
17860	4 mm • 50 mm	10	17866	10 mm • 50 mm	10
17861	5 mm • 50 mm	10	17867	11 mm • 50 mm	10
17862	6 mm • 50 mm	10	17868	12 mm • 50 mm	10
17863	7 mm • 50 mm	10	17869	13 mm • 50 mm	10
17864	8 mm • 50 mm	10	17870	14 mm • 50 mm	10
17865	9 mm • 50 mm	10			



**FESTA**

**DUGÓKULCS FEJ 1/4'**



R.sz.	leírás		R.sz.	leírás	
17820	4 mm • 25 mm	10	17827	9 mm • 25 mm	10
17821	4,5 mm • 25 mm	10	17828	10 mm • 25 mm	10
17822	5 mm • 25 mm	10	17829	11 mm • 25 mm	10
17823	5,5 mm • 25 mm	10	17830	12 mm • 25 mm	10
17824	6 mm • 25 mm	10	17831	13 mm • 25 mm	10
17825	7 mm • 25 mm	10	17832	14 mm • 25 mm	10
17826	8 mm • 25 mm	10			



**FESTA**

**DUGÓKULCS FEJ 1/2'**



R.sz.	leírás		R.sz.	leírás	
17871	10 mm • 70 mm	10	17882	21 mm • 70 mm	10
17872	11 mm • 70 mm	10	17883	22 mm • 70 mm	10
17873	12 mm • 70 mm	10	17884	23 mm • 70 mm	10
17874	13mm • 70 mm	10	17885	24 mm • 70 mm	10
17875	14 mm • 70 mm	10	17886	25 mm • 70 mm	10
17876	15 mm • 70 mm	10	17887	26 mm • 70 mm	10
17877	16 mm • 70 mm	10	17888	27 mm • 70 mm	10
17878	17 mm • 70 mm	10	17889	28 mm • 70 mm	10
17879	18 mm • 70 mm	10	17890	30 mm • 70 mm	10
17880	19 mm • 70 mm	10	17891	32 mm • 70 mm	10
17881	20 mm • 70 mm	10	17892	34 mm • 70 mm	10



**FESTA**

**DUGÓKULCS FEJ 1/2'**



R.sz.	leírás		R.sz.	leírás	
17308	8 mm • 38 mm	10	17319	19 mm • 38 mm	10
17309	9 mm • 38 mm	10	17320	20 mm • 38 mm	10
17310	10 mm • 38 mm	10	17321	21 mm • 38 mm	10
17311	11 mm • 38 mm	10	17322	22 mm • 38 mm	10
17312	12 mm • 38 mm	10	17324	24 mm • 38 mm	10
17313	13 mm • 38 mm	10	17327	27 mm • 42 mm	20
17314	14 mm • 38 mm	10	17330	30 mm • 42 mm	25
17315	15 mm • 38 mm	10	17332	32 mm • 42 mm	20
17316	16 mm • 38 mm	10	17333	34 mm • 42 mm	20
17317	17 mm • 38 mm	10	17334	36 mm • 42 mm	20
17318	18 mm • 38 mm	10			





**FESTA**

DUGÓKULCS FEJ 3/4"

CrV  3/4"



R.sz.	leírás	
17835	17 mm · 48 mm	10
17836	18 mm · 48 mm	10
17837	19 mm · 48 mm	10
17838	21 mm · 48 mm	10
17839	22 mm · 48 mm	10
17840	24 mm · 48 mm	10
17841	26 mm · 48 mm	10
17842	27 mm · 52 mm	10
17843	28 mm · 52 mm	10
17844	30 mm · 52 mm	10
17845	32 mm · 52 mm	10

R.sz.	leírás	
17846	33 mm · 55 mm	10
17847	36 mm · 60 mm	10
17848	38 mm · 60 mm	10
17849	41 mm · 65 mm	10
17850	46 mm · 65 mm	10
17851	50 mm · 70 mm	10
17852	55 mm · 75 mm	10
17853	60 mm · 78 mm	10
17854	65 mm · 82 mm	10
17855	70 mm · 82 mm	10
17856	75 mm · 88 mm	10



**FESTA**

DUGÓKULCS FEJ MULTILOCK 1/4"

CrV  1/4"



R.sz.	leírás	
17895	4 mm · 25 mm	10
17896	4,5 mm · 25 mm	10
17897	5 mm · 25 mm	10
17898	5,5 mm · 25 mm	10

R.sz.	leírás	
17902	9 mm · 25 mm	10
17904	11 mm · 25 mm	10
17905	12 mm · 25 mm	10
17907	14 mm · 25 mm	10



**FESTA**

DUGÓKULCS FEJ MULTILOCK 1/2"

CrV  1/2"



R.sz.	leírás	
17910	8 mm · 38 mm	10
17912	10 mm · 38 mm	10
17913	11 mm · 38 mm	10
17914	12 mm · 38 mm	10
17916	14 mm · 38 mm	10

R.sz.	leírás	
17922	21 mm · 38 mm	10
17924	24 mm · 38 mm	10
17925	27 mm · 38 mm	10
17926	30 mm · 38 mm	10
17927	32 mm · 38 mm	10





**FESTA**

DUGÓKULCS FEJ TORX 1/4"

CrV  1/4"



R.sz.	leírás	
17930	E4	10
17931	E5	10
17932	E6	10

R.sz.	leírás	
17933	E7	10
17934	E8	10
17935	E10	10



**FESTA**

DUGÓKULCS FEJ TORX 1/2"

CrV  1/2"



R.sz.	leírás	
17943	E22	10
17944	E24	10



**FESTA**

CSAVARHÚZÓ FEJ 1/4"

CrV S2 — 1/4"



R.sz.	leírás	
18920	S 4 mm	10
18921	S 5,5 mm	10
18922	S 7 mm	10



**FESTA**

CSAVARHÚZÓ FEJ 1/4"

CrV S2 + 1/4"



R.sz.	leírás	
18925	PH 1	10
18926	PH 2	10
18927	PH 3	10



**FESTA**

CSAVARHÚZÓ FEJ 1/4"

CrV S2 \* 1/4"



R.sz.	leírás	
18928	PZ 0	10
18929	PZ 1	10
18930	PZ 2	10
18931	PZ 3	10



**FESTA**

CSAVARHÚZÓ FEJ 1/2"

CrV S2 1/2"



R.sz.	leírás	
18971	M 16	10



**FESTA**

CSAVARHÚZÓ FEJ 1/4"

CrV S2 1/4"



R.sz.	leírás	
18934	3 mm	10
18937	6 mm	10
18939	8 mm	10



**FESTA**

CSAVARHÚZÓ FEJ 1/2"

CrV S2 1/2"



R.sz.	leírás	
18944	12 mm	10
18945	14 mm	10



**FESTA**

CSAVARHÚZÓ FEJ 1/4"

CrV S2 \* 1/4"



R.sz.	leírás	
18948	T 5	10
18950	T 8	10
18951	T 10	10



**FESTA**

CSAVARHÚZÓ FEJ 1/2"

CrV S2 \* 1/2"



R.sz.	leírás		R.sz.	leírás	
18954	T 10	10	18960	T 40	10
18955	T 15	10	18961	T 45	10
18956	T 20	10	18963	T 55	10
18957	T 25	10			

**FESTA**  
 ADAPTER

CrV

R.sz.	leírás	
17410	A - 1/4" B - 3/8"	10
17411	A - 3/8" B - 1/4"	10
17412	A - 3/8" B - 1/2"	10
17413	A - 1/2" B - 3/8"	10

**FESTA**  
 HAJTÓKAR ADAPTER

CrV

R.sz.	leírás	
17420	1/4"	1
17421	1/2"	1
17422	3/4"	1

**FESTA**  
 „T” HAJTÓKAR

CrV

R.sz.	leírás	
17382	1/4" · 115 mm	1
17383	3/8" · 190 mm	1
17384	1/2" · 250 mm	1
17385	3/4" · 460 mm	1
17386	1" · 640 mm	1

**FESTA**  
 HAJTÓKAR, CSUKLÓS

CrV

R.sz.	leírás	
17380	1/2" · 350 mm	1
17381	3/4" · 500 mm	1

**FESTA**  
 KARDÁN CSUKLÓ

CrV

R.sz.	leírás	
17405	1/4" · 39 mm	10
17406	1/2" · 71 mm	10
17407	3/4" · 105 mm	10

**FESTA**  
 T KULCS

CrV

R.sz.	leírás	
17401	1/4" · 250 mm	1
17402	1/2" · 400 mm	1

**FESTA**  
 HAJTÓKAR 90°-OS

CrV 1/2"

R.sz.	leírás	
17427	1/2" · 60 x 320 mm	1





**FESTA**

HOSSZABBÍTÓ SZÁR

CrV

R.sz.	leírás	
17390	1/4" · 50 mm	1
17391	1/4" · 100 mm	1
17392	1/4" · 150 mm	1
17393	1/2" · 75 mm	1
17394	1/2" · 125 mm	1



**FESTA**

RUGÓS HOSSZABBÍTÓ

CrV 1/4"

R.sz.	leírás	
17400	1/4" · 150 mm	1



**Stahlberg**

BIT ADAPTER RACSNIRA 1/4"

CrV

1/4" ↔ 1/4"



R.sz.	leírás	
18619		5



FÚRÓ ADAPTER KÉSZLET

CrV 1/4" 3x

R.sz.	leírás	
18604	1/4", 3/8", 1/2"	10



KÉZI LÉGTELENÍTŐ KULCS TARTÁLYOS



R.sz.	leírás	
17459	50 ml	1

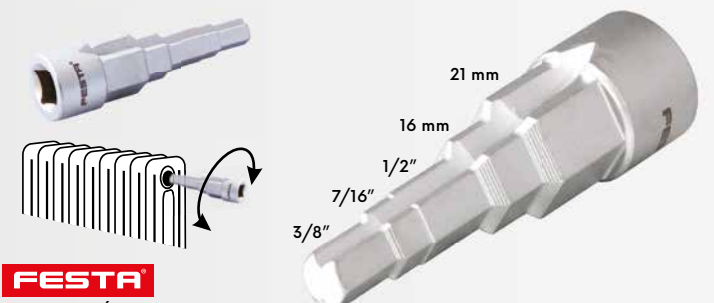

**FESTA**

RADIÁTORKULCS

CrV 1/2"

R.sz.	leírás	
17455	pro ráőnu 1/2"	10



**FESTA**

UNIVERZÁLIS KULCS AZ ELOSZTOSZEKRÉNYEKHEZ

1,0 x 7 mm  
 PH2



R.sz.	leírás	
17458		1



**FESTA**

UNIVERZÁLIS KULCS AZ ELOSZTOSZEKRÉNYEKHEZ

D 11-12 A 7-8 A 6-7 D 3-5  
 C 8-9 D C 9-10 B 6-9  
 1,0 x 7 mm  
 PH2



R.sz.	leírás	
17456		50





# FESTA®

- Kiváló minőségű CRV acélból készült kovácsolt kulcsok
- DIN szabványok szerint készítve
- Krómozott felületkezelés



## FESTA®

### VILLÁSKULCS

CrV DIN 3110



R.sz.	leírás	
17550	6 x 7 mm	10
17551	8 x 9 mm	10
17552	8 x 10 mm	10
17553	10 x 11 mm	10
17590	10 x 13 mm	10
17554	12 x 13 mm	10
17555	14 x 15 mm	10
17556	13 x 16 mm	10
17557	13 x 17 mm	10
17591	14 x 17 mm	10
17558	16 x 17 mm	10
17559	17 x 19 mm	10
17560	18 x 19 mm	10

R.sz.	leírás	
17592	19 x 22 mm	10
17593	19 x 24 mm	10
17561	20 x 22 mm	10
17569	21 x 23 mm	10
17548	22 x 24 mm	10
17562	24 x 27 mm	10
17549	24 x 30 mm	10
17563	30 x 32 mm	10
17564	30 x 34 mm	10
17565	32 x 36 mm	10
17566	36 x 41 mm	10
17567	46 x 50 mm	10
17568	50 x 55 mm	3

## FESTA®

### CSILLAG - VILLÁSKULCS

CrV DIN 3113



R.sz.	leírás	
17487	6 mm	10
17570	7 mm	10
17571	8 mm	10
17572	9 mm	10
17573	10 mm	10
17574	11 mm	10
17575	12 mm	10
17576	13 mm	10
17577	14 mm	10
17578	15 mm	10
17579	16 mm	10
17580	17 mm	10
17581	18 mm	10
17582	19 mm	10
17488	20 mm	10

R.sz.	leírás	
17489	21 mm	10
17583	22 mm	10
17490	23 mm	10
17584	24 mm	10
17491	25 mm	10
17492	26 mm	10
17585	27 mm	10
17493	28 mm	10
17494	29 mm	10
17586	30 mm	10
17587	32 mm	10
17495	33 mm	10
17496	34 mm	10
17589	36 mm	10



## FESTA®

### RACSNIS KULCS, CSUKLÓS

CrV 72T



R.sz.	leírás	
17628	8 mm	10
17622	10 mm	10
17623	13 mm	10
17624	14 mm	10
17629	15 mm	10
17630	16 mm	5

R.sz.	leírás	
17625	17 mm	10
17631	18 mm	10
17626	19 mm	10
17632	21 mm	5
17633	22 mm	5

## FESTA®

### RACSNIS KULCS

CrV 72T



R.sz.	leírás	
17660	6 mm	10
17676	7 mm	10
17661	8 mm	10
17662	9 mm	10
17663	10 mm	10
17664	11 mm	10
17665	12 mm	10
17666	13 mm	10
17667	14 mm	10
17668	15 mm	10

R.sz.	leírás	
17669	16 mm	10
17670	17 mm	10
17671	18 mm	10
17672	19 mm	10
17674	21 mm	5
17675	22 mm	5
17677	24 mm	5
17678	27 mm	5
17679	30 mm	5
17683	32 mm	5



**FESTA**

CSILLAGKULCS HAJLÍTOTT

**CrV** **DIN 838**



R.sz.	leírás	
17605	6 x 7 mm	10
17606	8 x 9 mm	10
17607	8 x 10 mm	10
17608	10 x 11 mm	10
17609	12 x 13 mm	10
17611	13 x 16 mm	10
17612	13 x 17 mm	10

R.sz.	leírás	
17610	14 x 15 mm	10
17613	16 x 17 mm	10
17614	18 x 19 mm	10
17615	20 x 22 mm	10
17616	24 x 27 mm	10
17617	30 x 32 mm	10

**FESTA**

VILLÁSKULCS

**DIN 895**



R.sz.	leírás	
17460	6 x 7 mm	10
17461	8 x 9 mm	10
17462	8 x 10 mm	10
17463	10 x 11 mm	10
17481	10 x 13 mm	10
17464	12 x 13 mm	10
17465	14 x 15 mm	10
17466	13 x 16 mm	10
17467	13 x 17 mm	10
17482	14 x 17 mm	10
17468	16 x 17 mm	10

R.sz.	leírás	
17469	17 x 19 mm	10
17470	18 x 19 mm	10
17483	19 x 22 mm	10
17484	19 x 24 mm	10
17471	20 x 22 mm	10
17472	24 x 27 mm	10
17486	21 x 23 mm	10
17480	28 x 30 mm	10
17473	30 x 32 mm	10
17485	36 x 41 mm	10



**FESTA**

VILLÁSKULCS

**CrV** **DIN 3110**



R.sz.	leírás	
17761	14 x 15 mm	10
17769	20 x 22 mm	10

**FESTA**

CSILLAG - VILLÁSKULCS

**CrV** **DIN 3113**



R.sz.	leírás	
17788	14 mm	10
17789	15 mm	10

R.sz.	leírás	
17795	21 mm	10
17806	33 mm	10



KULCS

**Cr-Mo**



R.sz.	leírás	
17685	12-13-14-15-16-17-18-19 mm	1



**FESTA**

ÁLLÍTHATÓ VILLÁSKULCS

**CrV**



R.sz.	rozsah	délka	
17197	0 - 29 mm	200 mm	1
17198	0 - 33 mm	250 mm	1
17199	0 - 38 mm	300 mm	1

ÁLLÍTHATÓ VILLÁSKULCS

R.sz.	rozsah	délka	
17200	0 - 24 mm	200 mm	6
17201	0 - 30 mm	250 mm	6
17202	0 - 34 mm	300 mm	6

**FESTA**

VILLÁSKULCS KLT.

**CrV****DIN 3110**

R.sz.	leírás	
17506	6 db · 6 x 7, 8 x 9, 10 x 11, 12 x 13, 14 x 15, 16 x 17	1
17508	8 db · 6 x 7, 8 x 9, 10 x 11, 12 x 13, 14 x 15, 16 x 17, 18 x 19, 20 x 22	1

**FESTA**

CSILLAG-VILLÁSKULCS KLT.

**CrV****DIN 3113**

R.sz.	leírás	
17526	6 db · 10 x 10, 11 x 11, 13 x 13, 14 x 14, 16 x 16, 17 x 17	1
17528	8 db · 8 x 8, 10 x 10, 11 x 11, 13 x 13, 14 x 14, 16 x 16, 17 x 17, 19 x 19	1

**FESTA**

CSILLAGKULCS KLT.

**CrV****DIN 838****8x**

R.sz.	leírás	
17539	6 x 7, 8 x 9, 10 x 11, 12 x 13, 14 x 15, 16 x 17, 18 x 19, 20 x 22	1

**FESTA**

VILLÁSKULCS KLT.

**CrV****DIN 3110****12x**

R.sz.	leírás	
17512	6 x 7, 8 x 9, 10 x 11, 12 x 13, 14 x 15, 16 x 17, 18 x 19, 20 x 22, 21 x 23, 24 x 27, 25 x 28, 30 x 32	1

**FESTA**

CSILLAG-VILLÁSKULCS KLT.

**CrV****DIN 3113**

R.sz.	leírás	
17532	12 db · 8 x 8, 9 x 9, 10 x 10, 11 x 11, 13 x 13, 14 x 14, 16 x 16, 17 x 17, 18 x 18, 19 x 19, 21 x 21, 22 x 22	10
17533	18 db · 6 x 6, 7 x 7, 8 x 8, 9 x 9, 10 x 10, 11 x 11, 12 x 12, 13 x 13, 14 x 14, 15 x 15, 16 x 16, 17 x 17, 18 x 18, 19 x 19, 20 x 20, 21 x 21, 22 x 22, 24 x 24	1
17534	25 db · 6 x 6, 7 x 7, 8 x 8, 9 x 9, 10 x 10, 11 x 11, 12 x 12, 13 x 13, 14 x 14, 15 x 15, 16 x 16, 17 x 17, 18 x 18, 19 x 19, 20 x 20, 21 x 21, 22 x 22, 23 x 23, 24 x 24, 25 x 25, 26 x 26, 27 x 27, 28 x 28, 30 x 30, 32 x 32	4

**FESTA**

VILLÁSKULCS KLT.

**DIN 895**

R.sz.	leírás	
17475	8 db · 6 x 7, 8 x 9, 10 x 11, 12 x 13, 14 x 15, 16 x 17, 18 x 19, 20 x 22	5
17476	12 db · 6 x 7, 8 x 9, 10 x 11, 12 x 13, 14 x 15, 16 x 17, 18 x 19, 20 x 22, 21 x 23, 24 x 27, 28 x 30, 30 x 32	3



**FESTA**

RACSNIS KULCS KÉSZLET

CrV 72T 7x

R.sz.	leírás	
17620	8, 10, 12, 13, 14, 17, 19	5



**FESTA**

RACSNIS KULCS, CSUKLÓS, KÉSZLET

CrV 72T 7x

R.sz.	leírás	
17621	10, 12, 13, 14, 15, 17, 19	5



**FESTA**

CSŐKULCS KLT.

CrV 7x

R.sz.	leírás	
17501	6 x 7, 8 x 9, 10 x 11, 12 x 13, 14 x 15, 16 x 17, 18 x 19	20
17640	páka na trubkové klíče · 135 mm	50



**FESTA**

UNIVERZÁLIS KULCS

CrV

R.sz.	leírás	
17680	19 - 51 mm 165 mm	5
17681	32 - 76 mm 216 mm	5
17682	51 - 121 mm 267 mm	5



**FESTA**

CSŐKULCS

CrV

R.sz.	leírás		R.sz.	leírás	
17650	6 x 7 mm	10	17655	16 x 17 mm	10
17651	8 x 9 mm	10	17645	16 x 18 mm	10
17642	8 x 10 mm	10	17653	16 x 21 mm	10
17652	10 x 11 mm	10	17656	18 x 19 mm	10
17643	12 x 13 mm	10	17657	19 x 22 mm	10
17654	14 x 15 mm	10	17659	22 x 24 mm	10
17644	14 x 17 mm	10	17658	24 x 27 mm	10



KÖRMÖSKULCS

R.sz.	leírás	
20967	200 mm	15



KÖRMÖSKULCS

R.sz.	leírás	
20968	200 mm	1



**FESTA**

## NYOMATÉK KULCS

R.sz.	leírás		
17203	1/4"	5 - 25 Nm	1
17204	1/2"	19 - 110 Nm	1
17205	1/2"	42 - 210 Nm	1
17206	3/4"	140 - 700 Nm	1

**FESTA**

## RACSNIS HAJTÓKAR

R.sz.	leírás		
17451	18 mm		10
17450	19 mm		10

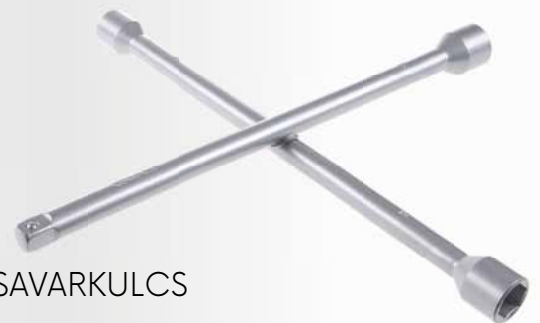

## KERÉK CSAVARKULCS



R.sz.	leírás		
17600	17, 19, 22 mm, 13/16"		16

## KERÉK CSAVARKULCS



R.sz.	leírás		
17601	17, 19, 21 mm		20



## KERÉKKULCS, TELESZKÓPOS



1/2"

3x

R.sz.	leírás		
17603	17 x 19 mm, 21 x 23 mm		20



## GYERTYAKULCS



R.sz.	leírás		
17261	16 mm		1
17262	21 mm		1



**FESTA**

MÁGNESES SZERSZÁMTARTÓ



R.sz. leírás

70098



12



**FESTA**

MÁGNESES FELSZEDŐ TELESZKÓPOS - LED



R.sz. leírás

13294



6

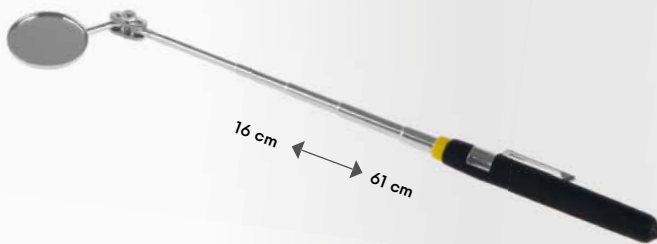

VIZSGÁLÓ TÜKÖR



R.sz. leírás

13290



20

R.sz. leírás

13293



20

MÁGNESES FELSZEDŐ TELESZKÓPOS

**FESTA®**

- Minőségi S2 acélból készült
- Mágneses végződés
- Ergonomikus kétkomponensű fogantyú lágyított TPE gumival

**FESTA®**

## CSAVARHÚZÓ LAPOS



R.sz.	leírás	
18113	3 x 75 mm	12
18114	4 x 100 mm	12
18115	5,5 x 125 mm	12
18116	6,5 x 150 mm	12
18118	8 x 175 mm	6
18120	10 x 200 mm	6

**FESTA®**

## CSAVARHÚZÓ LAPOS RÖVID

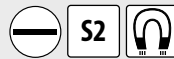

R.sz.	leírás	
18124	5,5 x 38 mm	12
18125	6,5 x 38 mm	12

**FESTA®**

## CSAVARHÚZÓ PHILIPS



R.sz.	leírás	
18210	0 x 75 mm	12
18211	1 x 75 mm	12
18212	2 x 100 mm	12

**FESTA®**

## CSAVARHÚZÓ PHILIPS RÖVID

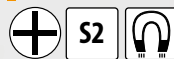

R.sz.	leírás	
18215	1 x 38 mm	12
18216	2 x 38 mm	12

**FESTA®**

## CSAVARHÚZÓ POZIDRIVE



R.sz.	leírás	
18310	0 x 75 mm	12
18311	1 x 100 mm	12
18312	2 x 100 mm	12
18313	3 x 150 mm	6

**FESTA®**

## CSAVARHÚZÓ POZIDRIVE RÖVID

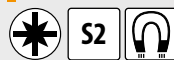

R.sz.	leírás	
18321	1 x 38 mm	12
18322	2 x 38 mm	12

**FESTA**

## CSAVARHÚZÓ TORX



R.sz.	leírás	
18350	T6	12
18351	T7	12
18352	T8	12
18353	T9	12
18354	T10	12
18355	T15	12

R.sz.	leírás	
18356	T20	12
18357	T25	12
18358	T27	12
18359	T30	12
18360	T40	6

**FESTA**

## CSAVARBEHÚZÓ CSAVARHÚZÓ



R.sz.	leírás	
18455	6 mm	12
18456	7 mm	12
18460	13 mm	12

**FESTA**

## CSAVARHÚZÓ ÜTHETŐ LAPOS



R.sz.	leírás	
18062	5,5 x 100 mm	12
18063	7 x 125 mm	6
18064	8 x 150 mm	8

R.sz.	leírás	
18065	10 x 175 mm	6
18066	10 x 200 mm	6
18067	10 x 250 mm	6

**FESTA**

## CSAVARHÚZÓ ÜTHETŐ PHILIPS



R.sz.	leírás	
18070	PH 1 x 80 mm	8
18071	PH 2 x 100 mm	12
18072	PH 3 x 150 mm	6

**FESTA**

## CSAVARHÚZÓ ÜTHETŐ POZIDRIVE



R.sz.	leírás	
18075	PZ 1 x 80 mm	12
18076	PZ 2 x 100 mm	12
18077	PZ 3 x 150 mm	6

**FESTA**

## VDE CSAVARHÚZÓ SZIGETELT LAPOS



R.sz.	leírás	
18088	3 x 75 mm S2	12
18089	4 x 100 mm CrV	12
18090	5,5 x 125 mm CrV	12
18091	6,5 x 150 mm CrV	12
18092	8 x 175 mm CrV	12

**FESTA**

## VDE CSAVARHÚZÓ SZIGETELT PHILIPS



R.sz.	leírás	
18080	PH 0 x 60 mm S2	12
18081	PH 1 x 80 mm CrV	12
18082	PH 2 x 100 mm CrV	12
18083	PH 3 x 150 mm CrV	12

**FESTA**

## VDE CSAVARHÚZÓ SZIGETELT POZIDRIVE



R.sz.	leírás	
18084	PZ 0 x 60 mm S2	12
18085	PZ 1 x 80 mm CrV	12
18086	PZ 2 x 100 mm CrV	12
18087	PZ 3 x 150 mm CrV	12





**FESTA**

**CSAVARHÚZÓ KÉSZLET**

⊖ S 3x75 · 5x100 · 6x175mm

⊕ PH 0 · 1 · 2 · 3



R.sz. leírás  
**18402**

6



**FESTA**

**CSAVARHÚZÓ KÉSZLET**

⊖ S 3 x 75 · 4x100 · 5,5x125 · 6,5 x 150mm

⊕ PH 1 x 100 · 2 x 100mm

○ adapter 1/4"

bits: ⊖ S 4 · 5 · 6 · 7

⊕ PH 1 · 2 · 3

⊛ PZ 1 · 2 · 3

⊛ T 10 · 15 · 20 · 25 · 30

● H 2 · 3 · 4 · 5 · 6



R.sz. leírás  
**18422** 27 db

6



**FESTA**

**CSAVARHÚZÓ KÉSZLET**

⊖ S 3x75 · 5x100 · 6x150mm

⊕ PH 0 · 1 · 2



R.sz. leírás  
**18403**

6



**FESTA**

**CSAVARHÚZÓ KÉSZLET**

⊖ S 3x60 · 6x100 · 6x125mm

⊛ PZ 0 · 1 · 2



R.sz. leírás  
**18404**

6



**FESTA**

**CSAVARHÚZÓ KÉSZLET**

⊖ S 6x38 · 5x75 · 6x100 · 8x150mm  
2,5x50 · S 3x50mm

⊕ PH 2x38 · 1x75 · 2x100 · 3x150mm  
0x50 · 00x50mm

⊛ T 5x50 · 6x50 · 7x50 · 8x50 · 9x50 · 10x50mm



R.sz. leírás  
**18424**

6



**FESTA**

**CSAVARHÚZÓ KÉSZLET TORX**

⊛ T 10 · 15 · 20 · 25 · 30



R.sz. leírás  
**18340**

6



**FESTA**

**CSAVARHÚZÓ KÉSZLET**

⊖ S 5 · 6 · 8 mm

⊕ PH 1 · 2 · 3

**CrV** **6x**



R.s. leírás  
**18423**

10



**FESTA**

**SZIGETELT CSAVARHÚZÓ KLT.**

⊖ S 4x100 · 5,5x125 mm · fáziskereső 0 - 250 V

⊕ PH 0x60 · 1x80 · 2x100 mm

⊖ ⊕ **6x** 1000 V   
IEC/EN60900

R.s. leírás  
**18413**

6



**FESTA**

**CSAVARHÚZÓ ÜTHETŐ**

⊖ S 7 x 35 · 8 x 35 · 8 x 70 mm

⊕ PH 2 x 35 · 3 x 35 · 3 x 70 mm

**CrV** **6x**



R.s. leírás  
**18411**

1



**FESTA**

**SZIGETELT CSAVARHÚZÓ KLT.**

⊖ S 4x100 · 5,5x125 · 6,5x150 mm · fáziskereső 0 - 250 V

⊕ PH 0x75 · 1x100 · 2x100 mm

⊖ ⊕ **7x** 1000 V   
IEC/EN60900:2004

R.s. leírás  
**18410**

40



**FESTA**

**SÖRNYITÓ**

R.s. leírás  
**18437**



5



**FÁZISKERESŐ**

DIN VDE 0680  
73/23 EEC

⊖

R.s. leírás  
**18426** 0 - 250 V



1



CSAVARHÚZÓ LAPOS



R.sz.	leírás	
18101	4 x 75 mm	10
18102	4 x 100 mm	10
18103	5,5 x 100 mm	10
18104	5,5 x 125 mm	10
18105	6,5 x 100 mm	10
18106	6,5 x 125 mm	10
18107	8 x 160 mm	10
18108	10 x 160 mm	10



CSAVARHÚZÓ KÉSZLET BITEKSEL

- S 3x75 · 4x75 · 6x100 · 8x150 mm
- PH 1x75 · 2x100 mm
- adapter 1/4"

- bits:
- S 4 · 5 · 6 · 7 mm
  - PH 1 · 2 · 3
  - PZ 1 · 2 · 3
  - T 10 · 15 · 20
  - adapter



R.sz.	leírás	
18418		10



CSAVARHÚZÓ PHILIPS



R.sz.	leírás	
18201	0 x 75 mm	10
18202	1 x 75 mm	10
18203	2 x 100 mm	10
18204	3 x 150 mm	10



CSAVARHÚZÓ KÉSZLET

- S 3x60 · 4x75 · 6x100 · 6x125 mm
- PH 0x60 · 1x75 · 2x100 mm



R.sz.	leírás	
18400		10



CSAVARHÚZÓ POZIDRIVE



R.sz.	leírás	
18301	0 x 75 mm	10
18302	1 x 75 mm	10
18303	2 x 100 mm	10
18304	3 x 150 mm	10



CSAVARHÚZÓ KÉSZLET

- S 3x60 · 6x100 · 6x125 mm
- PH 1x75 · 2x100 mm



R.sz.	leírás	
18401		1



**FESTA**

MÁGNESES T BITCSAVARHÚZÓ

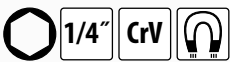

R.s. leírás



18608

6



**FESTA**

RACSNIS CSAVARHÚZÓ

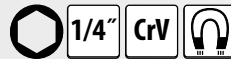

R.s. leírás



18433

6



**FESTA**

MÁGNESES BITCSAVARHÚZÓ



R.s. leírás



18110

12



**FESTA**

FLEXI CSAVARHÚZÓ BITHEZ



R.s. leírás



18451

12



**FESTA**

CSAVARHÚZÓ + 7 BIT

⊖ S5 · 6 mm

⊕ PH1 · 2 · 3

★ T15 · 20

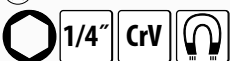

R.s. leírás



18425

10

**FESTA**

FLEXI CSAVARHÚZÓ TÖMLŐBILINCSHEZ



R.s. leírás



18450

7 mm

6





**FESTA**

**CSAVARHÚZÓ + BIT**

1/4"  $\leftrightarrow$  1/4"

- S 3 · 4 · 5 · 6 · 7 · 5 L
- PH 1 · 2 · 3 · 1 L · 2 L
- PZ 1 · 2 · 3 · 1 L · 2 L
- H 2 · 2.5 · 3 · 4 · 5 · 6
- T 10 · 15 · 20 · 25 · 27 · 30
- SQ 0 · 1 · 2 · 3
- 1/4" 5 · 6 · 7 · 8 · 9 · 10 · 11 · 12 · 13 mm

1/4" **45x**



R.s. leírás  
**18419**

6



**FESTA**

**MŰSZERÉSZ CSAVARHÚZÓK**

- S 1,5x50 · 2x50 · 2,5x50 mm
- PH 000x50 · 00x50 · 0x50 mm

**6x**



R.s. leírás  
**18416**

6



**FESTA**

**MŰSZERÉSZ CSAVARHÚZÓK**

- S 2,4 · 3,0 mm
- PH 0 · 1
- T 6 · 8

**6x**



R.s. leírás  
**18415**

10



**FESTA**

**T CSAVARHÚZÓ KLT. + 20 BIT**

- S 3 · 4 · 5 · 6 · 8 mm
- PH 0 · 1 · 2 · 3
- adapter + 5 · 6 · 7 · 8 · 9 · 10 · 11 · 12 · 13 mm

1/4" **20x**



R.s. leírás  
**18420**

5



**FESTA**

**MŰSZERÉSZ CSAVARHÚZÓK TORX**

- T 4 · 5 · 6 · 7 · 8 · 9 · 10x50 mm

**7x**



R.s. leírás  
**18417**

6



**FESTA**

**FINOM BITEK ADAPTEREKSEL**

- S 1.5 · 2 · 2.5 · 3 · 3.5 mm
- PH 000 · 00 · 0 · 1
- PZ 0 · 1
- T 5 · 6 · 7 · 8 · 9 · 10 · 15 · 20
- H 0.9 · 1.3 · 2.0 · 2.5 · 3.0 · 4.0

**50x**



R.s. leírás  
**18431**

6



ÓRÁS CSAVARHÚZÓ KLT.

⊖ S 1,4 · 2,0 · 2,4 · 3,0 mm

⊕ PH 0 · 1

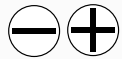

**6x** **HOBBY**



R.s. leírás  
**18408**

**10**

ÓRÁS CSAVARHÚZÓ KLT.

⊖ S 1,0 · 1,2 · 1,4 · 1,8 · 2,4 · 3,0 mm

⊕ PH 00 · 0 · 1

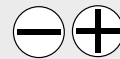

**11x** **HOBBY**



R.s. leírás  
**18409**

**48**



BIT ADAPTER 90°

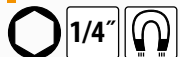

R.s. leírás  
**18910**



**25**



RACSNI BITEKHEZ



R.s. leírás  
**18435** 93 mm



**1**

# **Stahlberg**



# Stahlberg

Biték - professzionális csavarhúzó toldatok a legjobb minőségű CrV S2 anyagból

## STAHLBERG gyártócég

világmárka a csavarhúzó toldatokat gyártók között, sok éves tapasztalatokkal és vásárlókkal az egész világon. A gyártásnál felhasználja a legújabb technológiákat és az eddig legjobb kifejlesztésű anyagokat és felületi megmunkálásokat

## Gyártás technológiája

Kereszt és lapos csavarhúzó toldatok speciális technológiával vannak gyártva pontos kovácsolással. Amely lehetővé teszi a forma magas pontosságát és egyúttal magasabb szilárdságot is a bit megmunkálással szemben 20%-kal. A biték kovácsolás után az optimális keménység és szívósság elérésére edzve vannak. Rozsdamentesség elérése érdekében. További homok fúvással vannak kezelve



## TiN réteg

Kétszeres felvitele a csavarhúzóhegyére maximálisan emeli a felület keménységét, ütésállóságát és. A surlódási tulajdonságot, mely meggátolja a befogásból való kicsúszást. TiN réteg korrózióálló is.



## Gyémántszemcsék

A hegy felületén szósz szerint „beleharapnak” a csap vagy csavar fejébe és megtartja a bitet a maximális becsavarási pillanatig. A legjobb biztosíték a befogásban maradáshoz. A csavaros biték leggyakrabban a befogásból történő kicsúszáskor sérülnek meg. A csavaró pillanat most átvivődik a minimális felületre, amelyik deformálódik.

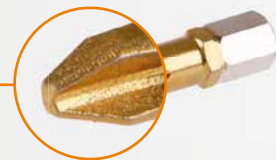

## Csúszásgátló vágások

A csavarhegyek kovácsolással készült munkafelületén további nagyon hatásos védelem a befogásból történő kicsúszás ellen.



**NEW**

Stahlberg  
BIT PH



S2

2x



R.sz.	leírás	
18632A	PH2 x 25 mm	1
18633A	PH3 x 25 mm	1

**NEW**

Stahlberg  
BIT PZ



S2

2x



R.sz.	leírás	
18636A	PZ1 x 25 mm	1
18637A	PZ2 x 25 mm	1
18638A	PZ3 x 25 mm	1

**NEW**

Stahlberg  
BIT T



S2

2x



R.sz.	leírás	
18827A	T20 x 25 mm	1
18828A	T25 x 25 mm	1
18830A	T30 x 25 mm	1
18831A	T40 x 25 mm	1





**Stahlberg**

**BIT PH GYÉMÁNTOK**



DIN 3128



MOQ 5



R.sz.	leírás	MOQ
18770	PH1 x 25 mm	5
18771	PH2 x 25 mm	5
18772	PH3 x 25 mm	5

**Stahlberg**

**BIT PZ GYÉMÁNTOK**



DIN 3128



MOQ 5



R.sz.	leírás	MOQ
18775	PZ1 x 25 mm	5
18776	PZ2 x 25 mm	5
18777	PZ3 x 25 mm	5

**Stahlberg**

**BIT S**



S2



MOQ 5



R.sz.	leírás	MOQ
18620	S 3 x 25 mm	5
18621	S 4 x 25 mm	5
18623	S 5 x 25 mm	5
18625	S 6 x 25 mm	5
18627	S 7 x 25 mm	5
18628	S 8 x 25 mm	5

**Stahlberg**

**BIT PH**



S2



MOQ 5



R.sz.	leírás	MOQ
18630	PH0 x 25 mm	5
18631	PH1 x 25 mm	5
18632	PH2 x 25 mm	5
18633	PH3 x 25 mm	5
18634	PH4 x 25 mm	5

**Stahlberg**

**BIT PZ**



S2



MOQ 5



R.sz.	leírás	MOQ
18635	PZ0 x 25 mm	5
18636	PZ1 x 25 mm	5
18637	PZ2 x 25 mm	5
18638	PZ3 x 25 mm	5
18639	PZ4 x 25 mm	5

**Stahlberg**

**BIT PH**



S2



MOQ 25



R.sz.	leírás	MOQ
18685	PH2 x 25 mm	25

**Stahlberg**

**BIT PZ**



S2



MOQ 25



R.sz.	leírás	MOQ
18680	PZ2 x 25 mm	25

**Stahlberg**

**BIT PH**



S2



MOQ 10



R.sz.	leírás	MOQ
18640	PH1 x 70 mm	10
18641	PH2 x 70 mm	10

**Stahlberg**

**BIT PZ**



S2



MOQ 10



R.sz.	leírás	MOQ
18645	PZ1 x 70 mm	10
18646	PZ2 x 70 mm	10

**Stahlberg**

**BIT PH**



S2 TiN



MOQ 5



R.sz.	leírás	MOQ
18760	PH0 x 25 mm	5
18761	PH1 x 25 mm	5
18762	PH2 x 25 mm	5
18763	PH3 x 25 mm	5
18764	PH4 x 25 mm	1

**Stahlberg**

**BIT PZ**



S2 TiN



MOQ 5



R.sz.	leírás	MOQ
18765	PZ0 x 25 mm	5
18766	PZ1 x 25 mm	5
18767	PZ2 x 25 mm	5
18768	PZ3 x 25 mm	5
18769	PZ4 x 25 mm	5

**Stahlberg**

**BIT S**



S2 TiN



MOQ 5



R.sz.	leírás	MOQ
18750	S 3 x 25 mm	5
18751	S 4 x 25 mm	5
18753	S 5 x 25 mm	5
18755	S 6 x 25 mm	5

## Stahlberg

### BIT H



S2



MOQ 5

R.sz.	leírás	
18800	H 1,5 x 25 mm	5
18801	H 2,0 x 25 mm	5
18802	H 2,5 x 25 mm	5
18803	H 3,0 x 25 mm	5
18804	H 4,0 x 25 mm	5
18805	H 5,0 x 25 mm	5
18806	H 5,5 x 25 mm	5
18807	H 6,0 x 25 mm	5

## Stahlberg

### BIT TTA



S2



MOQ 5

R.sz.	leírás	
18835	TTa 5 x 25 mm	10
18836	TTa 6 x 25 mm	5
18837	TTa 7 x 25 mm	5
18838	TTa 8 x 25 mm	5
18839	TTa 9 x 25 mm	5
18840	TTa 10 x 25 mm	5
18841	TTa 15 x 25 mm	5
18842	TTa 20 x 25 mm	5
18843	TTa 25 x 25 mm	5
18844	TTa 27 x 25 mm	5
18845	TTa 30 x 25 mm	5
18846	TTa 40 x 25 mm	5
18847	TTa 45 x 25 mm	5

## Stahlberg

### BIT T



S2



MOQ 5

R.sz.	leírás	
18820	T5 x 25 mm	5
18821	T6 x 25 mm	5
18822	T7 x 25 mm	5
18823	T8 x 25 mm	5
18824	T9 x 25 mm	5
18825	T10 x 25 mm	5
18826	T15 x 25 mm	5
18827	T20 x 25 mm	5
18828	T25 x 25 mm	5
18829	T27 x 25 mm	5
18830	T30 x 25 mm	5
18831	T40 x 25 mm	5
18832	T45 x 25 mm	5

## Stahlberg

### BIT HTA



S2



MOQ 5

R.sz.	leírás	
18810	HTa 1,5 x 25 mm	5
18811	HTa 2,0 x 25 mm	5
18812	HTa 2,5 x 25 mm	5
18813	HTa 3,0 x 25 mm	5
18814	HTa 4,0 x 25 mm	5
18815	HTa 5,0 x 25 mm	5
18816	HTa 5,5 x 25 mm	5
18817	HTa 6,0 x 25 mm	5

## Stahlberg

### BIT T



S2



MOQ 3

R.sz.	leírás	
17980	T30 x 35 mm	3
17981	T40 x 35 mm	3

R.sz.	leírás	
17982	T45 x 35 mm	3
17983	T50 x 35 mm	3

## Stahlberg

### BIT SQ



S2



MOQ 5

R.sz.	leírás	
18850	SQ 0 x 25 mm	5
18851	SQ 1 x 25 mm	5
18852	SQ 2 x 25 mm	5
18853	SQ 3 x 25 mm	5

## Stahlberg

### BIT T



S2



MOQ 3

R.sz.	leírás	
17970	T20 x 75 mm	3
17971	T25 x 75 mm	3
17972	T30 x 75 mm	3
17973	T40 x 75 mm	3

R.sz.	leírás	
17974	T45 x 75 mm	3
17975	T50 x 75 mm	3
17976	T55 x 75 mm	3

## Stahlberg

### BIT SD



S2



MOQ 5

R.sz.	leírás	
18855	SD 6 x 25 mm	5
18856	SD 8 x 25 mm	5

## Stahlberg

### BIT TS



S2



MOQ 5

R.sz.	leírás	
18864	TS 4 x 25 mm	5
18865	TS 6 x 25 mm	5

## Stahlberg

### BIT 5/32', 3/16'



S2



MOQ 5

R.sz.	leírás	
18866	5/32 x 25 mm	5
18867	3/16 x 25 mm	5

## Stahlberg

### BIT TW



S2



MOQ 5

R.sz.	leírás	
18860	TW 1 x 25 mm	5
18861	TW 2 x 25 mm	5
18862	TW 3 x 25 mm	5
18863	TW 4 x 25 mm	5



**Stahlberg**  
BIT XZN



R.sz.	leírás	
18870	M4 x 25 mm	5
18871	M5 x 25 mm	5
18872	M6 x 25 mm	5
18873	M8 x 25 mm	5
18874	M10 x 25 mm	5



**Stahlberg**  
GIPSZKARTON BIT



R.sz.	leírás	
18795	PH 2 x 25 mm	24



**Stahlberg**  
GIPSZKARTON BIT

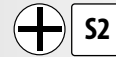

R.sz.	leírás	
18796	PH 2 x 55 mm	24



**Stahlberg**  
BIT ADAPTER

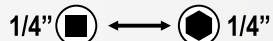

R.sz.	leírás	
18868	25 mm	5



**Stahlberg**  
BIT ADAPTER

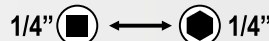

R.sz.	leírás	
18869	50 mm	5



**Stahlberg**  
ADAPTER RACSNI 1/4' - BIT

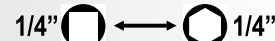

R.sz.	leírás	
18619		5



**Stahlberg**  
BIT BEFOGÓ, MÁGNESES



R.sz.	leírás	
18600	1/4' x 60 mm	5



**Stahlberg**  
BIT BEFOGÓ, MÁGNESES



R.sz.	leírás	
18797	1/4' x 60 mm	1



**Stahlberg**  
BIT BEFOGÓ, MÁGNESES

· gyors csatlakozó



R.sz.	leírás	
18601	1/4' x 60 mm	5



**Stahlberg**  
BIT BEFOGÓ, MÁGNESES

· gyors csatlakozó



R.sz.	leírás	
18798	1/4' x 60 mm	1



**Stahlberg**

**BIT BEFOGÓ, MÁGNESES**

· Ütközővel

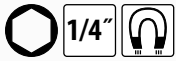

R.sz.	leírás
18602	1/4" x 60 mm



5



**Stahlberg**

**BIT BEFOGÓ, MÁGNESES**

· Ütközővel



R.sz.	leírás
18799	1/4" x 60 mm



1

**NEW**



**Stahlberg**

**BIT BEFOGÓ, MÁGNESES**



R.sz.	leírás
18605	150 mm



1

**NEW**



**FESTA**

**ADAPTER SDS + BIT 1/4"**



R.sz.	leírás
20743	75 mm



1



**BIT BEFOGÓ, MÁGNESES**



R.sz.	leírás
18607	80 mm



25



**Stahlberg**

**ADAPTER 1/4"**

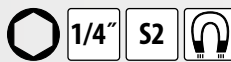

R.sz.	leírás		R.sz.	leírás	
18610	6 mm	5	18613	10 mm	5
18611	7 mm	5	18614	12 mm	5
18612	8 mm	5	18615	13 mm	5



5

**CSAVARBEHAJTÓ KLT. MÁGNESES**

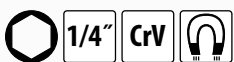

8x

R.sz.	leírás
18618	6, 7, 8, 9, 10, 11, 12, 13 mm



12

**BIT ÉS ADAPTER KÍNÁLÓ KLT.**

10x	⊕	18630	PH0
10x	⊕	18631	PH1
10x	⊕	18632	PH2
10x	⊕	18633	PH3
10x	⊕	18635	PZ0
10x	⊕	18636	PZ1
10x	⊕	18637	PZ2
10x	⊕	18638	PZ3
10x	⊕	18761	PH1 TiN
10x	⊕	18762	PH2 TiN
10x	⊕	18763	PH3 TiN
10x	⊕	18766	PZ1 TiN
10x	⊕	18767	PZ2 TiN
10x	⊕	18768	PZ3 TiN
10x	⊕	18770	PH1 DIAMANT
10x	⊕	18771	PH2 DIAMANT
10x	⊕	18775	PZ1 DIAMANT
10x	⊕	18776	PZ2 DIAMANT
10x	⊙	18814	4,0HTa
10x	⊙	18815	5,0HTa
10x	⊙	18842	20TTa
10x	⊙	18845	30TTa
10x	⊕	18795	PH2 Gipszkarton bit
5x		18612	ADAPTER 1/4" 8mm
5x		18613	ADAPTER 1/4" 10mm
5x		18600	Bit befogó, mágneses 1/4" 60mm
5x		18601	Bit befogó, mágneses 1/4" 60mm
5x		18602	Bit befogó, mágneses 1/4" 65mm

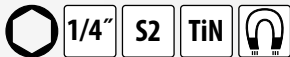

R.s. leírás

18993

1

**BIT KÍNÁLÓ KLT.**

10x	⊕	18631	PH1	
10x	⊕	18632	PH2	
10x	⊕	18633	PH3	
10x	⊕	18636	PZ1	
10x	⊕	18637	PZ2	
10x	⊕	18638	PZ3	
10x	⊕	18761	PH1	TiN
10x	⊕	18762	PH2	TiN
10x	⊕	18763	PH3	TiN
10x	⊕	18766	PZ1	TiN
10x	⊕	18767	PZ2	TiN
10x	⊕	18768	PZ3	TiN
10x	⊙	18804	H 4	
10x	⊙	18805	H 5	
10x	⊙	18825	T 10	
10x	⊙	18826	T 15	
10x	⊙	18827	T 20	
10x	⊙	18828	T 25	
10x	⊙	18830	T 30	
10x	⊙	18831	T 40	

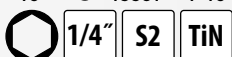

R.s. leírás

18994

1

**FESTA**

BIT KLT.



- ⊕ S 3 · 4 · 5 · 6
- PH 1 · 2 · 3
- ⊖ PZ 1 · 2 · 3
- H 3 · 4 · 5 · 6
- ⊕ T 10 · 15 · 20 · 25 · 27 · 30 · 40
- ⊕ TTa 10 · 15 · 20 · 25 · 27 · 30 · 40

· Bit befogó behajtóhoz, mágneses

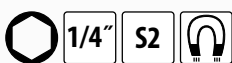

32x



R.s. leírás

18905

10

**FESTA**

BIT KLT.



- ⊕ S 4 · 5 · 6
- ⊖ PH 1 · 2 · 3
- ⊕ PZ 1 · 2 · 3
- H 3 · 4 · 5 · 6
- ⊕ T 10 · 15 · 20 · 25 · 27 · 30 · 40
- TTa 10 · 15 · 20 · 25 · 27 · 30 · 40

· Bit befogó behajtóhoz, mágneses

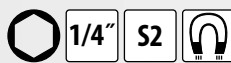

57x



R.s. leírás

18906

6

**FESTA**

BIT KLT.

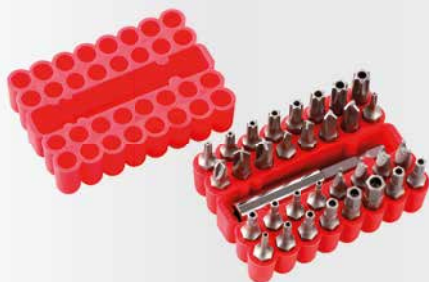

- ⊕ HTa 2 · 2.5 · 3 · 4 · 5 · 6
- 5/32" · 9/64" · 1/8"
- 7/64" · 3/32" · 5/64"

● SD 4 · 6 · 8 · 10

⊕ TS 6 · 8 · 10

⊕ TW 1 · 2 · 3 · 4

⊕ TTa 8 · 10 · 15 · 20 · 25 · 27 · 30 · 35 · 40

Mágneses toldalék bitekre

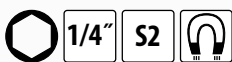

33x



R.s. leírás

18900

10

**FESTA**

BIT KLT.



- ⊕ S 3 · 4 · 4.5 · 5 · 5.5 · 6 · 6.5 · 7 · 8
- ⊕ PH 0 · 1 · 2 · 3
- ⊕ PZ 0 · 1 · 2 · 3
- ⊖ SQ 0 · 1 · 2 · 3
- ⊕ T 8 · 10 · 15 · 20 · 25 · 27 · 30 · 40 · 45
- ⊕ TTa 8 · 10 · 15 · 20 · 25 · 27 · 30 · 35 · 40
- H 1.5 · 2 · 2.5 · 3 · 4 · 5 · 5.5 · 6 · 8 mm
- 1/16" · 5/64" · 3/32" · 7/64" · 1/8" · 9/64"
- 5/32" · 3/16" · 7/32" · 1/4"
- ⊕ HTa 2 · 2.5 · 3 · 4 · 5 · 6 mm
- 5/64" · 3/32" · 7/64" · 1/8" · 9/64" · 5/32"
- SD 4 · 6 · 8 · 10
- ⊕ TS 6 · 8 · 10
- ⊕ TW 1 · 2 · 3 · 4
- ⊕ 2-wing 1 · 2 · 3
- ⊕ XZN 5 · 6 · 8

Mágneses toldalék bitekre

Toldalék bitekre

1/4" DR Csavarhúzó toldalék – hosszabbitó

1/4" bit adapter: 25mm, 50mm

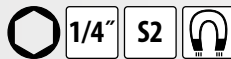

100x



R.s. leírás

18909

24

**FESTA**

BIT KLT.

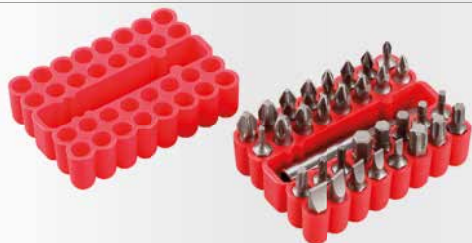

⊖ S 3 · 4 · 5 · 6 · 7

⊕ PH 0 · 1 · 2 · 3

● PZ 1 · 2 · 3

⊕ H 2 · 2.5 · 3 · 4 · 5 · 6

⊕ T 10 · 15 · 20 · 25 · 30 · 40

Mágneses toldalék bitekre

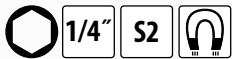

33x



R.s. leírás

18901

10

BIT KLT.

- ⊖ S 4 · 5 · 6 · 7
- ⊕ PH 1 · 2 · 3
- ✱ PZ 1 · 2 · 3
- H 4 · 5 · 6
- ★ T 10 · 15 · 20 · 25
- SQ 1 · 2 · 3

S2

20x



10



BIT KLT.

- ⊖ S 4 · 5 · 6 · 7
- ⊕ PH 1 · 2 · 3
- ✱ PZ 1 · 2 · 3

CrV TiN

10x



10

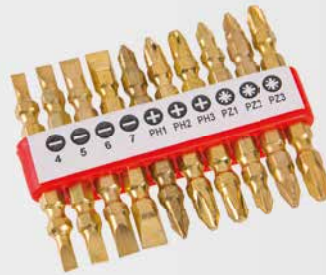

BIT KLT.

- ⊖ S 3 · 5 · 7
  - ⊕ PH 1 · 2 · 3
- Mágneses toldalék bitekre

HOBBY

7x



20



BIT KLT.

- ⊕ S 3 · 4 · 4,5 · 5 · 5,5 · 6 · 7
- ⊖ PH 1 · 2 · 3
- PZ 1 · 2 · 3
- H 2 · 3 · 4 · 5
- ★ T 20 · 30
- 1/4" 4 · 4,5 · 5 · 5,5 · 6 · 7 · 8 · 9 · 10
- 5/32" · 3/16" · 7/32" · 1/4" · 9/32" · 5/16" · 11/32" · 3/8" · 7/16"

Mágneses csavarhúzó toldalék bitekre  
2 db adatterr

1/4" CrV

41x



10



BIT KLT.

- ⊕ S 3 · 3,5 · 4 · 5,5
- ✱ PH 0 · 1 · 2 · 3
- ⊖ PZ 0 · 1 · 2 · 3
- H 3 · 4
- ★ T 10 · 15 · 20 · 25 · 27 · 30
- 1/4" 4 · 4,5 · 5 · 5,5 · 6 · 7 · 8 · 9 · 10 · 11 · 13

Csavarhúzó toldalék – hosszabbító  
Mágneses toldalék bitekre

CrV 1/4"

40x



10



SZERSZÁM KLT.

- ⊖ S 5 · 6 mm
- ⊕ PH 1 · 2
- H 3 · 4 · 5 · 6
- ★ T 15 · 20 · 25 · 30
- 1/4" 4 · 5 · 6 · 7 · 8 · 9 · 10 · 12 · 13 mm

75 mm 1/4" 1/4" 1/4"

1/4" CrV











































23x



10



**SZERSZÁM KLT.**

-  120mm
-  125mm
-  115mm
-  150mm max. 19mm
-  9mm
-  9mm
-  9mm
-  9mm
-  9mm
-  9mm
-  9mm
-  9mm
-  9mm
-  9mm
-  9mm
-  9mm
-  9mm
-  9mm
-  9mm
-  9mm
-  9mm
-  9mm
-  9mm
-  9mm
-  9mm
-  9mm
-  9mm
-  9mm
-  9mm
-  9mm
-  9mm
-  9mm
-  9mm
-  9mm
-  9mm
-  9mm
-  9mm
-  9mm
-  9mm
-  9mm
-  9mm
-  9mm
-  9mm

35x































R.sz. leírás  
17260



10

**FESTA**

**SZERSZÁM KLT.**

-  1/2", 1/4"
-  1/4" · 4-5-6-7-8-9mm
-  1/2" · 10-12-13-14-17-19mm
-  1/4" · 4-4.5-5-5.5-6-7-8-9-10-11-12-13-14mm
-  1/2" · 12-13-14-15-16-17-18-19-20-21-22-24mm
-  1/2", 1/4"
-  1/4" · 150mm
-  1/2" · 254mm
-  1/2", 1/4"
-  1/2" · 16-21mm
-  1/4" · 150mm
-  1/2" · E10-E12-E14-E16-E18-E20-E22-E24
-  1/4" · S 3 · 4 · 5 · 6
-  1/4" · PH 0 · 1 · 2
-  1/4" · PZ 0 · 1 · 2
-  1/4" · S 4 · 5,5 · 6,5
-  1/4" · PH 1 · 2 · 3
-  1/4" · PZ 2 · 3
-  1/4" · H 3 · 4 · 5 · 6
-  1/4" · T 8 · 10 · 15 · 20 · 25
-  1/4" · TTa 10 · 15 · 20 · 25 · 40
-  2 · 2,5 · 3 · 4 · 5 · 6 · 7 · 8 · 10mm
-  8-9-10-11-12-13-14-15-16-17-18-19mm
-  S 4x100 · 6,5x150
-  PH 2x100 · 3x150
-  180mm
-  160mm
-  160mm
-  250mm
-  300g

CrV S2 1/4" 1/2" 72T

122x

R.sz. leírás  
17238 122 db



1



**SZERSZÁM KLT.**

- 160 mm
- 160 mm
- 300 g
- 1/4" 45T
- 4 · 5 · 6 · 7 · 8 · 9 · 10 · 11 · 12 · 13 mm
- 1/4" 75 mm
- 1,5 · 2 · 2,5 · 3 · 4 · 5 · 6 · 8 · 10 mm
- S 3 · 4 · 5 · 6 mm
- PH 0 · 1 · 2 · 3
- PZ 0 · 1 · 2 · 3
- T 10 · 15 · 20 · 25
- H 3 · 4 · 5 · 6
- S 5x100 mm
- PH 1x100 · 2x100 mm
- S 2,5x50 mm
- PH 00x50 · 0x50 mm
- AC 100-250 V
- 200 mm max. 22 mm
- 10x11 · 12x13 · 14x15 · 16x17 mm
- 18 mm
- 2 m 13 mm



**60x**

R.sz. leírás

17259



5

**SZERSZÁM KLT.**

- 1/4" 5 · 6 · 7 · 8 · 9 · 10 · 11 · 12 mm
- 1/4"
- 1/4"
- AC 230 V
- PH 0, SL 3
- 9x 1,5-10 mm
- 160 mm
- S 3 · 4 · 5 · 6 mm
- PH 0 · 1 · 2 · 3
- H 4 · 5
- PH 2x100, S 6x100
- 18 mm
- 1 m
- 300 g



**32x**

R.sz. leírás

17247



10

**FESTA**

IMBUSZKULCS KLT. CRV

- H 1,5 mm
- H 2 mm
- H 2,5 mm
- H 3 mm
- H 4 mm
- H 5 mm
- H 6 mm
- H 8 mm
- H 10 mm



9x



R.s. leírás

18496

5

**FESTA**

IMBUSZKULCS KLT.

- H 1,5 mm
- H 2 mm
- H 2,5 mm
- H 3 mm
- H 4 mm
- H 5 mm
- H 6 mm
- H 8 mm
- H 10 mm



9x



R.s. leírás

18500

5

**FESTA**

IMBUSZKULCS KLT. CRV HOSSZITOTT

- H 1,5 mm
- H 2 mm
- H 2,5 mm
- H 3 mm
- H 4 mm
- H 5 mm
- H 6 mm
- H 8 mm
- H 10 mm



9x



R.s. leírás

18490

5

**FESTA**

IMBUSZKULCS KLT.

- H 1,5 mm
- H 2 mm
- H 2,5 mm
- H 3 mm
- H 4 mm
- H 5 mm
- H 6 mm
- H 8 mm
- H 10 mm



9x



R.s. leírás

18498

5

**FESTA**

IMBUSZKULCS KLT.

- 1/16"
- 5/64"
- 3/32"
- 1/8"
- 5/32"
- 3/16"
- 1/4"
- 5/16"
- 3/8"



9x



R.s. leírás

18493

6

**FESTA**

TORXKULCS KLT.

- T 10 mm
- T 15 mm
- T 20 mm
- T 25 mm
- T 27 mm
- T 30 mm
- T 40 mm
- T 45 mm
- T 50 mm



9x

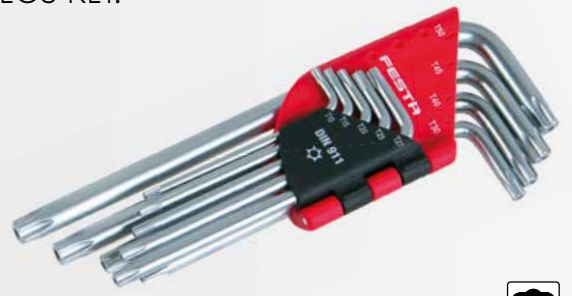

R.s. leírás

18497

5

**FESTA**

IMBUSZKULCS KLT. CRV HOSSZITOTT

- H 1,5 mm
- H 2 mm
- H 2,5 mm
- H 3 mm
- H 4 mm
- H 5 mm
- H 6 mm
- H 8 mm
- H 10 mm



9x



R.s. leírás

18492

10

**FESTA**

TORXKULCS KLT. CRV HOSSZITOTT

- T 10 mm
- T 15 mm
- T 20 mm
- T 25 mm
- T 27 mm
- T 30 mm
- T 40 mm
- T 45 mm
- T 50 mm



9x



R.s. leírás

18491

5

**FESTA**

## IMBUSZKULCS



R.sz.	leírás		
18548	8 mm	36 x 100 mm	1
18559	19 mm	70 x 180 mm	1
18562	22 mm	80 x 200 mm	1
18567	27 mm	100 x 250 mm	1
18572	32 mm	125 x 315 mm	1

**FESTA**

## IMBUSZKULCS - HOSSZÍTOTT



R.sz.	leírás		
18575	1,5 mm	15 x 75 mm	1
18576	2 mm	17 x 81 mm	1
18577	2,5 mm	18 x 87 mm	1
18578	3 mm	20 x 96 mm	1
18579	4 mm	24 x 107 mm	1
18580	5 mm	30 x 120 mm	1
18581	6 mm	33 x 136 mm	1
18582	7 mm	34 x 144 mm	1
18583	8 mm	36 x 153 mm	1
18584	9 mm	38 x 155 mm	1
18585	10 mm	40 x 171 mm	1
18586	11 mm	40 x 230 mm	1
18587	12 mm	42 x 250 mm	1
18588	13 mm	45 x 260 mm	1
18589	14 mm	56 x 280 mm	1
18593	17 mm	61 x 290 mm	1

**FESTA**

## IMBUSZKULCS - HOSSZÍTOTT



R.sz.	leírás		
18510	1,5 mm	15 x 75 mm	1
18511	2 mm	17 x 81 mm	1
18512	2,5 mm	18 x 87 mm	1
18513	3 mm	20 x 96 mm	1
18514	4 mm	24 x 107 mm	1
18515	5 mm	30 x 120 mm	1
18516	6 mm	33 x 136 mm	1
18518	8 mm	36 x 153 mm	1
18519	9 mm	38 x 155 mm	1
18520	10 mm	40 x 171 mm	1
18521	11 mm	40 x 230 mm	1
18522	12 mm	42 x 250 mm	1
18523	13 mm	45 x 260 mm	1
18524	14 mm	56 x 280 mm	1
18527	17 mm	61 x 290 mm	1

**FESTA**

## TORXKULCS



R.sz.	leírás	
18466	T7	1
18468	T9	1
18476	T45	1
18477	T50	1

**FESTA**

## IMBUSZKULCS KLT. CRV



R.sz.	leírás	
18508	1,5 · 2 · 2,5 · 3 · 4 · 5 · 6 mm	1



**FESTA**

CSAVARHÚZÓ KÉSZLET

- 2 mm
- 2,5 mm
- 3 mm
- 4 mm
- 5 mm
- 6 mm
- 7 mm
- 8 mm
- 10 mm



9x



R.s. leírás

18494

6



**FESTA**

CSAVARHÚZÓ KÉSZLET

- T 10
- T 15
- T 20
- T 25
- T 27
- T 30
- T 40
- T 45
- T 50



9x



R.s. leírás

18495

6



KÉSZLET IMBUSZKULCS



8x

R.s. leírás

18499 2 · 2,5 · 3 · 4 · 5 · 6 · 8 · 10 mm



1



**FESTA**

T CSAVARHÚZÓ TORX



R.s.	leírás		R.s.	leírás	
17350	T 7	10	17357	T 27	10
17351	T 8	10	17359	T 40	10
17352	T 9	10	17360	T 45	10
17353	T 10	10	17361	T 50	10

FESTA®



## KALAPÁCS ÉS KÉZIKALAPÁCS



FESTA®

## KALAPÁCS

· kőrisfa nyél

DIN  
1041

R.sz.	leírás	
19081	100 g	1
19082	200 g	1
19083	300 g	1
19084	400 g	1
19085	500 g	1
19086	600 g	1
19088	800 g	1
19090	1000 g	1
19092	1500 g	1
19095	2000 g	1



FESTA®

## KALAPÁCS

· kőrisfa nyél

DIN  
1041

R.sz.	leírás	
19096	3000 g	1
19097	4000 g	1
19098	5000 g	1
19106	6000 g	1
19108	8000 g	1
19109	10000 g	1

NEW



FESTA®

## KÉZIKALAPÁCS

· kőrisfa nyél

DIN  
6475

R.sz.	leírás	
19041	1000 g	1
19042	1250 g	1
19043	1500 g	1
19044	2000 g	1



FESTA®

## KÉZIKALAPÁCS

· kőrisfa nyél

DIN  
6475

R.sz.	leírás	
19045	<b>NEW</b> 3000 g	1
19046	<b>NEW</b> 4000 g	1
19074	5000 g	1
19075	6000 g	1
19076	8000 g	1
19077	10000 g	1

**FESTA****KALAPÁCS ÜVEGSZÁLAS**

· fiberglass

R.sz.	leírás		R.sz.	leírás	
19021	100 g	12	19026	600 g	6
19022	200 g	12	19028	800 g	6
19023	300 g	12	19030	1000 g	6
19024	400 g	12	19031	1500 g	6
19025	500 g	12	19032	2000 g	1

**FESTA****KÉZIKALAPÁCS ÜVEGSZÁLAS**

· fiberglass

**DIN 6475**

R.sz.	leírás	
19066	1000 g	4
19067	1250 g	4
19068	1500 g	4
19069	2000 g	2

**KALAPÁCS**

· kör alakú ék

**DIN 1041**

R.sz.	leírás	
19001	100 g	12
19002	200 g	12
19003	300 g	6
19004	400 g	6
19005	500 g	6
19006	600 g	6
19008	800 g	6
19010	1000 g	6
19015	1500 g	6
19020	2000 g	6

**FESTA****KALAPÁCS ÜVEGSZÁLAS**

· fiberglass

R.sz.	leírás	
19034	3000 g	4
19036	4000 g	4

**FESTA****KÉZIKALAPÁCS ÜVEGSZÁLAS**

· fiberglass

**DIN 6475**

R.sz.	leírás	
19070	3000 g	4
19071	4000 g	4
19058	5000 g	4
19059	6000 g	2

**KÉZIKALAPÁCS**

· kör alakú ék

**DIN 6475**

R.sz.	leírás	
19053	1000 g	6
19050	1250 g	6
19054	1500 g	6
19055	2000 g	6

**KÉZIKALAPÁCS**

· kör alakú ék

**DIN 6475**

R.sz.	leírás	
19056	3000 g	6
19057	4000 g	6

**FESTA**

## SUSZTER KALAPÁCS ÜVEGSZÁLAS NYÉL

· fiberglass

R.sz.	leírás	
19064	450 g	6

**FESTA**

## PALÁZÓ KALAPÁCS ÜVEGSZÁLAS NYÉL

· fiberglass



R.sz.	leírás	
19061	600 g	6

**FESTA**

## KŐMŰVES KALAPÁCS ÜVEGSZÁLAS NYÉL

· fiberglass

R.sz.	leírás	
19151	600 g	6

**FESTA**

## SUSZTER KALAPÁCS MONOLIT

R.sz.	leírás	
19063	450 g	6

**FESTA**

## PALÁZÓ KALAPÁCS MONOLIT



R.sz.	leírás	
19062	600 g	6

**FESTA**

## KŐMŰVES KALAPÁCS MONOLIT

R.sz.	leírás	
19150	600 g	6



## PALÁZÓ KALAPÁCS



R.sz.	leírás	
19100	600 g	6



**FESTA**  
SUSZTER KALAPÁCS

R.sz.	leírás	
19065	600 g	6



**FESTA**  
PALÁZÓ KALAPÁCS



R.sz.	leírás	
19060	600 g	6



**FESTA**  
KÉZIKALAPÁCS

R.sz.	leírás	
19051	1000 g	6
19052	1500 g	6



**FESTA**  
KALAPÁCS - FEJSZE

R.sz.	leírás	
19303	600 g	6



**FESTA**  
KŐMŰVES KALAPÁCS

· kőrisfa nyél

R.sz.	leírás	
19149	44 mm	1



**FESTA**  
KŐMŰVES KALAPÁCS

· kőrisfa nyél

R.sz.	leírás	
19124	24 mm	1
19136	36 mm	1
19148	48 mm	1



**FESTA**  
HEGESZTŐ KALAPÁCS



R.sz.	leírás	
19115	300 g	1



**FESTA**  
KŐMŰVES KALAPÁCS NYÉL

R.sz.	leírás	
61240	násada	1





## NÁKÉSZLET NA KALAPÁCS BÜKKFA



R.s.	leírás	kalapácsnak	
61320	26 cm	19081	10
61321	28 cm	19082	10
61322	30 cm	19083	10
61323	31 cm	19084	10
61324	32 cm	19085	10

R.s.	leírás	kalapácsnak	
61325	33 cm	19086	10
61326	35 cm	19088	10
61327	36 cm	19090	10
61328	38 cm	19092	10
61329	40 cm	19095	10



## KÉZIKALAPÁCS NYÉL



R.s.	leírás	kézikalapács	
61330	80 cm	19074, 19075	10
61331	90 cm	19076, 19077	10



## SZERZSÁMNYÉL ÉK, KÚPOS

R.s.	leírás	
19430	6 mm	10
19431	8 mm	10
19432	10 mm	10
19433	12 mm	10
19434	14 mm	10
19435	16 mm	10



## ÉK



R.s.	leírás	
19440	narrow	10
19441	middle	10
19442	wide	10
19443	wide S	10

**FESTA**

## ÉK



R.s.	leírás	
19398	20 x 25 x 5 mm	1
19399	30 x 40 x 5 mm	1

**3x**

**FESTA****KÉZIKALAPÁCS FÁBÓL**

· bükkfa nyél



R.sz.	leírás		
19202	Ø 60 x 120 mm	350 g	1

**FESTA****KÉZIKALAPÁCS FÁBÓL**

· bükkfa nyél



R.sz.	leírás		
19200	80 x 60 mm	520 g	1

**FESTA****GUMI KALAPÁCS**

· kőrisfa nyél



R.sz.	leírás		
19245	Ø 55 mm	400 g	1
19246	Ø 60 mm	800 g	1
19247	Ø 70 mm	1000 g	1
19248	Ø 95 mm	2000 g	1
19249	Ø 115 mm	3000 g	1

**FESTA****GUMI KALAPÁCS**

· üvegszálás nyél



R.sz.	leírás		
19270	Ø 55 mm		6
19271	Ø 65 mm		6
19272	Ø 90 mm		6

**FESTA****GUMI KALAPÁCS**

R.sz.	leírás		
19255	Ø 55 mm		6
19265	Ø 65 mm		6
19290	Ø 90 mm		6

**FESTA****GUMI KALAPÁCS, FEHÉR**

R.sz.	leírás		
19293	<b>NEW</b> Ø 55 mm		6
19294	Ø 65 mm		6
19295	Ø 90 mm		6



R.sz.	leírás		
19254	Ø 65 mm		6



GUMI KALAPÁCS



R.sz.	leírás	
19251	Ø 55 mm 400 g	12
19252	Ø 65 mm 700 g	6
19253	Ø 90 mm 1300 g	4



SÁRGARÉZ KALAPÁCS

· üvegszálás nyél

R.sz.	leírás	
19211	Ø 30 mm 500 g	1



DOMBORÍTÓ KALAPÁCS

R.sz.	leírás	
19297	Ø 35 mm	12



NYLON KALAPÁCS

· üvegszálás nyél



R.sz.	leírás	
19209	Ø 34 mm	6



KALAPÁCS CSERÉLHETŐ VÉGEKKEL

PP - 97 Shore A



TPE - 90 Shore A



TPU - 92 Shore A



TPU - 88 Shore A



TPU - 95 Shore A



TPE - 90 Shore A



TPU - 92 Shore A



TPE - 90 Shore A



R.sz.	leírás	
19208	Ø 40 mm	1



SZEKERCE

FESTA®





FESTA®

FEJSZE

DIN 5131

DIN 7294

- kőrisfa nyél
- kör alakú ék

R.sz.	leírás		R.sz.	leírás	
19380	600 g	1	19384	1400 g	1
19381	800 g	1	19385	1600 g	1
19382	1000 g	1	19387	2000 g	1
19383	1250 g	1			



FESTA®

SZEKERCE

- kőrisfa nyél

R.sz.	leírás	
19340	700 g	22



FESTA®

HASÍTÓ FEJSZE

- kőrisfa nyél
- kör alakú ék

DIN 5129

R.sz.	leírás	
19389	3000 g	1
19388	4000 g	1



FESTA®

HASÍTÓ FEJSZE ÉKES

- kőrisfa nyél
- kör alakú ék

DIN 7294

R.sz.	leírás	
19391	2000 g	1



## FEJSZE

R.sz.	leírás	
19306	600 g	24
19308	800 g	24
19310	1000 g	24
19312	1250 g	12
19314	1500 g	12



## FEJSZE NYÉL



R.sz.	leírás	kalapácsnak	
61340	36 cm	19380	10
61341	40 cm	19381, 19340	10
61342	50 cm	19382	10
61343	70 cm	19383, 19384	10

R.sz.	leírás	kalapácsnak	
61344	80 cm	19385, 19391	10
61345	90 cm	19387	10
61346	90 cm	19388, 19389	10



FESTA

## FEJSZE ÜVEGSZÁLAS

· fiberglass

R.sz.	leírás	
19326	600 g	6
19328	800 g	24
19330	1000 g	12



FESTA

## FEJSZE, KEMPING, ÜVEGSZÁLAS

· üvegszálás nyél

R.sz.	leírás	
19301	500 g	6



FESTA

## FEJSZE ÜVEGSZÁLAS

· üvegszálás nyél

R.sz.	leírás	
19392	1000 g	6



FESTA

## FEJSZE ÜVEGSZÁLAS

· üvegszálás nyél

R.sz.	leírás	
19390	2000 g	6



FESTA

## HASÍTÓ FEJSZE ÜVEGSZÁLAS

· üvegszálás nyél

R.sz.	leírás	
19370	3000 g	4
19371	4000 g	4



**Black Eagle**

**FEJSZE HASÍTÓ**



R.sz.	leírás	
19356	1200 g	5
19357	1800 g	1



**SDS+ HASÍTÓTÜSKE**



R.sz.	leírás	
19393	Ø 32 x 132 mm	10
19374	Ø 42 x 145 mm	10



**HASÍTÓ ÉK**

R.sz.	leírás	
19397	2000 g 55 x 210 x 45 mm	10
19465	2500 g 65 x 230 x 45 mm	10



**HASÍTÓ ÉK**

R.sz.	leírás	
19469	2500 g 165 x 87 mm	10



**HASÍTÓ ÉK**



R.sz.	leírás	
19462	175 x 65 x 20 mm	1
19463	230 x 70 x 30 mm	1
19464	240 x 75 x 40 mm	1



**HASÍTÓ ÉK**

R.sz.	leírás	
19394	1000 g 35 x 180 x 40 mm	6
19395	2000 g 40 x 255 x 55 mm	6
19396	2500 g 40 x 260 x 55 mm	8



# FESTO®



**FESTO**
**PAJSZER**

14 mm



R.sz.	leírás	
19424	400 mm	6
19425	600 mm	6
19426	800 mm	6
19427	1000 mm	6

**PAJSZER**

R.sz.	leírás	
19416	600 mm Ø 16 mm	4
19422	800 mm Ø 16 mm	4
19421	1000 mm Ø 18 mm	4

**SZEGHÚZÓ**

R.sz.	leírás	
19423	380 x 35 x 6 mm	1

**SZÖGHÚZÓ**

R.sz.	leírás	
19415	300 mm Ø 15 mm	6

**FESTA**

LAPOSVÉSŐ

CrV

R.sz.	leírás	szélesség hrotu	
19406	300 mm	25 mm	5
19407	400 mm	30 mm	5

**FESTA**

SPICCVÉSŐ

CrV

R.sz.	leírás	
19408	250 mm	5
19409	350 mm	5

**FESTA**

LAPOSVÉSŐ

CrV

R.sz.	leírás	szélesség hrotu	
19460	300 mm	25 mm	5
19470	400 mm	30 mm	5



SPICCVÉSŐ

R.sz.	leírás	
19400	250 mm	5
19403	350 mm	6



LAPOSVÉSŐ

R.sz.	leírás	szélesség hrotu	
19401	250 mm	19 mm	6
19404	350 mm	22 mm	6



LAPOSVÉSŐ

R.sz.	leírás	szélesség hrotu	
19402	250 mm	50 mm	2
19405	350 mm	50 mm	6

**FESTA**

LAPOSVÉSŐ

CrV

R.sz.	leírás	szélesség hrotu	
19410	200 mm	20 mm	10
19411	250 mm	25 mm	10
19412	300 mm	25 mm	10
19418	400 mm	25 mm	5
19419	500 mm	25 mm	5



LAPOSVÉSŐ

CrV

R.sz.	leírás	szélesség hrotu	
19436	200 mm	20 mm	15





FAVÉSŐ

**FESTA®**



**FESTA®**

FAVÉSŐ

**CrV**



R.sz.	leírás	
19490	6 mm   275 mm	6
19491	8 mm   275 mm	6
19492	10 mm   275 mm	6
19493	12 mm   275 mm	6
19494	14 mm   275 mm	6
19495	16 mm   275 mm	6

R.sz.	leírás	
19496	18 mm   280 mm	6
19497	20 mm   280 mm	6
19498	22 mm   280 mm	6
19499	25 mm   280 mm	6
19501	32 mm   290 mm	6
19502	38 mm   290 mm	6

FAVÉSŐ KLT.

- 8 mm
- 12 mm
- 19 mm
- 25 mm

**4x**



R.sz.	leírás	
19450		20

**FESTA®**

FAVÉSŐ KLT. FENŐKŐVEL

- 6 mm
- 10 mm
- 15 mm
- 20 mm
- 25 mm

**CrV 5x**



R.sz.	leírás	
19451		10

**FESTA®**

FAVÉSŐ KLT.

- 6 mm
- 12 mm
- 19 mm
- 25 mm

**CrV 4x**



R.sz.	leírás	
19457		10



**FESTA®**

MULTIFUNKCIÓS FAVÉSŐ

**INOX**

MOQ 12



R.sz.	leírás	
16231	20   80 mm	12

FAVÉSŐ KLT.

- 8 mm
- 12 mm
- 19 mm
- 25 mm

**4x**



R.sz.	leírás	
19455		30



**FESTA**

FAVÉSŐ KLT.

CrV

8x



R.sz.	leírás
19458	365   125mm



FAVÉSŐ KLT.

CrV

12x



R.sz.	leírás
19459	



GYALU



R.sz.	leírás
19510	220 x 65 x 130 mm, kés 48 mm



GYALU



R.sz.	leírás
19515	200 x 55 x 130 mm, kés 39 mm



GYALU



R.sz.	leírás
19520	225 x 27 x 155 mm, kés 27 mm



BÁDOGOS KÉSZLET

7x

R.sz.	leírás
19110	



# FESTA®







## TŰZŐGÉPEK



### FESTA®

#### TŰZŐGÉP





-  | 6 - 14 mm  
23960 - 23964  
23760 - 23764,  
23906 - 23914
-  | 10 - 14 mm  
23965
-  | 15 mm  
23966
-  | 15 mm  
23967

R.s. leírás  6

**23927**

### FESTA®

#### TŰZŐGÉP

-  | 6 - 14 mm  
23960 - 23964
-  | 12 mm  
23965
-  | 14 mm  
23966
-  | 14 mm  
23967





R.s. leírás  12

**23924**

### FESTA®

#### TŰZŐGÉP

-  | 6 - 14 mm  
23960 - 23964
-  | 14 mm  
23966
-  | 14 mm  
23967



R.s. leírás  12

**23923**

### FESTA®

#### TŰZŐGÉP

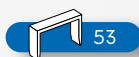
-  53 | 4 - 14 mm  
23904 - 23914,  
23760 - 23765



R.s. leírás  20

**23925** 4 - 14 mm with lock

### FESTA®

#### TŰZŐKAPOCS-ELTÁVOLÍTÓ



R.s. leírás  25

**23945**

TŰZŐGÉP

 53 | 4 - 14 mm  
23760 - 23765,  
23904 - 23914



R.sz.	leírás	
23800		20

TŰZŐGÉP

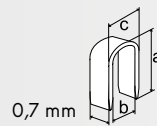

 α=9-11 mm, b=5,5mm, c=6,4mm



R.sz.	leírás	
23920		4



PROFI RÁÜTŐS TŰZŐGÉP

 | 6 - 10 mm  
23960 - 23962



R.sz.	leírás	
23922		10



RÁÜTŐS TŰZŐGÉP

 | 6 - 10 mm  
23960 - 23962



R.sz.	leírás	
23928		6



TŰZŐGÉPKAPOCS

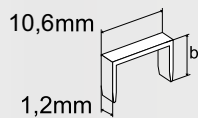

R.sz.	leírás	
23960	b=6 mm, 1000 db	50
23961	b=8 mm, 1000 db	50
23962	b=10 mm, 1000 db	50
23963	b=12 mm, 1000 db	50
23964	b=14 mm, 1000 db	50

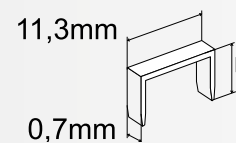

TŰZŐGÉPKAPOCS (TYP 53)

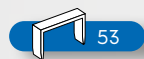

R.sz.	leírás	
23904	b=4 mm 1000 db	200
23906	b=6 mm 1000 db	200
23908	b=8 mm 1000 db	200
23910	b=10 mm 1000 db	200
23912	b=12 mm 1000 db	200
23914	b=14 mm 1000 db	200



TŰZŐGÉPKAPOCS

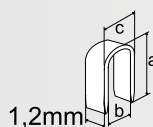

R.sz.	leírás	
23965	α=12 mm, b=6,5 mm, c=7,5 mm, 1000 TW	50



TŰZŐGÉPKAPOCS



R.sz.	leírás	
23966	14 mm   1000 TW	100



TŰZŐGÉPKAPOCS



R.sz.	leírás	
23967	14 mm   1000 TW	100

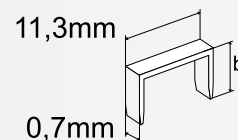

TŰZŐGÉPKAPOCS (TYP 53)  
CAPSE (TYPE 53)



R.sz.	leírás	
23760	b=4 mm 2000 db	10
23761	b=6 mm 2000 db	10
23762	b=8 mm 2000 db	10
23763	b=10 mm 2000 db	10
23764	b=12 mm 2000 db	10



## SZORÍTÓK ÉS SATUK

**FESTA**

## SZORÍTÓ

- kovácsolt
- picátúra forjató

R.sz.	leírás	
23560	200 x 80 mm	1
23561	300 x 100 mm	1
23562	400 x 100 mm	1
23563	500 x 120 mm	1

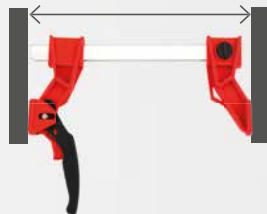

R.sz.	leírás	
23564	600 x 120 mm	1
23565	800 x 120 mm	1
23566	1000 x 120 mm	1

**FESTA**

## QUICK GRIP SZORÍTÓ



R.sz.	leírás	
23570	100 x 80 mm	1
23571	160 x 80 mm	1
23572	200 x 80 mm	1
23573	250 x 80 mm	1
23574	300 x 80 mm	1

**FESTA**

## PILLANATSZORÍTÓ



R.sz.	leírás		R.sz.	leírás		R.sz.	leírás	
23670	150 x 105 mm	1	23676	500 x 175 mm	1	23682	1500 x 175 mm	1
23671	200 x 105 mm	1	23677	600 x 175 mm	1	23683	1750 x 175 mm	1
23672	250 x 105 mm	1	23678	700 x 175 mm	1	23684	2000 x 175 mm	1
23673	300 x 105 mm	1	23679	800 x 175 mm	1	23685	2200 x 175 mm	1
23674	350 x 105 mm	1	23680	1000 x 175 mm	1			
23675	400 x 175 mm	1	23681	1250 x 175 mm	1			





## PILLANATSZORÍTÓ

DIN  
5117

R.sz.	leírás	
23506	300 x 120 mm	10
23507	500 x 120 mm	10
23508	800 x 120 mm	6

## PILLANATSZORÍTÓ

R.sz.	leírás	
23515	150 x 50 mm	50
23520	200 x 50 mm	50
23525	250 x 50 mm	50
23530	300 x 50 mm	50
23531	300 x 120 mm	20
23551	500 x 120 mm	10



FESTA

## SZORÍTÓ

R.sz.	leírás	
23625	200 mm	6
23626	300 mm	6
23628	450 mm	6
23630	600 mm	6
23632	760 mm	6

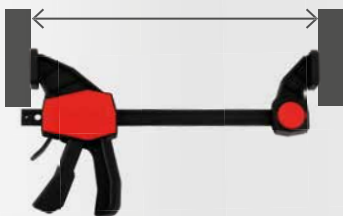

FESTA

## PILLANATSZORÍTÓ

R.sz.	leírás	
23585	150 mm	6
23587	300 mm	6
23589	450 mm	6
23591	600 mm	6



## RACSNIS SZORÍTÓ

· arasz 80 mm

R.sz.	leírás	
23605	9'   230 mm	6

## MŰANYAG CSIPESZ

R.sz.	leírás	
23600	4', arasz 40 mm	20
23601	6', arasz 50 mm	12
23602	9', arasz 80 mm	20

## G - SZORÍTÓ KÉSZLET

3x

R.sz.	leírás	
23620	25 mm, 50 mm, 75 mm	10



**FESTA**

**SATU**

edzett szorítópfák

R.sz.	leírás	
23410	100 mm	1
23411	125 mm	1
23412	150 mm	1



**SATU FORGATHATÓ**

edzett szorítópfák

R.sz.	leírás	
23415	100 mm	1
23416	125 mm	1
23417	150 mm	1



**ASZTALI SATU,**

R.sz.	leírás	
23407	65 mm	10



**GÉPI SATU**

edzett szorítópfák

R.sz.	leírás	
23400	18   80 mm	10
23401	22   100 mm	10
23402	24   125 mm	5



**SATU 90°**

**ALU**

hatótávolság 0-65 mm

R.sz.	leírás	
23420	65 mm	20



**ASZTALI SATU,  
FORGATHATÓ 360°**

**ALU**

R.sz.	leírás	
23406	80 mm	24

**NEW**



**MUNKAPAD**

· max. 100 kg

R.sz.	Leírás
23655	100 x 50 x 84 cm



1



**MUNKAPAD**

· ideális pincékhez

R.sz.	leírás
23660	



1



**MUNKAPAD**

R.sz.	leírás
23650	



1



**NEW**



**FESTA**

**ÁLLÍTHATÓ BAK**

· max. terhelés 590 kg

R.sz. Leírás

23657



1

**NEW**



**FESTA**

**HORDOZHATÓ ÁLLVÁNYOS SATU**

· tartomány: 0 - 95 cm

· maximális teherbírás: 250 kg

R.sz. Leírás

37553



1

# FESTA®

## POPSZEGECS FOGÓ

**FESTA®**
**SZEGECSELŐ  
FOGÓ**
**Cr-Mo**

  
 Ø 2,4 mm  
 Ø 3,2 mm  
 Ø 4,0 mm  
 Ø 4,8 mm







R.sz. leírás  
**24007** 200 mm



1

**FESTA®**
**SZEGECSELŐ  
FOGÓ**
**Cr-Mo**

  
 Ø 2,4 mm  
 Ø 3,2 mm  
 Ø 4,0 mm  
 Ø 4,8 mm





R.sz. leírás  
**24010** 250 mm



12



**FESTA**

SZEGECSELŐ FOGÓ

Cr-Mo

- Ø 2,4 mm
- Ø 3,2 mm
- Ø 4,0 mm
- Ø 4,8 mm
- Ø 6,4 mm



R.s. leírás  
24017 280 mm



1



**FESTA**

SZEGECSELŐ FOGÓ

Cr-Mo

- Ø 2,4 mm
- Ø 3,2 mm
- Ø 4,0 mm
- Ø 4,8 mm
- Ø 6,4 mm



R.s. leírás  
24015 530 mm



1



**FESTA**

SZEGECSELŐ FOGÓ

Cr-Mo

- Ø 2,4 mm
- Ø 3,0 mm
- Ø 3,2 mm
- Ø 4,0 mm
- Ø 4,8 mm



R.s. leírás  
24030 260 mm



24



**FESTA**

SZEGECSELŐ FOGÓ

Cr-Mo

- állítható fej szegecs
- 2 pozíciók



R.s. leírás  
24002 260 mm



6

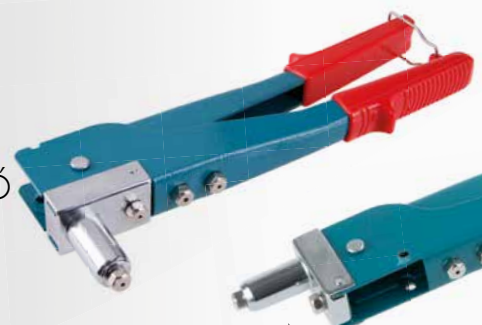

**FESTA**

SZEGECSELŐ FOGÓ

Cr-Mo

- Ø 2,4 mm
- Ø 3,2 mm
- Ø 4,0 mm
- Ø 4,8 mm



R.s. leírás  
24006 250 mm



12



SZEGECSELŐ FOGÓ + SZEGECSEK

Cr-Mo

- Ø 2,4 x 6 mm
- Ø 3,2 x 6 mm
- Ø 4,0 x 6 mm
- Ø 4,8 x 6 mm



R.s. leírás  
24005 260 mm



5



**FESTA**

SZEGECSELŐ FOGÓ

Cr-Mo



R.s. leírás  
24020 290 mm



8



SZEGECSELŐ FOGÓ

ALU

R.s. leírás  
24001 260 mm



6



SZEGECSELŐ FOGÓ

ALU

R.s. leírás  
24000 250 mm



24



**FESTA**SZEGERCELŐ FOGÓ A  
SZEGERCSANYAKHOZ**Cr-Mo**

- M3
- M4
- M5
- M6
- M8
- M10



R.sz.	leírás
24036	330 mm



1

**FESTA**SZEGERCELŐ FOGÓ A  
SZEGERCSANYAKHOZ**Cr-Mo**

- M3
- M4
- M5
- M6



R.sz.	leírás
24035	200 mm



1

**FESTA**

## SZEGERCELŐ FEJ

· A 24035 és 24036 szerszámokhoz

**Cr-Mo**

R.sz.	leírás	
24038	M3	1
24039	M4	1
24040	M5	1
24041	M6	1
24042	M8	1
24043	M10	1



## POPSZEGERCS

**ALU****50x**

R.sz.	leírás	
23970	3,2 x 6 mm	25
23971	3,2 x 8 mm	25
23972	3,2 x 10 mm	25
23973	3,2 x 12 mm	25
23974	3,2 x 14 mm	25
23975	4,0 x 6 mm	25
23976	4,0 x 8 mm	25
23977	4,0 x 10 mm	25
23978	4,0 x 12 mm	25
23979	4,0 x 14 mm	25
23985	4,8 x 6 mm	25
23986	4,8 x 8 mm	25
23987	4,8 x 10 mm	25
23988	4,8 x 12 mm	25
23989	4,8 x 14 mm	25

## SZEGERCELŐ ANYA

**ALU****20x**

R.sz.	leírás	
23950	M3 x 9 mm	20
23951	M4 x 11 mm	20
23952	M5 x 12 mm	50
23953	M6 x 14 mm	50
23954	M8 x 16,5 mm	25
23955	M10 x 18 mm	20



**FESTA**

## ÖSSZEKAPCSOLÓ FOGÓ PROFILOKRA



R.sz.	leírás	
17187	350 mm	6

**FESTA**

## ÖSSZEKAPCSOLÓ FOGÓ PROFILOKRA



R.sz.	leírás	
17188	250 mm	12



## SZEGECSELŐ PROFILOKRA



R.sz.	leírás	
17189	255 mm	12



## CSAPÁGYLEHÚZÓ



R.sz.	max. Ø	leírás	
23734	Ø 100 mm	50-95 mm	1
23735	Ø 150 mm	100-150 mm	1
23736	Ø 200 mm	110-190 mm	1



## CSAPÁGYLEHÚZÓ



R.sz.	max. Ø	leírás	
23730	Ø 100 mm	50-95 mm	2
23731	Ø 150 mm	100-150 mm	2
23732	Ø 200 mm	110-190 mm	2

**FESTA**

## INVERTERES HEGESZTŐ KÉSZÜLÉK TIG / MMA 160A

Tápfeszültség	230 V / 50 Hz
Üresjáratú feszültség	55 V
Hegesztőáram tartomány	10 - 160 A
Elektródák	1,5 - 4,0 mm
Munka ciklus	TIG- 160 A / 60%, MMA - 140 A / 60%
Védettség	IP 21
Hegesztés típusa	TIG/MMA
Méreték	405 x 165 x 270 mm
Technology:	Anti-stick, Arc-force, Hot start, Lift TIG
Tömeg	6 kg



R.sz.	leírás	
70040	Welding inverter TIG/MMA 160A	1
70045	Spare welding cables	1
70046	Spare heating torch TIG	1

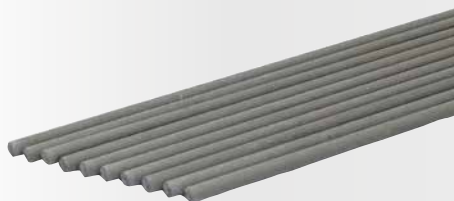

## RUTILELEKTRODA

hitelesített

R.sz.	leírás	mennyiség	
70021	Ø 2,0 x 300 mm	10 db	1
70020	Ø 2,0 x 300 mm	2,5 kg	8
70026	Ø 2,5 x 300 mm	10 db	1
70025	Ø 2,5 x 300 mm	2,5 kg	8
70033	Ø 3,2 x 350 mm	10 db	1
70032	Ø 3,2 x 350 mm	5 kg	4

## BASICELEKTRODA

hitelesített

R.sz.	leírás	mennyiség	
70030	Ø 2,0 x 300 mm	2,5 kg	1
70031	Ø 2,0 x 300 mm	5 kg	1
70035	Ø 2,5 x 300 mm	2,5 kg	8
70036	Ø 2,5 x 300 mm	10 db	1
70037	Ø 3,2 x 350 mm	5 kg	5
70038	Ø 3,2 x 350 mm	10 db	1

**FESTA****HEGESZTŐPAJZS ÖNSÖTÉTEDŐ**

látómező mérete	98 x 80 mm
szűrő sötétedési sebessége	1/25 000 s
szűrő elsötétítése	DIN 5-8 / 9-13
UV / IR védelem	DIN 16
optikai osztály	1   1   1   2
érzékelők száma	4
tápegység	napelem + elem CR2450 celula solara + baterie CR2450
munkamód	Hegesztés, köszörülés

LCD display

**CE EN**  
379

R.sz.	leírás	
70064	aktív	1
70066	cserre borító üveg	1

**FESTA****HEGESZTŐPAJZS ÖNSÖTÉTEDŐ CARBON**2x CR2032 3V  
CARBON  
7-15 shade

R.sz.	leírás	
70063	aktív	4

**HEGESZTŐPAJZS ÖNSÖTÉTEDŐ**2x AAA  
7-15 shade

R.sz.	leírás	
70060	aktív	4

**HEGESZTŐPAJZS PASSZÍV**UV-IR protection  
11 shade

R.sz.	leírás	
70061		4

**HEGESZTŐSZEMÜVEG**

UV-IR protection

R.sz.	leírás	
70062		1



HEGESZTŐPAJZS  
ÜVEG

2x

R.sz.	leírás	
70065	113 x 80 mm	20



HEGESZTŐ KALAPÁCS



R.sz.	leírás	
19115	300 g	1



ELEKTÓDA FOGÓ



R.sz.	leírás	
70070	300 A	1



TEST FOGÓ



R.sz.	leírás	
70075	300 A	1



**FESTA**

SAROKMÁGNES



R.sz.	leírás	nosnost	
70096	150 x 130 x 30 mm · 45°, 90°, 135°	25 kg	10



SAROKMÁGNES



R.sz.	leírás	nosnost	
70090	85 x 85 mm · 45°, 90°	9 kg	10



SAROKMÁGNES



R.sz.	leírás	nosnost	
70093	95 x 64 mm · 30°, 45°, 60°, 75°, 90°	9 kg	10
70094	120 x 90 mm · 30°, 45°, 60°, 75°, 90°	18 kg	10
70095	137 x 110 mm · 30°, 45°, 60°, 75°, 90°	27 kg	10



SAROKMÁGNES



R.sz.	leírás	nosnost	
70091	95 x 109 x 25 mm · 45°, 90°, 135°	13 kg	10
70092	130 x 150 x 32 mm · 45°, 90°, 135°	22 kg	5



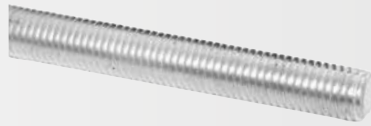

MENETESSZÁR

**DIN 976** **INOX**

**4.8** Szilárdsági osztály

R.sz.	leírás	
55311	M 5	1 m
55313	M 8	1 m
55314	M 10	1 m
55315	M 12	1 m
55316	M 14	1 m
55317	M 16	1 m
55318	M 18	1 m
55319	M 20	1 m

MENETESSZÁR

**DIN 975** **Zn**

**4.8** Szilárdsági osztály

R.sz.	leírás	
55040	M 4	1 m
55050	M 5	1 m
55060	M 6	1 m
55080	M 8	1 m
55100	M 10	1 m
55120	M 12	1 m
55140	M 14	1 m
55160	M 16	1 m
55180	M 18	1 m
55200	M 20	1 m
55220	M 22	1 m
55240	M 24	1 m
55300	M 30	1 m

MENETESSZÁR

**DIN 975**

**4.8** Szilárdsági osztály

R.sz.	leírás	
55041	M 4	1 m
55051	M 5	1 m
55181	M 18	1 m
55201	M 20	1 m
55221	M 22	1 m
55301	M 30	1 m

**NEW**



**FESTA**

ÉLTISZTÍTÓ

Ø 3 – 19 mm

**1/4"**

**16321**



5



HATLAPÚ ANYA

**DIN 934** **Zn**

**4.8** Szilárdsági osztály

R.sz.	leírás	
55350	M 4	100 db
55351	M 5	100 db
55352	M 6	100 db
55353	M 8	100 db
55354	M 10	100 db
55355	M 12	100 db
55356	M 14	100 db
55357	M 16	100 db
55358	M 18	100 db
55359	M 20	10 db
55360	M 22	10 db
55361	M 24	10 db
55362	M 30	10 db



ALÁTÉT DIN

**DIN 440R** **Zn**



R.sz.	leírás	
55331	M 5	100 db
55332	M 6	100 db
55333	M 8	100 db
55334	M 10	100 db
55335	M 12	100 db
55336	M 14	100 db
55337	M 16	100 db
55339	M 20	10 db
55340	M 22	10 db
55341	M 24	10 db
55342	M 30	10 db



**FESTA****OLAJMENTES KOMPRESSZOR 6 L**

Tápegység	230 V   50Hz
Kibocsátás	1,2 kW (1,5HP)
Utántöltő kapacitása	6 l
Működési nyomás	8 Bar
sebesség	3900 min.
Szívóerő	180 l/min.
Szabad levegőellátás	116 l/min.
Súly	10 kg



R.s.

35360



1

**OLAJMENTES KOMPRESSZOR 24 L**

Kibocsátás	1100 W
Tápegység	230 V   50Hz
Terhelésmentes futás	2850 min-1
Működési nyomás	8 bar
Szabad levegőellátás	160 l   min
Típus	Olajmentes   legare gumatá
Utántöltő kapacitása	24 L
Súly	23 kg



R.s.

leírás

35361 1,1 kW, 24 l



1

**KOMPRESSZOR 24 L**

Kibocsátás	1500 W
Tápegység	230 V   50Hz
Terhelésmentes futás	2850 min-1
Működési nyomás	8 bar
Szabad levegőellátás	200 l   min
Típus	olajsav   oleic
Utántöltő kapacitása	24 L
Súly	24 kg



R.s.

leírás

35362 1,5 kW, 24 l



1

**FESTA**

## KOMPRESSZOR KLT.

**5x**

- 1. olajpisztoly, levegős
- 2. levegőpisztoly nyomásmérővel
- 3. szorópisztoly, levegős
- 4. levegőpisztoly rövid
- 5. légtömlő csatlakozókkal



R.sz. leírás

48001

1

**FESTA**

## KOMPRESSZOR KLT.

**3x**

- 1. levegőpisztoly nyomásmérővel
- 2. levegőpisztoly rövid
- 3. légtömlő csatlakozókkal



R.sz. leírás

48002

1



800 ml

**FESTA**

## OLAJPISZTOLY, LEVEGŐS



R.sz. leírás

48015

spodní

1

**FESTA**

## ÜREGELŐ PISZTOLY, LEVEGŐS

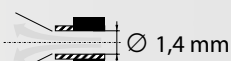

Ø 1,4 mm



R.sz. leírás

48036

spodní

1

500 ml



**FESTA**

SZORÓPISZTOLY, LEVEGŐS

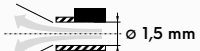

R.sz.	leírás	1
48020	felső	1

600 ml



**FESTA**

SZORÓPISZTOLY, LEVEGŐS

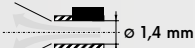

R.sz.	leírás	1
48021	felső	1
48047	Szórófej ∅ 1,7 mm	1

1000 ml



**FESTA**

SZORÓPISZTOLY, LEVEGŐS



R.sz.	leírás	1
48022	felső	1
48046	Szórófej ∅ 1,5 mm	1

600 ml



**FESTA**

LEVEGŐPISZTOLY RÖVID

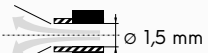

R.sz.	leírás	1
48030	dolní	1

SZÓRÓPISZTOLY FESTÉKEKHEZ ES VAKOLATOKHOZ

- 4 - 6 Bar
- 5 l
- Szórófej ∅ 4; 6; 8 mm



R.sz.	leírás	1
48037		1



**FESTA**

LEVEGŐPISZTOLY RÖVID



R.sz.	leírás	25
48005	rövid	25

50 mm



**FESTA**

LEVEGŐPISZTOLY KÖZEPES



R.sz.	leírás	25
48006	közepes	25

90 mm



**FESTA**

LEVEGŐPISZTOLY HOSSZÚ



R.sz.	leírás	25
48007	hosszú	25

**FESTA**LEVEGŐPISZTOLY  
NYOMÁSMÉRŐVEL

R.sz.	leírás
48010	1

**FESTA**

## LÉGTÖMLŐ CSATLAKOZÓKKAL

max. 20 Bar

R.sz.	leírás	svétlost	csomagolás
48031	5 m	ø 9/15 mm	1
48032	10 m	ø 9/15 mm	1
48033	15 m	ø 9/15 mm	1
48034	20 m	ø 9/15 mm	1

**FESTA**

## LÉGTÖMLŐ CSATLAKOZÓKKAL

R.sz.	leírás	svétlost	csomagolás
48043	5 m 8 atm	10 mm	1

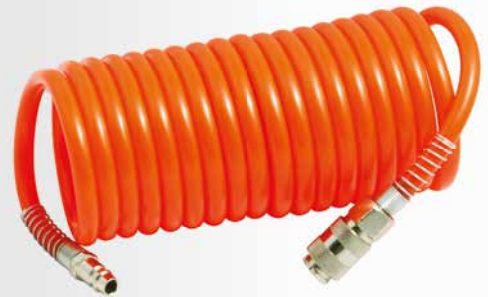
**FESTA**

## LÉGTÖMLŐ CSATLAKOZÓKKAL

R.sz.	leírás	svétlost	csomagolás
48040	5 m 8 atm	8 mm	1
48041	10 m 8 atm	8 mm	1
48042	15 m 8 atm	8 mm	1

**FESTA**

## VIZLEVÁLTÓ KOMPRESSZORHOZ

max. nyomás 10 bar



R.sz.	leírás	csomagolás
48008	G 1/4'	1

**FESTA**

## NYOMÁS SZABÁLYZÓ

nyomás tartomány 0 - 10 bar



R.sz.	leírás	csomagolás
48009	G 1/4'	1

**FESTA**

## TARTALÉK FÚVOKA

mert 48021

R.sz.	leírás	csomagolás
48047	Szórófej Ø 1,7 mm	1

**FESTA**

## TARTALÉK FÚVOKA

mert 48022

R.sz.	leírás	csomagolás
48046	Szórófej Ø 1,5 mm	1

## A WHITWORTHS CSŐSZÁLAK TÁBLÁJA

A SZÁLAK MÉRETE HÜVELYK BEN	MAX. A MENETEK KÜLSŐ Ø MM
1/8	9,728
1/4	13,157
3/8	16,662
1/2	20,955
3/4	26,441
1	33,249



## CSAPCSATLAKOZÓ

R.s.	leírás	
48075	1/4' külső	10
48076	3/8' külső	10
48077	1/2' külső	10
48095	1/4' belső	10
48096	3/8' belső	10
48097	1/2' belső	10

## KÖZCSAVAR

R.s.	leírás	
48054	3/8' külső x 1/4' belső	10
48055	1/2' külső x 3/8' belső	10
48056	3/8' külső x 1/2' belső	10
48057	1/4' külső x 3/8' belső	10

## KÖZCSAVAR

R.s.	leírás	
48050	1/4' külső x 1/4' külső	10
48051	1/4' külső x 3/8' külső	10



## CSAPCSATLAKOZÓ

R.s.	leírás	
48070	1/4' - 6 mm	10
48071	3/8' - 9 mm	10
48072	1/2' - 13 mm	10

## TÖMLŐBILINCS

R.s.	leírás	
48085	1/4' - 6 mm	10
48086	3/8' - 9 mm	10
48087	1/2' - 13 mm	10



## CSAPCSATLAKOZÓ

R.s.	leírás	
48080	1/4' külső	10
48081	3/8' külső	10
48090	3/8' belső	10
48091	1/4' belső	10

## CSAPCSATLAKOZÓ

R.s.	leírás	
48060	Ø 6 mm - 1/8' külső	10
48061	Ø 6 mm - 1/4' külső	10
48062	Ø 6 mm - 3/8' külső	10
48063	Ø 9 mm - 1/4' külső	10
48064	Ø 9 mm - 3/8' külső	10
48065	Ø 13 mm - 1/4' külső	10
48066	Ø 13 mm - 3/8' külső	10
48067	Ø 6 mm - 3/8' belső	10
48068	Ø 9 mm - 3/8' belső	10
48093	Ø 6 mm - 1/4' belső	10
48094	Ø 9 mm - 1/4' belső	10



## BIZTONSÁGI TERMÉKEK



## VÉDŐSZEMÜVEG

CE EN  
166

R.s. leírás

50510



10



## VÉDŐSZEMÜVEG

CE EN  
166

R.s. leírás

50514



10



## VÉDŐSZEMÜVEG

· Állítható oldalhossz

CE EN  
166

R.s. leírás

50511



12



## VÉDŐSZEMÜVEG

CE EN  
170

R.s. leírás

50512 ciemne



12



## VÉDŐSZEMÜVEG

CE EN  
166

R.s. leírás

50513



1



## FÜLTOK

CE EN 352 27 dB

R.s. leírás  
50563 1

## FÜLTOK

CE EN 352 27 dB

R.s. leírás  
50564 1

## ARCVÉDŐ PLEXI

CE EN 166

R.s. leírás  
50556 10

## VÉDŐSISAK CLIMAX

CE EN 397

MADE IN EU

R.s.	leírás	
50550	kék	30
50551	piros	30
50553	fehér	30
50554	sárga	30



## ARCVÉDŐ

CE EN 1731

R.s.  
50562 10

## FÉNYVISSZAVERŐ MELLÉNY

CE EN 20471

R.s.	leírás	
50570	narancs	100
50571	sárga	100



## FÜLDUGÓ

R.s. leírás  
50560 100

## FÜLDUGÓ

R.s. leírás  
50559 100





## PORMASZK

CE EN  
149

R.sz.	leírás	
50500	FFP2 szelep nélkül	30
50501	FFP1 szelep nélkül	30

## PORMASZK

CE EN  
149

R.sz.	leírás	
50502	FFP1 s ventilem	20
50503	FFP2 s ventilem	20

## SZÁJMASZK

50x

MOQ  
40

R.sz.	leírás	
50505		40



## VÉDŐKESZTYŰ, ERŐSÍTETT

· Béléssel a kezdedben

CE EN  
166

R.sz.	leírás	
50518	tméretű 11"	12

VÉDŐKESZTYŰ, ERŐSÍTETT,  
BÉLELT TENYÉR

· Béléssel a kezdedben

CE EN  
388

R.sz.	leírás	
50519	tméretű 10,5"	12

## HASÍTOTTBŐR KESZTYŰ

CE EN  
388

R.sz.	leírás	
50520	tméretű 10,5"	12



## BŐRKESZTYŰ ERŐSÍTETT

CE EN  
388

R.sz.	leírás	
50521	tméretű 10,5"	12

BŐRKESZTYŰ, ERŐSÍTETT  
THERMO BÉLESELCE EN  
388

R.sz.	leírás	
50523	tméretű 11"	12

PAMUTKESZTYŰ PVC  
PÖTTYÖKKEL

R.sz.	leírás	
50524	tméretű 10"	12



### PAMUTKESZTYŰ TELJESEN MÁRTOTT

CE EN  
388

R.s.	leírás	
50525	tméretű 10" - hossz 35 cm	12



### POLIÉSZTERKESZTYŰ PVC PÖTTYÖKKEL

· PVC pontokkal

R.s.	leírás	
50526	tméretű 10"	12



### PAMUTKESZTYŰ FÉLIGMÁRTOTT

CE EN  
388

R.s.	leírás	
50522	tméretű 10"	12



### NYLON KESZTYŰ NITRIL ÁZTATÁS

CE EN  
388

R.s.	leírás	
50533	tméretű 10"	12



### NYLON KESZTYŰ LATEX ÁZTATÁS

CE EN  
388

R.s.	leírás	
50537	tméretű 10"	12



### NYLON KESZTYŰ NITRIL ÁZTATÁS

· PVC pontokkal

CE EN  
388

R.s.	leírás	
50539	tméretű 10"	12



### ACRYL TÉLIKESZTYŰ LATEX ERŐSÍTÉS

CE EN  
388

R.s.	leírás	
50529	tméretű 10"	12



### PAMUTKESZTYŰ

R.s.	leírás	
50557	tméretű 7"	12
50558	tméretű 8"	12
50549	tméretű 9"	12



### PAMUTKESZTYŰ PVC PÖTTYÖKKEL KERTESZ

· PVC pontokkal

R.s.	leírás	
50531	tméretű 9"	12



### NYLON-KECSKEBŐR KESZTYŰ



R.sz.	leírás	
50541	tméretű 9"	12
50542	tméretű 10"	12



### NYLON-DISZNÓBŐR KESZTYŰK



R.sz.	leírás	
50544	tméretű 10"	12



### NYLON KESZTYŰ POLIURETÁN ÁZTATÁS



R.sz.	leírás	
50527	tméretű 10"	12



### HEGESZTŐ KESZTYŰ BŐR



R.sz.	leírás	
50540	tméretű 11"	12



### VINYL KESZTYŰ, EGYSZER HASZNALATOS

\* tiszta, pormentes



R.sz.	leírás	
50532	tméretű 9"	100



### FESTŐ OVERÁL

R.sz.	leírás	
50585	tméretű M	1
50586	tméretű L	1
50587	tméretű XL	1
50588	tméretű XXL	1



### KÖTÉNY HEGESZTÉSHEZ



R.sz.	leírás	
50555	bőr	1

**FESTA**

TÉRDVÉDŐ



TÉRDVÉDŐ PAD, MOBIL

R.s. leírás  
37135

1

R.s. leírás  
37145 gel

8

**FESTA**

TÉRDVÉDŐ

R.s. leírás  
37140 gel

12

**FESTA**

TÉRDVÉDŐ

R.s. leírás  
37144 gel

12

**FESTA**

TÉRDVÉDŐ

R.s. leírás  
37143

12

**FESTA**

TÉRDVÉDŐ

R.s. leírás  
37142 komfort

20

TÉRDVÉDŐ

R.s. leírás  
37139 neopren

10

TÉRDVÉDŐ

R.s. leírás  
37141

6

· Kiváló minőségű fém fogantyú, párnázott

· Tépozáras rögzítópánt a hosszú szerszám rögzítéséhez

· Kényelmes vállrész, levehető heveder

· 18 részes

· Megerosított belső konstrukció



**FESTO**

SZERSZÁMTÁSKA FÉM FOGANTYÚVAL

R.sz.	magasság	hossz	leírás	
37331	280 mm	490 mm	230 mm	2



**FESTO**

SZERSZÁMTÁSKA

R.sz.	szélesség	magasság	leírás	
37332	480 mm	290 mm	250 mm	1



**FESTO**

SZERSZÁMTÁSKA

R.sz.	szélesség	magasság	leírás	
37330	610 mm	400 mm	270 mm	5

**FESTA®**

## SZERSZÁMTÁSKA

R.s. leírás  
37325

10

**FESTA®**

## SZERSZÁMTÁSKA

Megerősített zsebek

R.s. leírás  
37326

12

**FESTA®**

## NYLON ÖV

R.s. leírás  
37328 145 cm

20

**FESTA®**



**FESTA**

**SZERSZÁM ÖV**

· 14 részes + szem



R.sz.	hossz	szélesség
37311	120 cm	6 cm

1



**FESTA**

**SZERSZÁMTOK**

· 8 részes



R.sz.	szélesség	magasság
37320	300 mm	250 mm

1



**FESTA**

**SZERSZÁMTOK**

· 4 részes



R.sz.	szélesség	magasság
37321	350 mm	300 mm

1



**FESTA**

**NYLON ÖV**



R.sz.	hossz	szélesség
37310	120 cm	6 cm

1



**FESTA**

**SZERSZÁMMELLÉNY**

R.sz.	leírás
37350	

20

**FESTA**

## ÁCS ÖVTÁSKA



R.sz.	leírás	
37302	6 részes	50
37303	11 részes	25



## ÁCS ÖVTÁSKA

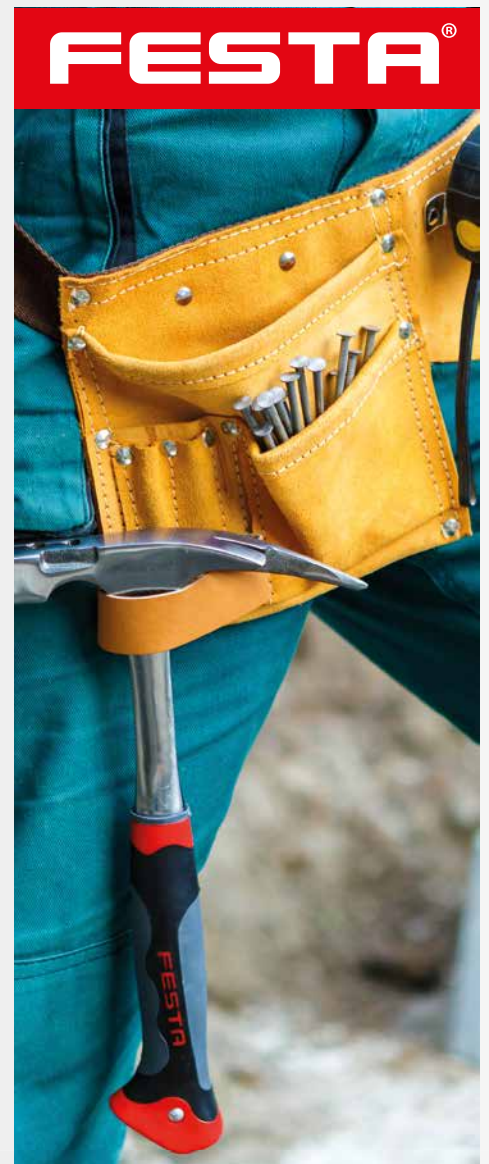

R.sz.	leírás	
37300	6 részes	50
37301	11 részes	25

**FESTA**<sup>®</sup>

## BŐRTÁSKA PROFI



R.sz.	magasság	hossz	leírás	
37342	270 mm	430 mm	180 mm	1



## BŐRTÁSKA VILLANYSZERELŐ



R.sz.	magasság	hossz	leírás	
37341	260 mm	430 mm	200 mm	1





## BÖRTÁSKA MEGERŐSÍTETT ALJJA



R.sz.	magasság	hossz	leírás	
37340	240 mm	430 mm	150 mm	1



## TÁSKA PROFI

R.sz.	magasság	hossz	leírás	
37344	250 mm	300 mm	130 mm	1



## TÁSKA MEGERŐSÍTETT ALJJA

R.sz.	magasság	hossz	leírás	
37343	240 mm	430 mm	150 mm	1



## TÁSKA VILLANYSZERELŐ

R.sz.	magasság	hossz	leírás	
37345	270 mm	430 mm	180 mm	1



## ÖVTARTÓ



R.sz.	leírás	
37308		20



## ÖVTARTÓ



R.sz.	leírás	
37309		20

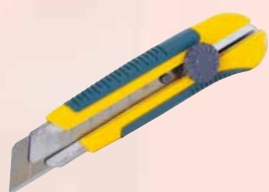

162

TÖRHETŐ PENGÉS KÉS KDS



164

TÖRHETŐ PENGÉS KÉS  
FESTA

170

KAPARÓ



171

PÓT PENGÉK

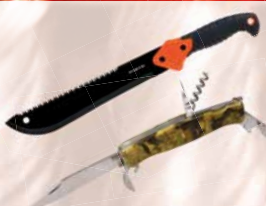

173

KÉS ÉS HOSSZÚ ÉLES KÉS



178

PVC CSŐ VÁGÓ



181

ELEKTROMOS PORISZTIROL  
VÁGÓ

184

CSIGAFÚRÓ FÉMHEZ



194

KÖZETFÚRÓ,  
HORONYMÁRÓ ÉS VÉSŐ

198

GYÉMÁNT KÖRKIVÁGÓ



204

CSIGAFÚRÓ FÁHOZ ÉS  
FÚRÓ-MARÓ VÉGEK

208

FÚRÓTKMÁNY

VÁGÓ ÉS CSISZOLÓ  
ESZKÖZÖK

160 - 241



210

KÖRKEFE DÖNTÖTT



214

CSISZOLÓ LAPOK



219

SZERSZÁMOK A  
GIPSKARTONHOZ



220

RÁSPOLY ÉS FÁJLOK



222

PROFI  
DEKOPIRFÚRÉSZLAPOK



225

ORRFÚRÉSZ LAPOK



228

FÉMFÚRÉSZ



234

GYÉMÁNT VÁGÓTÁRCSA



238

VÁGÁS ÉS ŐRLÉS LEMEZ

# KDS®

KDS japán törhető pengés kések

- kiváló ergonomikus fogás
- nagy teljesítményű és hosszú élettartamú pengék
- legjobb anyagból készült pengék
- kis vágási ellenállás

## KDS® TÖRHETŐ PENGÉS KÉS



R.sz.	leírás		
16002	LC405	18 mm zöld	25
16011	LB10	Tartalék penge	10



## KDS® TÖRHETŐ PENGÉS KÉS



R.sz.	leírás		
16003	G11	18 mm + 2 penge	10
16012	GB10	pót pengék	10



## KDS® TÖRHETŐ PENGÉS KÉS



R.sz.	leírás		
16019	LI9	18 mm + 2 penge	10
16011	LB10	pót pengék	10
16012	GB10	pót pengék	10





## KDS® TÖRHEŐ PENGÉS KÉS



R.sz.	leírás	db
16004	H11 25 mm	10
16013	HB10 Tartalék penge	10



## KDS® TÖRHEŐ PENGÉS KÉS



R.sz.	leírás	db
16005	S14 9 mm + 2 penge	10
16010	SB10 Tartalék penge	10



## KDS® TÖRHEŐ PENGÉS KÉS



R.sz.	leírás	db
16006	D12 + 16 penge	10



## KDS® PÓT PENGÉK



R.sz.	leírás	db
16010	SB10 9   0,38 mm	13 szegmens 20
16011	LB10 18   0,5 mm	15 szegmens 20
16012	GB10 18   0,6 mm	15 szegmens 20
16013	HB10 25   0,7 mm	7 szegmens 10

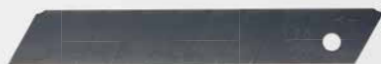

## KDS® PÓT PENGÉK

- Speciális ötvözet
- Kétszeres fenés
- Emelt élettartalom
- Alacsony vágási ellenállás könnyű vágást tesz lehetővé

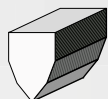

R.sz.	leírás	db
16016	LB10B 18   0,5 mm	8 szegmens 20
16017	HB10B 25   0,7 mm	7 szegmens 10



· szemléltető fotó

## KDS® KDS REKLÁM ÁLLVÁNY

- Elemek az állványban 16998 :
- 16001 · 5 db
  - 16003 · 5 db
  - 16004 · 3 db
  - 16005 · 3 db
  - 16006 · 2 db
  - 16008 · 3 db
  - 16010 · 4 db
  - 16012 · 4 db
  - 16013 · 1 db
  - 16016 · 4 db
  - 16018 · 4 db
  - 16019 · 4 db
  - 16020 · 4 db

R.sz.	leírás	db
16999	Reklám állvány	1
16998	Feltöltött állvány áruval	1

**FESTO**
**FESTO**
**KERÁMIA PENGÉS KÉS**

- 3x élesebb mint az acél pengék
- 10x hosszabb élettartam
- garanciabiztos, nem mágnesezhető, nem vezető



R.sz.	leírás	
16131	18 mm	10
16066	Tartalék penge 18 mm, 5 db	10

**FESTO**
**TÖRHEŐ PENGÉS KÉS**



R.sz.	leírás	
16110	L11 18 mm + 1 penge	12

**FESTO**
**TÖRHEŐ PENGÉS KÉS**

R.sz.	leírás	
16100	L12 18 mm + 1 penge	12

**FESTO**
**TÖRHEŐ PENGÉS KÉS**

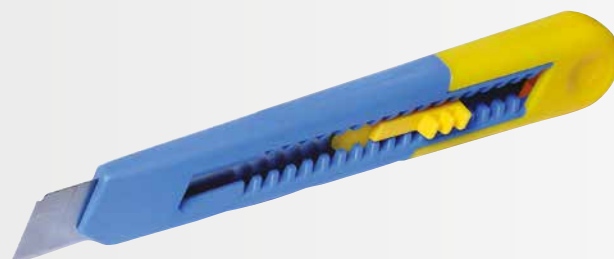
R.sz.	leírás	
16105	L17 18 mm + 1 penge	12

**FESTO**
**TÖRHEŐ PENGÉS KÉS**

R.sz.	leírás	
16125	L4 9 mm	24
16120	L8 18 mm	24

**FESTO**
**TÖRHEŐ PENGÉS KÉS**

R.sz.	leírás	
16115	L10 9 mm	24

**FESTO**
**TÖRHEŐ PENGÉS KÉS**
**ALU**

R.sz.	leírás	
16150	18 mm	24
16151	18 mm nyomtatás nélkül FESTO	20



**FESTA**

TÖRHEŐ PENGÉS KÉS

ALU



R.s.	leírás	
16136	18 mm	12



**FESTA**

TÖRHEŐ PENGÉS KÉS

ALU



R.s.	leírás	
16137	25 mm	12



**FESTA**

TÖRHEŐ PENGÉS KÉS

· Csúszásgátló gumi bevonat

+4 ALU



R.s.	leírás	
16090	18 mm	12



**FESTA**

TÖRHEŐ PENGÉS KÉS

· Csúszásgátló gumi bevonat

+4 ALU



R.s.	leírás	
16091	25 mm	6



**FESTA**

TÖRHEŐ PENGÉS KÉS

· Csúszásgátló gumi bevonat

ALU



R.s.	leírás	
16145	L25 18 mm	12



**FESTA**

TÖRHEŐ PENGÉS KÉS

· Csúszásgátló gumi bevonat

ALU



R.s.	leírás	
16144	L24 18 mm	12



TÖRHEŐ PENGÉS KÉS

ALU



R.s.	leírás	
16143	18 mm	12



TÖRHEŐ PENGÉS KÉS

ALU



R.s.	leírás	
16142	18 mm	12



### TÖRNETŐ PENGÉS KÉS

ALU



R.sz.	leírás
16025	18 mm

12



FESTA

### TÖRNETŐ PENGÉS KÉS

ALU



R.sz.	leírás
16029	18 mm

25



FESTA

### TÖRNETŐ PENGÉS KÉS

· Csúszásgátló gumi bevonat



R.sz.	leírás
16146	18 mm

12



FESTA

### TÖRNETŐ PENGÉS KÉS

· Csúszásgátló gumi bevonat



R.sz.	leírás
16147	25 mm

12



FESTA

### TÖRNETŐ PENGÉS KÉS

· Csúszásgátló gumi bevonat



R.sz.	leírás
16130	L18 18 mm + 5 pótpenge

12



FESTA

### TÖRNETŐ PENGÉS KÉS

· Csúszásgátló gumi bevonat



R.sz.	leírás
16135	L20 25 mm + 5 pótpenge

6



FESTA

### TÖRNETŐ PENGÉS KÉS

· Csúszásgátló gumi bevonat



R.sz.	leírás
16140	L22 18 mm

12



FESTA

### TÖRNETŐ PENGÉS KÉS

· Csúszásgátló gumi bevonat

ALU



R.sz.	leírás
16034	25 mm

12





**FESTA**

TÖRHETŐ PENGÉS KÉS

INOX

R.sz.	leírás
16085	9 mm



24



**FESTA**

TÖRHETŐ PENGÉS KÉS

INOX

R.sz.	leírás
16086	18 mm



24



BIZTONSÁGI KÉS

• önhúzódó pengék

R.sz.	leírás
16057	135 mm



12

**FESTA**

BIZTONSÁGI KÉS

ALU INOX

R.sz.	leírás
16058	Tartalék penge 10 db
16074	Tartalék penge 10 db



6

1



16074



**FESTA**

TÖRHETŐ PENGÉS KÉS

+5 ALU

R.sz.	leírás
16037	



6

**FESTA**

ÖSSZECSUKHATÓ KÉS

+5 ALU

R.sz.	leírás
16023	+ 5 pótpenge
16071	Tartalék penge 10 db



12

10



**FESTA**

LINÓLEUM VÁGÓKÉS

ALU

R.sz.	leírás
16095	25 pótpenge



1

**FESTA****LINÓLEUM VÁGÓKÉS**

· Csúszásgátló gumi bevonat



R.sz.	leírás
16035	+ 2 pótpenge

12

**FESTA****LINÓLEUM VÁGÓKÉS**

R.sz.	leírás
16033	NP 110 + 3 pótpenge

5

**FESTA****LINÓLEUM VÁGÓKÉS**

R.sz.	leírás
16038	+ 5 pótpenge

12

**LINÓLEUM VÁGÓKÉS**

R.sz.	leírás
16032	NP 109

48

**LINÓLEUM VÁGÓKÉS**

R.sz.	leírás
16031	NS 107 B

24

**LINÓLEUM VÁGÓKÉS**

R.sz.	leírás
16030	NS 107

24

**KÖRPENGÉS KÉS**

· szőnyegekhez és padlókhöz



R.sz.	leírás
16036	45 mm

12

**SZŐNYEGPADLÓVÁGÓ KÉS, HORGAS**

· szőnyegekhez és padlókhöz



R.sz.	leírás
16041	

12



## TÖRHEŐ PENGÉS KÉS

**ALU**



R.sz.	leírás	
16046	18 mm	12



## TÖRHEŐ PENGÉS KÉS

R.sz.	leírás	
16028	S 201 18 mm	24



## TÖRHEŐ PENGÉS KÉS

R.sz.	leírás	
16026	P 205 18 mm	30



## TÖRHEŐ PENGÉS KÉS

**HOBBY**

R.sz.	leírás	
16021	P 201 9 mm	60



## TÖRHEŐ PENGÉS KÉS

**HOBBY**

R.sz.	leírás	
16024	P 204 18 mm	60



## TÖRHEŐ PENGÉS KÉS 24 DB

Csúszásgátló gumi bevonat

MOQ  
24



R.sz.	leírás	
16141	18 mm	24



## KÉS KLT.

**HOBBY 12x**

R.sz.	leírás	
16053	9 mm	12
16055	18 mm	12



## KÉS KLT.

**HOBBY 3x**

R.sz.	leírás	
16043		24





## KAPARÓ

ALU



R.sz.	leírás	
16059	50 mm	10
16082	pót pengék	1



## KAPARÓ

ALU



· 18 mm-es pengével való használatra letörő késekhez

R.sz.	leírás	
16054	100 mm	1



FESTA

## KAPARÓ

· Csúszásgátló gumi bevonat



R.sz.	leírás	
16049		12
16069	pót pengék	1



FESTA

## MEGHOSSZABÍTOTT KAPARÓ



R.sz.	leírás	
16052	48 cm hossz	6
16070	pót pengék	25



## KAPARÓ



R.sz.	leírás	
16051		24



## KAPARÓ



R.sz.	leírás	
16050		24



## FÚGÁZÓ KLT.

3x



R.sz.	leírás	
16042		12



**FESTA**

## PÓT PENGÉK

- 7 szegmens
- 3x hosszabb élettartam
- dupla csiszolás
- alacsony vágási ellenállás

**SK2 10x**



R.s. leírás  
**16064** 25 | 0,7 mm

**20**



## PÓT PENGÉK

- 7 szegmens

**10x**



R.s. leírás  
**16068** 25 | 0,6 mm

**20**



**FESTA**

## PÓT PENGÉK

- 8 szegmens
- 3x hosszabb élettartam
- dupla csiszolás
- alacsony vágási ellenállás

**SK2 10x**

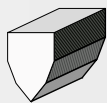

R.s. leírás  
**16062** 18 | 0,7 mm

**10**



**FESTA**

## PÓT PENGÉK

- 15 szegmens
- 3x hosszabb élettartam
- dupla csiszolás
- alacsony vágási ellenállás

**SK2 10x**

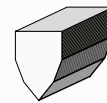

R.s. leírás  
**16063** 18 | 0,7 mm

**10**



**FESTA**

## KERÁMIA PÓT PENGÉK

- 8 szegmens
- 3x élesebb mint az acél pengék
- 10x hosszabb élettartam
- garanciabiztos, nem mágnesezhető, nem vezető

**5x**



R.s. leírás  
**16066** 18 | 0,6 mm

**10**



## PÓT PENGÉK

- 4 szegmens

**10x**



R.s. leírás  
**16067** 18 | 0,5 mm

**10**



## PÓT PENGÉK

- 8 szegmens

**10x**



R.s. leírás  
**16065** 18 | 0,5 mm

**60**



## PÓT PENGÉK

- 15 szegmens

**10x**



R.s. leírás  
**16081** 18 | 0,5 mm

**60**

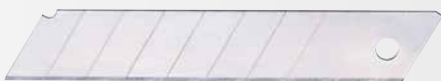

## PÓT PENGÉK

- 8 szegmens



- dupla csiszolás

**10x**



R.s. leírás  
**16078** 18 | 0,5 mm



**25**

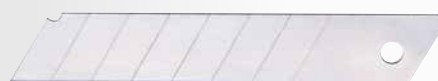

## PÓT PENGÉK

- 8 szegmens



- dupla csiszolás

**10x**



R.s. leírás  
**16077** 18 | 0,6 mm



**25**





### PÓT PENGÉK 30°

· 7 szegmens

10x

R.s. leírás  
16061 9 | 0,4 mm



60



### PÓT PENGÉK

· 13 szegmens

10x

R.s. leírás  
16060 9 | 0,45 mm

10



**FESTA**

### PÓT PENGÉK

· mert 16058

10x

R.s. leírás  
16074

1



**FESTA**

### PÓT PENGÉK

10x



R.s. leírás  
16072 R 004

10



**FESTA**

### PÓT PENGÉK

10x



R.s. leírás  
16075 R 003

10



### PÓT PENGÉK

10x

R.s. leírás  
16071 R 001

60



### PÓT PENGÉK

10x

R.s. leírás  
16073 R 002

60



### PÓT PENGÉK

5x

R.s. leírás  
16084 18 mm

50



### PÓT PENGÉK

5x

R.s. leírás  
16083 18 mm

50



### PÓT PENGÉK

· mert 34315

R.s. leírás  
34316

1



### PÓT PENGÉK

· mert 16052

R.s. leírás  
16070 100 mm

25



**FESTA**

## KÉS

- nejlon markolat
- teflon bevonatú penge
- övre akasztható tok, biztosító



R.s.	leírás	
16234	21   10 cm	10



**FESTA**

## VADÁSZKÉS



R.s.	leírás	
16229	23   10 cm	12



**FESTA**

## MULTIFUNKCIÓS VÉSŐ

- vastagított penge

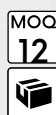

R.s.	leírás	
16231	20   8 cm	12



## MŰSZAKI KÉS, ERŐSÍTETT PENGÉVEL, TOKKAL

- vastagított penge



R.s.	leírás	
16230	21   10 cm	12



## MŰSZAKI KÉS, ERŐSÍTETT PENGÉVEL, TOKKAL



R.s.	leírás	
16022	16   6,5 cm	100



**FESTA**

## LINÓLEUM VÁGÓKÉS

R.s.	leírás	
16225	20   8,5 cm	12



**FESTA**

## KÉS

- vastagított penge



R.s.	leírás	
16212	15   3,2 cm	12



**FESTA**

## KÉS

R.s.	leírás	
16201	Ø 8 - 27 mm	10

**FESTA**

KÉS

INOX



R.s.	leírás
16211	20   8,5 cm

10
----

**FESTA**

KÉS

INOX



R.s.	leírás
16210	20,5   9 cm

10
----

**FESTA**

KÉS

INOX



R.s.	leírás
16219	19   11 cm

24
----

**FESTA**

KÉS

INOX



R.s.	leírás
16218	18,5   10,5 cm

24
----

**FESTA**

KÉS

INOX



R.s.	leírás
16220	18,5   11 cm

24
----

**FESTA**

KÉS

INOX



R.s.	leírás
16235	17,5   8,5 cm

24
----

**FESTA**

KÉS

INOX



R.s.	leírás
16221	21   12 cm

24
----

**FESTA**

KÉS

INOX



R.s.	leírás
16236	22,5   10 cm

24
----





**FESTA**

**KÉS**



R.s. leírás  
16209 14,5 | 5,5 cm

1



**FESTA**

**KÉS**

**INOX**



R.s. leírás  
16222 20 | 12 cm

24



**FESTA**

**KÉS**

**INOX ALU**



R.s. leírás  
16223 18,5 | 10,5 cm

24



**FESTA**

**KÉS**

· 10 funkció

**INOX**



R.s. leírás  
16226 17,5 | 7 cm

24



**FESTA**

**KÉS**

· 5 funkció

**INOX**



R.s. leírás  
16228 27 | 10,5 cm

24



**KÉS**

· 3 funkció



R.s. leírás  
16227 20,5 | 10 cm

24



**KÉS**

· 7 funkció

**INOX**



R.s. leírás  
16224 17,5 | 7 cm

24

**FESTA****MULTIFUNKCIÓS FOGÓ**

- 9 funkció
- Eset

**CrV**

R.sz.	leírás
16232	



12

**FESTA****KÉS ÁSVÁNYGYAPOTRA**

R.sz.	leírás
16198	44,5   33 cm



12

**FESTA****ÁSVÁNYGYAPOT, POLISZTIROL VÁGÓ KÉS**

- ásványgyapot, polisztirol

R.sz.	leírás
16199	48   35 cm



10



3 mm

**FESTA****BOZÓTVÁGÓ****TEFLON**

R.sz.	leírás
45069	440 mm

6



3 mm

**FESTA****BOZÓTVÁGÓ****TEFLON**

R.sz.	leírás
44950	490 mm

4

**BOZÓTVÁGÓ****INOX**

R.sz.	leírás
45083	430 mm
45084	600 mm

12

6

**BOZÓTVÁGÓ**

- fogantyú kőrisből készült

R.sz.	leírás
45081	510 mm
45082	710 mm

36

36



DEKOR SZIKE KLT.

23x



24

R.s. leírás

16282



DEKOR SZIKE KLT.

13x



10

R.s. leírás

16281



FENŐKŐ, KERÉKÍTETT

R.s. leírás

250 x 33 x 18 mm



20

45370

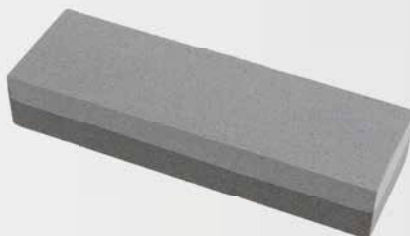

FENŐKŐ

R.s. leírás

150 x 50 x 30 mm



1

45045



FENŐKŐ

R.s. leírás

205 x 15 mm



100

45046



KÉS ÉS OLLÓ ÉLEZŐ

R.s. leírás

16991

20



KÉS ÉS OLLÓ ÉLEZŐ

R.s. leírás

16990

Ø 50 mm

1



KÉS ÉS OLLÓ ÉLEZŐ

R.s. leírás

45048



20



KÉS ÉS OLLÓ ÉLEZŐ 6 IN 1

R.s. leírás

45068



10

10

**FESTA****CSŐ HEGESZTŐ**

- tápfeszültség 230 V / 50 Hz
- teljesítmény 750 / 1500 W
- hőmérséklet 0-300 C°
- átmérők Ø 20,25,32,40,50,63 mm
- tömeg 1,6 kg



· a szerszámtartó tartalmaz mérőszalagot, vízmértéket, csavarhúzó, imbuszkulcs 6 hegesztő adapter, állvány, hordozó tok

R.s.

17182

**FESTA****CSŐ HEGESZTŐ**

- tápfeszültség 230 V / 50 Hz
- teljesítmény 800 / 1000 W
- hőmérséklet 0-300 C°
- átmérők Ø 16, 20, 25, 32 mm
- tömeg 1 kg



· a szerszámtartó tartalmaz imbusz kulcsot, 4 hegesztő adapter, állvány, hordozó tok

R.s.

17183





**FESTA**  
PVC CSŐ VÁGÓ

Ø max.  
42 mm



R.sz.	leírás	
17027		10
16315	Tartalék penge	1



**TARTALÉK PENGE 17027-HEZ**

· mert 17027

R.sz.	leírás	
16315		1

**NEW**



**FESTA**  
PVC CSŐ VÁGÓ

Ø max.  
32 mm



R.sz.	leírás	
17037		12



**PVC CSŐ VÁGÓ**

Ø max.  
42 mm



R.sz.	leírás	
17026		6



**FESTA**  
DARABOLÓ OLLÓ, PROFILOKHOZ

· lecek, csövek, profilok

Ø 17 mm   Ø 20 mm   Ø 27 mm

5x

R.sz.	leírás	
17050		8





**FESTA**

PVC CSŐ VÁGÓ

Ø 3-32 mm



R.sz.	leírás	
16301		10
16311	Tartalék penge	1



**FESTA**

PVC CSŐ VÁGÓ

Ø 6-64 mm



R.sz.	leírás	
16304		6
16312	Tartalék penge	1



PVC CSŐ VÁGÓ

Ø 3-32 mm



R.sz.	leírás	
16303		10
16311	Tartalék penge	1



PVC CSŐ VÁGÓ

Ø 3-32 mm



R.sz.	leírás	
16300		10
16310	Tartalék penge	1

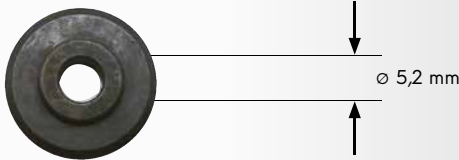

**NEW**



TARTALÉK VAGÓKERÉK PVC CSŐVÁGÓHOZ



R.sz.	leírás	
16310	Ø 17,5 mm x 6 m mert 16300	1
16311	Ø 18,0 mm x 4,5 mm mert 16303, 16301	1
16312	Ø 27,5 mm x 6 mm mert 16304	1

SORJÁZÓ

1/4"

R.sz.	leírás	
16321		1

CSŐSORJÁZÓ

Ø 6-32 mm

R.sz.	leírás	
16320		1



KÉZI MARÓK

1/4" HSS

4x



R.sz.	leírás	
20360		10



SORJÁZÓ

R.sz.	leírás	
20361		1



**FESTA**

## VEZETÉK NÉLKÜLI POLISZTIROL VÁGÓ

- akkumulátor 36 V, 1,5Ah Li-ion
- teljesítmény 180 W
- hőmérséklet max 350 C°
- penge hossz 20 cm



· felszerelés: 2 elem, töltő, penge, tisztító sárgaréz kefe, hatlapú

R.s. leírás  
**35323**



**FESTA**

## ELEKTROMOS PORISZTIROL VÁGÓ

- tápfeszültség 230 V/50 Hz
- teljesítmény 250 W
- hőmérséklet 50-600 C°
- penge hossz 25 cm
- tápkábel hossza 3 m



· Felszereltség: tisztító rézkefe, imbusz, pengék 25 és 30 cm, tartó doboz

R.s.	leírás	
35326	Elektromos porisztírol vágó	1
35328	pót penge 14 cm	1
35329	pót penge 25 cm	1



## VEZETŐ SABLON

R.s.	leírás	
35327	vezető sablon	1
35335	pót penge - 30 cm	1

**FESTA**

## ELEKTROMOS PORISZTIROL VÁGÓ



· temperature regulation

R.s. leírás  
**35325** 220 W



NEW

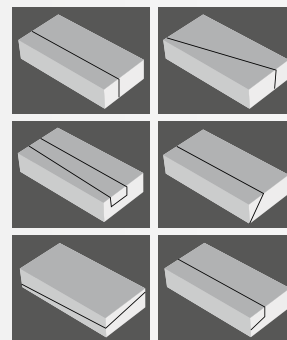

137 cm

FESTA

## POLISZTIROL VÁGÓ

- tápfeszültség: 230 V/50 Hz
- teljesítmény: 160 W
- vágás hossz: 137 cm
- vágási vastagság: 30 cm
- Védettség: IP44
- Vágási szög: 0° - 90°
- felszerelés: állvány, lábkapcsoló, állványtartó, 2x Ni-Cr vágóhuzal, tisztító sárgaréz kefe, számszámok és rögzítők, műanyag doboz kerekkel



R.s. Leírás

35348



1

NEW



1,7 m

FESTA

## LÁBKAPCSOLÓ

- 35330, 35345, 35348 esetén

R.s. Leírás

35334



1

NEW



FESTA

## ÁLLVÁNY

- 35330, 35345, 35348 esetén

R.s. Leírás

35336



1

NEW



FESTA

## CSERERÚGÓ

- 35330, 35345, 35348 esetén

R.s. Leírás

35332



1

NEW



FESTA

## ÁLLVÁNYTARTÓ

- 35330, 35345, 35348 esetén

R.s. Leírás

35333



1



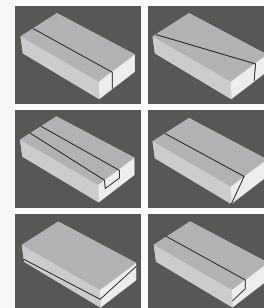
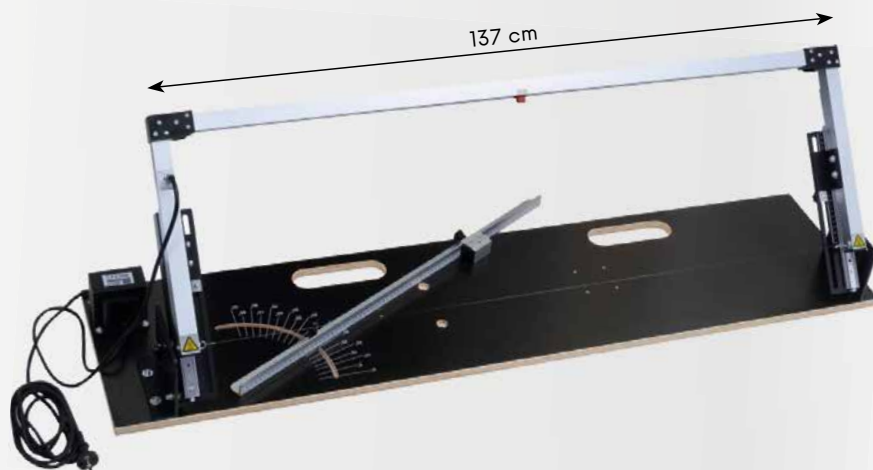

**FESTA**

## POLISZTIROL VÁGÓ

- tápfeszültség: 230 V / 50 Hz
- teljesítmény: 160 W
- vágás hossz: 137 cm
- vágási vastagság: 30 cm
- Védettség: IP44
- Vágási szög: 0° - 90°



· Felszereltség: Ni - Cr vágószál, tisztító rézkefe, imbusz



R.sz.	leírás	
35345	Polisztirol vágó 1500 x 450 mm	1
35346	Csere vágószál Ni - Cr	1
35347	Tartalék tápegység	1

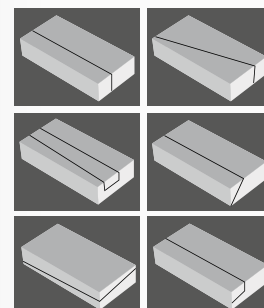
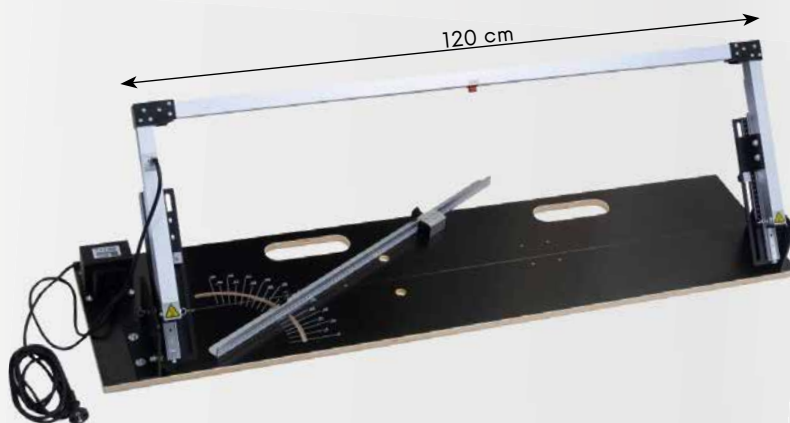

**FESTA**

## POLISZTIROL VÁGÓ

- tápfeszültség: 230 V / 50 Hz
- teljesítmény: 160 W
- vágás hossz: 120 cm
- vágási vastagság: 30 cm
- Védettség: IP44
- Vágási szög: 0° - 90°



· Felszereltség: Ni - Cr vágószál, tisztító rézkefe, imbusz

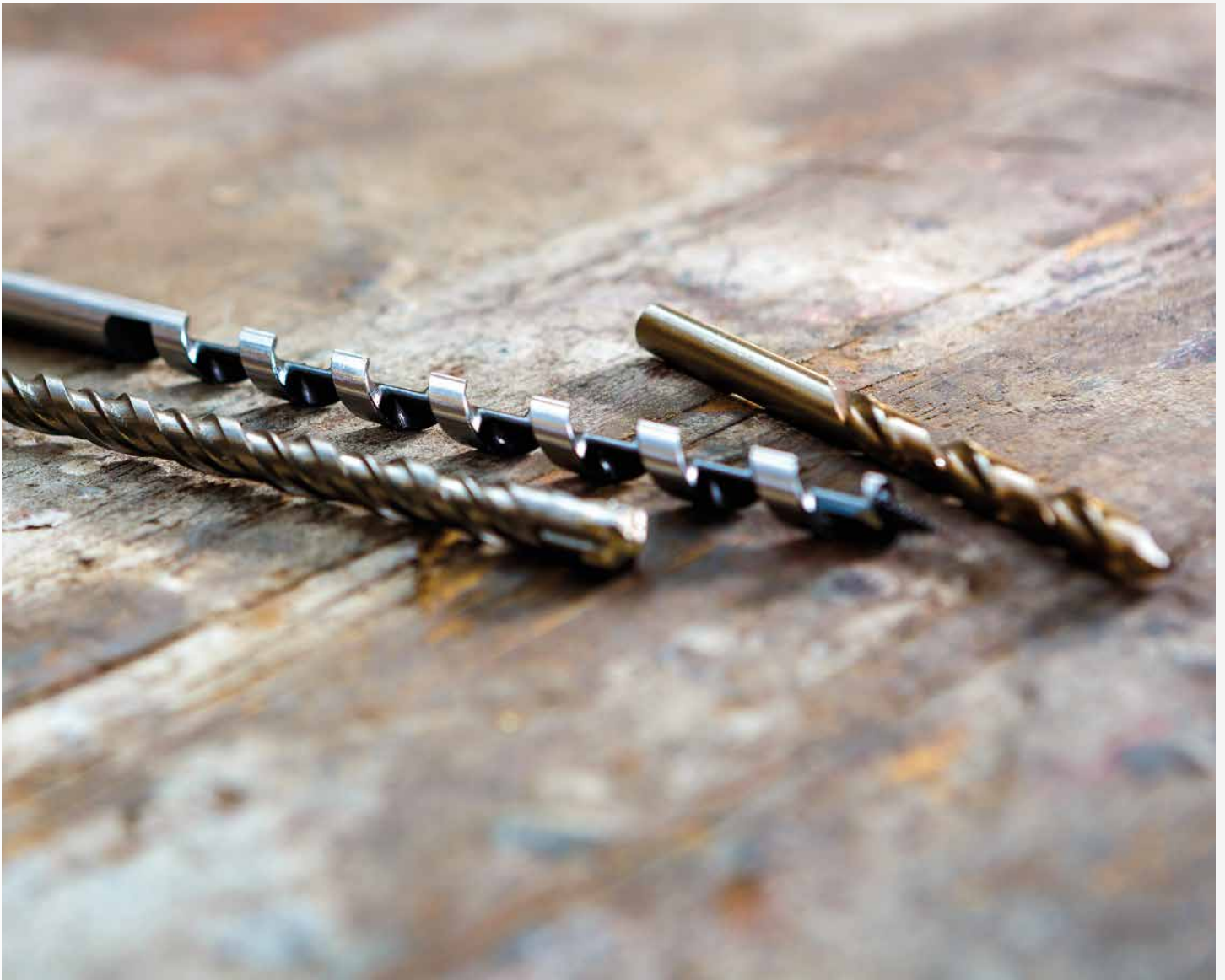

R.sz.	leírás	
35330	Polisztirol vágó 1350 x 450 mm	1
35331	Csere vágószál Ni - Cr	1
35347	Tartalék tápegység	1

**FESTA****CSIGAFÚRÓ FÉMHEZ HSS-COBALT 5%**Co 5%, W 6%  
Mo 5%, Cr 4%, V 4%**HSS****DIN****338****135°****INOX****1400**  
MPa

R.sz.	leírás		R.sz.	leírás		R.sz.	leírás	
22510	Ø 1,00 mm	1	22548	Ø 4,80 mm	1	22590	Ø 9,00 mm	1
22515	Ø 1,50 mm	1	22550	Ø 5,00 mm	1	22595	Ø 9,50 mm	1
22520	Ø 2,00 mm	1	22555	Ø 5,50 mm	1	22600	Ø 10,00 mm	1
22525	Ø 2,50 mm	1	22560	Ø 6,00 mm	1	22602	Ø 10,20 mm	1
22530	Ø 3,00 mm	1	22565	Ø 6,50 mm	1	22605	Ø 10,50 mm	1
22532	Ø 3,20 mm	1	22568	Ø 6,80 mm	1	22610	Ø 11,00 mm	1
22535	Ø 3,50 mm	1	22570	Ø 7,00 mm	1	22615	Ø 11,50 mm	1
22540	Ø 4,00 mm	1	22575	Ø 7,50 mm	1	22620	Ø 12,00 mm	1
22542	Ø 4,20 mm	1	22580	Ø 8,00 mm	1	22625	Ø 12,50 mm	1
22545	Ø 4,50 mm	1	22585	Ø 8,50 mm	1	22630	Ø 13,00 mm	1

**FESTA**
**CSIGAFÚRÓ FÉMHEZ HSS-G W9**

 W 9%, Mo 3%  
Cr 4%, V 1%

**HSS**
**DIN 338**
**INOX**

**1100 MPa**
**MOQ**

R.sz.	leírás	
19530	Ø 1,00 mm	10
19532	Ø 1,20 mm	10
19533	Ø 1,30 mm	10
19534	Ø 1,40 mm	10
19535	Ø 1,50 mm	10
19536	Ø 1,60 mm	10
19537	Ø 1,70 mm	10
19538	Ø 1,80 mm	10
19539	Ø 1,90 mm	10
19540	Ø 2,00 mm	10
19541	Ø 2,10 mm	10
19542	Ø 2,20 mm	10
19543	Ø 2,30 mm	10
19544	Ø 2,40 mm	10
19545	Ø 2,50 mm	10
19546	Ø 2,60 mm	10
19547	Ø 2,70 mm	10
19548	Ø 2,80 mm	10
19550	Ø 3,00 mm	10
19552	Ø 3,20 mm	10
19553	Ø 3,30 mm	10
19554	Ø 3,40 mm	10
19555	Ø 3,50 mm	10
19556	Ø 3,60 mm	10

R.sz.	leírás	
19557	Ø 3,70 mm	10
19558	Ø 3,80 mm	10
19559	Ø 3,90 mm	10
19560	Ø 4,00 mm	10
19561	Ø 4,10 mm	10
19562	Ø 4,20 mm	10
19563	Ø 4,30 mm	10
19564	Ø 4,40 mm	10
19565	Ø 4,50 mm	10
19566	Ø 4,70 mm	10
19568	Ø 4,80 mm	10
19569	Ø 4,90 mm	5
19570	Ø 5,00 mm	5
19573	Ø 5,30 mm	5
19574	Ø 5,40 mm	5
19575	Ø 5,50 mm	5
19576	Ø 5,60 mm	5
19577	Ø 5,70 mm	5
19578	Ø 5,80 mm	5
19579	Ø 5,90 mm	5
19580	Ø 6,00 mm	5
19581	Ø 6,10 mm	5
19583	Ø 6,30 mm	5
19584	Ø 6,40 mm	5

R.sz.	leírás	
19585	Ø 6,50 mm	5
19586	Ø 6,60 mm	5
19587	Ø 6,70 mm	5
19588	Ø 6,80 mm	5
19589	Ø 6,90 mm	5
19590	Ø 7,00 mm	5
19591	Ø 7,10 mm	5
19593	Ø 7,30 mm	5
19594	Ø 7,40 mm	5
19595	Ø 7,50 mm	5
19596	Ø 7,60 mm	5
19597	Ø 7,70 mm	5
19598	Ø 7,80 mm	5
19599	Ø 7,90 mm	5
19600	Ø 8,00 mm	5
19601	Ø 8,10 mm	5
19603	Ø 8,30 mm	5
19604	Ø 8,40 mm	5
19605	Ø 8,50 mm	5
19606	Ø 8,60 mm	5
19607	Ø 8,70 mm	5
19608	Ø 8,80 mm	5
19609	Ø 8,90 mm	5
19610	Ø 9,00 mm	5
19611	Ø 9,10 mm	5
19612	Ø 9,20 mm	5
19613	Ø 9,30 mm	5
19614	Ø 9,40 mm	5
19615	Ø 9,50 mm	3
19616	Ø 9,60 mm	3
19617	Ø 9,70 mm	3
19618	Ø 9,80 mm	3
19619	Ø 9,90 mm	3
19620	Ø 10,00 mm	3
19621	Ø 10,10 mm	3
19622	Ø 10,20 mm	3
19623	Ø 10,30 mm	3
19624	Ø 10,40 mm	3
19625	Ø 10,50 mm	3
19626	Ø 10,60 mm	3

R.sz.	leírás	
19627	Ø 10,70 mm	3
19628	Ø 10,80 mm	3
19629	Ø 10,90 mm	3
19630	Ø 11,00 mm	3
19631	Ø 11,10 mm	3
19632	Ø 11,20 mm	3
19633	Ø 11,30 mm	3
19634	Ø 11,40 mm	3
19635	Ø 11,50 mm	3
19636	Ø 11,60 mm	3
19637	Ø 11,70 mm	3
19638	Ø 11,80 mm	3
19639	Ø 11,90 mm	3
19640	Ø 12,00 mm	3
19641	Ø 12,10 mm	3
19642	Ø 12,20 mm	3
19643	Ø 12,30 mm	3
19644	Ø 12,40 mm	3
19645	Ø 12,50 mm	3
19646	Ø 12,60 mm	1
19647	Ø 12,70 mm	1
19648	Ø 12,80 mm	1
19649	Ø 12,90 mm	1
19650	Ø 13,00 mm	1
19651	Ø 13,20 mm R13	1
19652	Ø 13,50 mm R13	1
19653	Ø 14,00 mm R13	1
19654	Ø 14,50 mm R13	1
19655	Ø 15,00 mm R13	1
19656	Ø 15,50 mm R13	1
19657	Ø 16,00 mm R13	1
19658	Ø 16,50 mm R13	1
19659	Ø 17,00 mm R13	1
19660	Ø 17,50 mm R13	1
19661	Ø 18,00 mm R13	1
19662	Ø 18,50 mm R13	1
19663	Ø 19,00 mm R13	1
19664	Ø 19,50 mm R13	1
19665	Ø 20,00 mm R13	1

**FESTA**
**CSIGAFÚRÓ ÁLLVÁNY HSS-G W9**

 W 9%, Mo 3%  
Cr 4%, V 1%

**HSS**
**DIN 338**
**INOX**

**1100 MPa**

R.sz.	leírás	
19669		1
90191	fúrók nélkül	1

R.sz.	obsah sady	
19530	Ø 1,00 mm	20x
19535	Ø 1,50 mm	20x
19540	Ø 2,00 mm	20x
19545	Ø 2,50 mm	20x
19550	Ø 3,00 mm	20x
19552	Ø 3,20 mm	20x
19555	Ø 3,50 mm	20x
19558	Ø 3,80 mm	20x
19560	Ø 4,00 mm	30x
19562	Ø 4,20 mm	20x
19565	Ø 4,50 mm	20x
19568	Ø 4,80 mm	20x
19570	Ø 5,00 mm	15x
19575	Ø 5,50 mm	15x
19580	Ø 6,00 mm	30x
19585	Ø 6,50 mm	15x
19590	Ø 7,00 mm	15x
19595	Ø 7,50 mm	15x
19600	Ø 8,00 mm	15x
19605	Ø 8,50 mm	15x
19610	Ø 9,00 mm	15x
19615	Ø 9,50 mm	15x
19620	Ø 10,00 mm	15x
19625	Ø 10,50 mm	6x
19630	Ø 11,00 mm	6x
19635	Ø 11,50 mm	6x
19640	Ø 12,00 mm	6x
19645	Ø 12,50 mm	6x
19650	Ø 13,00 mm	6x



**FESTA**

## CSIGAFÚRÓ FÉMHEZ HSS 4241

W 4%, Mo 3%  
Cr 4%, V 1%

HSS

DIN  
338

ALU 900 MPa

MOQ

R.sz.	leírás	MOQ	R.sz.	leírás	MOQ
19670	Ø 0,6 mm	10	19694	Ø 3,1 mm	10
19671	Ø 0,8 mm	10	19695	Ø 3,2 mm	10
19672	Ø 0,9 mm	10	19696	Ø 3,3 mm	10
19673	Ø 1,0 mm	10	19697	Ø 3,4 mm	10
19674	Ø 1,1 mm	10	19698	Ø 3,5 mm	10
19675	Ø 1,2 mm	10	19699	Ø 3,6 mm	10
19676	Ø 1,3 mm	10	19700	Ø 3,7 mm	10
19677	Ø 1,4 mm	10	19701	Ø 3,8 mm	10
19678	Ø 1,5 mm	10	19702	Ø 3,9 mm	10
19679	Ø 1,6 mm	10	19703	Ø 4,0 mm	10
19680	Ø 1,7 mm	10	19704	Ø 4,1 mm	10
19681	Ø 1,8 mm	10	19705	Ø 4,2 mm	10
19682	Ø 1,9 mm	10	19706	Ø 4,3 mm	10
19683	Ø 2,0 mm	10	19707	Ø 4,4 mm	10
19684	Ø 2,1 mm	10	19708	Ø 4,5 mm	10
19685	Ø 2,2 mm	10	19709	Ø 4,6 mm	10
19686	Ø 2,3 mm	10	19710	Ø 4,7 mm	10
19687	Ø 2,4 mm	10	19711	Ø 4,8 mm	10
19688	Ø 2,5 mm	10	19712	Ø 4,9 mm	10
19689	Ø 2,6 mm	10	19713	Ø 5,0 mm	10
19690	Ø 2,7 mm	10	19714	Ø 5,1 mm	10
19691	Ø 2,8 mm	10	19715	Ø 5,2 mm	10
19692	Ø 2,9 mm	10	19716	Ø 5,3 mm	10
19693	Ø 3,0 mm	10	19717	Ø 5,4 mm	10

R.sz.	leírás	MOQ	R.sz.	leírás	MOQ
19718	Ø 5,5 mm	10	19760	Ø 9,7 mm	5
19719	Ø 5,6 mm	10	19761	Ø 9,8 mm	5
19720	Ø 5,7 mm	10	19762	Ø 9,9 mm	5
19721	Ø 5,8 mm	10	19763	Ø 10,0 mm	5
19722	Ø 5,9 mm	10	19764	Ø 10,1 mm	5
19723	Ø 6,0 mm	10	19765	Ø 10,2 mm	5
19724	Ø 6,1 mm	10	19766	Ø 10,3 mm	5
19725	Ø 6,2 mm	10	19767	Ø 10,4 mm	5
19726	Ø 6,3 mm	10	19768	Ø 10,5 mm	5
19727	Ø 6,4 mm	10	19769	Ø 10,6 mm	5
19728	Ø 6,5 mm	10	19770	Ø 10,7 mm	5
19729	Ø 6,6 mm	10	19771	Ø 10,8 mm	5
19730	Ø 6,7 mm	10	19772	Ø 11,0 mm	5
19731	Ø 6,8 mm	10	19773	Ø 11,2 mm	5
19732	Ø 6,9 mm	10	19774	Ø 11,3 mm	5
19733	Ø 7,0 mm	10	19775	Ø 11,4 mm	5
19734	Ø 7,1 mm	10	19776	Ø 11,5 mm	5
19735	Ø 7,2 mm	10	19777	Ø 11,6 mm	5
19736	Ø 7,3 mm	10	19778	Ø 11,7 mm	5
19737	Ø 7,4 mm	10	19779	Ø 11,8 mm	5
19738	Ø 7,5 mm	10	19780	Ø 11,9 mm	5
19739	Ø 7,6 mm	10	19781	Ø 12,0 mm	5
19740	Ø 7,7 mm	10	19782	Ø 12,2 mm	5
19741	Ø 7,8 mm	10	19783	Ø 12,5 mm	5
19742	Ø 7,9 mm	10	19784	Ø 12,8 mm	5
19743	Ø 8,0 mm	10	19785	Ø 12,9 mm	5
19744	Ø 8,1 mm	10	19786	Ø 13,0 mm	5
19745	Ø 8,2 mm	10	19787	Ø 13,2 mm R13	5
19746	Ø 8,3 mm	10	19788	Ø 13,5 mm R13	5
19747	Ø 8,4 mm	10	19789	Ø 14,0 mm R13	5
19748	Ø 8,5 mm	10	19790	Ø 14,5 mm R13	5
19749	Ø 8,6 mm	5	19791	Ø 15,0 mm R13	5
19750	Ø 8,7 mm	5	19792	Ø 15,5 mm R13	5
19751	Ø 8,8 mm	5	19793	Ø 16,0 mm R13	5
19752	Ø 8,9 mm	5	19794	Ø 16,5 mm R13	5
19753	Ø 9,0 mm	5	19795	Ø 17,0 mm R13	5
19754	Ø 9,1 mm	5	19796	Ø 17,5 mm R13	5
19755	Ø 9,2 mm	5	19797	Ø 18,0 mm R13	5
19756	Ø 9,3 mm	5	19798	Ø 18,5 mm R13	5
19757	Ø 9,4 mm	5	19799	Ø 19,0 mm R13	5
19758	Ø 9,5 mm	5	19800	Ø 19,5 mm R13	5
19759	Ø 9,6 mm	5	19801	Ø 20,0 mm R13	5



**FESTA**

## CSIGAFÚRÓ ÁLLVÁNY HSS

W 4%, Mo 3%  
Cr 4%, V 1%

HSS

DIN  
338

ALU 900 MPa

R.sz.	leírás	MOQ
19802		1
90192	fúrók nélkül	1

R.sz.	obsah sady	R.sz.	obsah sady
19673	Ø 1,00 mm 20x	19728	Ø 6,50 mm 20x
19678	Ø 1,50 mm 20x	19733	Ø 7,00 mm 10x
19683	Ø 2,00 mm 20x	19738	Ø 7,50 mm 10x
19688	Ø 2,50 mm 20x	19743	Ø 8,00 mm 10x
19693	Ø 3,00 mm 30x	19748	Ø 8,50 mm 10x
19695	Ø 3,20 mm 30x	19753	Ø 9,00 mm 10x
19698	Ø 3,50 mm 30x	19758	Ø 9,50 mm 10x
19701	Ø 3,80 mm 30x	19763	Ø 10,00 mm 10x
19703	Ø 4,00 mm 30x	19768	Ø 10,50 mm 10x
19705	Ø 4,20 mm 30x	19772	Ø 11,00 mm 10x
19708	Ø 4,50 mm 30x	19776	Ø 11,50 mm 10x
19711	Ø 4,80 mm 30x	19781	Ø 12,00 mm 10x
19713	Ø 5,00 mm 20x	19783	Ø 12,50 mm 10x
19718	Ø 5,50 mm 20x	19786	Ø 13,00 mm 5x
19723	Ø 6,00 mm 20x		

**FESTA**

## CSIGAFÚRÓ FÉMHEZ HSS

W 4%, Mo 3%  
Cr 4%, V 1%

HSS

DIN  
338



ALU



MOQ

R.sz.	leírás		R.sz.	leírás	
20220	Ø 2,0 mm x 85 mm	10	20255	Ø 5,5 mm x 139 mm	10
20225	Ø 2,5 mm x 95 mm	10	20260	Ø 6,0 mm x 139 mm	10
20230	Ø 3,0 mm x 100 mm	10	20270	Ø 7,0 mm x 156 mm	10
20235	Ø 3,5 mm x 110 mm	10	20280	Ø 8,0 mm x 165 mm	10
20240	Ø 4,0 mm x 119 mm	10	20290	Ø 9,0 mm x 175 mm	10
20245	Ø 4,5 mm x 126 mm	10	20296	Ø 10,0 mm x 184 mm	10
20250	Ø 5,0 mm x 132 mm	10			

## HSS TITAN CSIGAFÚRÓ

· titanium surface to enhance performance and durability

TiN HSS DIN  
338



ALU



R.sz.	leírás		R.sz.	leírás		R.sz.	leírás	
20400	Ø 1,0 mm	1	20411	Ø 4,8 mm	1	20422	Ø 9,5 mm	1
20401	Ø 1,5 mm	1	20412	Ø 5,0 mm	1	20423	Ø 10,0 mm	1
20402	Ø 2,0 mm	1	20413	Ø 5,5 mm	1	20424	Ø 10,2 mm	1
20403	Ø 2,5 mm	1	20414	Ø 6,0 mm	1	20425	Ø 10,5 mm	1
20404	Ø 3,0 mm	1	20415	Ø 6,5 mm	1	20426	Ø 11,0 mm	1
20405	Ø 3,2 mm	1	20416	Ø 6,8 mm	1	20427	Ø 11,5 mm	1
20406	Ø 3,5 mm	1	20417	Ø 7,0 mm	1	20428	Ø 12,0 mm	1
20407	Ø 3,8 mm	1	20418	Ø 7,5 mm	1	20429	Ø 12,5 mm	1
20408	Ø 4,0 mm	1	20419	Ø 8,0 mm	1	20430	Ø 13,0 mm	1
20409	Ø 4,2 mm	1	20420	Ø 8,5 mm	1			
20410	Ø 4,5 mm	1	20421	Ø 9,0 mm	1			

## CSIGAFÚRÓ FÉMHEZ HSS

HSS DIN  
338



ALU



R.sz.	leírás		R.sz.	leírás	
19841	Ø 4,1 mm 5 db	10			
19842	Ø 4,2 mm 5 db	10			
19845	Ø 4,5 mm 5 db	10			
19885	Ø 8,5 mm 1 db	10			
19895	Ø 9,5 mm 1 db	10			



**FESTA**  
FÚRÓ KÉSZLET, INOX

W 9%, Mo 3%  
Cr 4%, V 1% **HSS** **DIN 338**

13x



R.sz. leírás  
20333 Ø 1,5 - 6,5 mm

1



**FESTA**  
FÚRÓ KÉSZLET

W 4%, Mo 3%  
Cr 4%, V 1% **HSS** **DIN 338**

13x



R.sz. leírás  
20336 Ø 1,5 - 6,5 mm

1



**FESTA**  
FÚRÓ KÉSZLET, INOX

W 9%, Mo 3%  
Cr 4%, V 1% **HSS** **DIN 338**

19x



R.sz. leírás  
20334 Ø 1,0 - 10,0 mm

20



**FESTA**  
FÚRÓ KÉSZLET

W 4%, Mo 3%  
Cr 4%, V 1% **HSS** **DIN 338**

19x



R.sz. leírás  
20337 Ø 1,0 - 10,0 mm

20



**FESTA**  
FÚRÓ KÉSZLET, INOX

W 9%, Mo 3%  
Cr 4%, V 1% **HSS** **DIN 338**

25x



R.sz. leírás  
20335 Ø 1,0 - 13,0 mm

5



**FESTA**  
FÚRÓ KÉSZLET

W 4%, Mo 3%  
Cr 4%, V 1% **HSS** **DIN 338**

25x



R.sz. leírás  
20338 Ø 1,0 - 13,0 mm

10



**FESTA**

FÚRÓ KÉSZLET

TiN



9x



R.s. leírás  
20317 Ø 5-6-8 mm

20



**FESTA**

FÚRÓ KÉSZLET

1/4" HSS



7x



R.s. leírás  
20316 Ø 1,5-2-3-4-5-5,5-6 mm

20



FÚRÓ KÉSZLET

HSS DIN 338



19x



R.s. leírás  
20305 Ø 1,0 - 13,0 mm

25



FÚRÓ KÉSZLET

HSS DIN 338



25x



R.s. leírás  
20311 Ø 1,0 - 13,0 mm

10



FÚRÓ KÉSZLET

HSS DIN 338



13x



R.s. leírás  
20300 Ø 1,5 - 6,5 mm

50



FÚRÓ KÉSZLET

HSS DIN 338



19x



R.s. leírás  
20310 Ø 1 - 13 mm

10



## FÚRÓ KÉSZLET

TiN HSS DIN 338

INOX ALU

19x



R.sz.	leírás	
20320	Ø 1 - 10 x 0,5 mm	30



## FÚRÓ KÉSZLET

HSS DIN 338

ALU

19x



R.sz.	leírás	
20321	Ø 1 - 10 x 0,5 mm	5



## FÚRÓ KÉSZLET

HSS DIN 338

INOX

19x

R.sz.	leírás	
20315	Ø 1 - 10 mm	10



## FÚRÓ ÉLEZŐ

R.sz.	leírás	
20380	mert Ø 3,5 - 10 mm	20



**FESTA**

**HSS LÉPTETŐ FÚRÓSZÁR TITAN**

**TiN HSS**

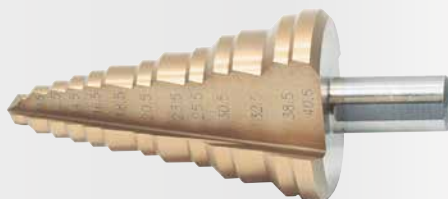

R.sz.	leírás	
20489	Ø 4 - 12 mm 8 steps	20
20490	Ø 4 - 20 mm 9 steps	10
20491	Ø 5 - 35 mm 13 steps	10
20492	Ø 7 - 40,5 mm 13 steps	5

**HSS LÉPTETŐ FÚRÓSZÁR**

**HSS**



R.sz.	leírás	
20487	Ø 4 - 20 mm 9 steps	10
20488	Ø 5 - 35 mm 13 steps	10
20494	Ø 4 - 32 mm 15 steps	10
20493	Ø 7 - 40,5 mm 13 steps	1

**FESTA**

**HSS LÉPTETŐ FÚRÓSZÁR TITAN**

**TiN HSS**



**3x**



R.sz.	leírás	
20495	Ø 4 - 12, 4 - 20, 4 - 32 mm	1

**HSS LÉPTETŐ FÚRÓSZÁR**

**HSS**



**3x**



R.sz.	leírás	
20496	Ø 4 - 12, 4 - 20, 4 - 32 mm	1

**FESTA****HSS KORONÁS FÚRÓ BIMETAL****HSS**

R.sz.	leírás	
24419	Ø 19 mm	1
24420	Ø 20 mm	1
24422	Ø 22 mm	1
24425	Ø 25 mm	1
24429	Ø 29 mm	1
24432	Ø 32 mm	1
24435	Ø 35 mm	1
24437	Ø 37 mm	1
24444	Ø 44 mm	1
24451	Ø 51 mm	1
24457	Ø 57 mm	1
24464	Ø 64 mm	1
24476	Ø 76 mm	1
24483	Ø 83 mm	1



14 - 30 mm

**FESTA****ADAPTER HSS-CO LYUKFŰRÉSZHEZ**

R.sz.	leírás	
24410	mert lyukfűrészhez 14 - 30 mm	1



32 - 152 mm

**FESTA****ADAPTER HSS-CO LYUKFŰRÉSZHEZ**

R.sz.	leírás	
24411	mert lyukfűrészhez 32 - 152 mm	1

**NEW****FESTA****TARTALÉK FÚRÓ A LYUKFŰRÉSZ TARTÓHOZ**

pro 24410, 24411

R.sz.	leírás	
24412		5

**FESTA****HSS KORONÁS FÚRÓ BIMETAL****HSS****9x**

R.sz.	leírás	
24750	Ø 19, 22, 29, 38, 44, 57 mm	10

**FESTA****HSS KORONÁS FÚRÓ BIMETAL****HSS****13x**

R.sz.	leírás	
24751	Ø 19, 22, 29, 35, 38, 44, 51, 57, 64 mm	10



**FESTA**  
TÖRTCSAVAR KISZEDŐ

- Ø 4 mm
- Ø 4,5 mm
- Ø 6,5 mm
- Ø 7,5 mm
- Ø 11 mm
- Ø 15 mm
- Ø 19 mm
- Ø 24 mm

8x

R.s. leírás  
20387



5



**FESTA**  
TÖRTCSAVAR KISZEDŐ

- Ø 4 mm
- Ø 4,5 mm
- Ø 6 mm
- Ø 7,5 mm
- Ø 11 mm

5x

R.s. leírás  
20386



10



**FESTA**  
TÖRTCSAVAR KISZEDŐ

- Ø 4 mm
- Ø 4,5 mm
- Ø 6 mm
- Ø 7,5 mm
- Ø 11 mm

5x

R.s. leírás  
20385



10



**FESTA**  
HAJTÓSZÁR RACSNIS

R.s. leírás  
20397 M3 - M8



10



**FESTA**  
MENETVÁGÓ HAJTÓSZÁR

DIN  
225

R.s. leírás  
20396 25 x 9 mm



10



**FESTA**  
MENETFÚRÓ HAJTÓSZÁR

DIN  
1814

R.s. leírás  
20395 1 - 1/2'; M3 - M12



10



**FESTA**  
MENETVÁGÓ ÉS FÚRÓ KLT.

32x

R.s. leírás  
20391 M 3, 4, 5, 6, 8, 10, 12 mm



1



**FESTA**  
MENETFÚRÓ KLT., FÉM DOBOZ

21x

R.s. leírás  
20390 M 3, 4, 5, 6, 8, 10, 12 mm



1

**FESTA****KÖZETFÚRÓ**

Kétoldalas fúrófej

**DIN 8039**

R.sz.	leírás	A mm	B mm	
20673	Ø 3 mm	60	30	100
20674	Ø 4 mm	75	40	100
20675	Ø 5 mm	85	50	100
20676	Ø 6 mm	100	60	100
20677	Ø 6 mm	200	160	50
20685	Ø 6 mm	300	260	50
20678	Ø 8 mm	120	75	50
20686	Ø 8 mm	200	155	50

R.sz.	leírás	A mm	B mm	
20687	Ø 8 mm	300	255	25
20688	Ø 8 mm	400	340	25
20680	Ø 10 mm	120	70	50
20690	Ø 10 mm	200	150	50
20691	Ø 10 mm	300	250	25
20692	Ø 10 mm	400	340	25
20682	Ø 12 mm	150	100	50
20694	Ø 12 mm	300	250	25

R.sz.	leírás	A mm	B mm	
20696	Ø 12 mm	400	340	25
20684	Ø 14 mm	150	90	25
Befogás Ø 10 mm				
20697	Ø 14 mm	300	240	5
Befogás Ø 10 mm				
20698	Ø 14 mm	400	340	15
Befogás Ø 10 mm				

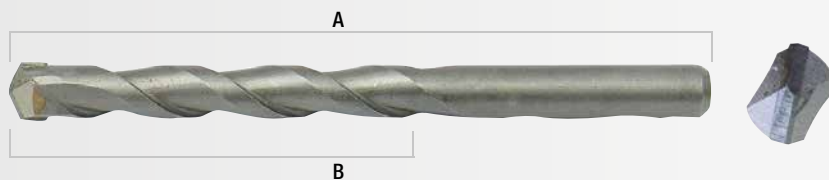
**FESTA****KÖZETFÚRÓ SDS+**

Kétoldalas fúrófej

**SDS+**

R.sz.	leírás	A mm	B mm	
20855	Ø 14 mm	160	75	25

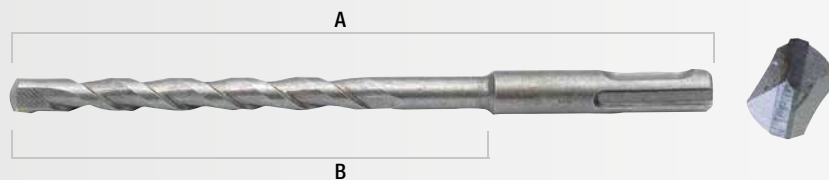
**FESTA****KÖZETFÚRÓ SDS+**

négy fúrási bit, a teljesítmény és az élettartam növekedésével

**SDS+**

R.sz.	leírás	A mm	B mm	
20748	Ø 6 mm	110	40	50
20749	Ø 6 mm	160	90	50
20750	Ø 6 mm	210	140	50
20751	Ø 6 mm	260	190	50
20861	Ø 6,5 mm	230	160	50
20862	Ø 6,5 mm	300	230	50
20752	Ø 8 mm	110	40	50
20753	Ø 8 mm	160	90	50
20754	Ø 8 mm	210	140	50
20755	Ø 8 mm	260	190	50
20825	Ø 8 mm	350	280	50
20756	Ø 10 mm	160	90	50
20757	Ø 10 mm	210	140	50
20758	Ø 10 mm	260	190	50
20759	Ø 10 mm	350	280	50
20760	Ø 10 mm	450	380	50
20761	Ø 10 mm	600	530	50
20762	Ø 10 mm	1000	930	50
20764	Ø 12 mm	160	80	50
20765	Ø 12 mm	210	130	50
20766	Ø 12 mm	260	180	50
20767	Ø 12 mm	350	270	50

R.sz.	leírás	A mm	B mm	
20768	Ø 12 mm	460	380	50
20769	Ø 12 mm	600	520	25
20770	Ø 12 mm	1000	920	25
20771	Ø 14 mm	160	80	25
20772	Ø 14 mm	260	180	25
20773	Ø 14 mm	350	270	25
20774	Ø 14 mm	460	380	25
20775	Ø 14 mm	600	520	25
20776	Ø 14 mm	1000	920	30
20777	Ø 16 mm	160	80	25
20778	Ø 16 mm	210	130	25
20779	Ø 16 mm	260	180	25
20780	Ø 16 mm	350	270	25
20781	Ø 16 mm	460	380	25
20782	Ø 16 mm	600	520	30
20783	Ø 16 mm	1000	920	25
20784	Ø 18 mm	260	180	25
20785	Ø 18 mm	450	370	25
20786	Ø 18 mm	600	520	32
20787	Ø 18 mm	1000	920	20
20788	Ø 20 mm	450	370	20
20789	Ø 20 mm	600	520	20

R.sz.	leírás	A mm	B mm	
20790	Ø 20 mm	800	720	25
20791	Ø 20 mm	1000	920	10
20792	Ø 22 mm	450	365	20
20793	Ø 22 mm	600	520	20
20794	Ø 22 mm	800	715	20
20795	Ø 22 mm	1000	920	10
20796	Ø 24 mm	450	365	10
20797	Ø 24 mm	600	520	20
20798	Ø 24 mm	800	715	10
20799	Ø 24 mm	1000	920	10
20870	Ø 26 mm	450	370	10
20871	Ø 26 mm	650	570	20
20872	Ø 26 mm	800	720	10
20873	Ø 26 mm	1000	920	10
20874	Ø 28 mm	450	365	10
20875	Ø 28 mm	600	565	20
20876	Ø 28 mm	800	715	10
20877	Ø 28 mm	1000	915	10
20878	Ø 30 mm	450	365	10
20879	Ø 30 mm	600	565	20
20880	Ø 30 mm	800	715	10
20881	Ø 30 mm	1000	915	10

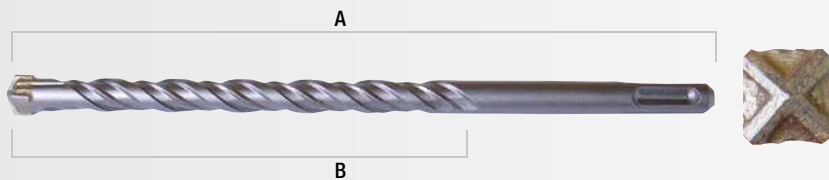

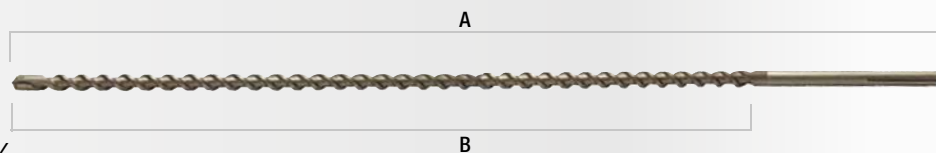

**FESTA**

## KÖZETFÚRÓ SDS MAX

· négy fúrási bit, a teljesítmény és az élettartam növekedésével

**SDS MAX**



R.s.	leírás	A mm	B mm	
20508	<b>NEW</b> Ø 16 mm	550	395	5
20510	Ø 18 mm	550	395	5
20520	Ø 18 mm	800	650	5
20511	Ø 20 mm	550	395	5
20521	Ø 20 mm	800	650	5

R.s.	leírás	A mm	B mm	
20512	Ø 22 mm	550	395	5
20522	Ø 22 mm	800	650	5
20513	Ø 24 mm	550	395	5
20523	Ø 24 mm	800	650	5
20514	Ø 28 mm	550	395	5

R.s.	leírás	A mm	B mm	
20524	Ø 28 mm	800	650	5
20515	Ø 30 mm	550	395	5
20525	Ø 30 mm	800	650	5
20516	Ø 40 mm	550	395	2
20526	Ø 40 mm	800	650	1



## ÁLLVÁNY

R.s. leírás

20999



1

## KÖZETFÚRÓ KÉSZLET SDS+

**SDS+**

**5x**



R.s.	leírás	
20890	Ø 5, 6, 8, 10, 12 mm 160 mm	25



## KÖZETFÚRÓ KÉSZLET SDS+

**SDS+**

**6x**



R.s.	leírás	
20891	Ø 5, 6, 8 mm 110 mm Ø 8, 10, 12 mm 160 mm	25



## FÚRÓKÉSZLET KÖRE

**DIN 8039**

**6x**



R.s.	leírás	
20895	Ø 5, 6, 8, 10, 12 mm	25



## KÖZETFÚRÓ KÉSZLET



R.s.	leírás	
20805	5 db Ø 4 - 10 mm	10
20820	8 db Ø 3 - 10 mm	10



**FESTA****FÚRÓ ÉS VÉSŐ KLT. SDS+**

- 2 x spicc véső
- 3 x lapos véső
- 12 x kőzetfúró Ø 5-12 mm

SDS+



17x

R.sz. leírás

20952

1

**FESTA****FÚRÓ ÉS VÉSŐ KLT. SDS+**

- 1 x spicc véső 250 mm
- 1 x horonymaró 22 x 250 mm
- 1 x lapos véső 20 x 250 mm

- Ø 5 x 110 mm
- Ø 6 x 110 mm
- Ø 8 x 160 mm
- Ø 10 x 160 mm
- Ø 12 x 160 mm
- Ø 14 x 210 mm
- Ø 16 x 210 mm
- Ø 18 x 310 mm
- Ø 20 x 450 mm

SDS+



12x

R.sz. leírás

20950

5

**FESTA****VÉSŐ KLT. SDS+**

SDS+

4x

R.sz. leírás

20954 250 mm



1

**FESTA****LAPOS VÉSŐ 15° SDS +**

SDS+

R.sz.

leírás  
20936 40 x 250 mm

5

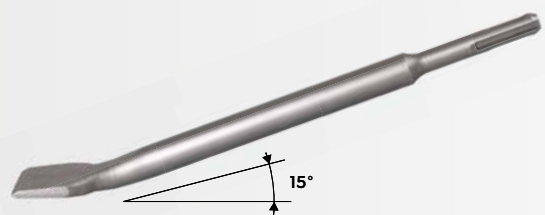



**FESTA**

## LAPOS VÉSŐ SDS MAX

**SDS MAX**



R.sz.	leírás	
20940	25 x 280 mm	5
20941	40 x 280 mm	5
20942	75 x 280 mm	5
20943	25 x 400 mm	5
20944	40 x 400 mm	5
20945	25 x 600 mm	5
20946	50 x 600 mm	5



**FESTA**

## LAPOS VÉSŐ SDS +

**SDS +**



R.sz.	leírás	
20948	20 x 250 mm	25
20990	20 x 400 mm	25
20949	40 x 250 mm	25
20991	40 x 400 mm	25



**FESTA**

## SPICC VÉSŐ SDS MAX

**SDS MAX**



R.sz.	leírás	
20937	Ø 18 x 280 mm	5
20938	Ø 18 x 400 mm	5
20939	Ø 18 x 600 mm	2



**FESTA**

## SPICC VÉSŐ SDS MAX

**SDS +**



R.sz.	leírás	
20947	250 mm	25
20992	400 mm	25



**FESTA**

## FÚRÓSZÁR BEFOGÓ ADAPTER SDS MAX

**SDS MAX**

R.sz.	leírás	
24730	180 mm	1



**FESTA**

## HORONYMARÓ SDS+

**SDS +**



R.sz.	leírás	
20956	22 x 250 mm	25



**FESTA**

## FÚRÓSZÁR BEFOGÓ ADAPTER SDS+

**SDS +**

R.sz.	leírás	
24731	300 mm	1
24732		1



**FESTA**

## ADAPTER SDS + BIT 1/4"

**SDS +**



R.sz.	leírás	
20743	75 mm	1



## ADAPTER SDS MAX-RÓL SDS+ RA

**SDS MAX**

**SDS +**

R.sz.	leírás	
20744		1

**FESTA****KORONA FÚRÓSZÁR SDS+**

- fúrószár befogó adapter 24730, 24731 a 24732

**SDS+**

R.sz.	leírás	
24719	Ø 67 mm	1
24717	Ø 73 mm	1
24723	Ø 80 mm	1
24718	Ø 100 mm	1
24757	Ø 115 mm	1
24758	Ø 125 mm	1
24759	Ø 150 mm	1

**KÖRKIVÁGÓ**

R.sz.	leírás	
24725	Ø 20-95mm	10

**KÖRKIVÁGÓ**

R.sz.	leírás	
24726	Ø 20-95mm	1

**FESTA****KÖRKIVÁGÓ KÉSZLET CSEMPÉRE****8x**

R.sz.	leírás	
24747	Ø 33, 53, 67, 73, 83 mm hordozó, fúró	1

**FESTA****KÖRKIVÁGÓ KÉSZLET CSEMPÉRE****6x**

R.sz.	leírás	
24745	Ø 33, 53, 67, 73 mm + hordozó, fúró	1



## FESTA

### KÖRKIVÁGÓ KO-RONG CSEMPÉRE



R.sz.	leírás	
24735	Ø 33 mm	1
24736	Ø 43 mm	1
24737	Ø 53 mm	1
24738	Ø 67 mm	1
24739	Ø 73 mm	1
24740	Ø 83 mm	1
24741	Ø 103 mm	1



## FESTA

### KÖRKIVÁGÓ KESZLET, CSEMPÉRE

3x



R.sz.	leírás	
24746	Ø 103 mm + hordozó, fúró	1



## FESTA

### HORDOZÓ



R.sz.	leírás	
24748	Ø 33 - 83 mm	10
24743	Ø 33 - 103 mm	10

## FESTA

### FÚRÓ



R.sz.	leírás	
24749		50



### SC KÖSZÖRŰ CSEMPÉRE



R.sz.	leírás	
22200	200 mm	20



### SC KÖSZÖRŰ CSEMPÉRE

A téglá csiszolására



R.sz.	leírás	
22201	200 mm kettős érdesség	20

## FESTA

### KÖRKIVÁGÓ - KARBID

· üvegre és kerámiaira  
· hűtés szükséges



R.sz.	leírás	
24770	Ø 4 mm	1
24771	Ø 6 mm	1
24772	Ø 8 mm	1
24773	Ø 10 mm	1
24774	Ø 12 mm	1



### FÚRÓSZÁR MEGVEZETŐ

R.sz.	leírás	
20379	Ø 4, 5, 6, 7, 8, 10, 12 mm	10

**FESTA**

## GYÉMÁNT KÖRKIVÁGÓ

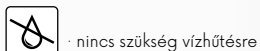
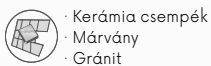
**M14**

R.s.	leírás	üchyt		R.s.	leírás	üchyt	
24760	Ø 6 mm	M14	1	24675	<b>NEW</b> Ø 32 mm	M14	1
24761	Ø 8 mm	M14	1	24766	Ø 35 mm	M14	1
24762	Ø 10 mm	M14	1	24776	<b>NEW</b> Ø 40 mm	M14	1
24763	Ø 12 mm	M14	1	24767	Ø 45 mm	M14	1
24764	Ø 14 mm	M14	1	24791	Ø 50 mm	M14	1
24670	<b>NEW</b> Ø 16 mm	M14	1	24768	Ø 53 mm	M14	1
24671	<b>NEW</b> Ø 18 mm	M14	1	24792	Ø 60 mm	M14	1
24790	Ø 20 mm	M14	1	24793	Ø 65 mm	M14	1
24672	<b>NEW</b> Ø 22 mm	M14	1	24769	Ø 68 mm	M14	1
24673	<b>NEW</b> Ø 25 mm	M14	1	24794	Ø 75 mm	M14	1
24765	Ø 28 mm	M14	1	24796	Ø 83 mm	M14	1
24674	<b>NEW</b> Ø 30 mm	M14	1	24676	<b>NEW</b> Ø 110 mm	M14	1

**NEW****FESTA**

## GYÉMÁNT KÖRKIVÁGÓ

- Ø 8 mm
- Ø 10 mm
- Ø 14 mm
- Ø 22 mm
- Ø 32 mm
- Ø 40 mm
- Ø 68 mm

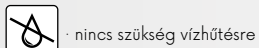
**7x M14**

R.s.	leírás	
24650		1

**FESTA**

## GYÉMÁNT KÖRKIVÁGÓ



R.s.	leírás	
24700	Ø 6 mm	1
24701	Ø 8 mm	1
24702	Ø 10 mm	1
24703	Ø 12 mm	1
24704	Ø 14 mm	1
24705	Ø 20 mm	1

**FESTA**

## GYÉMÁNT KÖRKIVÁGÓ

**6x**

R.s.	leírás	
24798	Ø 6, 8, 10, 12, 14, 20 mm	1

**NEW**

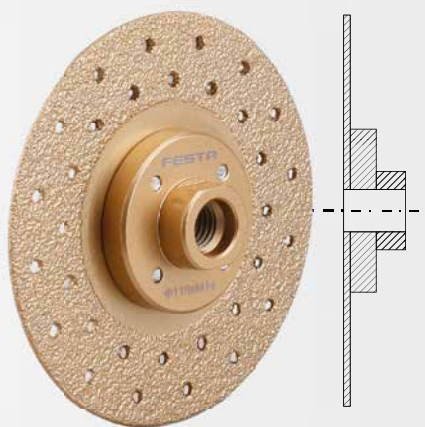

**FESTA**

## GYÉMÁNT CSISZOLÓ VÁGÓTÁRCSA

**M14**

- Kerámia csempék
- Márvány
- Gránit

· nincs szükség vízhűtésre

R.sz.	Leírás	
24655	Ø 115 mm	M14 1

**NEW**

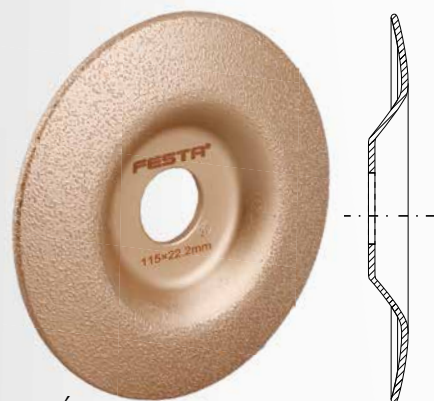

**FESTA**

## GYÉMÁNT CSISZOLÓ VÁGÓTÁRCSA

- Kerámia csempék
- Márvány
- Gránit

· nincs szükség vízhűtésre

R.sz.	Leírás	
24658	Ø 115 mm	Ø 22,2 mm 1

**NEW**

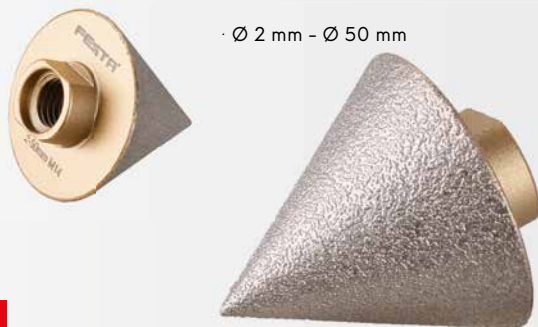

· Ø 2 mm - Ø 50 mm

**FESTA**

## GYÉMÁNT CSISZOLÓ KORONA

**M14**

- Kerámia csempék
- Márvány
- Gránit

· nincs szükség vízhűtésre

R.sz.	Leírás	
24778	Ø 2 - 50 mm	1

**NEW**



· Ø 20 mm - Ø 48 mm

**FESTA**

## GYÉMÁNT CSISZOLÓ KORONA

**M14**

- Kerámia csempék
- Márvány
- Gránit

· nincs szükség vízhűtésre

R.sz.	Leírás	
24779	Ø 20 - 48 mm	1

**FESTA**

## GYÉMÁNT CSISZOLÓ KORONA

**M14**

- Kerámia csempék
- Márvány
- Gránit

· nincs szükség vízhűtésre

R.sz.	Leírás	
24795	Ø 20 x 50 mm	1

**FESTA**

## FÚRÓ ÜVEGHEZ ÉS KERÁMIAHOZ

**TiN**

**1/4"**

- Kerámia csempék
- Üveg

R.sz.	Leírás	
24780	Ø 4 mm	40
24781	Ø 5 mm	40
24782	Ø 6 mm	40
24783	Ø 8 mm	40
24784	Ø 10 mm	40
24785	Ø 12 mm	40
24786	Ø 14 mm	1
24787	Ø 16 mm	1
24788	Ø 18 mm	1
24789	Ø 20 mm	1



**FESTA**

VÉSŐ, LYUKASZTÓ, PONTOZÓ

CrV

12x

- 2, 6, 8 mm
- 10, 12, 16 mm
- Ø 1,5-3-4-5-6-8 mm



R.s. leírás  
19487

4

**FESTA**

VÉSŐ, LYUKASZTÓ, PONTOZÓ

CrV

6x

- 2 x 140, 8 x 115 mm
- 12 x 152, 10 x 142 mm
- Ø 3 x 152, 6 x 152 mm



R.s. leírás  
19486

10



**FESTA**

SPICCVÉSŐ

CrV

R.s. leírás  
19429 200 mm



1



**FESTA**

VÉSŐ KLT.

CrV

3x

- 10, 12, 16 mm



R.s. leírás  
19485

10



**FESTA**

LAPOSVÉSŐ

CrV

R.s.	leírás		
19410	200 mm	20 mm	10
19411	250 mm	25 mm	10
19412	300 mm	25 mm	10
19418	400 mm	25 mm	5
19419	500 mm	25 mm	5



LAPOSVÉSŐ

CrV

R.s. leírás  
19436 200 mm 20 mm 15



**FESTA**

LYUKASZTÓK CRV

CrV 6x

R.sz.	leírás	
19483	Ø 3, 4, 5, 6, 7, 8 mm	5



**FESTA**

LYUKASZTÓK CRV

CrV 6x

R.sz.	leírás	
19482	Ø 3, 4, 5, 6, 8 mm	5



**FESTA**

LYUKASZTÓK

CrV

R.sz.	leírás	
19472	Ø 4 mm 150 mm	1
19473	Ø 5 mm 150 mm	1
19474	Ø 6 mm 150 mm	1



**FESTA**

LYUKASZTÓK CRV

CrV 3x

R.sz.	leírás	
19480	Ø 0.8, 1.5, 2.5 mm	10



**FESTA**

PONTOZÓ

CrV

R.sz.	leírás	
19477	Ø 2,5 mm	20



**FESTA**

PONTOZÓK CRV

CrV 3x

R.sz.	leírás	
19481	Ø 0.8, 1.5, 2.5 mm	10



**FESTA**

AUTOMATA PONTOZÓ

CrV

R.sz.	leírás	
19478	Ø 2,5 mm	12



RS-G ÜVEGVÁGÓ



R.sz.	leírás	
20350	130 mm	12

**FESTA**

CSIGAFÚRÓ FÁHOZ



R.s.	leírás		R.s.	leírás	
20980	Ø 6 x 230 mm	1	20984	Ø 16 x 230 mm	1
20957	Ø 6 x 300 mm	1	20899	Ø 16 x 300 mm	1
20981	Ø 8 x 230 mm	1	20917	Ø 16 x 450 mm	1
20958	Ø 8 x 300 mm	1	20922	Ø 16 x 600 mm	1
20982	Ø 10 x 230 mm	1	20918	Ø 18 x 450 mm	1
20896	Ø 10 x 300 mm	1	20923	Ø 18 x 600 mm	1
20913	Ø 10 x 450 mm	1	20919	Ø 20 x 450 mm	1
20983	Ø 12 x 230 mm	1	20924	Ø 20 x 600 mm	1
20897	Ø 12 x 300 mm	1	20724	Ø 22 x 450 mm	1
20915	Ø 12 x 450 mm	1	20725	Ø 24 x 450 mm	1
20920	Ø 12 x 600 mm	1	20726	Ø 26 x 450 mm	1
20898	Ø 14 x 300 mm	1	20727	Ø 28 x 450 mm	1
20916	Ø 14 x 450 mm	1	20728	Ø 30 x 450 mm	1
20921	Ø 14 x 600 mm	1			

**FESTA**

CSIGAFÚRÓ FÁHOZ

**5x**

R.s.	leírás	
20911	Ø 8, 10, 12, 14, 16 x 460 mm	10

**FESTA**

CSIGAFÚRÓ FÁHOZ

**6x**

R.s.	leírás	
20912	Ø 6, 8, 10, 12, 16, 20 x 230 mm	10



FAFÚRÓ



R.s.	leírás		R.s.	leírás		R.s.	leírás	
20729	Ø 6 x 400 mm	1	20732	Ø 12 x 400 mm	1	20734	Ø 16 x 400 mm	1
20731	Ø 8 x 400 mm	1	20738	Ø 12 x 600 mm	1	20740	Ø 16 x 600 mm	1
20736	Ø 8 x 600 mm	1	20733	Ø 14 x 400 mm	1	20735	Ø 18 x 400 mm	1
20730	Ø 10 x 400 mm	1	20739	Ø 14 x 600 mm	1	20741	Ø 18 x 600 mm	1
20737	Ø 10 x 600 mm	1						



FAFÚRÓ



R.s.	leírás	
21440	Ø 4 x 75 mm	1
21441	Ø 5 x 85 mm	1
21442	Ø 6 x 90 mm	1
21443	Ø 7 x 105 mm	1
21444	Ø 8 x 115 mm	1
21445	Ø 9 x 120 mm	1
21446	Ø 10 x 120 mm	1

FAFÚRÓ KÉSZLET



R.s.	leírás	
20910	8 db Ø 3, 4, 5, 6, 7, 8, 9, 10 mm	10
20905	5 db Ø 4, 5, 6, 8, 10 mm	10



## MARÓ FÚRÓSZÁR

HSS TiN



R.s.	leírás	
20460	Ø 6 mm	50



## MARÓ FÚRÓKÉSZLET

HSS TiN



6x

R.s.	leírás	
20450	Ø 3, 4, 5, 6, 6.5, 8 mm	20

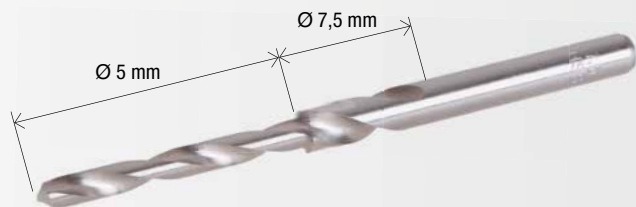

## FESTA

### FÚRÓ, MEGERŐSÍTÉSEKHEZ

HSS

R.s.	leírás	
20210	Ø 7.5, 5 mm	1

## HOMLOKMARÓ FAFÚRÓ KLT.



6x

R.s.	leírás	
20901	Ø 10, 12, 16, 18, 20, 25 mm	20

## PÁNTKIVETŐ KLT.



5x

R.s.	leírás	
21530	Ø 15, 20, 25, 30, 35 mm Ø 8 mm	20



## FÚRÓ-MARÓ KLT.



5x

R.s.	leírás	
21450	Ø 8 mm	1



## FÚRÓ-MARÓ KLT.



12x

R.s.	leírás	
21451	Ø 8 mm	1



## FÚRÓ-MARÓ KLT.



24x

R.s.	leírás	
21452	Ø 8 mm	1



FÚRÓ-MARÓ KLT.



35x

R.s. leírás  
21453 Ø 8 mm



1



FÚRÓ-MARÓ KLT.



59x

R.s. leírás  
21454 Ø 8 mm



1



PROFILMARÓ KLT.

6 mm 12 mm

5x

R.s. leírás  
21541



25



CSAPOSKÓ KLT.

5x

R.s. leírás  
21540 Ø 3 mm, 6 mm



12



CSISZOLÓ KLT. FÚRÓBA

100x

R.s. leírás  
24755



5



CSISZOLÓ KLT. FÚRÓBA

150x

R.s. leírás  
24756



10



**NEW**



· Ø 19 - 127 mm

**FESTA**

**KORONA FÚRÓSZÁR - ÁLLÍTHATÓ**



R.sz.	Leírás		
24415	Ø 19 - 127 mm	max. hloubka 29 mm	6

**FESTA**

**KÖRKIVÁGÓ - KLT.**

- Ø 19 mm
- Ø 22 mm
- Ø 25,5 mm
- Ø 36 mm
- Ø 44 mm

- Ø 51 mm
  - Ø 60 mm
  - Ø 67 mm
  - Ø 76 mm
  - Ø 82 mm
- inbus  
2x fej



**12x**

R.sz.	leírás		
24712	6 tpi		20



**FESTA**

**KÖRKIVÁGÓ - KLT.**

- Ø 64 mm
- Ø 73 mm
- Ø 89 mm
- Ø 102 mm
- Ø 127 mm

inbus  
fej



**8x**

R.sz.	leírás		
24706	6 tpi		20



**FESTA**

### KÖRKIVÁGÓ FÁRA ÉS GIPSZKARTONRA



R.sz.	leírás	
24715	1' Ø 67 mm 6 tpi	5
24713	1' Ø 73 mm 6 tpi	5
24714	1' Ø 102 mm 6 tpi	5
24720	1' Ø 152 mm 6 tpi	5

### KÖRKIVÁGÓ - KLT.



R.sz.	leírás	
24721	1' Ø 26, 32, 38, 45, 50, 56, 63 mm	10
24722	2' Ø 26, 32, 38, 45, 50, 56, 63 mm	10



### KÖRKIVÁGÓ ÁLLÍTHATÓ



R.sz.	leírás	
24716	Ø 30 - 120 mm	5

### KÉZIFÚRÓ KLT.

**HOBBY****4x**

R.sz.	leírás	
20381	Ø 2, 3, 4, 5 mm	20



### ADAPTER SDS MAX / SDS +



R.sz.	leírás	
20744		1

### ADAPTER SDS+ / 1/2 UNF



R.sz.	leírás	
20745		1



**FESTA**

## SZORÍTÓ TOKMÁNY

1/2"



R.sz.	leírás	
20960	1-13 mm + 2 klicse, 1/2 - 20 UNF	3
20966	náhradni klicsek	25



**FESTA**

## GYORSBEFOGÓ TOKMÁNY

1/2"



R.sz.	leírás	
20965	1,5 - 13 mm 1/2' - 20 UNF	1



## GYORSBEFOGÓ TOKMÁNY

1/2"



R.sz.	leírás	
20961	1,5 - 13 mm 1/2' - 20 UNF	1



## TOLDAT 90° FÚRÓGÉPBE

R.sz.	leírás	
20365	Ø 1,0 - 10 mm	10



## GYORSBEFOGÓ TOKMÁNY BITBEFOGÁSRA

1/4"



R.sz.	leírás	
20963	Ø 1 - 6 mm	10



## SZÁM BEÚTÓ

R.sz.	leírás	
20972	6 mm	5
20973	8 mm	5



## LYUKASZTÓ

13x



R.sz.	leírás	
24695	Ø 5, 6, 8, 10, 11, 13, 16, 19, 22, 25, 28, 32, 35 mm	5



## LYUKASZTÓ

24690 - Ø 2,5 mm	24691 - Ø 2mm
Ø 3 mm	Ø 2,5 mm
Ø 4 mm	Ø 3,2 mm
Ø 5 mm	Ø 4 mm
Ø 6 mm	Ø 4,8 mm
Ø 7 mm	Ø 5 mm
Ø 8 mm	Ø 6,4 mm
Ø 9 mm	Ø 8 mm
Ø 10 mm	Ø 9,5 mm
	Ø 11,1 mm
	Ø 12,7 mm
	Ø 14 mm
	Ø 15,8 mm
	Ø 19 mm
	Ø 22 mm

R.sz.	leírás	
24690	9 db Ø 2,5 - 10 mm	10
24691	15 db Ø 2 - 22 mm	5



## BETŰ BEÚTÓ

R.sz.	leírás	
20970	6 mm	5
20971	8 mm	5

**FESTA®****KÖRKEFE**

20mm

**FESTA®****KÖRKEFE DÖNTÖTT**

· sárgaréz bevonattal

**M14**

R.sz.	leírás	huzal	
21900	Ø 100 mm M14	s 0,3	60
21902	Ø 125 mm M14	s 0,3	42



10mm

**FESTA®****KÖRKEFE DÖNTÖTT**

· sárgaréz bevonattal

**M14**

R.sz.	leírás	huzal	
22001	Ø 100 mm M14	s 0,3	60
21901	Ø 125 mm M14	s 0,3	42

**FESTA®****KÖRKEFE DÖNTÖTT**

· sárgaréz,

**M14**

R.sz.	leírás	huzal	
21920	Ø 100 mm M14	s 0,3	60

**FESTA®****FAZÉKKEFE**

· sárgaréz bevonattal

**M14**

R.sz.	leírás	huzal	
21903	Ø 65 mm M14	s 0,3	60
22002	Ø 75 mm M14	s 0,3	80
21904	Ø 85 mm M14	s 0,3	60
22003	Ø 100 mm M14	s 0,3	36
21905	Ø 125 mm M14	s 0,3	24
21906	Ø 150 mm M14	s 0,3	12

**FESTA®****FAZÉKKEFE**

· sárgaréz,

**M14**

R.sz.	leírás	huzal	
21925	Ø 75 mm M14	0,3 mm	80
21926	Ø 100 mm M14	0,3 mm	36

**FESTA®****KÖRKEFE + HÉZAGOLÓ GYÜRÜK**

· sárgaréz bevonattal

· redukciós tárosák



R.sz.	leírás	huzal	
22007	Ø 100 mm Ø 20 mm	s 0,3	60
22008	Ø 125 mm Ø 20 mm	s 0,3	42
22009	Ø 150 mm Ø 32,2 mm	s 0,3	32
22010	Ø 175 mm Ø 32,2 mm	s 0,3	20
22011	Ø 200 mm Ø 32,2 mm	s 0,3	20



**FESTA**

**FAZÉKKEFE SODROTT**

· edzett

**M14**



R.s.	leírás	huzal	csomagolás
22004	Ø 65 mm M14	s 0,3	60
22005	Ø 75 mm M14	s 0,3	24
22006	Ø 100 mm M14	s 0,3	24
21907	Ø 125 mm M14	s 0,3	24
21908	Ø 150 mm M14	s 0,3	12



**FESTA**

**FAZÉKKEFE SODROTT**

· edzett

**INOX M14**



R.s.	leírás	huzal	csomagolás
22037	Ø 65 mm M14	s 0,5	60
22038	Ø 80 mm M14	s 0,5	24



**FESTA**

**KÖRKEFE SODROTT SAROKCSISZOLÓRA**

· edzett

**M14**



R.s.	leírás	huzal	počet copů	csomagolás
21911	Ø 100 mm M14	s 0,5	30	60
21912	Ø 115 mm M14	s 0,5	32	42
21913	Ø 125 mm M14	s 0,5	36	42
21914	Ø 150 mm M14	s 0,5	40	32



**FESTA**

**KÖRKEFE SODROTT SAROKCSISZOLÓRA**

· edzett

**M14**



R.s.	leírás	huzal	csomagolás
22012	Ø 100 mm M14	s 0,5	60
22013	Ø 115 mm M14	s 0,5	42
22014	Ø 125 mm M14	s 0,5	42
22015	Ø 150 mm M14	s 0,5	32
22016	Ø 178 mm M14	s 0,5	20



**FESTA**

**KÖRKEFE SODROTT SAROKCSISZOLÓRA**

· edzett

**INOX M14**



R.s.	leírás	huzal	csomagolás
22039	Ø 100 mm M14	s 0,5	60
22040	Ø 125 mm M14	s 0,5	42



**FESTA**

**KÖRKEFE SODROTT DÖNTÖTT**

· edzett

**M14**



R.s.	leírás	huzal	csomagolás
22017	Ø 100 mm M14	s 0,5	60
21909	Ø 115 mm M14	s 0,5	42
21910	Ø 125 mm M14	s 0,5	42



Ø 6 mm

**FESTA**

**KÖRKEFE CSAPOS, SODROTT**

· edzett



R.s.	leírás	huzal	csomagolás
22023	Ø 75 mm	s 0,5	10



Ø 6 mm

**FESTA**

**FAZÉKKEFE CSAPOS, SODROTT**

· edzett



R.s.	leírás	huzal	csomagolás
22024	Ø 75 mm	s 0,5	12



Ø 6 mm

**FESTA**

**KÖRKEFE CSAPOS DÖNTÖTT**

· edzett



R.s.	leírás	huzal	csomagolás
22025	Ø 75 mm	s 0,5	12

Ø 6 mm



Ø 6 mm



Ø 6 mm

**FESTA****KÖRKEFE CSAPOS**

· sárgaréz bevonattal

R.s.	leírás	huzal	
22026	Ø 50 mm	s 0,3	15
22027	Ø 63 mm	s 0,3	15
22028	Ø 75 mm	s 0,3	10
22029	Ø 100 mm	s 0,3	15

**FESTA****FAZÉKKEFE CSAPOS**

· sárgaréz bevonattal

R.s.	leírás	huzal	
22030	Ø 65 mm	s 0,3	12
22031	Ø 75 mm	s 0,3	12

**FESTA****ECSETKEFE SODROTT**

· edzett

R.s.	leírás	huzal	
22021	Ø 19 mm	s 0,5	30
22022	Ø 22 mm	s 0,5	25



Ø 6 mm



Ø 6 mm

**FESTA****ECSETKEFE**

R.s.	leírás	huzal	
22058	Ø 12 mm	s 0,3	25
22059	Ø 25 mm	s 0,3	25

**FESTA****ECSETKEFE**

· sárgaréz bevonattal

R.s.	leírás	huzal	
22018	Ø 12 mm	s 0,3	15
22019	Ø 17 mm	s 0,3	15
22020	Ø 25 mm	s 0,3	25

**FESTA****KÖRKEFE NYLON**

R.s.	leírás	huzal	
21930	Ø 125 mm	M14 1,2 mm	10
21931	Ø 150 mm	M14 1,2 mm	15

**FESTA****FAZÉKKEFE NYLON**

R.s.	leírás	huzal	
21940	Ø 75 mm	M14 1,2 mm	1
21941	Ø 100 mm	M14 1,2 mm	1

Ø 6 mm

**FESTA****KÖRKEFE NYLON CSAPOS**

R.s.	leírás	huzal	
21935	Ø 50 mm	1,2 mm	15
21936	Ø 75 mm	1,2 mm	10
21937	Ø 100 mm	1,2 mm	15

Ø 6 mm

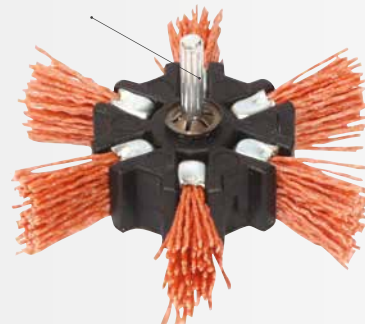
**FESTA****POLÍR KÖRKEFE CSAPOS**

R.s.	leírás	huzal	
22032	Ø 100 mm	1,2 mm	12



## DRÓT ECSET

R.sz.	leírás	huzal	
22158	200 mm	ocel	1
22159	200 mm	mosaz	1



## DRÓTKEFE MŰA.NYELŰ

R.sz.	leírás	huzal	
22035	270 mm	ocel	24
22036	270 mm	neréz	24



## DRÓTKEFE

R.sz.	leírás	soros	
22033	300 mm	4 soros	12
22034	300 mm	5 soros	12



## BRONZSZÁLAS DRÓTKEFE, FÁRA

· sárgaréz bevonattal

R.sz.	soros	
22078	3 soros	20



## BRONZSZÁLAS DRÓTKEFE, FÁRA

· sárgaréz bevonattal

R.sz.	leírás	soros	
22079	300 mm	4 soros	6



**FESTA**

## DRÓTKEFE MŰA.NYELŰ

R.sz.	leírás	soros	
22080	270 mm	5 soros	12



**FESTA**

## DRÓTKEFE MŰA.NYELŰ

R.sz.	leírás	soros	
22082	300 mm	5 soros	12



## BRONZ ÉS FÉM SZÁLAS DRÓTKEFE KÉSZLET

3x



R.sz.	soros	
22081	3 soros	12



**FESTA**

## BRONZ ÉS FÉM SZÁLAS DRÓTKEFE KÉSZLET

· Nylon, acél, sárgaréz

3x



R.sz.	leírás	
22086	180 mm	12

**FESTA****GYÉMÁNT POLÍROZÓ TÁRCSA Ø 100 MM, TÉPOZARRAL**

- Kerámia csempék
- üveg
- Márvány
- Gránit



R.s.	érdesség	
22701	50	1
22702	100	1
22703	200	1
22704	400	1
22705	800	1
22706	1500	1
22707	3000	1

**FESTA****GUMITÁNYÉR CSAPOS**

- M14 | Ø 8 mm
- EVA 10 mm

**M14**

R.s.	leírás	
22062	Ø 115 mm	25
22063	Ø 125 mm	25
22064	Ø 150 mm	10

**FESTA****CSISZOLÓTÁNYÉR MENE-  
TES FIBERTÁRCSÁHOZ**

**NORTON** MADE IN EU  
SAINT-GOBAIN

**M14**

R.s.	leírás	
22073	Ø 125 mm, M14	1
22074	Ø 150 mm, M14	1

**FESTA****GUMITÁNYÉR**

- sarokcsiszolókhöz

**M14**

R.s.	leírás	
22043	Ø 100 mm tépózár	1

**GUMITÁNYÉR**

- sarokcsiszolókhöz

**M14**

R.s.	leírás	
22044	Ø 125 mm M14 tépózár	15
22060	Ø 150 mm M14 tépózár	6

**ADAPTER****M14**

R.s.	leírás	
22087		1

**GUMITÁNYÉR CSAPOS**

R.s.	leírás	stopka   shank	
22061	Ø 125 mm tépózár	Ø 8 mm	6

**GUMITÁNYÉR CSAPOS**

R.s.	leírás	
22041	Ø 125 mm bind with screw	11
22042	Ø 125 mm tépózár	11





## POLÍROZÓKORONG TÉPŐZÁRAS



R.sz.	leírás	leírás	
22065	Ø 125 mm	tépőzár	20
22066	Ø 150 mm	tépőzár	20



## POLÍROZÓKORONG



R.sz.	leírás	leírás	
22068	Ø 125 mm		20
22069	Ø 150 mm		20

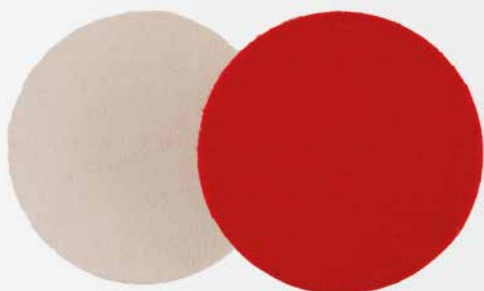

## POLÍROZÓKORONG TÉPŐZÁRAS



R.sz.	leírás	leírás	
22070	Ø 115 mm		20
22071	Ø 125 mm	tépőzár	20
22072	Ø 150 mm		20



Ø 6 mm

## NYLON TÁRCSA, CSISZOLÓ



R.sz.	leírás	leírás	
22091	Ø 50 mm	P240	1
22092	Ø 75 mm	P240	1
22093	Ø 100 mm	P240	1



## KÖRKEFE NYLON



R.sz.	leírás	
21798	Ø 125 mm Ø 22,2 mm	1



Ø 6 mm

## KÖRKEFE NYLON



R.sz.	leírás	leírás	
22088	Ø 65 mm		9
22090	Ø 100 mm		5



## KÖRKEFE NYLON



R.sz.	leírás	
22083	Ø 115 mm Ø 22,2 mm	10
22084	Ø 125 mm Ø 22,2 mm	10
22085	Ø 150 mm Ø 22,2 mm	10



## KÖRKEFE NYLON



R.sz.	leírás	
22095	Ø 178 mm	1

**FESTA**

FIBER TÁRCSA - Ø 125 MM

3x



R.s.	érdesség	
22160	P40	1
22161	P60	1
22162	P80	1
22163	P100	1
22164	P120	1

**FESTA**

FIBER TÁRCSA - Ø 150 MM

3x



R.s.	érdesség	
22166	P60	1
22167	P80	1
22168	P100	1

**FESTA**

CSISZOLÓTÁRCSA TÉPŐZÁRAS Ø 150 MM

3x



R.s.	érdesség	
22045	P40	1
22046	P60	1
22047	P80	1
22048	P100	1
22049	P120	1
22050	P150	1
22051	P180	1
22052	P220	1

**FESTA**

CSISZOLÓTÁRCSA TÉPŐZÁRAS Ø 125 MM

3x



R.s.	érdesség	
22053	P40	1
22054	P60	1
22055	P80	1
22056	P100	1
22057	P120	1

**FESTA**VIBRÁCIÓS CSISZOLÓ  
94 X 94 X 94 MM

5x



R.s.	érdesség	
21831	P60	1
21832	P80	1
21834	P120	1

CSISZOLÓTÁRCSA  
TÉPŐZÁRAS Ø 125 MM

3x

R.s.	érdesség	
22096	P40	20
22097	P60	20
22098	P80	20
22099	P120	20

**FESTA**VÉGTELEN CSISZOLÓSZALAG  
- 75 X 533 MM

3x



R.s.	érdesség	
21810	P40	20
21811	P60	20
21812	P80	20
21813	P100	20
21814	P120	20



## CSISZOLÓVÁSZON 93 X 230 MM

5x



R.sz.	érdesség	počet otvů	
21740	P40	8	20
21741	P60	8	20
21742	P80	8	20
21743	P100	8	20
21744	P120	8	20



## CSISZOLÓVÁSZON 115 X 280 MM

5x



R.sz.	érdesség	počet otvů	
21750	P40	10	20
21751	P60	10	20
21752	P80	10	20
21753	P100	10	20
21754	P120	10	20



## CSISZOLÓVÁSZON 230X280 MM

10x

R.sz.	érdesség	
21732	P40	1
21734	P60	1
21735	P80	1
21736	P100	1
21737	P120	1

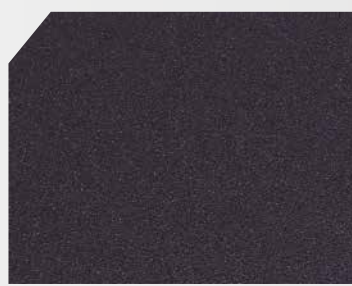

## CSISZOLÓPAPÍR VÍZÁLLÓ 230X280 MM

10x

R.sz.	érdesség	
21701	P60	1
21702	P80	1
21703	P100	1
21704	P120	1
21705	P150	1
21706	P180	1
21709	P240	1



## CSISZOLÓPAPÍR 230X280 MM

10x

R.sz.	érdesség	
21715	P40	1
21716	P60	1
21717	P80	1
21718	P100	1
21719	P120	1
21720	P150	1
21721	P180	1
21724	P240	1



**FESTA**

## CSISZOLÓ TUSKÓ

gyors fogás

R.sz.	leírás	
22067	170 x 70 mm	10



## CSISZOLÓ TUSKÓ



R.sz.	leírás	
22075	210 x 105 mm	100
22076	160 x 85 mm	100



## CSISZOLÓ TUSKÓ

R.sz.	leírás	
22077	125 x 68 mm	10

**FESTA****GYÉMÁNTCSISZOLÓ SZIVACS**

- 90 x 55 x 25 mm
- Kerámia csempék
- üveg
- Márvány
- Gránit



R.sz.	érdesség	
22115	P60	10
22116	P120	10
22117	P200	10

**CSISZOLÓLAPÁT TÁRCSA**

R.sz.	érdesség	leírás	
21850	P40		1
21851	P60		1
21852	P80	20 x 20, Ø 6 mm	1
21853	P100		1
21854	P120		1
21855	P40		1
21856	P60		1
21857	P80	30x30, Ø 6mm	1
21858	P100		1
21859	P120		1
21860	P40		1
21861	P60		1
21862	P80	60x30, Ø 6mm	1
21863	P100		1
21864	P120		1

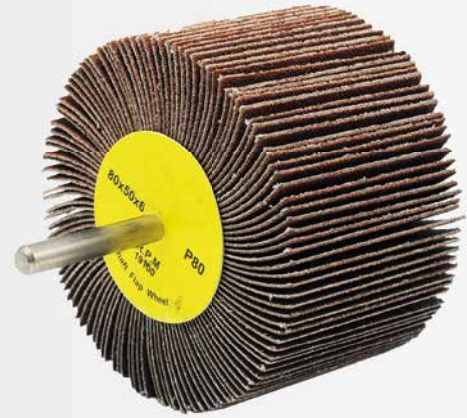
**FESTA****CSISZOLÓ SZIVACS 100 X 70 X 28 MM - LESARKÍTOTT**

R.sz.	érdesség	
22106	P 60	10
22107	P 80	10
22108	P 100	10
22109	P 120	10

**FESTA****CSISZOLÓ SZIVACS 100 X 70 X 25 MM**

R.sz.	érdesség	
22100	P60	20
22101	P80	20
22102	P100	20
22103	P120	20
22104	P180	20
22105	P220	20

**FESTA****CSISZOLÓ SZIVACS 120 X 95 X 10 MM**

R.sz.	érdesség	
22110	P80	20
22111	P120	20
22112	P180	20
22113	P220	20



## SZERSZÁMOK A GIPSZKARTONHOZ



### GIPSZKARTON GYALU

R.sz.	leírás	
22120	250 x 40 mm	10



### GIPSZKARTON GYALU

R.sz.	leírás	
22121	250 x 40 mm	10
22122	140 x 40 mm	6



### GIPSZKARTON GYALU

R.sz.	leírás	
22126	155 x 40 mm	1



### GIPSZKARTON GYALU

R.sz.	leírás	
22125	Ø 250 x 40 mm	6



### GIPSZKARTON GYALU

R.sz.	leírás	
22124	Ø 250 x 16 mm	10



### GIPSZKARTON GYALU

R.sz.	leírás	
22123	60 x 40 mm	6



### FESTA GIPSZKARTON FÚRÉS

R.sz.	leírás	
24159	150 mm	12

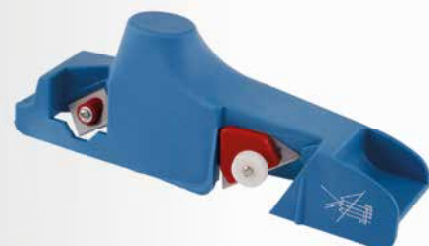

### GIPSZKARTON GYALU

R.sz.	leírás	
34315		10
34316	náhradní břit	1



### GIPSZKARTON LYUKFÚRÓ

R.sz.	leírás	
24190	270 mm	10

### TART. KÉSEK GIPSZKART. GYALUHOZ

R.sz.	leírás	
22130	250 x 40 mm	20
22129	155 x 40 mm	20
22132	140 x 40 mm	20
22133	60 x 40 mm	20
22134	Ø 16 x 250 mm	20



## RÁSPOLY ÉS FÁJLOK

**FESTA**

## NÉGYSZÖGŰ FÉMRESZELŐ



R.sz.	leírás	érdesség	
22184	250 mm	2	10

**FESTA**

## HÁROMSZÖGŰ FÉMRESZELŐ



R.sz.	leírás	érdesség	
22183	250 mm	2	10

**FESTA**

## HÁROMSZÖGŰ RESZELŐ



R.sz.	leírás	érdesség	
22178	150 mm	1	10

**FESTA**

## FÉMRESZELŐ KÉSZLET

**5x**

R.sz.	leírás	érdesség	
22209	150 mm	2	10
22186	250 mm	2	5

**FESTA**

## LAPOS FÉMRESZELŐ



R.sz.	leírás	érdesség	
22206	150 mm	2	10
22180	250 mm	2	10

**FESTA**

## FÉLGÖMBÖLYŰ FÉMRESZELŐ



R.sz.	leírás	érdesség	
22207	150 mm	2	10
22182	250 mm	2	10

**FESTA**

## GÖMBÖLYŰ FÉMRESZELŐ



R.sz.	leírás	érdesség	
22181	250 mm	2	10

**FESTA**

## FÉMRESZELŐ KÉSZLET

**3x**

R.sz.	leírás	érdesség	
22208	150 mm	2	10
22185	250 mm	2	5



**FESTA**

RÁSPOLY



R.sz.	leírás	
22202	150 mm	10
22197	300 mm	10



**FESTA**

RÁSPOLY



R.sz.	leírás	
22204	150 mm	10
22205	250 mm	10
22198	300 mm	10

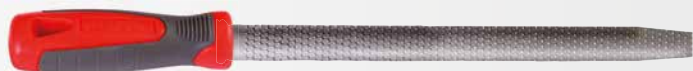

**FESTA**

RÁSPOLY



R.sz.	leírás	
22203	150 mm	6
22199	300 mm	6



**FESTA**

RÁSPOLY KÉSZLET



3x



R.sz.	leírás	
22195	300 mm	5



**FESTA**

LÁNCFŰRÉSZ RESZELŐ



R.sz.	leírás		R.sz.	leírás	
22170	200 mm 3,5 mm	10	22173	200 mm 5 mm	10
22171	200 mm 4 mm	10	22174	200 mm 5,5 mm	10
22172	200 mm 4,5 mm	10			



**FESTA**

TŰRESZELŐ

10x



R.sz.	leírás	
22188		20



**FESTA**

LÁNCFŰRÉSZ RESZELŐ ADAPTER



R.sz.	leírás	
22190	300 mm	5



**FESTA**

GYÉMÁNT RESZELŐ

10x



R.sz.	leírás	
22189		25

**FESTA®**

R.s.	leírás	r. fogú	
	<b>Ø 115 mm</b>		
22300	Ø 115 x 22 mm	40	1
	<b>Ø 125 mm</b>		
22301	Ø 125 x 22 mm	40	1
	<b>Ø 140 mm</b>		
22302	Ø 140 x 20 mm	24	1
22303	Ø 140 x 20 mm	30	1
	<b>Ø 150 mm</b>		
22305	Ø 150 x 20 mm	24	1
	<b>Ø 160 mm</b>		
22307	Ø 160 x 20 mm	18	1
22309	Ø 160 x 20 mm	24	1
22310	Ø 160 x 20 mm	30	1
22311	Ø 160 x 20 mm	36	1
22312	Ø 160 x 20 mm	48	1
22313	Ø 160 x 20 mm	60	1
	<b>Ø 165 mm</b>		
22314	Ø 165 x 20 mm	24	1
	<b>Ø 180 mm</b>		
22315	Ø 180 x 30 mm	24	1
22317	Ø 180 x 30 mm	50	1
22318	Ø 180 x 20 mm	50	1
	<b>Ø 190 mm</b>		
22319	Ø 190 x 20 mm	40	1
22320	Ø 190 x 30 mm	40	1
	<b>Ø 200 mm</b>		
22322	Ø 200 x 30 mm	24	1
22324	Ø 200 x 30 mm	40	1
22326	Ø 200 x 30 mm	60	1
	<b>Ø 205 mm</b>		
22328	Ø 205 x 30 mm	40	1
22329	Ø 205 x 30 mm	60	1
	<b>Ø 210 mm</b>		
22332	Ø 210 x 30 mm	40	1
22333	Ø 210 x 30 mm	60	1
	<b>Ø 250 mm</b>		
22335	Ø 250 x 30 mm	40	1
22337	Ø 250 x 30 mm	60	1
	<b>Ø 300 mm</b>		
22340	Ø 300 x 30 mm	40	1
22343	Ø 300 x 30 mm	60	1
22345	Ø 300 x 30 mm	96	1
	<b>Ø 350 mm</b>		
22350	Ø 350 x 30 mm	40	1
22351	Ø 350 x 30 mm	54	1
	<b>Ø 400 mm</b>		
22355	Ø 400 x 30 mm	40	1
22357	Ø 400 x 30 mm	60	1
	<b>Ø 500 mm</b>		
22365	Ø 500 x 30 mm	60	1
	<b>Ø 600 mm</b>		
22370	Ø 600 x 30 mm	60	1

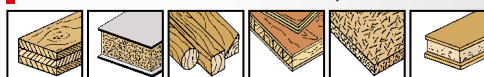
**FESTA**
**KÖRFŰRÉSZ TÁRCSA, VIDIA LAPPAL TCT**

**■ SZŰKÍTŐ GYŰRŰ**

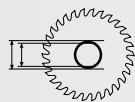
R.s.	leírás	
22399	Ø 20   16 mm	1
22398	Ø 30   25 mm	1





























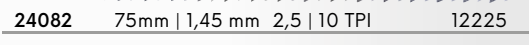







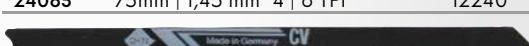

## PROFI DEKOPIRFŰRÉSZLAPOK NÉMETORSZÁGBAN GYÁRTOTT LÉZERKIÉGETÉSES TECHNOLOGIÁVAL



### DEKOPIRFŰRÉSZ LAPOK, HSS (AEG, BOSCH, FESTO, MAKITA, METABO)

	24060	50mm/1mm	0,7 mm/ 36TPI	31007	5 db	10	
	24061	50mm/1mm	1,2 mm/ 21TPI	31012	5 db	10	
	24062	50mm/1mm	2,0 mm/ 13TPI	31020	5 db	10	
	24063	75mm/1mm	3,0 mm/ 8TPI	31030	5 db	10	
	24064	100mm/1mm	1,2 mm/ 21TPI	31112	5 db	10	
	24065	100mm/1,3mm	2,0 mm/ 13TPI	31112	5 db	10	
	24066	75mm/1,45mm	2,0 mm/ 13TPI	31220	5 db	10	
	24067	120mm/1,3mm	1,8 - 2,4 mm/ 10 - 14 TPI	31220	5 db	10	
	24068	75mm/1,45mm	2,5 mm/ 10 TPI	32225	5 db	10	
	24069	75mm/1,45mm	4 mm/ 6 TPI	32240	5 db	10	
	24070	75mm/1,3mm	4 mm/ 6 TPI	32340	5 db	10	
	24071	75mm/1,3mm	4 mm/ 6 TPI	32440	5 db	10	
	24072	75mm/1,45mm	2,5 mm/ 10 TPI	32625	5 db	10	
	24073	85mm/1,45mm	3 mm/ 8 TPI	32730	5 db	10	
	24074	85mm/1,45mm	4 mm/ 6 TPI	32730	5 db	10	
	32825	75mm/1,45mm	2,5   1,2 mm/10   21 TPI	32825	5 db	10	
	24076	75mm/1,7mm	4 mm   6 TPI	32940	5 db	10	
	24077	120mm/1,3mm	4 mm   6 TPI	32040	5 db	10	
	24078	105mm/1,45mm	4 mm   6 TPI	34040	5 db	10	
	24055	55mm	karbid		5 db	1	

## DEKOPIRFŰRÉSZ LAPOK, HSS (BLACK &amp; DECKER, SKIL)

	<b>24080</b>	50mm   1,0 mm	1,2   21 TPI	11012	5 db	10	   
	<b>24081</b>	75mm   1,0 mm	3,0   8 TPI	11030	5 db	10	   
	<b>24082</b>	75mm   1,45 mm	2,5   10 TPI	12225	5 db	10	   
	<b>24083</b>	75mm   1,45 mm	4   6 TPI	12240	5 db	10	   
	<b>24084</b>	75mm   1,3 mm	4   6 TPI	12340	5 db	10	  
	<b>24085</b>	50mm   1,0 mm	2,0   13 TPI	12420	5 db	10	  
	<b>24086</b>	75mm   1,3 mm	4,0   6 TP	12440	5 db	10	  
	<b>24087</b>	75mm   1,45 mm	2,5   10 TPI	12625	5 db	10	  

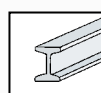

Lágy acél (alacsony szénttartalommal)



Acéllemez

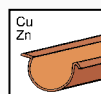

Nem vastartalmú fémek



Kemény- és puhafa

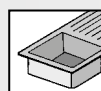

Rozsdamentes acél

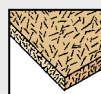

Forgácsdeszka

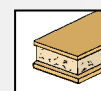

Fóliakaszított deszka

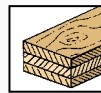

Funérlemez

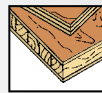

Lecses furnélemez

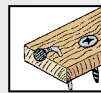

Szögsléc

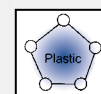

Műanyagok – plasztok

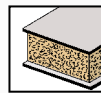

Szendvicsanyag



csempére, kerámiához

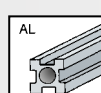

Aluminium

## DEKOPIRFŰRÉSZ LAP ÁLLVÁNY

· állva pengével 24098 - 24060	· 5 db
24080	· 5 db
24061	· 5 db
24062	· 5 db
24081	· 5 db
24063	· 5 db
24066	· 5 db
24067	· 5 db
24082	· 5 db
24068	· 5 db
24083	· 5 db
24069	· 5 db
24084	· 5 db
24070	· 5 db
24086	· 5 db
24071	· 5 db
24087	· 5 db
24072	· 5 db
24073	· 5 db
24074	· 5 db
24075	· 5 db
24076	· 5 db



## SZÚRÓFŰRÉSZ LAP KLT.



5x



R.sz.	leírás	db
24045	készlet	50

R.sz.	leírás	db
24099	64 x 50 cm - állvány	1
24098	64 x 50 cm - állva pengével	1

**FESTA**

ORRFÚRÉSZ LAPOK

HCS 3x

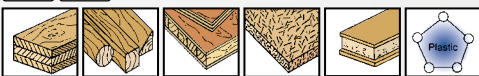

R.sz. 24301 leírás 150 x 19 x 1,3 mm TPI 6

1

**FESTA**

ORRFÚRÉSZ LAPOK

HCS 3x

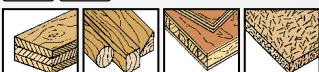

R.sz. 24302 leírás 225 x 19 x 1,3 mm TPI 3

1

**FESTA**

ORRFÚRÉSZ LAPOK

HCS 3x

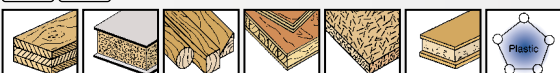

R.sz. 24303 leírás 200 x 19 x 1,3 mm TPI 6 - 10

1

**FESTA**

ORRFÚRÉSZ LAPOK

HCS 3x

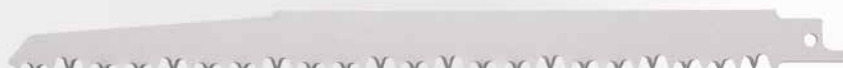
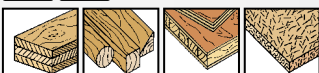

R.sz. 24304 leírás 240 x 19 x 1,5 mm TPI 5

1

**FESTA**

ORRFÚRÉSZ LAPOK

Bi Metal 3x

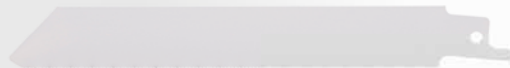
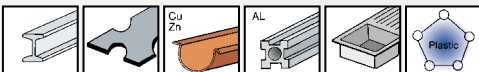

R.sz. 24305 leírás 150 x 19 x 1 mm TPI 24

1

**FESTA**

ORRFÚRÉSZ LAPOK

Bi Metal 3x

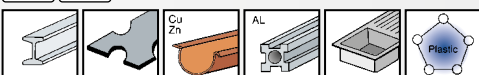

R.sz. 24306 leírás 150 x 19 x 1 mm TPI 9

1

**FESTA**

## ORRFŰRÉSZ LAPOK

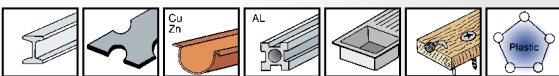
Bi  
Metal 3x

R.sz.	leírás	TPI
24308	225 x 19 x 1 mm	TPI 10 - 14



1

**FESTA**

## ORRFŰRÉSZ LAPOK

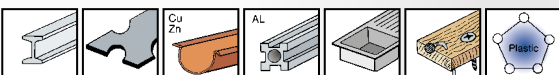
Bi  
Metal 3x

R.sz.	leírás	TPI
24310	150 x 22 x 1,6 mm	TPI 9



1

**FESTA**

## ORRFŰRÉSZ LAPOK

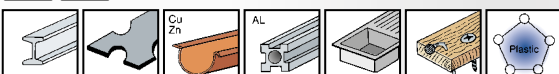
Bi  
Metal 3x

R.sz.	leírás	TPI
24313	225 x 22 x 1,6 mm	TPI 6



1

**FESTA**

## ORRFŰRÉSZ LAPOK

HSS

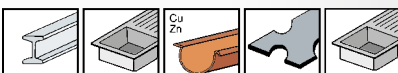

R.sz.	leírás	TPI
24050	203 x 19 x 1 mm	TPI 10 - 14



25

**FESTA**

## ORRFŰRÉSZ LAPOK

· Keményfém technológia

TC 3x

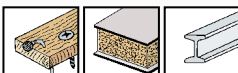

R.sz.	leírás	TPI
24312	225 x 19 x 1,3 mm	TPI 6 - 9



1

**FESTA**

## ORRFŰRÉSZ LAPOK

TC



R.sz.	leírás
24315	305 x 50 x 1,5 mm
24316	455 x 50 x 1,5 mm



1

25

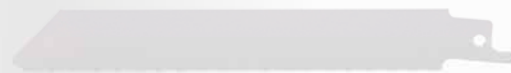
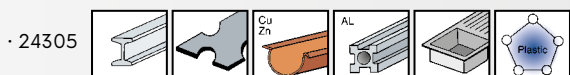
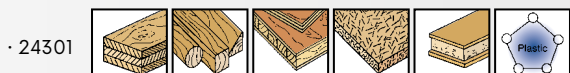

**FESTA**

ORRFŰRÉSZ LAP KLT.

Bi Metal HCS 3x

R.s. leírás  
24314



FŰRÉSZLAP ÁGVÁGÓBA

· edzett fogazás



R.s.	leírás	
24185	533 mm	1
24186	610 mm	1
24187	760 mm	1
24188	800 mm	1
24189	914 mm	1



**FESTA**

FŰRÉSZLAP ÁGVÁGÓBA

· edzett fogazás



R.s.	leírás	
24169	350 mm	10
24167	450 mm	10
24166	533 mm	10
24163	610 mm	10
24164	760 mm	10
24168	800 mm	10
24165	914 mm	10



FŰRÉSZLAP



R.s.	leírás	
24195	span 3 mm   300 mm	1
24196	span 4 mm   300 mm ferde fogazás	1
24197	span 5 mm   300 mm edzett fogazás	1
24192	penge a hentesfűrészhez 450 mm	1



CSERE FŰRÉSZLAP FOGAZÁS

R.s.	leírás	
24160	span 3 mm   300 mm	20
24161	span 4 mm   300 mm	20
24162	span 5 mm   300 mm	50



FŰRÉSZLAP

10x

R.s.	leírás	
24108	6 mm   150 mm	1



R.s.	leírás	
24120	300 mm	50

VÁGÓSZÁL GYÉMÁNTOS KERÁMIÁRA



**FESTA****BI-METAL FŰRÉSZLAP**

8 % COBALT



R.sz.	leírás
24180	300 mm



125
-----

**FESTA****FŰRÉSZLAP**

MOQ

R.sz.	leírás		
24109	12,5 mm   300 mm	Fémre	144
24118	25 mm   300 mm	Fémrel, kétoldalú	72
24119	25 mm   300 mm	fém és fa számára	72

**FESTA****FÉMFŰRÉSZ ERGONOMIKUS**

R.sz.	leírás
24104	300 mm



6
---

**FESTA****FÉMFŰRÉSZ**

nehéz szolgálat



R.sz.	leírás
24102	300 mm



6
---

**FÉMFŰRÉSZ**

R.sz.	leírás
24153	300 mm

12
----

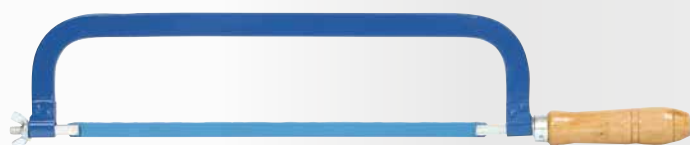
**FÉMFŰRÉSZ**

R.sz.	leírás
24100	300 mm

12
----





FÉMFŰRÉSZ



R.sz.	leírás	
24170	300 mm	12



FESTA  
FÉMFŰRÉSZ



2x



R.sz.	leírás	
24126	300 x 25 x 0,65 mm TPI 24   14	10



FÉMFŰRÉSZ

· fűrészlap 24108



R.sz.	leírás	
24125	150 mm	6



FÉMFŰRÉSZ

· fűrészlap 24109



R.sz.	leírás	
24124	260 mm	1210



FŰRÉSZ



R.sz.	leírás	
24121		12
24110	fűrészlap	30



FŰRÉSZ

· 5x fűrészlap



R.sz.	leírás	
24122		20
24111	fűrészlap	30

**FESTA****RÓKAFARK FŰRÉSZ**

TEFLON



3x élezett, edzett fogazás



R.sz.	leírás	
24143	300 mm	12
24144	400 mm	12
24145	500 mm	12

**FESTA****ILLESZTŐ FŰRÉSZ**

TEFLON



3x élezett, edzett fogazás

R.sz.	leírás	
24147	300 mm	6

**FESTA****LYUKFŰRÉSZ**

3x élezett, edzett fogazás

R.sz.	leírás	
24149	300 mm	12

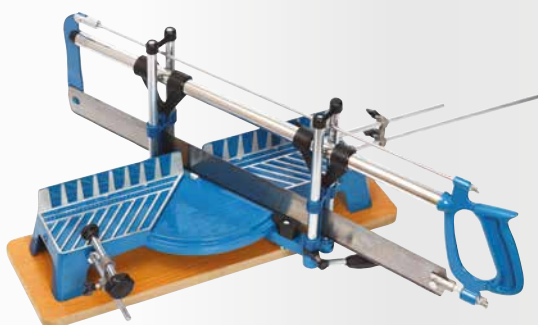
**GHÉRVÁGÓ FŰRÉSZ**

R.sz.	leírás	
24130	600 mm	1
24131	600 mm, fűrészlap	1

**GHÉRLÁDA MŰA.**

R.sz.	leírás	
24133	300 x 140 mm	18

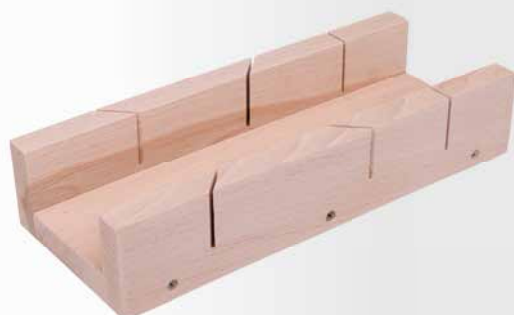
**GHÉRLÁDA FA**

R.sz.	leírás	
24171	80 x 300 mm	10

**GÉRVÁGÓ FŰRÉSZ + LÁDA**

R.sz.	leírás	
24148	300 mm	25





**FESTA**

**EGYKEZES ÁGVÁGÓFŰRÉSZ**

edzett fogazás

R.sz.	leírás		R.sz.	leírás	
24141	450 mm	12	24136	760 mm	12
24140	533 mm	12	24142	800 mm	12
24135	610 mm	12	24137	914 mm	12

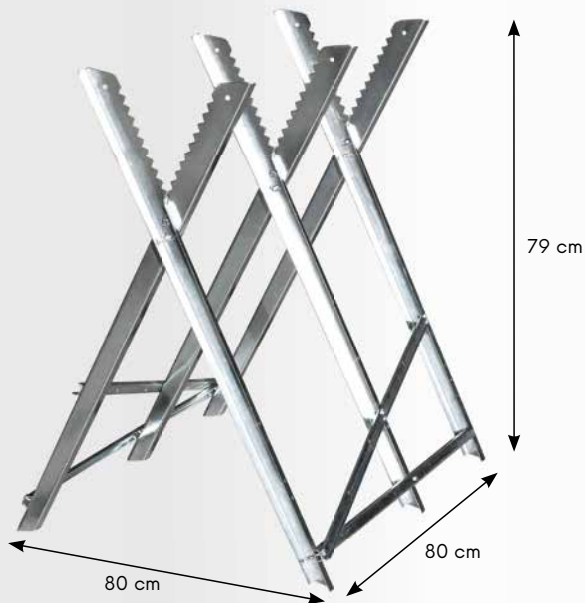

**FESTA**

**EGYKEZES ÁGFŰRÉSZ, FORG.**

edzett fogazás

R.sz.	leírás	
24173	350 mm	24

**FAVÁGÓ ÁLLVÁNY**



R.sz.	leírás	
37570	max. 150 kg	3



**KERETES FAFŰRÉSZ**



R.sz.	leírás	
24151	300 mm	10

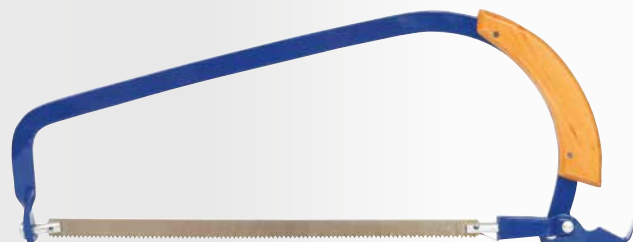

**GALLYAZÓ FŰRÉSZ**



R.sz.	leírás	
24150	300 mm	5

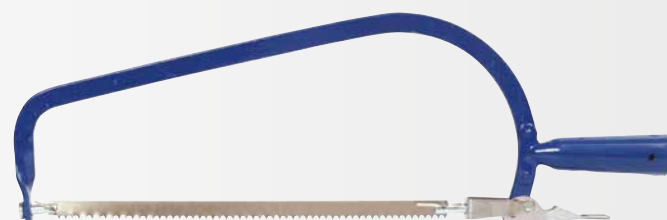

**GALLYAZÓ FŰRÉSZ**



R.sz.	leírás	
24154	300 mm	10



**FŰRÉSZ**

R.sz.	leírás	
24128	450 mm fűrészlap 24192	6

**FESTA****BECSUKHATÓ KERTIFŰRÉSZ**

3x élezett, edzett fogazás



R.sz.	leírás
45061	150 mm összecukható

12

**FESTA****BECSUKHATÓ KERTIFŰRÉSZ**

3x élezett, edzett fogazás



R.sz.	leírás
45060	180 mm

6

**FESTA****KERTIFŰRÉSZ TOKKAL**

3x élezett, edzett fogazás



R.sz.	leírás
45062	260 mm esettel

24

**FESTA****ÍVES ÁGVÁGÓ FŰRÉSZ**

3x élezett, edzett fogazás

R.sz.	leírás
24152	350 mm 7 tpi

12

**FESTA****TELESZKÓPOS ÁGVÁGÓ FŰRÉSZ**

3x élezett, edzett fogazás

R.sz.	leírás
45033	230 - 490 mm

1

**ÁGVÁGÓ FŰRÉSZ**

R.sz.	leírás
45030	fűrész 30 cm teleszkópos pólus 260 cm
45031	fűrész 30 cm

6

6

**ÁGVÁGÓ FŰRÉSZ**

R.sz.	leírás
45032	Fém, fűrész nélkül

6



**FESTA**  
POLYSTIROL FŰRÉSZ

R.sz.	leírás	
24174	370 mm	1



**FESTA**  
GIPSZKARTON FŰRÉSZ



3x élézett, edzett fogazás



R.sz.	leírás	
24159	150 mm	12



GIPSZKARTON LYUKFÚRÓ



R.sz.	leírás	
24190	270 mm	10



**FESTA**  
YTONG FŰRÉSZ



R.sz.	leírás	
24181	550 mm	1



**FESTA**  
YTONG FŰRÉSZ



R.sz.	leírás	
24158	22   22 SK fogú - 450 mm	5



**FESTA**  
YTONG FŰRÉSZ



R.sz.	leírás	
24155	34   17 SK fogú - 630 mm	2
24156	34   34 SK fogú - 630 mm	2



**FESTA**  
YTONG FŰRÉSZ

R.sz.	leírás	
24176	34   17 SK fogú - 750 mm	6
24177	34   34 SK fogú - 750 mm	6



**FESTA**  
YTONG FŰRÉSZ

edzett fogazás







R.sz.	leírás	
24175	bez SK fogú - 600 mm EU	2
24178	bez SK fogú - 600 mm	6

# FESTA®



Lemezhasználati táblázat

				
materiál	festo industry	full	turbo	segment
tégla	••	••	••	••
bevonat	••	•••	••	-
kő	••	••	••	••
konkrét	•••	•	•••	•••
vasbeton	-	-	•••	-
tetőcserép	••	•	••	••
üveg	-	•••	-	-
márvány	•	••	•	•
granit	•••	••	•••	••
homokkő	••	-	••	••
aszfalt	-	••	-	••
kvarc	••	•	••	•



## FESTA INDUSTRY

### GYÉMÁNT VÁGÓTÁRCSA

R.sz.	leírás			
21200	Ø 115 mm 1,4 mm	Ø 22,2 mm		1
21201	Ø 125 mm 1,4 mm	Ø 22,2 mm		1
21204	Ø 200 mm 1,8 mm	Ø 25,4 mm		1
21203	Ø 230 mm 1,8 mm	Ø 22,2 mm		1

## FESTA®

### GYÉMÁNT VÁGÓTÁRCSA FOLYTONOS

R.sz.	leírás			
21210	Ø 110 mm Ø 22,2 mm			1
21211	Ø 115 mm Ø 22,2 mm			1
21212	Ø 125 mm Ø 22,2 mm			1
21215	Ø 150 mm Ø 22,2 mm			1
21218	Ø 180 mm Ø 22,2 mm			1
21219	Ø 180 mm Ø 25,4 mm			1
21220	Ø 200 mm Ø 25,4 mm			1
21223	Ø 230 mm Ø 22,2 mm			1
21224	Ø 300 mm Ø 25,4 mm			1



**FESTA**

## GYÉMÁNT VÁGÓTÁRCSA SZEGMENTÁLT

R.sz.	leírás		
21311	Ø 115 mm	Ø 22,2 mm	1
21312	Ø 125 mm	Ø 22,2 mm	1
21315	Ø 150 mm	Ø 22,2 mm	1
21318	Ø 180 mm	Ø 22,2 mm	1
21323	Ø 230 mm	Ø 22,2 mm	1
21324	Ø 300 mm	Ø 25,4 mm	1
21327	Ø 350 mm	Ø 25,4 mm	1
21326	Ø 400 mm	Ø 25,4 mm	1



**FESTA**

## TURBO GYÉMÁNT VÁGÓTÁRCSA

R.sz.	leírás		
21410	Ø 110 mm	Ø 22,2 mm	1
21411	Ø 115 mm	Ø 22,2 mm	1
21412	Ø 125 mm	Ø 22,2 mm	1
21415	Ø 150 mm	Ø 22,2 mm	1
21418	Ø 180 mm	Ø 22,2 mm	1
21423	Ø 230 mm	Ø 22,2 mm	1
21424	Ø 300 mm	Ø 25,4 mm	1



**FESTA**

## GYÉMÁNT VÁGÓTÁRCSA SZEGMENTÁLT



R.sz.	leírás		
21301	Ø 125 mm	Ø 22,2 mm	1,5 mm
21303	Ø 230 mm	Ø 22,2 mm	1,8 mm

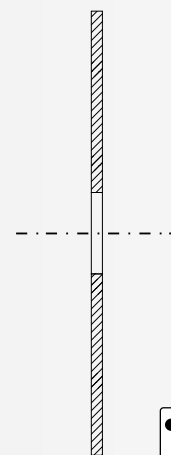

## GYÉMÁNT VÁGÓTÁRCSA FOLYTONOS

R.sz.	leírás		
21010	Ø 110 mm Ø 22,2 mm		1
21011	Ø 115 mm Ø 22,2 mm		1
21012	Ø 125 mm Ø 22,2 mm		1
21015	Ø 150 mm Ø 22,2 mm		1
21018	Ø 180 mm Ø 22,2 mm		1
21023	Ø 230 mm Ø 22,2 mm		1

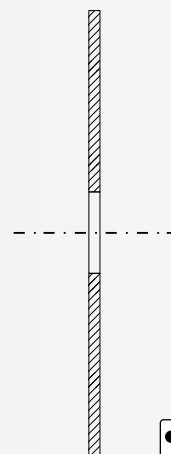

## GYÉMÁNT VÁGÓTÁRCSA SZEGMENTÁLT

R.sz.	leírás		
21110	Ø 110 mm Ø 22,2 mm		1
21111	Ø 115 mm Ø 22,2 mm		1
21112	Ø 125 mm Ø 22,2 mm		1
21115	Ø 150 mm Ø 22,2 mm		1
21118	Ø 180 mm Ø 22,2 mm		1
21123	Ø 230 mm Ø 22,2 mm		1

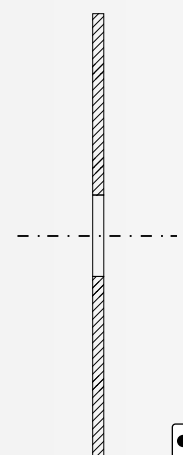

## GYÉMÁNT VÁGÓTÁRCSA TURBO

R.sz.	leírás		
21130	Ø 110 mm Ø 22,2 mm		1
21135	Ø 115 mm Ø 22,2 mm		1
21140	Ø 125 mm Ø 22,2 mm		1
21150	Ø 150 mm Ø 22,2 mm		1
21180	Ø 180 mm Ø 22,2 mm		1
21190	Ø 230 mm Ø 22,2 mm		1



**FESTA**

**GYÉMÁNT CSISZOLÓTÁRCSA**



R.sz.	leírás		
21430	Ø 115 mm    Ø 22,2 mm		1
21431	Ø 125 mm    Ø 22,2 mm		1
21432	Ø 150 mm    Ø 22,2 mm		1



**FESTA**

**GYÉMÁNT CSISZOLÓTÁRCSA**



R.sz.	leírás		
21425	Ø 100 mm    Ø 22,2 mm		1
21426	Ø 115 mm    Ø 22,2 mm		1
21427	Ø 125 mm    Ø 22,2 mm		1
21428	Ø 150 mm    Ø 22,2 mm		1



6 mm



**FESTA**

**TURBO GYÉMÁNT VÁGÓTÁRCSA**



R.sz.	leírás		
21195	Ø 125 x 22,2 mm		1

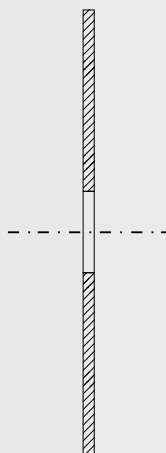

NEW



FESTA

## FÉM VÁGÓ KORONG



R.sz.	leírás			
22211	Ø 115 mm	Ø 22,2 mm x 1 mm	INOX	50
22212	Ø 115 mm	Ø 22,2 mm x 1,2 mm	INOX	50
22225	Ø 125 mm	Ø 22,2 mm x 1 mm	INOX	50
22217	Ø 125 mm	Ø 22,2 mm x 1,2 mm	INOX	50

R.sz.	leírás			
22251	Ø 115 mm	Ø 22,2 mm x 1,6 mm		50
22215	Ø 115 mm	Ø 22,2 mm x 2 mm		50
22216	Ø 115 mm	Ø 22,2 mm x 2,5 mm		50
22252	Ø 125 mm	Ø 22,2 mm x 1,6 mm		25
22218	Ø 125 mm	Ø 22,2 mm x 2,5 mm		25
22219	Ø 150 mm	Ø 22,2 mm x 1,2 mm		25
22253	Ø 150 mm	Ø 22,2 mm x 1,6 mm		50
22220	Ø 150 mm	Ø 22,2 mm x 2,5 mm		50
22254	Ø 180 mm	Ø 22,2 mm x 1,6 mm		50
22222	Ø 180 mm	Ø 22,2 mm x 2,5 mm		25
22255	Ø 230 mm	Ø 22,2 mm x 1,6 mm		25
22224	Ø 230 mm	Ø 22,2 mm x 2,5 mm		25

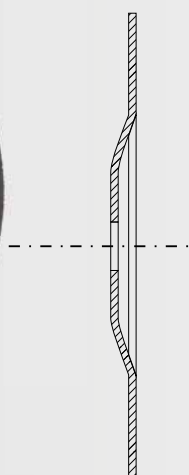

FESTA

## FÉM TISZTÍTÓ KORONG



R.sz.	leírás			
22240	Ø 115 mm	Ø 22,2 mm x 6,4 mm		25
22242	Ø 125 mm	Ø 22,2 mm x 6,4 mm		25
22244	Ø 150 mm	Ø 22,2 mm x 6,4 mm		25
22246	Ø 180 mm	Ø 22,2 mm x 6,4 mm		25
22248	Ø 230 mm	Ø 22,2 mm x 6,4 mm		25

FESTA

## FÉM VÁGÓ KORONG

10x

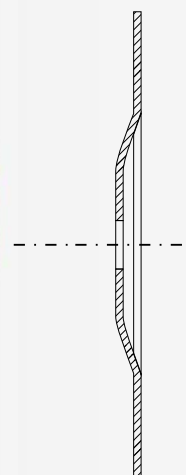

R.sz.	leírás			
22228	Ø 115 mm	Ø 22,2 mm x 1 mm		1
22229	Ø 125 mm	Ø 22,2 mm x 1,2 mm		1

FESTA  
INDUSTRY

## FÉM VÁGÓ KORONG

MADE IN EU  
OS

R.sz.	leírás			
22258	NEW Ø 115 mm	Ø 22,2 mm x 0,8 mm		25
22260	Ø 115 mm	Ø 22,2 mm x 1 mm		25
22263	Ø 115 mm	Ø 22,2 mm x 1,6 mm		25
22264	NEW Ø 115 mm	Ø 22,2 mm x 2 mm		25
22259	Ø 125 mm	Ø 22,2 mm x 0,8 mm		25
22266	Ø 125 mm	Ø 22,2 mm x 1 mm		25
22269	Ø 125 mm	Ø 22,2 mm x 1,6 mm		25
22270	Ø 125 mm	Ø 22,2 mm x 2 mm		25
22273	Ø 150 mm	Ø 22,2 mm x 1,6 mm		25
22274	Ø 150 mm	Ø 22,2 mm x 2 mm		25
22275	Ø 150 mm	Ø 22,2 mm x 2,5 mm		25
22277	Ø 180 mm	Ø 22,2 mm x 2 mm		25
22280	Ø 230 mm	Ø 22,2 mm x 2 mm		25
22281	Ø 230 mm	Ø 22,2 mm x 2,5 mm		25



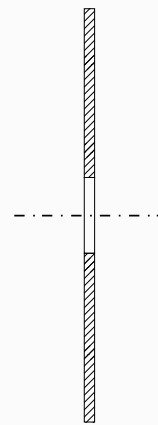
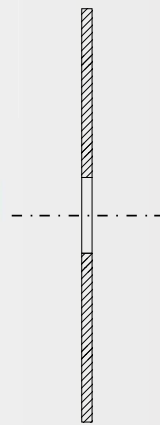

**FESTA**  
INDUSTRY

## VÁGÓKORONG ALUMÍNIUM ANYAGOKRA



R.sz.	leírás		
22285	Ø 115 mm Ø 22,2 mm x 1 mm	1	
22286	Ø 125 mm Ø 22,2 mm x 1 mm	1	

**FESTA**

## GYÉMÁNT VÁGÓTÁRCSA SZEGMENTÁLT



R.sz.	leírás		
21306	Ø 125 mm Ø 22,2 mm 1,3 mm	1	
21308	Ø 230 mm Ø 22,2 mm 1,8 mm	1	

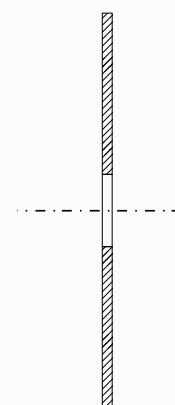

**FESTA**

## VÁGÓTÁRCSA SZEGMENTÁLT - KARBID



R.sz.	leírás		
21192	Ø 125 mm Ø 22,2 mm	1	
21194	Ø 230 mm Ø 22,2 mm	1	

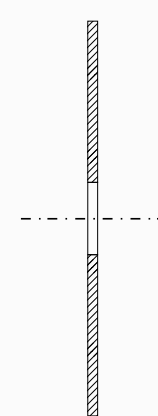
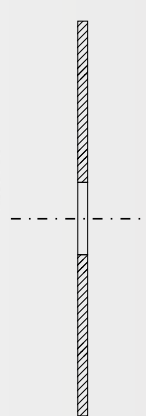

**FESTA**  
INDUSTRY

## KŐVÁGÓ KORONG



R.sz.	leírás		
22294	Ø 230 mm Ø 22,2 mm x 3 mm	1	

**FESTA**

## KŐVÁGÓ KORONG



R.sz.	leírás		
22230	Ø 115 mm Ø 22,2 mm x 2,5 mm	50	
22232	Ø 125 mm Ø 22,2 mm x 2,5 mm	50	
22234	Ø 150 mm Ø 22,2 mm x 2,5 mm	25	
22236	Ø 180 mm Ø 22,2 mm x 2,5 mm	25	
22238	Ø 230 mm Ø 22,2 mm x 2,5 mm	25	

NEW



## FAVÁGÓ KORONG



R.s.	Leírás
21804	Ø 125 mm    Ø 22,2 mm    14T

1

NEW



FESTA

## CSIZOLÓ ÉS VÁGÓ KORONG



R.s.	Leírás
21803	Ø 125 mm    Ø 22,2 mm

1

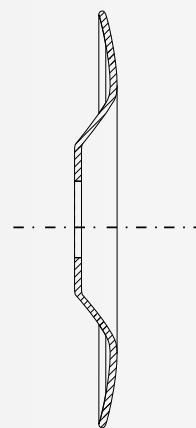

FESTA

## FAFORGÁCSOLÓ KORONG - KÖZEPESEN DURVA



R.s.	leírás
21802	Ø 125 mm    Ø 22,2 mm    3 mm

10



FESTA

## FAFORGÁCSOLÓ KORONG - DURVA



R.s.	leírás
21801	Ø 125 mm    Ø 22,2 mm    3 mm

10

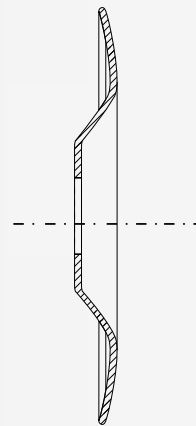

FESTA

## FA CSIZOLÓ KORONG

Csiszolókorong fa csiszolásához



R.s.	leírás
21800	Ø 125 mm    Ø 22,2 mm

1

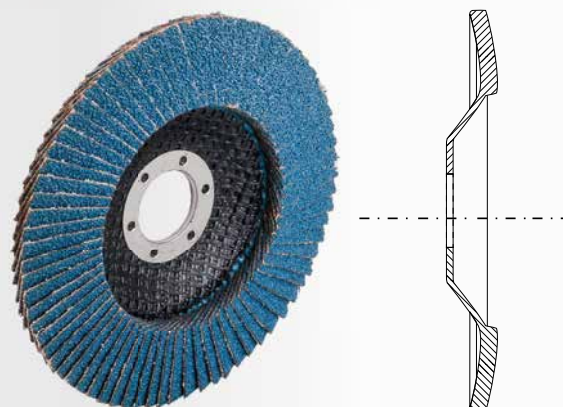
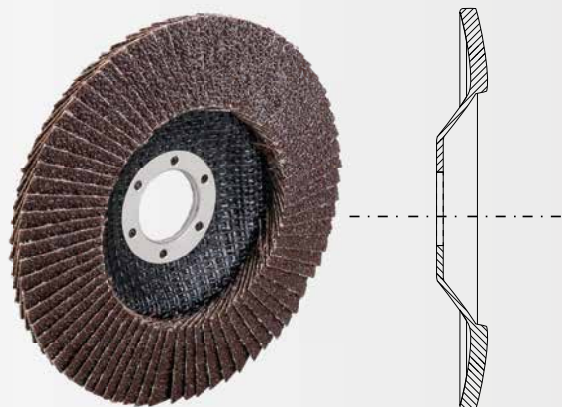

## LAMELLÁS CSISZOLÓ



R.sz.	leírás	érdesség	
21780	Ø 115 mm Ø 22,2 mm	P40	10
21781	Ø 115 mm Ø 22,2 mm	P60	10
21782	Ø 115 mm Ø 22,2 m	P80	10
21783	Ø 115 mm Ø 22,2 mm	P100	10
21784	Ø 115 mm Ø 22,2 mm	P120	10
21786	Ø 125 mm Ø 22,2 mm	P40	10
21787	Ø 125 mm Ø 22,2 mm	P60	10
21788	Ø 125 mm Ø 22,2 mm	P80	10
21789	Ø 125 mm Ø 22,2 mm	P100	10
21790	Ø 125 mm Ø 22,2 mm	P120	10
21792	Ø 150 mm Ø 22,2 mm	P40	10
21793	Ø 150 mm Ø 22,2 mm	P60	10
21794	Ø 150 mm Ø 22,2 mm	P80	10
21795	Ø 150 mm Ø 22,2 mm	P100	10
21796	Ø 150 mm Ø 22,2 mm	P120	10

## FESTA

## LAMELLÁS CSISZOLÓ

grinding disc suitable mert gringing stainless steel



R.sz.	leírás	érdesség	
22140	Ø 115 mm Ø 22,2 mm	P40	5
22141	Ø 115 mm Ø 22,2 mm	P60	5
22142	Ø 115 mm Ø 22,2 mm	P80	5
22143	Ø 115 mm Ø 22,2 mm	P100	5
22145	Ø 125 mm Ø 22,2 mm	P40	5
22146	Ø 125 mm Ø 22,2 mm	P60	5
22147	Ø 125 mm Ø 22,2 mm	P80	5
22148	Ø 125 mm Ø 22,2 mm	P100	5
22150	Ø 150 mm Ø 22,2 mm	P40	5
22151	Ø 150 mm Ø 22,2 mm	P60	5
22155	Ø 150 mm Ø 22,2 mm	P80	5
22156	Ø 150 mm Ø 22,2 mm	P100	5



## KÖRKEFE NYLON



R.sz.	leírás	
21798	Ø 125 mm Ø 22,2 mm	1





293

POLISTIROL VÁGÓ



298

KŐPORSZORÓ



300

ÉGŐ, TÖMLŐ NÉLKÜL



304

KŐMŰVES VÖDÖR

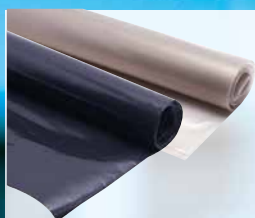

305

SZEMETESZSÁK



306

SZALAG



310

KINYOMÓPISZTOLY



313

PURHABKINYOMÓ  
PISZTOLY

314

FORRÓ LEVEGŐS PISZTOLYOK  
HŐMÉRSÉKLET

## ÉPÍTKEZÉSI SZERSZÁMOK 242 - 329



316

FESTŐKÉSZLET



322

LETAKARÓ PONYVA



324

RÖGZÍTŐ HOROGOK,  
LÁNCOK

327

LÁMPA ÉPÍTÉSI HELYSZÍNRE



328

LÉTRA



328

ÁLLÍTHATÓ KELLÉKEK

KŐMŰVES  
SZERSZÁMOK**FESTA**

GLETTVAS ROZSDAMENTES 280 X 130 MM

· gumi fogantyú



R.sz.	leírás	
31140	egyenes	10

**FESTA**

GLETTVAS ROZSDAMENTES 280 X 130 MM

· gumi fogantyú



R.sz.	leírás	
31148	egyenes	10

**FESTA**

GLETTVAS ROZSDAMENTES 280 X 130 MM

· gumi fogantyú



R.sz.	leírás	
31146	○ 16	10

**FESTA**

GLETTVAS ROZSDAMENTES 280 X 130 MM

· gumi fogantyú



R.sz.	leírás		R.sz.	leírás	
31141	e 4	10	31144	e 10	10
31142	e 6	10	31145	e 12	10
31143	e 8	10			

**FESTA**

GLETTVAS ROZSDAMENTES 280 X 130 MM



R.sz.	leírás		R.sz.	leírás	
31101	e 4	10	31131	e 10	10
31111	e 6	10	31132	e 12	10
31121	e 8	10			

**FESTA**

GLETTVAS ROZSDAMENTES 280 X 130 MM



R.sz.	leírás	
31091	egyenes	10



**FESTA**

GLETTVAS ROZSDAMENTES 280 X 130 MM



R.s.	leírás	
31011	egyenes	10



**FESTA**

GLETTVAS ROZSDAMENTES 280 X 130 MM



R.s.	leírás		R.s.	leírás	
31021	e 4	10	31051	e 10	10
31031	e 6	10	31053	e 12	10
31041	e 8	10			



GLETTVAS ROZSDAMENTES 270 X 125 MM



R.s.	leírás	
31005	egyenes	25



GLETTVAS ROZSDAMENTES 270 X 125 MM



R.s.	leírás		R.s.	leírás	
31006	e 4	24	31008	e 8	24
31007	e 6	24	31009	e 10	24



**FESTA**

GLETTVAS ROZSDAMENTES 360 X 130 MM



R.s.	leírás	
31151	egyenes	10

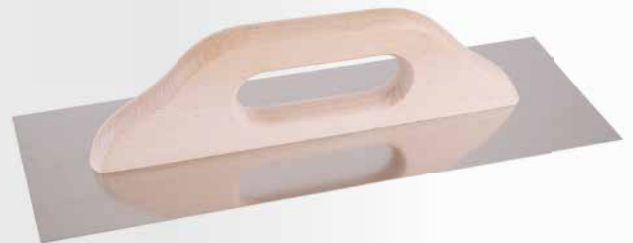

**FESTA**

GLETTVAS ROZSDAMENTES 360 X 130 MM



R.s.	leírás	
31150	egyenes	10



**FESTA**

GLETTVAS ROZSDAMENTES 480 X 130 MM



R.s.	leírás	
31082	egyenes	10



**FESTA**

GLETTVAS ROZSDAMENTES 680 X 130 MM



R.s.	leírás	
31155	egyenes	10

**FESTA**

GLETTVAS ROZSDAMENTES 500 X 130 MM

INOX

R.sz.	leírás	
31081	egyenes	10

**FESTA**

GLETTVAS ROZSDAMENTES

INOX

R.sz.	leírás	
31052	e 4	10
31061	e 6	10
31062	e 8	10
31071	e 10	10
31072	e 12	10

**FESTA**

ROZSDAMENTES KANÁL

gumi fogantyú

INOX

R.sz.	leírás		R.sz.	leírás	
31232	120 mm	10	31234	160 mm	10
31233	140 mm	10	31235	180 mm	10

**FESTA**

ROZSDAMENTES KANÁL

INOX

R.sz.	leírás		R.sz.	leírás	
31220	120 x 80 mm	10	31222	160 x 115 mm	10
31221	140 x 80 mm	10	31231	180 x 120 mm	10

**FESTA**

ROZSDAMENTES KANÁL

gumi fogantyú

INOX

R.sz.	leírás	
31334	160 x 100 mm	10

**FESTA**

ROZSDAMENTES KANÁL

INOX

R.sz.	leírás	
31343	160 x 100 mm	10

**FESTA**

ROZSDAMENTES GIPSZELŐ KANÁL

gumi fogantyú

INOX

R.sz.	leírás		R.sz.	leírás	
31360	40 mm	10	31400	100 mm	10
31380	60 mm	10	31403	120 mm	10
31390	80 mm	10			

**FESTA**

ROZSDAMENTES GIPSZELŐ KANÁL

INOX

R.sz.	leírás		R.sz.	leírás	
31362	40 mm	10	31392	80 mm	10
31382	60 mm	10	31402	100 mm	10
			31404	120 mm	10





**FESTA**

ROZSDAMENTES MACSKANYELV KANÁL

· gumi fogantyú

**INOX**

R.s.	leírás	
31330	140 x 50 mm	10
31340	160 x 60 mm	10



**FESTA**

ROZSDAMENTES MACSKANYELV KANÁL

**INOX**

R.s.	leírás	
31332	140 x 50 mm	10
31341	160 x 60 mm	10



**FESTA**

BELSŐSAROK KANÁL ROZSDAMENTES

· gumi fogantyú

**INOX**

R.s.	leírás	
31280	80 x 60 x 60 mm	10



**FESTA**

BELSŐSAROK KANÁL ROZSDAMENTES

**INOX**

R.s.	leírás	
31281	80 x 60 x 60 mm	10



**FESTA**

KÜLSŐSAROK KANÁL ROZSDAMENTES

· gumi fogantyú

**INOX**

R.s.	leírás	
31270	80 x 60 x 60 mm	10



**FESTA**

KÜLSŐSAROK KANÁL ROZSDAMENTES

**INOX**

R.s.	leírás	
31271	80 x 60 x 60 mm	10



**FESTA**

ROZSDAMENTES BÁDOGOS KANÁL

· gumi fogantyú

**INOX**

R.s.	leírás	
31320	140 x 75 mm	10



**FESTA**

ROZSDAMENTES BÁDOGOS KANÁL

**INOX**

R.s.	leírás	
31322	140 x 75 mm	10

**FESTA**

## ROZSDAMENTES KANÁL

**INOX**

R.s.	leírás	
31218	180 mm e ó	12

**FESTA**

## ROZSDAMENTES SPAKLI

· gumi fogantyú

**INOX**

R.s.	leírás		R.s.	leírás	
31510	40 mm	10	31513	100 mm	10
31511	60 mm	10	31514	120 mm	10
31512	80 mm	10	31515	140 mm	10

**FESTA**

## ROZSDAMENTES SPAKLI - KAPARÓ

**INOX**

R.s.	leírás		R.s.	leírás	
31461	40 mm	12	31491	100 mm	12
31471	60 mm	12	31467	120 mm	12
31481	80 mm	12	31468	140 mm	12

**FESTA**

## KAPARÓ SPAKLI, GUMI NYÉLLEL

· gumi fogantyú  
· vastagított penge**INOX**

R.s.	leírás	
32173	75 mm	10

**FESTA**

## PADLÓSZÖNYEG KAPARÓ, NYELEZHETŐ

· nyél 52010  
· vastagított penge**INOX**

R.s.	leírás	
32170	100 mm	12

**FESTA**

## GIPSZKARTON SPAKLI

· gumi fogantyú

**INOX**

R.s.	leírás	
31455	150 mm	12
31456	200 mm	12

**FESTA**

## KAPARÓ RIGIPS

· gumi fogantyú

**INOX**

R.s.	leírás	
31505	200 mm	5
31506	250 mm	5
31507	300 mm	5



**FESTA**

GLETTKÉS

INOX

R.sz.	leírás	
31555	35 cm	1
31556	45 cm	1
31557	60 cm	1

R.sz.	leírás	
31558	80 cm	1
31559	100 cm	1

NEW



**FESTA**

GLETTKÉS TARTÓ

· 31555 - 31559 esetén  
fogantyú 52010, 52011, 52012, 52020, 52030

R.sz.	Leírás	
31610		1

NEW

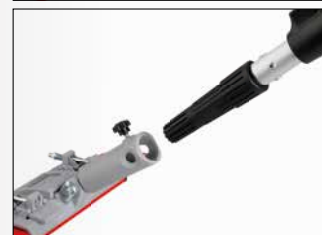

**FESTA**

TELESZKÓPOS FOGANTYÚ

· menet a 31610-hez, 34203-hoz

R.sz.	Leírás	
52011	88 - 140 cm	1



### ROZSDAMENTES ACÉL SPATULA ERŐSÍTÉSSEL

INOX

MADE IN EU



R.sz.	leírás	
31520	400 mm	1
31521	500 mm	
31522	600 mm	



### ROZSDAMENTES ACÉL SPATULA KIEGÉSZÍTŐK

MADE IN EU



R.sz.	leírás	
31523	ALU tartó	1
31524	műanyag tartó	1



FESTA

### HOMLOKZATI ROZSDAMENTES SPAKLI

INOX

R.sz.	leírás	
31552	400 mm	10
31553	600 mm	10



### HOMLOKZATI ROZSDAMENTES SPAKLI

INOX

MADE IN EU

R.sz.	leírás	
31541	250 mm	1
31551	250 mm keskeny	1



FESTA

### ROZSDAMENTES SPAKLI

INOX

R.sz.	leírás	
31498	150 mm	12
31499	200 mm	12
31500	100 mm	12



### ROZSDAMENTES FESTÉKKAPARÓ

INOX

MADE IN EU

R.sz.	leírás	
31493	40 mm	20
31494	60 mm	20
31495	80 mm	20
31496	100 mm	20



**FESTA**

**SPAKLI ACÉL**

R.sz.	leírás	
32161	30 mm	10
32162	40 mm	10
32163	50 mm	10
32164	60 mm	10
32169	70 mm	10
32165	80 mm	10



**FESTA**

**SPAKLI**

vastagított penge

**INOX**

R.sz.	szélesség	hossz	
32174	100 mm	500 mm	1



**SPAKLI ACÉL**

R.sz.	leírás	
32176	30 mm	12
32186	40 mm	12
32196	50 mm	12
32206	60 mm	12

R.sz.	leírás	
32216	80 mm	12
32226	100 mm	12
32234	125 mm	12



**ACÉL SPAKLI - KAPARÓ KÉSZLET**

**3x**

R.sz.	leírás	
32240	30, 50, 80 mm	10





## ACÉLSIMÍTÓ

R.sz.	leírás	
32062	280 x 160 mm	10
32076	400 x 100 mm	36
32060	500 x 140 mm	5



## ACÉLSIMÍTÓ ,HEGYES

R.sz.	leírás	
32064	500 x 90 mm	5
32066	550 x 140 mm	5



## KŐMŰVES KANÁL ACÉL

R.sz.	leírás	
32015	160 x 130 mm	10
32014	180 x 130 mm	10
32016	200 x 140 mm	10



## KŐMŰVES KANÁL ACÉL

R.sz.	leírás	
32001	160 x 110 mm	10
32002	160 x 130 mm	10
32003	180 x 130 mm	10
32013	200 x 140 mm	10



## KŐMŰVES KANÁL ACÉL GÖMBÖLYŰROTUNJIT

R.sz.	leírás	
32018	160 x 110 mm	10



## GIPSZELŐKANÁL ACÉL

R.sz.	leírás	
32024	140 x 80 mm	12



## KŐMŰVES MACSKANYELV KANÁL ACÉL

R.sz.	leírás	
32020	140 x 65 mm	12
32021	140 x 40 mm	12



## BÁDOGOSKANÁL ACÉL

R.sz.	leírás	
32026	140 x 85 mm	12



**FESTA**

KŐMŰVES SERPENYŐ, HORGANYZOTT

**INOX**

R.sz.	leírás	
32285	Ø 180 mm	1



**FESTA**

KŐMŰVES SERPENYŐ, POZINK MARKOLAT

**Zn**

R.sz.	leírás	
32265	Ø 180 mm	10



**FESTA**

KŐMŰVES SERPENYŐ

R.sz.	leírás	
32273	Ø 160 mm	10
32283	Ø 180 mm	10
32293	Ø 215 mm	10



KŐMŰVES SERPENYŐ MŰANYAG



R.sz.	leírás	
32270	Ø 160 mm	1



**HABARCSMERŐ**

fogantyú 61215

R.sz.	leírás	
32302	Ø 180 mm	1
32313	Ø 215 mm	1
32301	Ø 235 mm	1



**HABARCSMERŐ, HORGANYZOTT**

fogantyú 61200, 61201

R.sz.	leírás	
32268	Ø 215 mm	1
32269	Ø 235 mm	1
32296	Ø 215 mm	1



**HABARCSMERŐ, HORGANYZOTT**

**MOQ 3**

R.sz.	leírás	
32295	Ø 180 mm fogantyú 160 cm	3
32297	Ø 215 mm fogantyú 160 cm	3
32298	Ø 235 mm fogantyú 160 cm	3



**HABARCSKEVERŐ, NYÉL NÉLKÜL**

R.sz.	leírás	
60100	fogantyú nélkül 295 x 150 mm	24
61169	fogantyúval 160 cm	3
61218	fogantyú 160 cm	5

**FESTA**

## TÖBBFUNKCIÓS ROZSDAMENTES SPAKLI

INOX

R.sz.	leírás	
31497	63 x 195 mm	12

**FESTA**

## KITTKÉS

INOX

R.sz.	leírás	
31503	150 mm	12



## FESTÉKKAPARÓ

MADE IN EU

R.sz.	leírás	
31501	100 mm	30
31502	pótpenge	1



## GIPSZKARTONÓZÓ SPATULA

PLASTIC

R.sz.	leírás	
34308	50 mm	20
34307	80 mm	12
34306	100 mm	10
34305	150 mm	12

**FESTA**

## JAPÁN SPAKLI KLT.

4x

R.sz.	leírás	
31452	rozsdamentes 50, 80, 100, 120 mm	10
31453	acél 50, 80, 100, 120 mm	10

**FESTA**

## JAPÁN SPAKLI KLT., MŰA.

PLASTIC 4x

R.sz.	leírás	
31454	50, 80, 100, 120 mm	12





ACÉL SPATULA

R.s.	leírás	
31601	180 mm - egyenlő	1
31602	180mm A1	1
31603	180mm A2	1
31641	180 mm - e4	1



SPATULA FOGAZOTT ACÉL

R.s.	leírás	
31651	250 mm - sima	1
31655	250 mm - e4	1



MŰANYAG SPATULA

R.s.	leírás	
37101	150 x 80 mm	100
37111	170 x 115 mm	100



MŰANYAG SPATULA

R.s.	leírás	
37051	egyenlő	1
37031	fogak - 4 x 6 mm	1
37041	fogak - 6 x 6 mm	1



FUGÁZÓKANÁL ACÉL

R.s.	leírás	
32022	140 x 80 mm	12
32023	125 x 40 mm	12

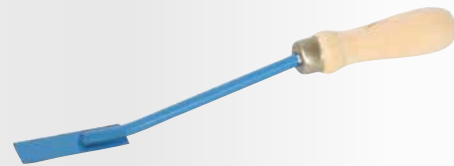

FUGÁZÓ KANÁL

R.s.	leírás	
32040	10 mm	20
32041	12 mm	20
32042	15 mm	20
32043	18 mm	20
32044	20 mm	20



FUGÁZÓ

R.s.	leírás	
32050	10   12 mm	50
32051	10   15 mm	50
32052	10   18 mm	50
32053	15   20 mm	50



HORONYMARÓ YTONGHOZ

R.s.	leírás	
32037	600 mm	1

**FESTA****YTONG KAPARÓ**

· nyárfa



R.sz.	leírás
32317	450 x 95 mm

2

**FESTA****YTONG KAPARÓ - FINOM FOG**

· nyárfa



R.sz.	leírás
32312	450 x 95 mm

2

**FESTA****YTONG KAPARÓ**

· nyárfa



R.sz.	leírás
32337	260 x 95 mm

2

**FESTA****YTONG KAPARÓ - FINOM FOG**

· nyárfa



R.sz.	leírás
32338	260 x 95 mm

2

**FESTA****VAKOLATGYALU FA**

· nyárfa



R.sz.	leírás
32327	230 x 145 mm

2

**NEW****YTONG KAPARÓ**

R.sz.	leírás
32332	450 x 95 mm

2

**NEW****VAKOLATGYALU FA**

R.sz.	leírás
32333	230 x 145 mm

2



**FESTA**

KAPARÓ RÉGI VAKOLATRA



R.sz.	leírás
32314	400 x 180 mm



**FESTA**

KAPARÓ RÉGI VAKOLATRA



R.sz.	leírás
32329	270 x 130 mm



**FESTA**

KAPARÓ RÉGI VAKOLATRA



R.sz.	leírás
33168	380 x 160 mm

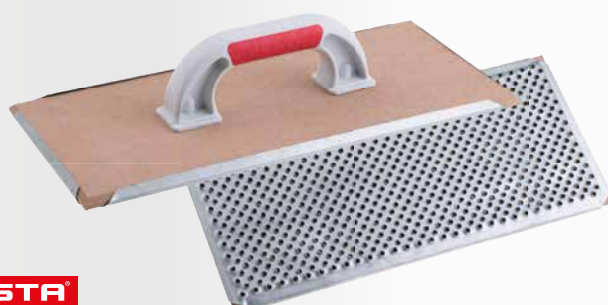

**FESTA**

KAPARÓ RÉGI VAKOLATRA



R.sz.	leírás
32320	400 x 180 mm



**NEW**



KAPARÓ RÉGI VAKOLATRA



R.sz.	leírás
32311	400 x 180 mm



**FESTA**

STYROPOR CSISZOLÓ



R.sz.	leírás
32418	400 x 180 mm P 16
32421	400 x 180 mm P 16 Csiszoló pótlap



**FESTA**

STYROPOR CSISZOLÓ



R.sz.	leírás
32318	400 x 180 mm
32319	500 x 250 mm
32321	400 x 180 mm P 16 Csiszoló pótlap
32322	500 x 250 mm P 16 Csiszoló pótlap

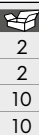

**FESTA**

STYROPOR CSISZOLÓ MŰA.



R.sz.	leírás
32324	270 x 130 mm P 16
32323	270 x 130 mm P 16 Csiszoló pótlap



**FESTA**

STYROPOR CSISZOLÓ MŰA.

MADE IN  
**EU**MOQ  
**2**

R.sz.	leírás	MOQ
32330	400 x 180 mm	2
32331	270 x 130 mm	2

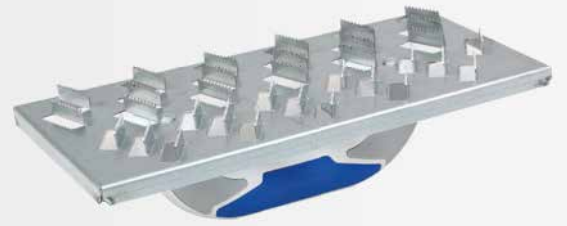

KAPARÓ KŐGYAPOTHOZ

Zn  
MADE IN  
**EU**MOQ  
**2**

R.sz.	leírás	MOQ
32328	285 x 145 mm	10

**FESTA**

KAPARÓ

MADE IN  
**EU**MOQ  
**2**

R.sz.	leírás	MOQ
32325	225 x 105 mm	2

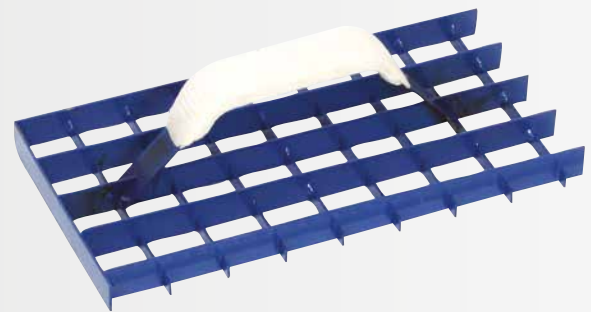

VAKOLATGYALU RÁCSOS

MOQ  
**2**

R.sz.	leírás	MOQ
32316	280 x 150 mm	20

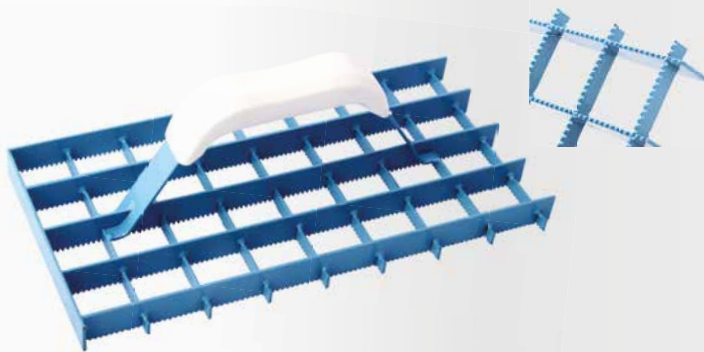

VAKOLATGYALU RÁCSOS FOGAZOTT

MOQ  
**2**

R.sz.	leírás	MOQ
32335	290 x 145 mm	2



VAKOLATGYALU

· 8 pengével

ALU

MOQ  
**2**

R.sz.	leírás	MOQ
32326	450 x 90 mm	20



VAKOLATGYALU MŰANYAG

· 6 pengével

MOQ  
**2**

R.sz.	leírás	MOQ
32315	270 x 90 mm	30

**NEW**

MŰANYAG SIMÍTÓ ERŐSÍTETT

MADE IN  
**EU**

R.sz.	leírás	MOQ
34028	400 x 180 mm	20



**FESTA**

MŰANYAG SIMÍTÓ ERŐSÍTETT



R.sz.	leírás	
34027	400 x 180 mm	20



**FESTA**

MŰANYAG SIMÍTÓ ERŐSÍTETT



R.sz.	leírás	
30003	270 x 125 mm	28
30004	235 x 115 mm	35
30005	210 x 115 mm	38
30007	210 x 60 mm	44



**FESTA**

FA SIMÍTÓ

· hársfa



R.sz.	leírás	
34005	400 x 145 mm	40
34007	290 x 145 mm	20



FA SIMÍTÓ

· nyárfa



R.sz.	leírás	
34006	400 x 145 mm	40



**FESTA**

MŰANYAG SIMÍTÓ ABS



R.sz.	leírás	
34041	280 x 140 - 2 mm	10
34051	280 x 140 - 3 mm	10
34053	280 x 140 - 3 mm fogak - e6	10



LEHÚZÓLÉC



R.sz.	leírás	
15889	980 x 380 mm nyél Ø 32 mm	1



LEHÚZÓGUMI

R.sz.	leírás	
15886	450 mm nyél Ø 23 mm	48
15887	600 mm nyél Ø 23 mm	48
15888	750 mm nyél Ø 23 mm	32



LEHÚZÓLÉC



R.sz.	leírás	
15885	100 x 800 mm nyél Ø 32 mm	1

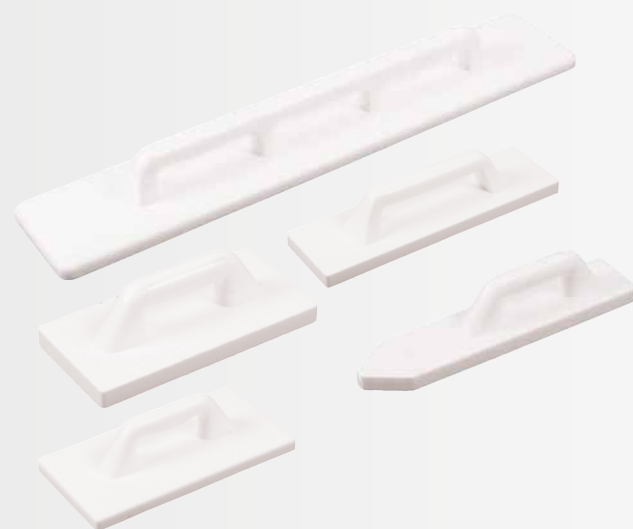

## PUR SIMÍTÓ



R.s.	leírás		R.s.	leírás	
34122	120 x 240 mm	50	34154	220 x 420 mm	15
34132	140 x 280 mm	40	34155	240 x 480 mm	15
34142	180 x 320 mm	25	34156	280 x 500 mm	10
34152	200 x 360 mm	20	34157	330 x 330 mm	5
34121	80 x 260 mm lesarkított	50	34158	120 x 800 mm	5
34153	100 x 400 mm	30	34159	120 x 1000 mm	5
			34160	120 x 1200 mm	5

## STYROHART SIMÍTÓ



R.s.	leírás	
34101	80 x 350 mm lesarkított	10
34061	130 x 270 mm	10
34111	170 x 320 mm	10
34071	130 x 450 mm	10
34081	140 x 750 mm	10
34091	140 x 900 mm	5



## PUR SIMÍTÓ



R.s.	leírás	
34115	140 x 280 mm	36
34116	180 x 320 mm	36
34117	200 x 360 mm	24
34118	220 x 420 mm	24

CSISZOLÓTUSKÓ  
GYORSRÖGZÍTŐS

R.s.	leírás	
34301	230 x 105 mm	1
34304	235 x 80 mm	1



FESTA®

## CSISZOLÓ TUSKÓ CSAVAROS

R.s.	leírás	
34200	210 x 115 mm	30
34201	240 x 105 mm	50
34202	240 x 80 mm	50



## CSISZOLÓ TUSKÓ NYELEZHETŐ

fogantyú 52030

ALU

R.s.	leírás	
34203	230 x 80 mm aluminium	1
52030	Teleszkopikus rúd	12

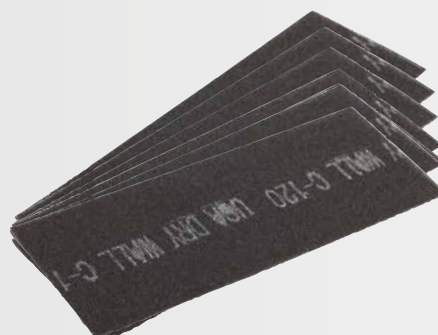

## CSISZOLÓ RÁCS 10 DB

10x

R.s.	leírás	
34271	115 x 290 mm kem. 120	80
34272	115 x 290 mm kem. 100	80
34273	115 x 290 mm kem. 80	80
34274	93 x 290 mm kem. 120	80
34275	93 x 290 mm kem. 100	80
34276	93 x 290 mm kem. 80	80



## CSISZOLÓ RÁCS 3 DB

3x



R.s.	leírás	
34280	115 x 290 mm kem. 120	20
34281	115 x 290 mm kem. 100	20
34282	115 x 290 mm kem. 80	20
34283	93 x 290 mm kem. 120	20
34284	93 x 290 mm kem. 100	20
34285	93 x 290 mm kem. 80	20

ANYAG FELÜLET	BETON		PLASTER				RAGASZTÓK ÉS FUGÁZÓ ANYAGOK	HOMLOKZATI RAGASZTÓ	HASZNÁLATA
	VASTAG	MÁZOLT	FAL VAKOLAT	FINOM BELSŐ	FINOM ÍTONG	FINOM HOMLOKZATI			
FEKETE FILC (BARNA, SZÜRKE)				••••		••			finom vakolat simítása, nagyobb vakolat szemcsékre
FEHÉR FILC				••••	••••	••••			finom vakolat simítása, kisebb vakolat szemcsékre
FINOM HABSZIVACS				••••	••••	••••			szabad homok eltávolítására, finom vakolatra, csempe lemosása fugázás után
DURVA HABSZIVACS				••••	••••	••••			szabad homok eltávolítására, durva vakolatra
RASZTERES HABSZIVACS				••••	••••	••••			szabad homok eltávolítására, raszter segítségével jobban felfogja a durva szemcséket, csempe lemosása fugázás után
TENGERI SZIVACS					•••		••••		fuga anyag lemosása
HYDRO SZIVACS DURVA, FINOM					•		••••		fuga anyag lemosása
SZIVACS				••	••••	••	••••		fuga anyag lemosása, finom vakolat végső tisztítása, vakolat lesimítása
MIKROGUMI							••••		fuga anyag benyomása a fugába
GUMI SZIVACS							••••		fuga anyag benyomása a fugába
MIRELON		••••	•••						beton megmunkálása, durva stukk vakolat megmunkálása
DUREN				••••	••	••••			finom vakolat egyenesítése, általánosan a vakolatok befejezésére
FA	••••	••••	••••						beton megmunkálása, durva stukk vakolat megmunkálása
ACÉL LAP	••	••••		••		••••	••		beton glettelés, elkenése, nehezen elérhető helyek
POLISZTIROL	•••	••••	•••	••		••			beton megmunkálása, durva stukk vakolat megmunkálása
POLYURETAN	••••	••••	••••						beton megmunkálása, durva stukk vakolat megmunkálása
ABS		••		••••	••••	••••	••••		ragasztó, vakolat, stukk vakolat felrakása
SIMA ROZSDAMENTES				••••	••••	••••	••••		ragasztó, vakolat, stukk vakolat felrakása
FOGAS ROZSDAMENTES							••••		ragasztó, vakolat, stukk vakolat felrakása
CSISZOLÓ SIMÍTÓ POLISZTIROLRA, MŰANYAG			••				••••		polisztirol csiszolása, cement ragasztók csiszolása
CSISZOLÓ SIMÍTÓ POLISZTIROLRA, FALAP			••				••••		polisztirol csiszolása, cement ragasztók csiszolása

**FESTA**

## FEHÉR FILCES SIMÍTÓ



R.sz.	leírás		R.sz.	leírás	
34400	280 x 140 x 8 mm	15	34450	220 x 130 x 8 mm	15
34415	250 x 130 x 8 mm	15	34445	220 x 70 x 8 mm	20

**FESTA**

## MŰANYAG SIMÍTÓ FEKETE FILCES



R.sz.	leírás		R.sz.	leírás	
34401	280 x 140 x 10 mm	15	34451	220 x 130 x 10 mm	15
34416	250 x 130 x 10 mm	15	34446	220 x 70 x 10 mm	20

**FESTA**

## KEMÉNY SZIVACCSOS SIMÍTÓ



R.sz.	leírás	
34441	280 x 140 x 12 mm	15
34440	250 x 130 x 12 mm	15

**FESTA**

## SZIVACCSOS SIMÍTÓ

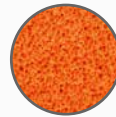

R.sz.	leírás		R.sz.	leírás	
34405	280 x 140 x 18 mm	15	34480	280 x 140 x 12 mm	15
34420	250 x 130 x 18 mm	15	34481	250 x 130 x 12 mm	15
34454	220 x 130 x 18 mm	15	34482	220 x 130 x 12 mm	15
34449	220 x 70 x 18 mm	20			

**FESTA**

## KEMÉNY SZIVACCSOS SIMÍTÓ



R.sz.	leírás	
34443	280 x 140 x 12 mm	15
34442	250 x 130 x 12 mm	15
34439	250 x 130 x 18 mm	15

**FESTA**

## SZIVACCSOS SIMÍTÓ



R.sz.	leírás		R.sz.	leírás	
34404	280 x 140 x 30 mm	10	34419	250 x 130 x 20 mm	10
34485	280 x 130 x 20 mm	10	34453	220 x 130 x 20 mm	10
34486	250 x 130 x 30 mm	10	34447	220 x 70 x 20 mm	10

**FESTA**

## SZIVACCSOS SIMÍTÓ HASÍTOTT



R.sz.	leírás	
34409	280 x 140 x 30 mm	10
34425	250 x 130 x 20 mm	10

**FESTA**

## KEMÉNY SZIVACCSOS SIMÍTÓ



R.sz.	leírás	
34410	280 x 140 x 30 mm	10
34426	250 x 130 x 20 mm	10





**FESTA**

TENGERI SZIVACOSOS SIMÍTÓ



R.sz.	leírás	
34406	280 x 140 x 30 mm	10
34421	250 x 130 x 30 mm	10
34455	220 x 130 x 30 mm	10



**FESTA**

TENGERI SZIVACOSOS SIMÍTÓ HASÍTOTT



R.sz.	leírás	
34413	280 x 140 x 30 mm	10
34428	250 x 130 x 30 mm	10



**FESTA**

SZIVACOSOS SIMÍTÓ



R.sz.	leírás	
34412	280 x 140 x 30 mm	10
34424	250 x 130 x 30 mm	10
34458	220 x 130 x 30 mm	10



**FESTA**

SZIVACOSOS SIMÍTÓ



R.sz.	leírás	
34490	280 x 140 x 30 mm	10
34491	250 x 130 x 30 mm	10



**FESTA**

SZIVACOSOS SIMÍTÓ



R.sz.	leírás	
34411	280 x 140 x 30 mm	10
34423	250 x 130 x 30 mm	10
34457	220 x 130 x 30 mm	10



**FESTA**

GUMIS SIMÍTÓ

R.sz.	leírás	
34402	280 x 140 x 10 mm	15
34417	250 x 130 x 10 mm	15
34452	220 x 130 x 10 mm	15



**FESTA**

MŰANYAG SIMÍTÓ MIKROGUMIVAL

R.sz.	leírás	
34403	280 x 140 x 8 mm	15
34418	250 x 130 x 8 mm	15
34496	220 x 130 x 8 mm	15



**FESTA**

SZIVACOSOS SIMÍTÓ DUREN



R.sz.	leírás	
34407	280 x 140 x 20 mm	10
34422	250 x 130 x 20 mm	10
34456	220 x 130 x 20 mm	10
34448	220 x 70 x 20 mm	10

**FESTA**
**SZIVACOSOS SIMÍTÓ DUREN**



R.sz.	leírás	
34414	280 x 140 x 20 mm	10
34429	250 x 130 x 20 mm	10
34459	220 x 130 x 20 mm	10
34479	220 x 70 x 20 mm	10

**FESTA**
**SIMÍTÓ**

R.sz.	leírás	
30003	270 x 125 mm	28
30004	235 x 115 mm	35
30005	210 x 115 mm	38
30007	210 x 60 mm	44

**FESTA**
**MŰANYAG SIMÍTÓ ERŐSÍTETT**

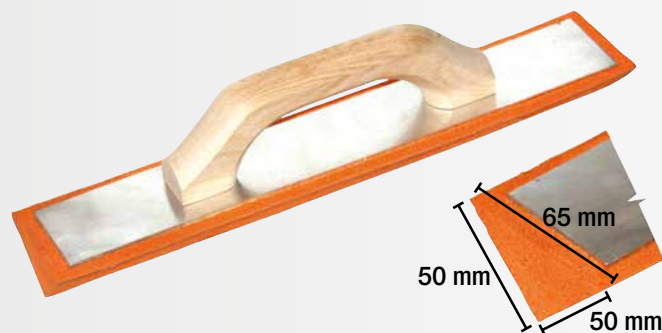
R.sz.	leírás	
34033	240 x 95 mm	5

**SZIVACOSOS SIMÍTÓ 90°**

R.sz.	leírás	
34500	350 mm	6

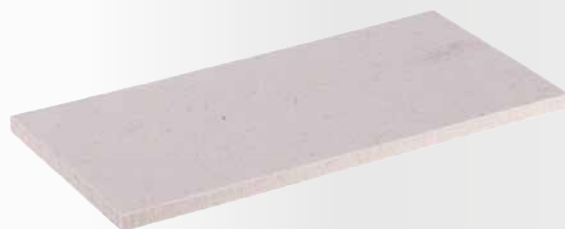
**PÓT FILC**

R.sz.	leírás	
34241	280 x 140 x 8 mm	1
34223	250 x 130 x 8 mm	1

**PÓT FILC**

R.sz.	leírás	
34243	280 x 140 x 10 mm	1
34221	250 x 130 x 10 mm	1

**PÓTSZIVACS**

R.sz.	leírás	
34262	280 x 140 x 18 mm	1

**PÓT SZIVACS**

R.sz.	leírás	
34251	280 x 140 x 30 mm	1



## PÓT SZIVACS



R.sz.	leírás	
34261	280 x 140 x 30 mm	1



## PÓT TENGERI SZIVACS



R.sz.	leírás	
34265	280 x 140 x 30 mm	1

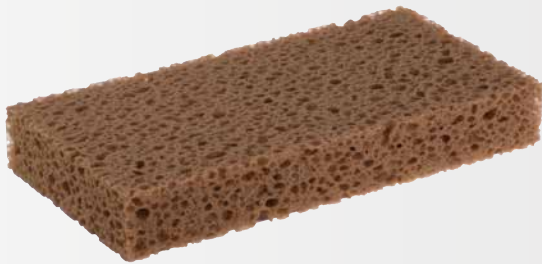

## PÓTSZIVACS



R.sz.	leírás	
34238	280 x 140 x 30 mm	1



## PÓTSZIVACS



R.sz.	leírás	
34237	280 x 140 x 30 mm	1
34235	250 x 130 x 30 mm	1



## PÓTGUMI



R.sz.	leírás	
34231	280 x 140 x 10 mm	1

**FESTA****ELEKTROMOS  
HABARCSKEVERŐ DUPLA**

Bemenet	1800 W
Feszültség / frekvencia	230 V / 50 Hz
Fogaskerekek	2
1. fokozat (alajjárati sebesség)	0 - 450 ot./min.
2. fokozat (alajjárati sebesség)	0 - 790 ot./min.
Túltöltés elleni védelem	Igen
Keverőkosár átmérője	100 mm
Seprű hossza	570 mm
Súly	5,6 kg



R.sz.	leírás	
35311	keverő	1
35318	tartalék szén	1
35319	tartalék keverők - pár (L + R)	1

**FESTA****ELEKTROMOS HABARCS ÉS FESTÉKKEVERŐ 850W**

Teljesítmény:	850 W
Hálózati feszültség:	230 V   50 Hz
Fokozatok száma:	1
1. Üresjárati fordulatszám:	0 - 500 ot./min.
2. Üresjárati fordulatszám:	-
Védelem:	Igen
Cérna:	M 14
Keverőlapát:	120 mm
Keverőlapát hossza:	600 mm
Tömeg:	3,7 kg

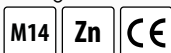

R.sz.	leírás	
35300		1
35316	tartalék szén	1

**FESTA****ELEKTROMOS HABARCS ÉS FESTÉKKEVERŐ 1600W**

Teljesítmény:	1600 W
Hálózati feszültség:	230 V   50 Hz
Fokozatok száma:	2
1. Üresjárati fordulatszám:	0 - 480 ot./min.
2. Üresjárati fordulatszám:	0 - 800 ot./min.
Védelem:	Igen
Cérna:	M 14
Keverőlapát:	140 mm
Keverőlapát hossza:	600 mm
Tömeg:	4,7 kg

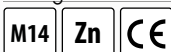

R.sz.	leírás	
35310		1
35317	tartalék szén	1

**FESTA****HABARCS KEVERŐSZÁR**

Bal kezes, órajárással ellentétes- nagy terjedelmű cementhabarcs keverésére.

**Zn M14**

R.sz.	leírás	
35085	M14 Ø 120 x 600 mm	12
35086	M14 Ø 140 x 600 mm	12
35087	M14 Ø 160 x 600 mm	12

**FESTA****HABARCS KEVERŐSZÁR**

Spiral mixer: -jobb kezes- nehezen keverhető anyagokhoz. Vakolóanyagok, mésztartalmú vakolatok, beton és bitumenes kötőanyagok keverésére.

**Zn M14**

R.sz.	leírás	
35091	M14 Ø 120 x 600 mm	12
35092	M14 Ø 140 x 600 mm	12
35093	M14 Ø 160 x 600 mm	12

**FESTA****KEVERŐSZÁR KÖRREL HORGANYZOTT**

Habarcsok, készvakolatok, csempereasztók, glett anyagok keverésére.

**Zn**

R.sz.	leírás	
35038	Ø 80 x 500 mm	24
35058	Ø 100 x 500 mm	24
35023	Ø 120 x 500 mm	24

**FESTA****HABARCS KEVERŐSZÁR**

Habarcsok, készvakolatok, csempereasztók, glett anyagok keverésére.

**SDS+ Zn**

R.sz.	leírás	
35094	Ø 80 x 500 mm	24
35095	Ø 100 x 500 mm	24
35096	Ø 120 x 500 mm	24

**FESTA****HABARCS KEVERŐSZÁR**

Habarcok, készvakolatok, csemeragasztók, glett anyagok keverésére.

**M14** **Zn**

R.sz.	leírás
35059	M14 Ø 90 x 550 mm

 24
**FESTA****KEVERŐSZÁR HORGANYZOTT**

Habarcok, készvakolatok, csemeragasztók, glett anyagok keverésére.

 **Zn**

R.sz.	leírás
35013	Ø 80 x 500 mm
35006	Ø 100 x 500 mm
35007	Ø 120 x 500 mm

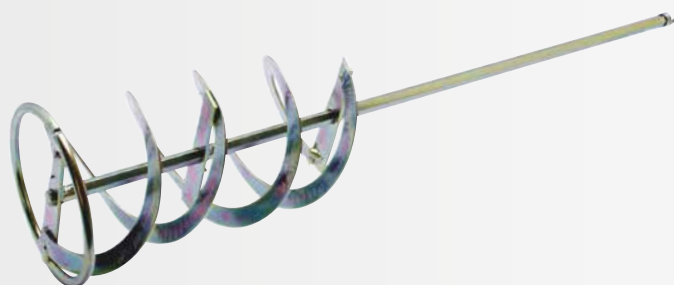
 24  
 24  
 24
**FESTA****KEVERŐSZÁR HORGANYZOTT**

Habarcok, készvakolatok, csemeragasztók, glett anyagok keverésére.

**SDS+** **Zn**

R.sz.	leírás
35012	Ø 100 x 500 mm

 24
**FESTA****HABARCS KEVERŐSZÁR**

Habarcok, készvakolatok, csemeragasztók, glett anyagok keverésére.

 **Zn**

R.sz.	leírás
35069	Ø 60 x 500 mm
35078	Ø 80 x 500 mm
35081	Ø 100 x 500 mm

 50  
 24  
 24

**FESTA****HABARCS KEVERŐSZÁR**

Habarcsok, készvakolatok, csemperagasztók, glett anyagok keverésére.

SDS+ Zn



R.sz.	leírás	
35070	Ø 60 x 500 mm	50
35079	Ø 80 x 500 mm	24
35082	Ø 100 x 500 mm	24

**FESTA****KEVERŐSZÁR KÖR NÉLKÜL HORGANYZOTT**

Habarcsok, készvakolatok, csemperagasztók, glett anyagok keverésére.

 Zn

R.sz.	leírás	
35048	Ø 70 x 500 mm	24
35068	Ø 90 x 500 mm	24

**FESTA****KEVERŐSZÁR HORGANYZOTT**

Habarcsok, készvakolatok, csemperagasztók, glett anyagok keverésére.

 Zn

R.sz.	leírás	
35021	Ø 100 x 500 mm	24

**FESTA****KEVERŐSZÁR, KALITKÁS, HORGANYZOTT**

glettanyagok, tömítőanyagok, ragasztók, habarcsok keverésére

 Zn

R.sz.	leírás	
35015	Ø 100 x 500 mm	20

**FESTA****KEVERŐSZÁR KÉT PROPELLERREL HORGANYZOTT**

folyékony anyagok, festékek, tapéta és csemperagasztók keverésére.



R.sz.	leírás	
35011	Ø 80 x 500 mm	50

**KEVERŐSZÁR**

Mindenfajta falfesték és diszperziós festék, ragasztók, beton, esztrich, cement keverésére.



R.sz.	leírás	
35125	Ø 60 x 400 mm	40
35126	Ø 80 x 400 mm	40
35127	Ø 100 x 600 mm	20

**KEVERŐSZÁR - FESTETT**

Mindenfajta falfesték és diszperziós festék, ragasztók, beton, esztrich, cement keverésére.



R.sz.	leírás	
35103	Ø 60 x 400 mm	40
35113	Ø 80 x 400 mm	40
35123	Ø 100 x 600 mm	20

**KÁBELDOB**

- Hosszabbító kábel 25 m-es tárcsával - IP20
- H05VV - F 3G 1,5mm<sup>2</sup>, - Hőbiztosítóval felszerelve
- Maximális megterhelés feltekert állapotban: 1000 W max.
- Maximális megterhelés kihúzott állapotban: 3000 W max.
- 4 gyermekzáras földelt csatlakozóval ellátva.



R.sz.	leírás	
37760	4 foglalat hossz 25 m, IP 20, 1,5 mm <sup>2</sup>	2
37761	4 foglalat hossz 50 m, IP 20, 1,5 mm <sup>2</sup>	2

**HOSSZABBÍTÓ KÁBEL**

R.sz.	leírás	
37730	max. 3680 W hossz 10 m, 1,5 mm <sup>2</sup>	8
37731	max. 3680 W hossz 20 m, 1,5 mm <sup>2</sup>	4



## ELEKTROMOS FŰTŐTEST

feszültség	230V ~50Hz
teljesítmény	3300W
Áramlási terhelés	14.5A
Teljesítménybeállítás	30/1650/3300W
Homérséklet tartomány	5-40°C
lefedettség	IP24
méret	27 x 25.5 x 40cm
súly	4.8 kg

- Pincék, muhelyek, üzletek, party sátrak, üvegházak, stb. gyors és hatékony futésére
- Nem fogyaszt oxigént
- Biztonságos működés, folyamatos teljesítmény-szabályozás, térbeli termosztát, ventilátor
- Futótest rozsdamentes acélból
- Nyári használatra szellőztetéshez, futás nélkül
- Alacsony zajszint
- Kiváló minőségű feldolgozás- és anyagok, robusztus acélszerkezet, könnyű és biztonságos kezelés, hosszú élettartam



R.s. leírás  
35833 3,3 kW



1

## GÁZMELEGÍTŐ

Gáz	G30-I3B/P
Gáznyomás	0.7bar
Névleges feszültség	230V 50Hz
Motorteljesítmény	25W
Maximális gázfogyasztás	1.11 kg/h
Maximális hoteljesítmény	15kW
Maximális forró levego mennyisége	300m3/h

- Gyors és hatékony futés az építési munkáknál, muhelyekben, stb.
- Oxigént fogyaszt!
- Közvetlen légfuto kényszerkeringéssel - gyors hobevitel
- Biztonságos működés, folyamatos teljesítményszabályozás
- Termosztát és biztonsági szelep a túlmelegedés és gázszivárgás ellen
- Tartozékokkal együtt - szabályozó és bemeneti gázcső
- Kiváló minőségű feldolgozás- és anyagok, robusztus acélszerkezet, könnyű és biztonságos használat, hosszú élettartam



R.s. leírás  
35845 15 kW



1

## GÁZMELEGÍTŐ

Gáz	G30-i3b/p
Gáznyomás	1.5bar
Névleges feszültség	230V 50Hz
Motorteljesítmény	70W
Maximális gázfogyasztás	2.2kg/h
Maximális hoteljesítmény	30kW
Maximális forró levego mennyisége	750m3/h

- Gyors és hatékony futés az építési munkáknál, muhelyekben, stb.
- Oxigént fogyaszt!
- Közvetlen légfuto kényszerkeringéssel - gyors hobevitel
- Biztonságos működés, folyamatos teljesítményszabályozás
- Termosztát és biztonsági szelep a túlmelegedés és gázszivárgás ellen
- Tartozékokkal együtt - szabályozó és bemeneti gázcső
- Kiváló minőségű feldolgozás- és anyagok, robusztus acélszerkezet, könnyű és biztonságos használat, hosszú élettartam



R.s. leírás  
35850 30 kW



1



Profi igényeket kielégítő betonkeverők  
Öntöttvas hajtó fogaskoszorú .... rögzítéssel  
Pórszóró felületek  
DIN EN ISO 9000-nak megfelelő minőség biztosítás  
Speciális formájú keverődob  
IP 45 splash biztos védelem  
220 V és 380 V-s meghajtás

## PROFI BETONKEVERŐK *Lescha*

**Lescha**  
BETONKEVERŐ



R.sz.	leírás	
35500	Star 150 - 125 l, 230 V fék	1



**Lescha**  
BETONKEVERŐ



R.sz.	leírás	
35502	EUROMIX 125 l, 230 V	1
35503	EUROMIX 125 l, 400 V	1



**Lescha**  
BETONKEVERŐ



R.sz.	leírás	
35501	BX 135 - 125 l, 230 V	1



**Lescha**  
BETONKEVERŐ



R.sz.	leírás	
35504	ABM 135 l, 230 V fék	1



**Lescha**  
BETONKEVERŐ



R.sz.	leírás	
35505	SM 145 S - 140 l, 230 V	1
35506	SM 145 S - 140 l, 400 V	1
35507	SM 145 S - 140 l, 230 V fék	1
35508	SM 145 S - 140 l, 400 V fék	1



**Lescha**  
BETONKEVERŐ



R.sz.	leírás	
35510	SM 165 S - 160 l, 230 V fék	1
35511	SM 165 S - 160 l, 400 V fék	1
35512	SM 165 S - 160 l, G benzín	1





**Lescha**  
BETONKEVERŐ



R.sz.	leírás	
35514	SM 185 S - 180 l, 230 V fék	1
35515	SM 185 S - 180 l, 400 V fék	1



**Lescha**  
BETONKEVERŐ



R.sz.	leírás	
35516	S 180 HR - 180 l, 230 V fék	1
35517	S 180 HR - 180 l, 400 V fék	1



**Lescha**  
BETONKEVERŐ



R.sz.	leírás		
35524	LB 354   230 V, 1,5 kW		1
35525	LB 354   400 V, 1,5 kW		1
35527	LB 354   Honda G200		1
35532	LB 404   230 V, 1,5 kW		1
35533	LB 404   400 V, 1,5 kW		1
35539	LB 484   Robin EH17B		1
35540	LB 484   Honda GX160LX		1
35542	AT 480   400 V, 1,2 kW		1



**Lescha**  
BETONKEVERŐ



R.sz.	leírás		
35552	LHB 1000   400 V		1
35553	LHB 1000   HATZ Diesel		1
35555	LHB 1200   400 V		1



**Lescha**  
BETONKEVERŐ



R.sz.	leírás	
35518	S 230 HR - 230 l, 230 V fék	1
35519	S 230 HR - 230 l, 400 V fék	1

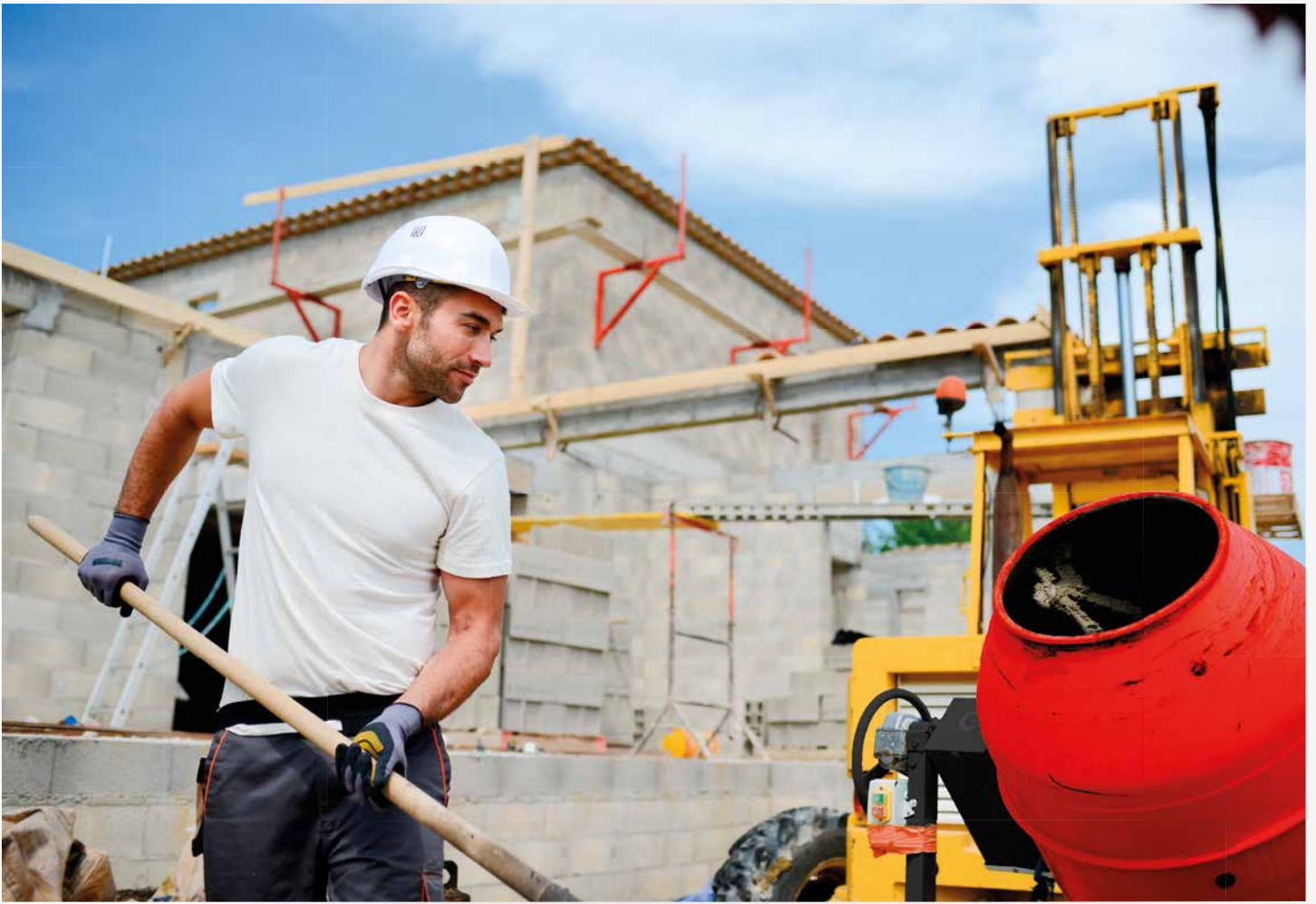

### 130 L

#### leírás

a dob térfogata	130 l
dob sebesség	26±Min <sup>-1</sup>
erő	700 W
feszültség	230 V / 50 Hz
a védelem mértéke	IP44
Koszorú anyaga	lotinóv
méretek	hossz 1170 mm lätíme 650 mm magasság 1280 mm
súly	53 kg

### 165 L

#### leírás

a dob térfogata	165 l
dob sebesség	23±Min <sup>-1</sup>
erő	900 W
feszültség	230 V / 50 Hz
a védelem mértéke	IP44
Koszorú anyaga	lotinóv
méretek	hossz 1295 mm lätíme 735 mm magasság 1440 mm
súly	70 kg



BETONKEVERŐ



R.sz.	leírás				
37500	MIX 130Zk	230 V	szétszerelt		1
37501	MIX 130Z	230 V	összeszerelt		1
37505	MK 165Bk	230 V	szétszerelt		1
37506	MK 165B	230 V	összeszerelt		1

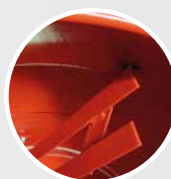

- Speciálisan kialakított lapátok, 4 mm-es vastagság



- Minőségi lábtartó fedéllel



- Kapcsoló biztonsági fedéllel



- Meghajtó műanyag fedéllel, öntöttvas koszorú

## BETONKEVERŐ



### 125 L

leírás	
a dob térfogata	125 l
dob sebesség	26±Min <sup>-1</sup>
erő	550 W
feszültség	230 V / 50 Hz
a védelem mértéke	IP44
Koszorú anyaga	lotinóv
méreték	hossz 1102 mm lätíme 690 mm magasság 1310 mm
súly	52,5 kg

R.s.	leírás		
37509	126 l, 230 V	összeszerelt	1
37510	126 l, 230 V	szétszerelt	1

### 162 L

leírás	
a dob térfogata	162 l
dob sebesség	26±Min <sup>-1</sup>
erő	650 W
feszültség	230 V / 50 Hz
a védelem mértéke	IP44
Koszorú anyaga	lotinóv   cast iron
méreték	hossz   lungíme 1180 mm lätíme   szélesség 710 mm magasság/ inaltíme 1310 mm
súly	56 kg

R.s.	leírás		
37515	162 l, 230 V	szétszerelt	1
37516	162 l, 230 V	összeszerelt	1

### 142 L

leírás	
a dob térfogata	142 l
dob sebesség	26±Min <sup>-1</sup>
erő	650 W
feszültség	230 V / 50 Hz
a védelem mértéke	IP44
Koszorú anyaga	lotinóv
méreték	hossz 1164 mm lätíme 690 mm magasság 1293 mm
súly	54 kg

R.s.	leírás		
37511	142 l, 230 V	szétszerelt	1
37512	142 l, 230 V	összeszerelt	1

### 180 L

leírás	
a dob térfogata	180 l
dob sebesség	26±Min <sup>-1</sup>
erő	850 W
feszültség	230 V / 50 Hz
a védelem mértéke	IP44
Koszorú anyaga	lotinóv   cast iron
méreték	hossz   lungíme 1164 mm lätíme   szélesség 690 mm magasság/ inaltíme 1368 mm
súly	58 kg

R.s.	leírás		
37517	180 l, 230 V	szétszerelt	1
37518	180 l, 230 V	összeszerelt	1

**Lescha**

CSÚSZDA ÉPÍTÉSI TÖRMELEKNEK

MADE IN  
EU

R.sz.	leírás	
35603	csepp alapátmérő 50/40 cm, hossza 108 cm PE (HDPE)	1
35604	PE építési törmelék (HDPE)	1
35605	tartókeret az építési törmelék garatkonformitása érdekében	1



TALICSKA



R.sz.	leírás	
37530	60 l, Ø 38 cm tömör gumi	1
37532	60 l, Ø 40 cm fúvott gumi	1



TALICSKA, HORGANYZOTT



R.sz.	leírás	
37527	80 l, Ø 40 cm fúvott gumi	1
37533	80 l, Ø 38 cm tömör gumi	1



TALICSKA PUTTONY



R.sz.	leírás	
37539	60 l	1



TALICSKA PUTTONY, HORGANYZOTT



R.sz.	leírás	
37541	80 l	1



PÓTKERÉK



R.sz.	leírás		
48729	typ AA 400	fúvott gumi	1
48730	typ AA 380	tömör gumiabroncs	1
48731	typ AA 380	tömör gumiabroncs (Slovakia)	1



HÁROM KEREKŰ TALICSKA



R.sz.	leírás		
37564	60 l		1

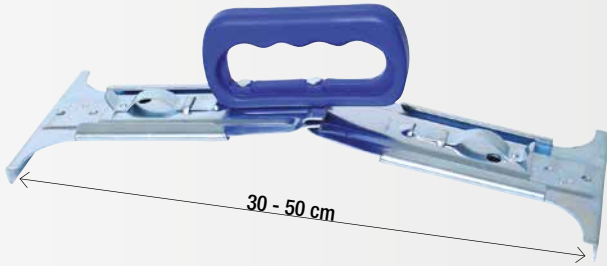

PADLÓCSEMPE TARTÓ

R.sz.	leírás	
36310	max. 20kg	5



SZEGÉLY HORDOZÓ

leírás	60115
befogható méret	80-370 mm
max. tömeg	50 kg



R.sz.	leírás	
60115	PRO 040	1



SZEGÉLY HORDOZÓ

leírás	60116
befogható méret	750-1000 mm
max. tömeg	120 kg



R.sz.	leírás	
60116	PRO 041	1



SZEGÉLY HORDOZÓ

leírás	60117	60118
befogható méret	500-1000 mm	0-500 mm
max. tömeg	150 kg	150 kg



R.sz.	leírás	
60117	PRO 042	1
60118	PRO 043	1



SOR EGYENGETŐ KALAPÁCS

leírás	60121	60123
magasság:	200 mm	200 mm
szélesség:	70 kg	70 kg
hossz:	870 mm	450 mm
súly:	2,5 kg	2,2 kg



R.sz.	leírás	
60121	870 mm	1
60123	450 mm	1



BURKOLAT ALÁTÉTT



R.sz.	leírás	
37166	D10 basic	25

NEW



FESTA

## ÁLLÍTHATÓ BAK

· max. terhelés 590 kg

R.s. Leírás

23657



1

NEW



FESTA

## HORDOZHATÓ ÁLLVÁNYOS SATU

· tartomány: 0 - 95 cm

· maximális teherbírás: 250 kg

R.s. Leírás

37553



1





MOLNÁRKOCSI

R.sz.	leírás	noszt	
48719	kerék 260 mm bantam	250 kg	1

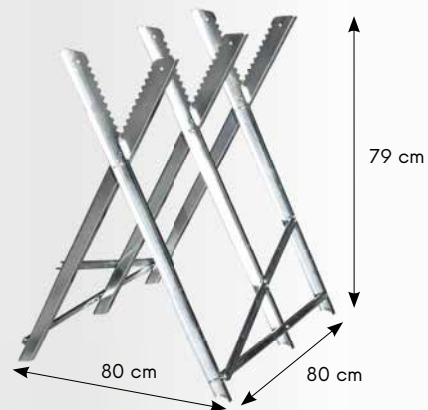

ÁLLÍTHATÓ BAK

R.sz.	leírás	
37570	max. 150 kg	1

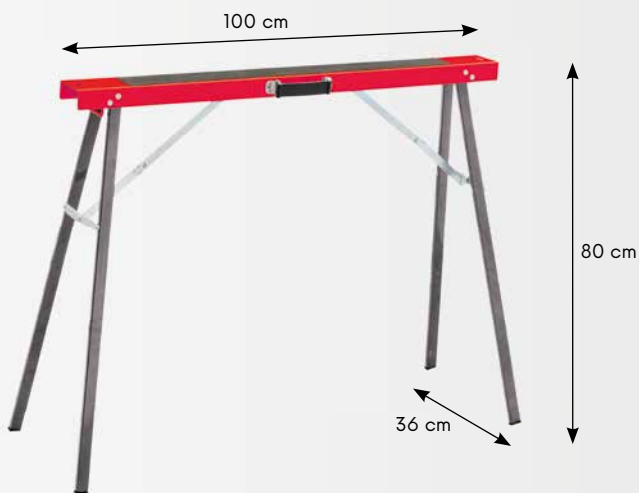

ÁLLÍTHATÓ BAK

max. terhelés 125 kg

2x

R.sz.	leírás	
37549	pár	1



ÁLLÍTHATÓ BAK - MŰANYAG

max. terhelés 150 kg (300 kg a kezében)

2x

R.sz.	leírás	
37560	pár	1

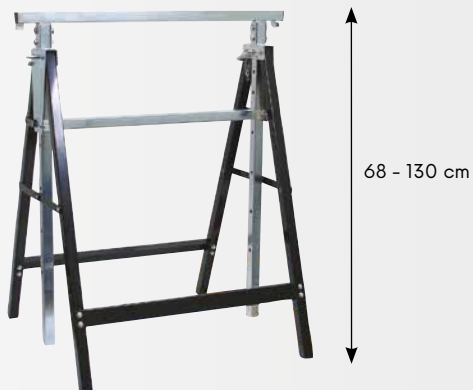

ÁLLÍTHATÓ BAK

R.sz.	leírás	
36300	68 - 130 cm, max. 125 kg	1



ÁLLÍTHATÓ BAK



R.sz.	leírás	
37545	140 cm, magasság 98 - 165 cm	1
37546	120 cm, magasság 98 - 165 cm	1

## PROFI CSEMPEVÁGÓ

- Legigényesebb profi csempevágó.
- A mozgás 9 STK golyóscsapággal történik
- A mozgástér behatárolása végett ebből négy állítható.
- Alárugózott (lökés csillapított) asztal.
- Pót alkatrészek és szervíz biztosított.
- Króm-wolfrám acélos vágókerekek.



**SUPER PRO**



## CSEMPEVÁGÓ SUPER PRO "EVO"

· 36195 Tartalék vágó kerék - Ø 22 mm



R.sz.	leírás
36191	1250 mm



1

**SUPER PRO**



## CSEMPEVÁGÓ

· 36195 Tartalék vágó kerék - Ø 22 mm



R.sz.	leírás
36145	SUPER PRO 450 mm
36160	SUPER PRO 600 mm
36175	SUPER PRO 750 mm
36190	SUPER PRO 900 mm



1



## CSEMPEVÁGÓ BASIC PLUS

· 36261 Tartalék vágó kerék - Ø 15 mm



R.sz.	leírás	
36240	400 mm	1



· illustrative photo

## BEMUTATÓ ÁLLVÁNY SUPER PRO



R.sz.	leírás	
36200	állvány	1
36199	állni a étel 36160, 36175, 36190	1



**FESTA**

## CSEMPEVÁGÓ "X"

· 36138 Tartalék vágó kerék - Ø 22 mm



R.sz.	leírás	
36085	600 mm	1
36087	900 mm	1
36086	1300 mm	1



**FESTA**

## CSEMPEVÁGÓ

· 36195 Tartalék vágó kerék - Ø 22 mm



R.sz.	leírás	
36080	600 mm	1
36081	750 mm	1
36082	900 mm	1
36076	750 mm összeszerelt	1
36077	900 mm összeszerelt	1

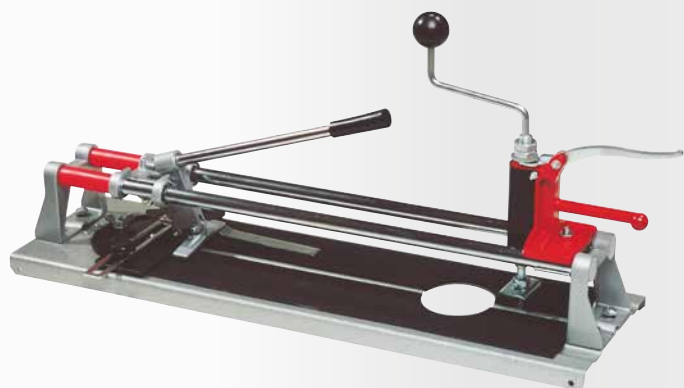

## CSEMPEVÁGÓ KÖRKIVÁGÓVAL

• 36128 Tartalék vágó kerék - Ø 16 mm



R.sz.	leírás
36014	480 mm



4

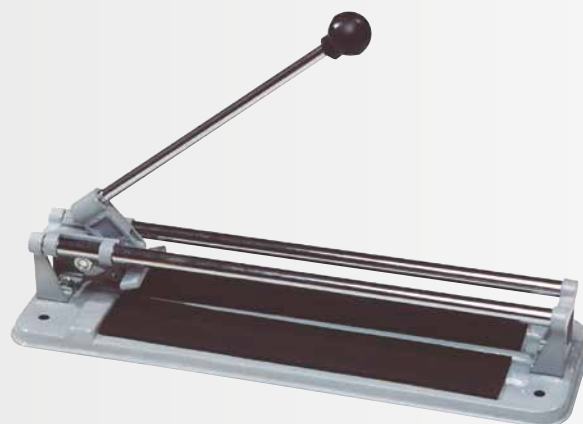

## CSEMPEVÁGÓ

• 36126 Tartalék vágó kerék - Ø 15 mm



R.sz.	leírás
36024	300 mm
36034	400 mm
36035	600 mm



10

10

4



## CSEMPEVÁGÓ

• 36136 Tartalék vágó kerék - Ø 22 mm



R.sz.	leírás
36036	480 mm



1



## KÉZI CSEMPEVÁGÓ

• 36136 Tartalék vágó kerék - Ø 22,2 mm



R.sz.	leírás
36046	22 mm



1



## TARTALÉK VÁGÓ KERÉK

R.sz.	leírás
36126	a= Ø 15 mm, b= Ø 6 mm, c= 1,5 mm
36128	a= Ø 16 mm, b= Ø 6 mm, c= 3 mm
36130	a= Ø 20 mm, b= Ø 6 mm, c= 5 mm
36136	a= Ø 22 mm, b= Ø 6 mm, c= 2 mm



1

1

1

1



## SZÚRÓFŰRÉSZ LAP KERÁMIÁHOZ, BOSCH

R.sz.	leírás
24055	Karbid - BOSCH, MAKITA

1

1

**FESTA****CSEMPEFOGÓ**

R.sz.	leírás
36057	200 mm



6

**CSEMPE (VÁGÓ-LETÖRŐ) FOGÓ**

R.sz.	leírás
36056	



10

**CSEMPE (VÁGÓ-LETÖRŐ) FOGÓ**

R.sz.	leírás
36059	



1

**CSEMPECSÍPÓ FOGÓ**

R.sz.	leírás
36058	200 mm



6



37028



37029

**SZIVACSKOCKA 160 X 110 X 60 MM**

R.sz.	leírás
37028	szivacsos
37029	tengeri szivacsokocka



1



37025



37026

**SZIVACSKOCKA 200 X 100 X 100 MM**

R.sz.	leírás
37025	finom szivacsokocka
37026	tengeri szivacsokocka



1

**BURKOLÓ VÖDÖR**

R.sz.	leírás
37117	klt
90070	vödör 25 l

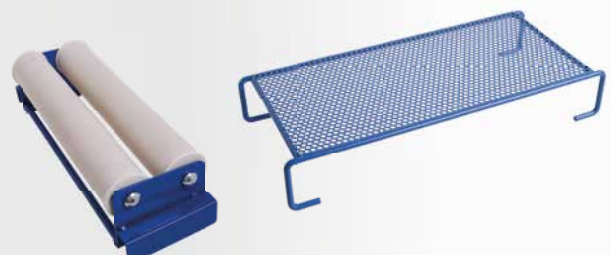

1

**RÁCS, LEHUZÓ HENGEREK**

R.sz.	leírás
90072	rács
90071	lehuzó hengerek



1



## FUGA TISZTÍTÓ

R.sz.	leírás
37012	



1



## FUGA TISZTÍTÓ

R.sz.	leírás	
37006	30 mm	20
37007	50 mm	20
37008	tartalék penge 30 mm	50
37009	tartalék penge 50 mm	50



## FUGA ELTÁVOLÍTÓ KLT.

3x

R.sz.	leírás
16042	



12

**FESTA**

## SZILIKON FUGAKIHÚZÓ

R.sz.	leírás
16056	145 mm



50



## SZILIKON FUGAKIHÚZÓ

4x

R.sz.	leírás
37053	



48



## SZILIKON FUGAKIHÚZÓ

R.sz.	leírás
37054	



1



## SZILIKON FUGAKIHÚZÓ

for joining of windows

R.sz.	leírás
37055	



1

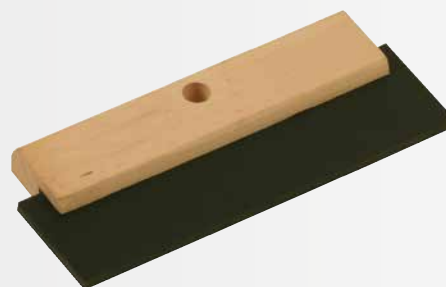

## FUGÁZÓ GUMI

R.sz.	leírás	
37011	180 mm	12
37021	280 mm	12

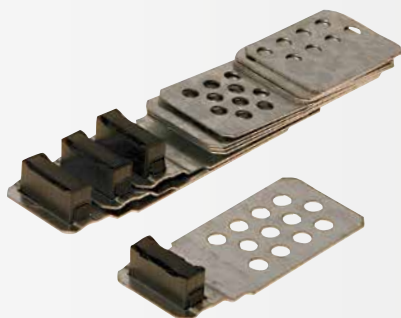

CSEMPEMÁGNES



R.s. 38920 1



CSEMPEMÁGNES, ÁLLÍTHATÓ



R.s. 38923 24

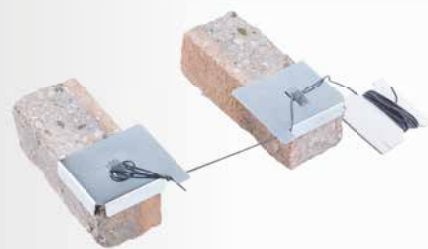

ÉPÍTÉSI SAROK KLT.



R.s. 38919 50



**FESTA**

LAMINÁTLAG VÁGÓ



R.s. 36140 leírás 210 mm



4



PARKETTÁZÓ KLT.

24x

R.s. 52130 1



MŰ. ÉEK

50x

R.s.	leírás	db	
37210	95 x 45 x 15 - 0 mm	50	1
37211	70 x 30 x 8 - 0 mm	50	1



FELFÚJHATÓ ÉK

· méret 15x17 cm  
· max. magasság . 5 cm

R.s. 37220 1

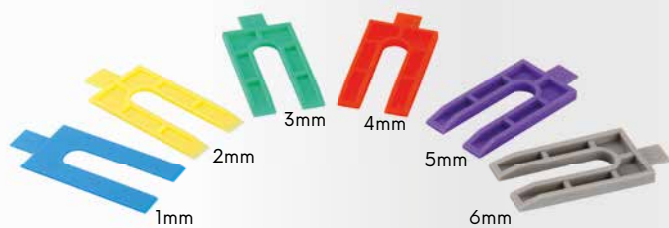

## TÁVTARTÓK

30x

R.sz.	leírás	db
37212	1 - 6 mm, 5x bármilyen méretű	1



FESTA

## FA ÉKEK



R.sz.	leírás	db
37204	55 x 20 x 0 - 6 mm	20
37203	65 x 18 x 0 - 12 mm	20
37202	80 x 25 x 3 - 10 mm	20
37201	100 x 25 x 1 - 16 mm	14
37200	150 x 25 x 1 - 25 mm	8
37205	55 x 8 x 0 - 10 mm	250



## FUGÁZÓ PISZTOLY



R.sz.	leírás	db
38026	5x fém hegy	1



## FUGA KINYOMÓ TASAK



R.sz.	leírás	db
38042	3x fém hegy	1



NIVELYS

## MŰANYAG FUGAKERESZT



100x

R.sz.	leírás	db
37195	1,0 mm	100
37196	1,5 mm	100
37197	2 mm	100
37198	3 mm	100



FESTA

## MŰANYAG FUGAKERESZT



R.sz.	leírás	db		R.sz.	leírás	db	
37148	1,0 mm	200	100	37152	3 mm	150	100
37149	1,5 mm	200	100	37153	4 mm	100	100
37150	2 mm	200	100	37154	5 mm	75	100
37151	2,5 mm	200	100	37158	10 mm	30	100



FESTA

## MŰANYAG CSEMPEÉK



R.sz.	leírás	db
37155	0 - 8 mm	30
37156	0 - 4 mm	100
37157	2,5 - 8 mm	30



FESTA

## MŰANYAG CSEMPEÉK

250x



R.sz.	leírás	db
37205	55 x 8 x 0 - 10 mm	250



**NEW**



**CSEMPESZINTEZŐ KÉSZLET**

**50x**

R.sz.	leírás
37199	1,5 mm



**NIVELYS MENETES TÁVTARTÓ KAPCS**

**50x**

R.sz.	leírás
37131	1 mm
37132	2 mm



**NIVELYS SZINTEZŐ KALAP**

**50x**

R.sz.	leírás
37130	



**NIVELYS**  
LEVELING SYSTEM **FESTA®**

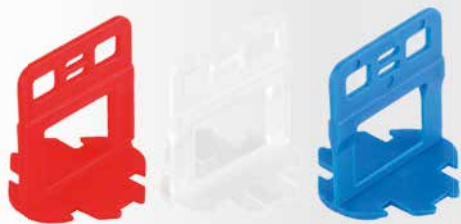

## NIVELYS TÁVTARTÓ KAPU

kiegyenlítő ékek 37175, 37176

50x



R.sz.	leírás	db	
37170	1 mm	50	60
37171	2 mm	50	60
37172	3 mm	50	60

NEW

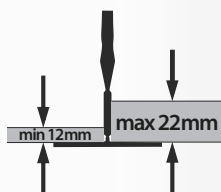

## NIVELYS TÁVTARTÓ KAPU

100x



R.sz.	leírás	db
37162	1,5 mm	1



## NIVELYS KIEGYENLÍTŐ ÉKEK

R.sz.	db	
37175	50	40
37176	400	3



## NIVELYS TÁVTARTÓ KAPU

600x



R.sz.	leírás	db	krabice	
37125	1 mm	600	38 x 28 x 19 cm	1
37126	1,5 mm	600	38 x 28 x 19 cm	1
37127	2 mm	600	38 x 28 x 19 cm	1

## NIVELYS TÁVTARTÓ KAPU

100x



R.sz.	leírás	db		R.sz.	leírás	db	
37185	1 mm	100	1	37187	3 mm	100	1
37190	1,5 mm	100	1	37188	4 mm	100	1
37186	2 mm	100	1	37189	5 mm	100	1



**NIVELYS**  
LEVELING SYSTEM **FESTA**

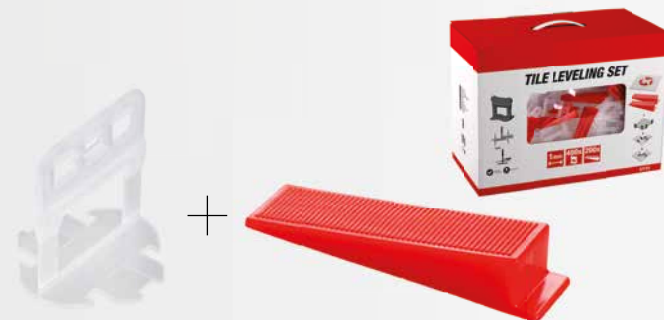

## NIVELYS TÁVTARTÓ KAPU + KIEGYENLÍTŐ ÉK

R.sz.	leírás	db	
37173	1 mm,	400 db + 200 db	1
37174	1,5 mm,	400 db + 200 db	1



**NIVELYS**  
SZINTEZŐ FOGÓ

R.s.  
37177



1



**NIVELYS**  
SZINTEZŐ FOGÓ

R.s.  
37178



1



**NEW**



**FESTA**  
VÁKUMOS SZÍVÓKORONG

durva és strukturált felületek

R.s. Leírás  
36325 max. 220 kg



1

**FESTA****PORFESTÉK 180 G**

R.sz.	leírás	
37096	kék	10
37094	fény kék	10
37097	piros	10
37095	fény piros	10
37098	fekete	10

**FESTA****KICSAPÓ ZSINÓR 30 M + FESTÉK POR 120 G**

· 6x gyorsabb tekerseleő mechanika  
· függőn funkció

R.sz.  
**37070**

6

**FESTA****KICSAPÓ ZSINOR KLT. 150 G**

· 5x gyors csévéelés

R.sz.  
**37065**

6

**KICSAPÓZSINÓR KLT. 180 G**R.sz.  
**37069**

10

**KICSAPÓZSINÓR - MŰANYAG ABS**R.sz.  
**37067**

25

**KICSAPÓZSINÓR - MŰANYAG**R.sz.  
**37066**

25

**KICSAPÓZSINÓR****ALU**R.sz.  
**37068**

25



**FESTA**

KŐMŰVES ZSINÓR - PIROS



R.sz.	leírás	
38895	50 m	24
38896	100 m	24

**FESTA**

KŐMŰVES ZSINÓR - SÁRGA



R.sz.	leírás	
38899	50 m	24
38900	100 m	24



**FESTA**

KŐMŰVES ZSINÓR 50 M



R.sz.	leírás	
38907	piros 1,0 mm	100
38908	piros 1,7 mm	100
38909	piros 2,0 mm	100

**FESTA**

KŐMŰVES ZSINÓR 50 M



R.sz.	leírás	
38904	sárga 1,0 mm	100
38905	sárga 1,7 mm	100
38906	sárga 2,0 mm	100



**FESTA**

KŐMŰVES ZSINÓR 50 M



R.sz.	leírás	
38910	narancs 1,0 mm	100
38911	narancs 1,7 mm	100
38912	narancs 2,0 mm	100

**FESTA**

KŐMŰVES ZSINÓR 50 M



R.sz.	leírás	
38901	fehér 1,0 mm	100
38902	fehér 1,7 mm	100
38903	fehér 2,0 mm	100

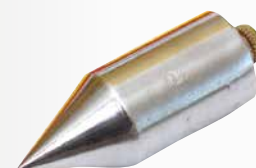

VIASZOLT ZSINEG



R.sz.	hossz	∅	
50920	50 m	1 mm	80

**FESTA**

FÜGGŐÓN - ZSINÓRRAL  
15 M



R.sz.	leírás	
38916	150 g	10
38917	300 g	6
38918	500 g	5

**FESTA**

FÜGGŐÓN



R.sz.	leírás	
38913	150 g	10
38914	300 g	10
38915	500 g	10

NEW

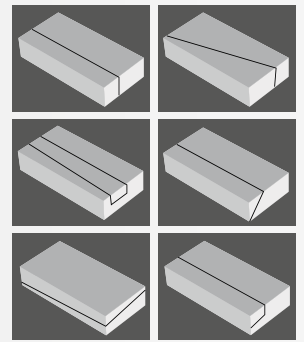

137 cm

FESTA

## POLISZTIROL VÁGÓ

- tápfeszültség: 230 V/50 Hz
- teljesítmény: 160 W
- vágás hossz: 137 cm
- vágási vastagság: 30 cm
- Védettség: IP44
- Vágási szög: 0° - 90°
- felszerelés: állvány, lábkapcsoló, állványtartó, 2x Ni-Cr vágóhuzal, tisztító sárgaréz kefe, számszámok és rögzítők, műanyag doboz kerekkel



R.s. Leírás

35348



1

NEW



1,7 m

FESTA

LÁB KAPCSOLÓ  
POLISZTIROL VÁGÓHOZ

- 35330, 35345, 35348 esetén

R.s. Leírás

35334



1

NEW



FESTA

ÁLLVÁNY  
POLISZTIROL VÁGÓHOZ

- 35330, 35345, 35348 esetén

R.s. Leírás

35336



1

NEW



FESTA

CSERERUGÓ  
POLISZTIROL VÁGÓHOZ

- 35330, 35345, 35348 esetén

R.s. Leírás

35332



1

NEW



FESTA

ÁLLVÁNYTARTÓ  
POLISZTIROL VÁGÓHOZ

- 35330, 35345, 35348 esetén

R.s. Leírás

35333



1

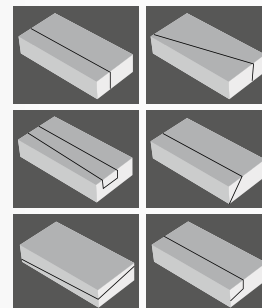
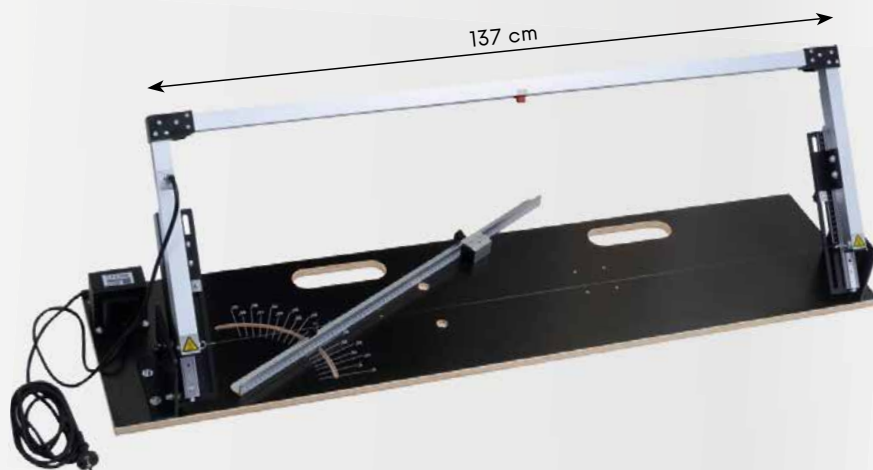

**FESTA**

**POLISZTIROL VÁGÓ**

- tápfeszültség: 230 V / 50 Hz
- teljesítmény: 160 W
- vágás hossz: 137 cm
- vágási vastagság: 30 cm
- Védettség: IP44
- Vágási szög: 0° - 90°



· Felszereltség: Ni - Cr vágószál, tisztító rézkefe, imbusz



R.sz.	leírás	
35345	Polisztirol vágó 1500 x 450 mm	1
35346	Csere vágószál Ni - Cr	1
35347	Tartalék tápegység	1

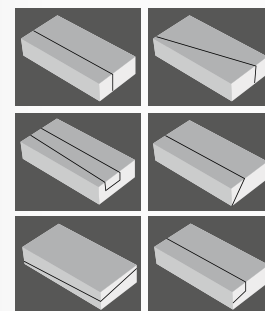
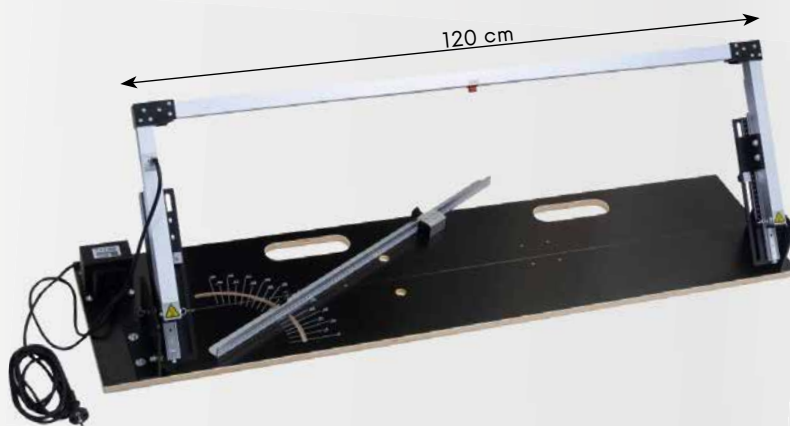

**FESTA**

**POLISZTIROL VÁGÓ**

- tápfeszültség: 230 V / 50 Hz
- teljesítmény: 160 W
- vágás hossz: 120 cm
- vágási vastagság: 30 cm
- Védettség: IP44
- Vágási szög: 0° - 90°



· Felszereltség: Ni - Cr vágószál, tisztító rézkefe, imbusz



R.sz.	leírás	
35330	Polisztirol vágó 1350 x 450 mm	1
35331	Csere vágószál Ni - Cr	1
35347	Tartalék tápegység	1

**FESTA****VEZETÉK NÉLKÜLI POLISZTIROL VÁGÓ**

- akkumulátor 36 V, 1,5 Ah Li-ion
- teljesítmény 180 W
- hőmérséklet max 350 C°
- penge hossz 20 cm



· felszerelés: 2 elem, töltő, penge, tisztító sárgaréz kefe, hatlapú

R.s. leírás  
**35323**



1

**FESTA****ELEKTROMOS PORISZTIROL VÁGÓ**

- tápfeszültség 230 V / 50 Hz
- teljesítmény 250 W
- hőmérséklet 50-600 C°
- penge hossz 25 cm
- tápkábel hossza 3 m



· Felszereltség: tisztító rézkefe, imbusz, pengék 25 cm, tartó doboz

R.s.	leírás	
<b>35326</b>	Elektromos porisztírol vágó	1
<b>35328</b>	pót penge 14 cm	1
<b>35329</b>	pót penge 25 cm	1

**VEZETŐ SABLON**

R.s.	leírás	
<b>35327</b>	vezető sablon	1
<b>35335</b>	pót penge - 30 cm	1



1

**FESTA****ELEKTROMOS PORISZTIROL VÁGÓ**

· temperature regulation

R.s. leírás  
**35325** 220 W



1





**NEW**



**FESTA**

**POLISZTIROL KÖRKIVÁGÓ**

**ALU**

R.sz.	leírás	
24752	Ø 65 mm	1
24753	Ø 70 mm	1

**NEW**



**CSAVAROS TIPLI SZIGETELÉSHEZ**

**2x**

R.sz.	leírás	
39240	fehér	M10 1
39241	szürke	M10 1
39242	antracit	M10 1
39243	Barna	M10 1
39244	fekete	M10 1



**POLISZTIROL KÖRKIVÁGÓ**

R.sz.	leírás	
24727	Ø 65 mm	1
24729	Ø 68 mm	1
24728	Ø 70 mm	1



**DÚBEL**

**100x**

**MADE IN EU**

R.sz.	leírás		R.sz.	leírás	
39210	Ø 10 x 100 mm	1	39218	Ø 10 x 180 mm	1
39212	Ø 10 x 120 mm	1	39217	Ø 10 x 200 mm	1
39214	Ø 10 x 140 mm	1	39219	Ø 10 x 220 mm	1
39216	Ø 10 x 160 mm	1			

**NEW**



**SZIGETELÉS ALÁTÉT**

Ø 6 és 8 mm-es csavarokhoz

**50x**

R.sz.	leírás	
39208	Ø 68 mm	1



**SZIGETELÉS ALÁTÉT**

R.sz.	leírás	
39206	Ø 40 mm	200
39207	Ø 60 mm	100



### ÉLVÉDŐ PVC.



R.sz.	leírás	
39238	3 m	25



### PAPÍR ÉLVÉDŐ



R.sz.	leírás	
39245	AL 30 m x 5 cm	1



### SZIGETELÉS ALÁTÉT



R.sz.	leírás	
42420	Ø 30 mm	1



### RABICHÁLÓ



R.sz.	leírás	
42312	1 m   50 bm 16 x 16 mm	1



### MŰGYANTA HENGER



R.sz.	diameter	spike height	hossz	
38950	Ø 69 mm	12 mm	25 cm	10
38951	Ø 69 mm	12 mm	40 cm	8
38952	Ø 122 mm	34 mm	25 mm	10
38953	Ø 122 mm	34 mm	40 cm	8
38954	Ø 122 mm	34 mm	60 mm	4



### TÜSKÉSTALP



R.sz.	leírás	
38970	tüské 25 mm	1
38971	tüské 30 mm	1



GIPSZKARTONÓZÓ SZETT, KOMPLET KLT.

R.sz.	leírás	
34300	Gipszkarton készlet 9 db	10
34303	kádacska	60



GIPSZKARTON EMELŐ

· 153 - 344 cm  
· 54 kg

R.sz.	leírás	
26775		1



**FESTA**

GIPSZKARTON HORDOZÓ

2x



R.sz.	leírás	
36312		12



**FESTA**

GIPSZKARTON HORDOZÓ

R.sz.	leírás	
36308	36 x 16,5 x 7,5 cm	10

**NEW**



GLETTELŐ HENGER

· fogantyú 180 mm - 52630  
· fogantyú 250 mm - 52625  
· hosszú fogantyú 52010, 52011, 52012, 52020, 52030



R.sz.	leírás	
52611	250 mm	50
52612	180 mm	10



## KŐPORSZORÓ

Zn

R.s.  
37114

1



## KŐPORSZORÓ

Zn

R.s. leírás  
37115

1

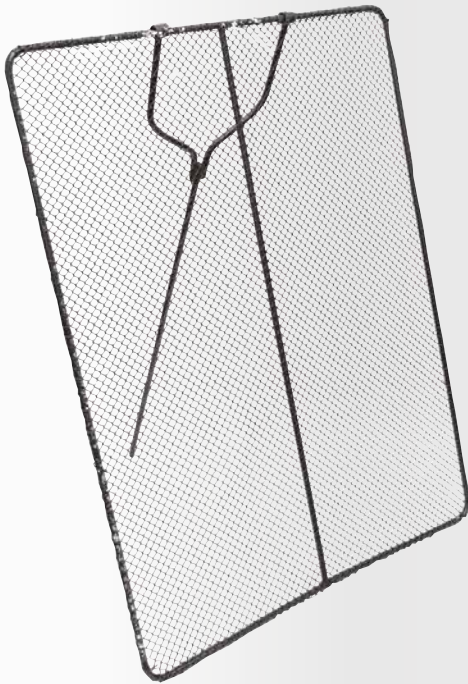

## FERDE SZITA

R.s.	szélesség	magas	szem háló	
37236	0,8 m	1 m	10 mm	1
37237	0,8 m	1 m	12 mm	1
37238	0,8 m	1 m	16 mm	1
37239	0,8 m	1 m	20 mm	1

SZITA  
MADE IN EU

R.s.	szélesség	magas	szem háló	
37216	50 mm	50 mm	2 mm	1
37217	50 mm	50 mm	3 mm	1
37218	50 mm	50 mm	4 mm	1



## FA ÖLESLÉC



R.s.	hossz	vastagság	szélesség	
37120	200 mm	1,7 mm	20 mm	10
37119	250 mm	1,7 mm	20 mm	10

MOQ  
10

10

10



ÉPÜLET HÁLÓ

R.sz.	leírás		
42120	2,5 x 20 m, 80 g/ m <sup>2</sup>	ZÖLD	5



SZÁLERŐSÍTÉS ROST AG. BETONHOZ

- +/- 150 g/ 50 kg cement
- 600 - 900 g/m<sup>2</sup> beton vagy habarcs



R.sz.	leírás		
42115	0,9 kg		9

SZERELŐ ABLAK MÁGNESES



R.sz.	leírás		
82105	25 x 25 cm		1



KAMPÓSSZEG



R.sz.	leírás		
37229	14,5 cm		10



KAMPÓSSZEG HORGANYZOTT



R.sz.	leírás		
37231	14 cm		10



KOVÁCSOLT KAMPÓSSZEG



R.sz.	leírás		
37232	14,5 cm		5



KOVÁCSOLT KAMPÓSSZEG



R.sz.	leírás		
37230	16 cm		6



ÁCSKAPOCS



R.sz.	leírás		
37233	320 x 10 mm		100
37234	320 x 12 mm		100



ÁCSKAPOCS



R.sz.	leírás		
37235	250 x 12 mm		1



## GÁZÉGETŐK

**FESTA**

## GÁZÉGETŐ

· Ø 17, 22, 40 mm



R.sz. leírás

69918 2 kW, 1,5 m Tömlő



10

**FESTA**

## GÁZÉGETŐ

· Ø 25, 35, 50 mm



R.sz. leírás

69919 19,5 kW, 1,5 m Tömlő



10

**FESTA**

## GÁZÉGETŐ

· Ø 55 mm



R.sz. leírás

69904 60 kW, 850 mm, 5 m Tömlő



8



**FESTA**  
GÁZÉGETŐ



R.sz.	leírás
69914	300 mm + 2 m Tömlő



5



**FESTA**  
ÉG GÁZÉGETŐ Ó



R.sz.	leírás
69900	Ø 35 mm, hossz 300 mm, Tömlő nélkül
69901	Ø 35 mm, hossz 300 mm + 3 m Tömlő



5



**FESTA**  
GÁZÉGETŐ



R.sz.	leírás
69902	Ø 55 mm, hossz 550 mm, Tömlő nélkül



10



**FESTA**  
GÁZÉGETŐ



R.sz.	leírás
69903	Ø 55 mm, hossz 550 mm + 3 m Tömlő



10



**FESTA**  
ÉG GÁZÉGETŐ Ó



R.sz.	leírás
69905	Ø 55 mm, hossz 850 mm, Tömlő nélkül



10



**FESTA**  
ÉG GÁZÉGETŐ Ó



R.sz.	leírás
69906	Ø 55 mm, hossz 850 mm + 3 m Tömlő



5

**FESTA****GÁZÉGETŐ**

· propán-bután redukáló szelep 10 a 33 kg



R.sz.	leírás
69917	Ø 60 mm, hossz 900 mm + 3 m Tömlő 3 m



1

**FESTA****TÖMLŐ GÁZÉGETŐHÖZ**

R.sz.	leírás
69910	3 m
69911	5 m
69912	10 m



20

12

8

**FESTA****GÁZLÁMPA, PIEZZÓS, HÁZ NÉLKÜL**

· max. hőmérséklet	1200 °C
· erő	1,7 kW
· égő átmérője	Ø 20 mm



R.sz.	leírás
69930	piezo

20

**FESTA****GÁZLÁMPA, PIEZZÓS**

· max. hőmérséklet	1200 °C
· erő	1,7 kW
· égő átmérője	Ø 20 mm



R.sz.	leírás
69931	piezo

12





PROPÁN-BUTÁN REDUKTOR



R.s. leírás  
69923 W 21,8; G 3/8; 4 bar

1



PROPÁN-BUTÁN REDUKTOR

kimeneti nyomás	4,0 bar
névleges áramlási sebesség	16 kg   h
bemeneti csatlakozás	W 21,8 x 1   14" LH
kimeneti csatlakozás	G3   8" LH



R.s. leírás  
69920

25



NYOMÁSSZABÁLYZÓ

bemeneti csatlakozás	25 bar
kimeneti nyomás	0,5 - 4,0 bar
névleges áramlási sebesség	16 kg   h
bemeneti csatlakozás	W 21,8 x 1   14" LH
kimeneti csatlakozás	G3   8" LH



R.s. leírás  
69907

1



EGYIRÁNYÚ SZELEP

G 3/8L, 2 kg-os palackhoz



R.s. leírás  
69928

1



REDUKTOR



R.s.	leírás	
69908	30 mBar, prickle	1
69909	30 mBar, thread G 1/4L	1



## GIPSZELŐ EDÉNY

R.sz.	leírás	
37121	Konikus	1



## GIPSZELŐ EDÉNY

R.sz.	leírás	
37122	Alacsony	1



## GIPSZELŐ EDÉNY



R.sz.	leírás	
33275	Alacsony	20



## HORGANYZOTT VÖDÖR

Zn

R.sz.	leírás	
39000	5 l	40
39001	10 l	30
39002	12 l	20
39003	15 l	20



## KÖMŰVES VÖDÖR



R.sz.	leírás	
39005	5 l	1
39010	10 l	1
39012	12 l	1
39014	15 l Öntővel	1
39020	20 l	1
39021	20 l Öntővel	1



## DÉZSA



R.sz.	leírás	
39192	30 l	20
39193	45 l	20



## HABARCSDÉZSA



R.sz.	leírás	
39045	45 l Ø 54 x 27 cm	1
39065	60 l Ø 60 x 35 cm	1
39090	90 l Ø 66 x 35 cm	1



## HABARCSLÁDA



R.sz.	leírás	
39145	45 l 71 x 40 x 21 cm	1
39165	65 l 71 x 40 x 30 cm	1
39190	85 l 77 x 48 x 30 cm	1

## KÖTÉLCSIGA Z 500



R.sz.	leírás	
26780	0,5 t A horoggal	1
26781	0,5 t B szem	1
26782	0,5 t C horoggal és védővel	1
26783	0,5 t D védővel	1





CSOMAGOLÁSI FÓLIA



R.sz.	szélesség	hossz	vastagság		db	
38095	500 mm	600 m	8 µm	átlátszó	1	
38097	100 mm	150 m	20 µm	átlátszó	1	
38096	500 mm	200 m	23 µm	fekete	1	



SITTESZSÁK



R.sz.	szélesség	hossz	vastagság	méret	db	
39194	500 mm	1100 mm	0,16 mm	100	1	10
39196	600 mm	1200 mm	0,16 mm	110	1	10
39198	700 mm	1100 mm	0,16 mm	120	1	10
39200	500 mm	1100 mm	0,20 mm	100	1	10
39202	600 mm	1200 mm	0,20 mm	110	1	10
39204	700 mm	1100 mm	0,20 mm	120	1	10



SITTESZSÁK



R.sz.	szélesség	hossz	vastagság	méret	db	
39195	500 mm	1100 mm	0,16 mm	100	1	10
39197	600 mm	1200 mm	0,16 mm	110	1	10
39199	700 mm	1100 mm	0,16 mm	120	1	10
39201	500 mm	1100 mm	0,20 mm	100	1	10
39203	600 mm	1200 mm	0,20 mm	110	1	10
39205	700 mm	1100 mm	0,20 mm	120	1	10



SZEMETESZSÁK



R.sz.	szélesség	hossz	vastagság	db	
38060	700 mm	1100 mm	0,08 mm	10	1
38063	700 mm	1100 mm	0,10 mm	3	1
38065	700 mm	1100 mm	0,20 mm	3	1



SZEMETESZSÁK



R.sz.	szélesség	hossz	vastagság	db	
38050	500 mm	600 mm	0,04 mm	25	1
38052	600 mm	800 mm	0,04 mm	25	1
38054	700 mm	1100 mm	0,04 mm	25	1



SZEMETESZSÁK



R.sz.	szélesség	hossz	vastagság	db	
38055	1200 mm	1000 mm	0,08 mm	5	

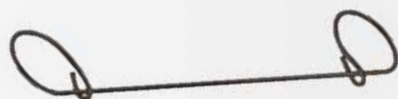

RÖGZÍTŐ HUZAL



R.sz.	leírás	
42365	1,25   100 mm	1
42366	1,25   125 mm	1
42367	1,25   140 mm	1
42368	1,25   160 mm	1



HURKOLÓ

R.sz.	leírás	
50052		12
50050		1



HURKOLÓ

R.sz.	leírás	
50051		2



## KORDON-SZALAG - ERŐVONAL

R.s.	szélesség	hossz	
38955	22 cm	20 m	1
38956	22 cm	50 m	1



## KORDON-SZALAG - VÍZ

R.s.	szélesség	hossz	
38957	22 cm	20 m	1
38958	22 cm	50 m	1



## KORDON-SZALAG - GÁZ

R.s.	szélesség	hossz	
38959	22 cm	20 m	1
38960	22 cm	50 m	1



## KORDON-SZALAG

R.s.	leírás	hossz	
38944	ZÁKAZ VSTUPU, SK	80 mm 250 m	8
38945	VSTUP ZAKÁZÁN, CZ	80 mm 250 m	8



## KORDON-SZALAG

R.s.	hossz	
38948	80 mm 250 m	8



## KORDON-SZALAG

R.s.	hossz	
38946	80 mm 250 m	8



## KORDON-SZALAG

R.s.	hossz	leírás	
38947	48 mm 33 m	jobb	48
38961	48 mm 33 m	balra	48



## JELŐLŐ SZALAG

R.s.	szélesség	hossz	vastagság	
38949	50 mm	50 m	0,15 mm	36

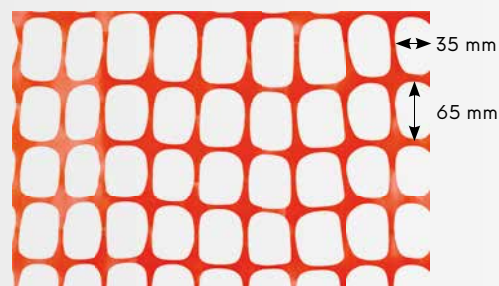

## BIZTONSÁGI KERÍTÉS



R.s.	leírás	
42190	1,2 x 50 m HDPE 140g/m <sup>2</sup>	1



PVC SZALAG KLT.

5x

R.sz.	szélesség	hossz	vastagság	
38931	19 mm	5 m	0,13 mm	100



PVC SZALAG, FEKETE

R.sz.	szélesség	hossz	vastagság	
38932	19 mm	10 m	0,13 mm	10



PVC SZALAG

R.sz.	szélesség	hossz	vastagság	
38925	19 mm	10 m	0,13 mm	10



PVC SZALAG, FEKETE

R.sz.	szélesség	hossz	vastagság	
38968	19 mm	10 m	0,19 mm	10



RAGASZTÓ SZALAG, ÜVEGSZÁL ERŐSÍTÉS

R.sz.	szélesség	hossz	
38927	19 mm	10 m	10



RAGASZTÓ SZALAG, ÜVEGSZÁL ERŐSÍTÉS

R.sz.	szélesség	hossz	
38980	48 mm	10 m	24
38981	48 mm	20 m	24



KÉTOLDALAS RAGASZTÓSZALAG, ÁTLÁTSZÓ

R.sz.	szélesség	hossz	
38924	50 mm	10 m	1
38964	50 mm	25 m	1



KÉTOLDALAS RAGASZTÓSZALAG

PP Polypropylen		R.sz.	szélesség	hossz	
		38929	50 mm	10 m	1
		38966	50 mm	25 m	1



KÉTOLDALAS RAGASZTÓSZALAG

MADE IN EU		R.sz.	szélesség	hossz	
		38990	19 mm	5 m	48
		38991	25 mm	5 m	36



### RAGASZTÓ SZALAG DUCT



R.s.	szélesség	hossz	
38995	48 mm	25 m	24



### ALU-TEXTILSZALAG

R.s.	szélesség	hossz	
38965	30 mm	10 m	1
38928	50 mm	10 m	72
38934	50 mm	45 m	24



### RAGASZTÓ SZALAG DUCT



R.s.	szélesség	hossz	
37275	48 mm	50 m	24



### KITAKARÓSZALAG



R.s.	szélesség	hossz	
37271	38 mm	20 m	24
37270	48 mm	20 m	24
37272	48 mm	50 m	24



### KITAKARÓSZALAG ABLAKHOZ



R.s.	szélesség	hossz	
37273	48 mm	50 m	24



### KITAKARÓSZALAG



R.s.	szélesség	hossz	
37263	38 mm	50 m	24
37264	48 mm	50 m	24



### PVC KÉTOLDALAS RAGASZTÓSZALAG

R.s.	szélesség	hossz	
37266	30 mm	33 m	60
37267	38 mm	33 m	48
37268	50 mm	33 m	36



### KREPP SZALAG



R.s.	szélesség	hossz	
37255	19 mm	50 m	12
37256	25 mm	50 m	12
37257	30 mm	50 m	7
37258	38 mm	50 m	6
37259	50 mm	50 m	6



### PVC SZALAG

R.s.	szélesség	hossz	
38942	50 mm	50 m	72





LEMEZES SZALAG



R.s.	szélesség	hossz	
38972	50 mm	50 m	1
38973	50 mm	100 m	1



ALU ÖNTAPADÓ FÓLIA



R.s.	szélesség	hossz	
38963	48 mm	10 m	1
38943	48 mm	45 m	24



CSÚSZÁSGÁTLÓSZALAG

R.s.	szélesség	hossz	vastagság	
37280	25 mm	15 m	0,8 mm	72
37281	50 mm	15m	0,8 mm	36



RAGASZTÓSZALAG

R.s.	szélesség	hossz	
38930	19 mm	5 m	100



ÜVEGSZÁLAS RÁCSOS-SZALAG, ÖNTAPADÓS

R.s.	szélesség	hossz	
38935	50 mm	20 m	60
38937	50 mm	45 m	36
38939	50 mm	90 m	24
38940	50 mm	153 m	24



ÜVEGSZÁLAS SZALAG

R.s.	szélesség	hossz	
38941	50 mm	25 m	40



TEFLON SZALAG

R.s.	szélesség	hossz	vastagság	
38969	19 mm	15 m	0,2 mm	10



TEFLON SZALAG

R.s.	szélesség	hossz	vastagság	
38933	12 mm	10 m	0,075 mm	10



TEFLON SZALAG

víz- és gázberendezésekhez

R.s.	szélesség	hossz	
38926	2 mm	150 m	20



CSOMAGRAGASZTÓ GÉP

R.s.	
38985	1



TÉPŐZÁRAS SZALAG

R.s.	leírás	
45471	12 mm x 5 m	1



TÉPŐZÁR SZALAG 3 DB

R.s.	szélesség	hossz	
37295	20 mm	150 mm	1
37296	20 mm	200 mm	1
37297	20 mm	250 mm	1

NEW



- 3 pozíció
- visszapattanó kapcsoló



- 360°-ban forgatható fej

- ütészálló fogantyú  
nylon + üvegszál



- dóziszváltás  
9:1 / 18:1



FESTA

KINYOMÓPISZTOLY  
LÉPTETŐS

R.sz. leírás

38027



1

NEW



bekapcsolva

ki

- visszapattanó kapcsoló

FESTA

KINYOMÓPISZTOLY  
LÉPTETŐS

R.sz. leírás

38028



1



**FESTA**

PROFI KINYOMÓPISZTOLY

R.s. leírás  
38013**FESTA**

PROFI KINYOMÓPISZTOLY

R.s. leírás  
38001**FESTA**

PROFI KINYOMÓPISZTOLY

R.s. leírás  
38012**FESTA**

PROFI KINYOMÓPISZTOLY

R.s. leírás  
38024

KINYOMÓPISZTOLY LÉPTETŐS

R.s. leírás  
38010 6 square

KINYOMÓPISZTOLY

R.s. leírás  
38025**FESTA**

KINYOMÓPISZTOLY LÉPTETŐS, 400 ML

R.s. leírás  
38020

KINYOMÓPISZTOLY - LÉPTETŐS

R.s. leírás  
38006



### KINYOMÓPISZTOLY LÉPTETŐS

R.s.	leírás	
38002	6 square	24



### KINYOMÓPISZTOLY - MŰANYAGBÓL

R.s.	leírás	
38003	6 square	24



### KINYOMÓPISZTOLY - KRÓMOZOTT

R.s.	leírás	
38007		24



### KINYOMÓPISZTOLY FÉLIG ZÁRT

R.s.	leírás	
38008		24



### KINYOMÓPISZTOLY - FÉLIG ZÁRT

R.s.	leírás	
38009		24

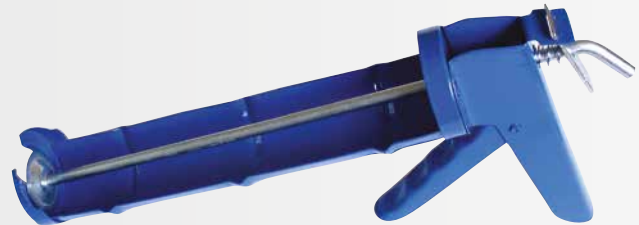

### KINYOMÓPISZTOLY - FÉLIG ZÁRT

R.s.	leírás	
38000		24



**FESTA**

### KINYOMÓPISZTOLY ALU, TÖLTHETŐ

ALU

R.s.	leírás	
38005	310 ml	20
38014	tip 3 db	100



**FESTA**

### KINYOMÓPISZTOLY ALU, TÖLTHETŐ

ALU

R.s.	leírás	
38004	600 ml	12
38014	tip 3 db	100



**FESTA**

PURHAB KINYOMÓ PISZTOLY

TEFLON

R.s. leírás

38018



20



**FESTA**

PURHAB KINYOMÓ TEFLONOS

TEFLON

R.s. leírás

38017



20



TEFLON

**FESTA**

PURHAB KINYOMÓ PISZTOLY

TEFLON

R.s. leírás

38016



20



TEFLON

**FESTA**

PURHABKINYOMÓ PISZTOLY

TEFLON

R.s. leírás

38015



20



PURHAB KINYOMÓ

R.s. leírás

38031



20



**FESTA**

PURHAB KINYOMÓ

R.s. leírás

38022 ABS



20



PURHAB KINYOMÓ

R.s. leírás

38021



24



## PURHAB PISZTOLY TARTALÉK FÚVÓKA

· pisztoly 38015, 38016, 38017, 38018

TEFLON

R.s. leírás

38030

5



## FUGÁZÓ PISZTOLY

· objem 1,5 l



R.s. leírás

38026 5x tip

25



## FUGA KINYOMÓ TASAK



R.s. leírás

38042 3x tip

6



## FESTA HŐLÉGFÚVÓ

feszültség	230V   50Hz
energiafelhasználás	2000W
kapcsoló pozíciója	0 - I (350°C) - II (600°C)
kiegészítők	rozsdamentes 4 db



R.s. leírás  
35320 2000 W



1



## FESTA HŐLÉGFÚVÓ, SZABÁLYOZHATÓ

· digitális kijelző

feszültség	230V   50Hz
energiafelhasználás	2000W
kapcsoló pozíciója	0 - I (50°C) - II (50 - 600°C)
levegőáramlás	250 - 500 l/min.
kiegészítők	rozsdamentes 4 db



R.s. leírás  
35322 2000 W



1



RAGASZTÓ PISZTOLY

**FESTA**

RAGASZTÓ PISZTOLY

· Ø ragasztó 11,2 mm



R.s.	leírás
89975	80 W   230 V



20



RAGASZTÓ PISZTOLY

· Ø ragasztó 7,2 mm



R.s.	leírás
89970	15 W   230 V



25



RAGASZTÓ PISZTOLY

· Ø ragasztó 11,2 mm



R.s.	leírás
89973	60 W   230 V



20



OLVASZTÓ PÁLCIKA, ÁTLÁTSZÓ

R.s.	Ø	hossz	db	csomagolás
89980	7,2 mm	100 mm	12 db	100
89988	7,2 mm	100 mm	1 kg	25



OLVASZTÓ PÁLCIKA, ÁTLÁTSZÓ

R.s.	Ø	hossz	db	csomagolás
89985	11,2 mm	200 mm	10 db	50
89987	11,2 mm	200 mm	1 kg	25



OLVASZTÓ PÁLCIKA

R.s.	Ø	hossz	db	csomagolás
89989	7,2 mm	100 mm	12 db	100
89990	11,2 mm	200 mm	10 db	50



## KEFÉK ÉS HENGEREK



### ECSET

R.sz.	szélesség	vastagság	hossz	
52212	20 mm	15 mm	40 mm	12
52213	30 mm	15 mm	45 mm	12
52214	40 mm	15 mm	45 mm	12
52215	50 mm	15 mm	50 mm	12
52216	60 mm	15 mm	60 mm	12
52217	70 mm	15 mm	65 mm	12
52218	80 mm	15 mm	65 mm	12
52220	100 mm	15 mm	70 mm	12



### ECSET

R.sz.	szélesség	vastagság	hossz	
52202	20 mm	12,5 mm	38 mm	12
52203	30 mm	13 mm	38 mm	12
52204	40 mm	14 mm	44 mm	12
52205	50 mm	16 mm	44 mm	12
52206	60 mm	17 mm	52 mm	12
52208	80 mm	17 mm	52 mm	12
52207	100 mm	18 mm	52 mm	12



### SAROK ECSET

R.sz.	szélesség	vastagság	hossz	
52283	25 mm	10 mm	44 mm	12
52284	38 mm	10 mm	44 mm	12
52285	50 mm	10 mm	44 mm	12
52286	62 mm	10 mm	50 mm	12
52288	76 mm	10 mm	50 mm	12



### ECSET KLT

R.sz.	leírás	
52070	20, 30, 50 mm	50

3x



ECSET KLT

5x

R.sz.	leírás
52071	15 mm, 25 mm, 40 mm, 60 mm, 80 mm



50



FESTÉK ÉS LAKK KAPARÓ

R.sz.
37005

12



KÖRKEFE



R.sz.	leírás
52075	Ø 90 mm

10



TAPÉTÁZÓ KEFE



R.sz.	szélesség	hossz
52076	170 mm	80 mm

10



KÖRKEFE

R.sz.	leírás	hossz
52077	Ø 105 mm	70 mm

12



KEFE

R.sz.	szélesség	hossz
52078	170 mm	70 mm

12

FESTŐHENGEREK KIVÁLASZTÁSA		FESTÉKEK VAGY LAKKOK												
ANYAG	SZÁL HOSSZ.	DISZPERZIÓS	ROZSDAGÁTLÓ	GYANTÁS	OLAJFESTÉK	VÍZES BÁZISÚ	POLIÉSZTER	KÖTŐANYAG	LAZUR	LATEX	EPOXY	KÉT-KOMPONENSŰ	SÚRÚ ANYAGOK	AKRIL
PES	20	•						•		•			•	
PES	20	•	•			•		•		•				•
PAC	18	•						•		•				
PAC	12, 13	•								•				
PAD	18, 21	•								•				
PAD	13	•	•							•				
BÁRÁNY	23	•								•				
NYLON	13		•	•	•	•	•			•	•	•		
VELOUR	4		•	•			•				•	•	•	
MICROFIBRE	10					•			•	•				
MOLITAN				•		•								•



### FESTŐHENGER SZETT

<b>PAC</b> MADE IN EU						
R.s.						
<b>52600</b>	polster 4	180 mm	Ø 8 mm	Ø 53 mm	18 mm	1

### FESTŐHENGER SZETT

<b>PES</b> MADE IN EU					
R.s.					
<b>52610</b>	180 mm	Ø 6 mm	Ø 42 mm	20 mm	25
<b>52605</b>	250 mm	Ø 6 mm	Ø 42 mm	20 mm	20



### FESTŐHENGER SZETT

- 1x festőhenger PAD 13mm/10cm
- 1x festőhenger PAC 12mm/10cm
- 1x festőhenger PES 11cm
- markolat +tál

<b>MADE IN EU</b>		
R.s.		
<b>52602</b>		10



### SAROK FESTÉKHENGER

<b>PAC</b> MADE IN EU				
R.s.				
<b>52601</b>	fogantyúval	Ø 6 mm	18 mm	1





POLYACRYL FESTŐHENGER

**PAC**  
MADE IN EU

R.s.						
52331	100 mm	Ø 6 mm	Ø 17 mm	12 mm	50	
52334	250 mm	Ø 8 mm	Ø 48 mm	12 mm	10	



POLYACRYL FESTŐHENGER

**PAC**  
MADE IN EU

R.s.						
52391	polster 5	250 mm	Ø 8 mm	Ø 54 mm	18 mm	10



POLYACRYL FESTŐHENGER

**PAC**  
MADE IN EU

R.s.						
52328	polster 5	250 mm	Ø 8 mm	Ø 54 mm	18 mm	10
52456	polster 7	250 mm	Ø 8 mm	Ø 67 mm	18 mm	10



POLYAMID FESTŐHENGER

**PAD**  
MADE IN EU

R.s.						
52428	polster 7	250 mm	Ø 8 mm	Ø 67 mm	18 mm	10



POLYESTER FESTŐHENGER

**PES**  
MADE IN EU

R.s.						
52315	polster 5	180 mm	Ø 8 mm	Ø 54 mm	20 mm	10



LAKKOZÓ FESTÉKHENGER,

**PAD**  
MADE IN EU

R.s.						
52421		100 mm	Ø 6 mm	Ø 17 mm	13 mm	50
52424		250 mm	Ø 8 mm	Ø 48 mm	13 mm	10



POLYESTER FESTŐHENGER

**PES**  
MADE IN EU

R.s.						
52305		180 mm	Ø 6 mm	Ø 42 mm	20 mm	10
52306		250 mm	Ø 6 mm	Ø 42 mm	20 mm	10



LAKKOZÓ FESTÉKHENGER

**MADE IN EU**

R.s.						
52471	rovny	100 mm	Ø 6 mm	Ø 35 mm	50	

NEW

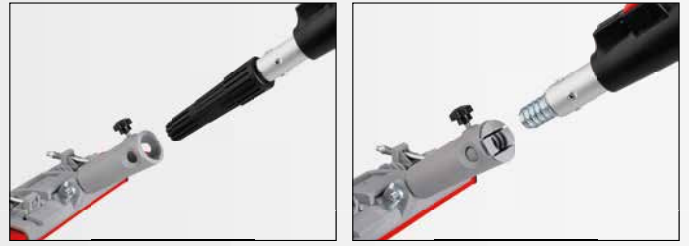

FESTA®

## TELESZKÓPOS RÚD

csavar 31610, 34203

R.sz.	Leírás	
52011	88 - 140 cm	1



## TELESZKÓPOS RÚD

ALU

R.sz.	hossz		
52010	120 cm	ALU	50
52012	240 cm	ALU	25



## TELESZKÓPOS RÚD

R.sz.	hossz		
52020	300 cm	fém	10



## TELESZKÓPOS RÚD

R.sz.	hossz		
52030	240 cm	fiberglass	6



ITAL  
MADE IN  
EU

R.sz.	leírás	
52662	150 x 270 mm 100 mm	1
52666	260 x 290 mm 180 mm	1
52671	330 x 340 mm 250 mm	1

## FESTŐ VÖDÖR

MADE IN EU

R.sz.	objem	
52694	8 l	25
52695	12 l	20



RÁCS  
MADE IN EU

R.s.	szélesség	vízka	
52652	230 mm	250 mm	100
52656	270 mm	290 mm	100



FESTŐHENGER NYÉL  
MADE IN EU

R.s.	leírás	
52640	5 cm   Ø 6 mm	100
52645	8,5 cm   Ø 6 mm x 27 mm	100



FESTŐHENGER NYÉL  
MADE IN EU

R.s.	leírás	
52630	18 cm   Ø 6 mm	100
52635	25 cm   Ø 6 mm	100
52620	18 cm   Ø 8 mm	50
52625	25 cm   Ø 8 mm	50



TAKARÓFÓLIA TEKERCSEBEN

R.s.	szélesség	hossz	
37243	55 cm	30 m	60
37244	110 cm	30 m	30
37245	140 cm	30 m	30
37246	180 cm	15 m	30
37290	210 cm	20 m	30
37247	240 cm	15 m	30
37291	270 cm	16 m	30



FESTŐOVERÁL

R.s.	leírás	
50585	méret M	1
50586	méret L	1
50587	méret XL	1
50588	méret XXL	1



PORVÉDŐ AJTÓHOZ  
CIPZÁRRAL

R.s.	leírás	
37248	1,2 x 2,2 m tape 100 µm 45 mm x 25 m	25



UNIVERZÁLIS TAKARÓFÓLIA

R.s.	objem	vastagság	
37250	4 x 5 m	0,007 mm	100
37251	4 x 12,5 m	0,007 mm	50
37252	2 x 50 m	0,007 role	20



UNIVERZÁLIS TAKARÓFÓLIA

R.s.	leírás	vastagság	
37253	4 x 5 m	0,03 mm	100



HULLÁMPAPÍR

R.s.	szélesség	hossz	
54008	1 m	10 m	1



**EKONOMIK** \*\*  
**STANDARD** \*\*\*  
**PROFI** \*\*\*\*



- kétszeres forrasztású szegély polypropylén zsinórral
- ezüst réteg a napsugarak jobb visszaverődésére
- ALU szemek 1 méterenkint



## LETAKARÓ PONYVA

· kék



R.s.	leírás	
25369	2 x 2 m	50
25370	2 x 3 m	20
25371	3 x 4 m	10
25372	3 x 5 m	10
25373	4 x 5 m	10

R.s.	leírás	
25374	4 x 6 m	5
25376	5 x 8 m	5
25378	6 x 10 m	2
25379	8 x 12 m	2
25380	10 x 15 m	2

## LETAKARÓ PONYVA STANDARD

· kék-ezüst



**70 g/m<sup>2</sup>**

R.s.	leírás		R.s.	leírás	
25155	2 x 2 m	50	25025	5 x 5 m	10
25006	2 x 3 m	50	25030	5 x 6 m	10
25009	3 x 3 m	35	25040	5 x 8 m	5
25012	3 x 4 m	20	25048	6 x 8 m	5
25015	3 x 5 m	10	25060	6 x 10 m	5
25016	4 x 4 m	10	25096	8 x 12 m	2
25020	4 x 5 m	10	25150	10 x 15 m	2
25024	4 x 6 m	10	25153	15 x 20 m	1



## LETAKARÓ PONYVA STANDARD

· zöld



**70 g/m<sup>2</sup>**

R.s.	leírás	
25179	2 x 2 m	50
25180	2 x 3 m	50
25195	2 x 8 m	20
25181	3 x 4 m	20
25182	3 x 5 m	10
25183	4 x 5 m	10

R.s.	leírás	
25184	4 x 6 m	10
25186	5 x 8 m	5
25188	6 x 10 m	5
25189	8 x 12 m	2
25190	10 x 15 m	2

## LETAKARÓ PONYVA PROFI

· kék-ezüst



**140 g/m<sup>2</sup>**

R.s.	leírás	
25206	2 x 3 m	25
25212	3 x 4 m	10
25215	3 x 5 m	8
25220	4 x 5 m	8
25224	4 x 6 m	8
25230	5 x 6 m	8

R.s.	leírás	
25240	5 x 8 m	4
25248	6 x 8 m	3
25260	6 x 10 m	3
25296	8 x 12 m	2
25350	10 x 15 m	1



LETAKARÓ PONYVA PROFI

· zöld-zöld

200 g/m<sup>2</sup>

R.sz.	leírás		R.sz.	leírás	
25160	2 x 3 m	15	25164	4 x 6 m	3
25171	2 x 8 m	1	25167	6 x 8 m	2
25162	3 x 5 m	5	25169	8 x 12 m	1
25163	4 x 5 m	4	25170	10 x 15 m	1

LETAKARÓ PONYVA

· kék-ezüst

120 g/m<sup>2</sup>

R.sz.	leírás		R.sz.	leírás	
25003	Ø 3,6 m	15	25004	Ø 4,5 m	5
25005	Ø 5,5 m	4	25002	Ø 6,5 m	3



PONYVAFESZÍTŐ

4x

R.sz.	leírás	
25400	20 cm	1



PONYVA RINGLIZÓ

R.sz.	leírás	
25410	aplikátor ok + 25 szem	1



PONYVA RINGLI

10x

R.sz.	leírás	
25001		1

RÖGZÍTŐ HOROGOK  
LÁNCOK  
ÉS DRÓTKÖTELEK

## FESZITŐ CSAVAR

DIN 1480 Zn

R.s.	leírás	
50100	5 x 70 mm	10
50101	6 x 90 mm	10
50102	8 x 125 mm	10
50103	10 x 150 mm	10

R.s.	leírás	
50104	12 x 200 mm	10
50106	16 x 230 mm	10
50108	20 x 220 mm	10



## ALUMÍNÍUM KARABÍNER

DIN 5299 C Zn

R.s.	leírás	
51204	4 mm	10
51205	5 mm	10
51206	6 mm	10
51207	7 mm	10
51208	8 mm	10

R.s.	leírás	
51209	9 mm	10
51210	10 mm	10
51211	11 mm	10
51212	12 mm	10



## MENETES KARABÍNER

Zn

R.s.	leírás	
51241	4 mm	10
51242	5 mm	10
51243	6 mm	10
51244	7 mm	10

R.s.	leírás	
51245	8 mm	10
51246	10 mm	10
51247	12 mm	10



## S KAPOCS

Zn

R.s.	leírás	
51271	3 mm	10
51272	4 mm	10
51273	5 mm	10
51274	6 mm	10

R.s.	leírás	
51275	7 mm	10
51276	8 mm	10
51278	10 mm	10



## SZEMES ANYA

DIN 5820 Zn

R.s.	leírás	
51320	6 mm	10
51321	8 mm	10
51322	10 mm	10
51323	12 mm	10

R.s.	leírás	
51324	14 mm	10
51325	16 mm	10
51327	20 mm	10



## SZEMES CSAVAR

DIN 5820 Zn

R.s.	leírás	
51300	6 mm	10
51301	8 mm	10
51302	10 mm	10
51303	12 mm	10
51304	14 mm	10

R.s.	leírás	
51305	16 mm	10
51306	18 mm	10
51307	20 mm	10
51308	22 mm	10

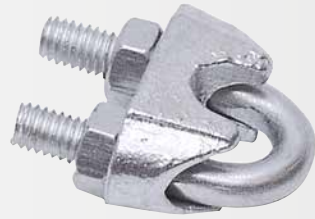

KÖTÉL BILINCS

Zn

R.s.	leírás	
51280	3 mm	10
51281	5 mm	10
51282	6 mm	10
51283	8 mm	10

R.s.	leírás	
51284	10 mm	10
51286	12 mm	10
51287	14 mm	10
51288	16 mm	10



ALUMÍNIUM KARABÍNER

Zn

R.s.	leírás	
51220	53 mm	10
51221	67 mm	10
51222	76 mm	10



FORGÓ SZEM

Zn

R.s.	leírás	
51225	3,8 mm	10
51226	4,5 mm	10
51227	6,0 mm	10



RÖVID SZEMŰ LÁNC

DIN 5685 A Zn

R.s.	szem mérete	hossz	
51402	2 x 10 mm	110 m	1
51403	3 x 16 mm	60 m	1
51404	4 x 21 mm	40 m	1
51405	5 x 23 mm	30 m	1

R.s.	szem mérete	hossz	
51406	6 x 24 mm	18 m	1
51407	7 x 50 mm	16 m	1
51408	8 x 32 mm	10 m	1
51410	10 x 39 mm	10 m	1

LÁNC VICTOR

DIN 5686 Zn

R.s.	Ø	hossz		R.s.	Ø	hossz	
51430	1,4 mm	150 m	1	51433	2,0 mm	118 m	1
51431	1,6 mm	150 m	1	51435	2,5 mm	70 m	1
51432	1,8 mm	150 m	1	51436	2,8 mm	50 m	1



HOSSZÚ SZEMŰ LÁNC

DIN 5685 C Zn

R.s.	szem mérete	hossz	
51412	2 x 12 mm	80 m	1
51413	3 x 26 mm	60 m	1
51414	4 x 32 mm	38 m	1
51415	5 x 35 mm	32 m	1

R.s.	szem mérete	hossz	
51416	6 x 43 mm	18 m	1
51417	7 x 50 mm	16 m	1
51418	8 x 54 mm	10 m	1
51420	10 x 65 mm	10 m	1

LÁNC MŰANYAG



R.s.	leírás	
51450	6 mm 25 m piros fehér	1



## DRÓTKÖTÉL ÖSSZEKÖTŐ

**DIN 5685 C Zn**

R.s.	leírás	
51348	Ø 10 mm	10



## DRÓTKÖTÉL ÖSSZEKÖTŐ

**DIN 5685 C Zn**

R.s.	leírás	
51338	Ø 5 mm	10
51341	Ø 10 mm	10



## KÖTÉL SZEM

**Zn**

R.s.	leírás	
51257	Ø 14 mm	10
51258	Ø 16 mm	10
51259	Ø 18 mm	10
51260	Ø 20 mm	10
51261	Ø 22 mm	10
51262	Ø 24 mm	10
51263	Ø 26 mm	10
51264	Ø 28 mm	10
51265	Ø 30 mm	10



## CSÖRLŐ (KÖTÉLLEL ÉS KAMPÓVAL)

**Zn**

R.s.	noszt	hossz lana	
26720	300 kg	8 m	1
26705	450 kg	8 m	1
26721	500 kg	8 m	1
26722	800 kg	8 m	1
26706	900 kg	8 m	1
26707	1350 kg	8 m	1

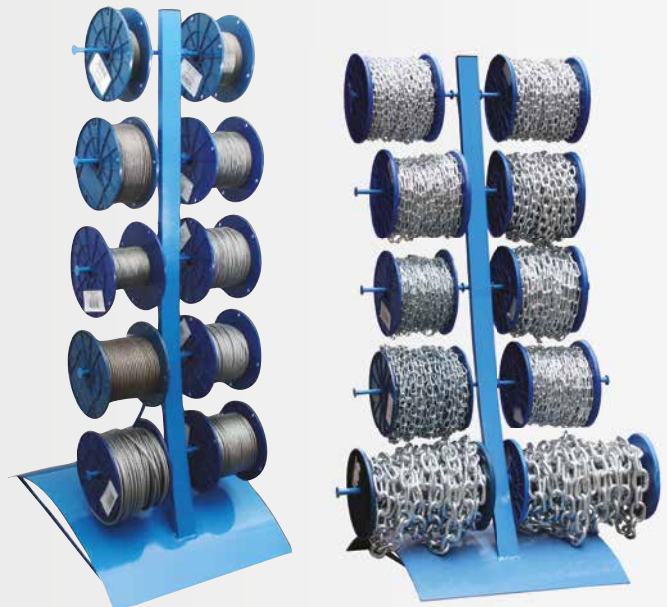

## BEMUTATÓ ÁLLVÁNY

R.s.	leírás	
51196	Állvány láncok töltött	10
51197	Állvány kötelekkel töltött	10
51198	Promóciós állvány láncokhoz	10
51199	Promóciós állvány kötélehez	10



## ACÉL HUZAL ZN

**Zn**

R.s.	průměr lana	hossz	
51100	Ø 1 mm	500 m	1
51101	Ø 1,2 mm	500 m	1
51102	Ø 1,5 mm	500 m	1
51103	Ø 2 mm	200 m	1
51104	Ø 3 mm	200 m	1
51105	Ø 4 mm	100 m	1
51106	Ø 5 mm	75 m	1
51107	Ø 6 mm	75 m	1
51130	Ø 8 mm	75 m	1
51131	Ø 10 mm	50 m	1
51132	Ø 12 mm	50 m	1



## ACÉL HUZAL PVC

**Zn**

R.s.	průměr lana	hossz	
51108	Ø 2/3 mm	200 m	1
51109	Ø 3/4 mm	100 m	1
51110	Ø 4/5 mm	75 m	1
51111	Ø 5/6 mm	50 m	1



## ROZSDAMENTES ACÉL HUZAL

**INOX**

R.s.	průměr lana	hossz	
51120	Ø 1 mm	300 m	1
51121	Ø 1,2 mm	300 m	1
51122	Ø 1,5 mm	300 m	1
51123	Ø 2 mm	200 m	1
51124	Ø 3 mm	200 m	1
51125	Ø 4 mm	100 m	1
51126	Ø 5 mm	75 m	1
51127	Ø 6 mm	75 m	1





**FESTA**

LED LÁMPA



R.s.	leírás
37611	1

HALOGÉN LÁMPA



R.s.	leírás	1
37600	120 W	1
37601	400 W	1

HALOGÉN IZZÓ

R.s.	leírás	1
37604	120 W	1
37606	250 W	1
37605	400 W	1



**FESTA**

LED LÁMPA

· max. magasság 180 cm

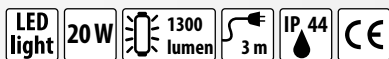

R.s.	leírás
37615	20 W
37616	2 x 20 W

HALOGÉN LÁMPA

· max. magasság 180 cm

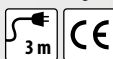

R.s.	leírás
37602	400 W
37603	2 x 400 W



## TELESZKÓPOS ÖSSZECSUKHATÓ LÉTRA

· max. terhelés 150 kg



R.sz.	leírás	
48415	1,9 / 3,8 m	6/12 partíció



## ÖSSZECSUKHATÓ MUNKAÁLLVÁNY

· max. terhelés 150 kg



R.sz.	leírás	
48420		1

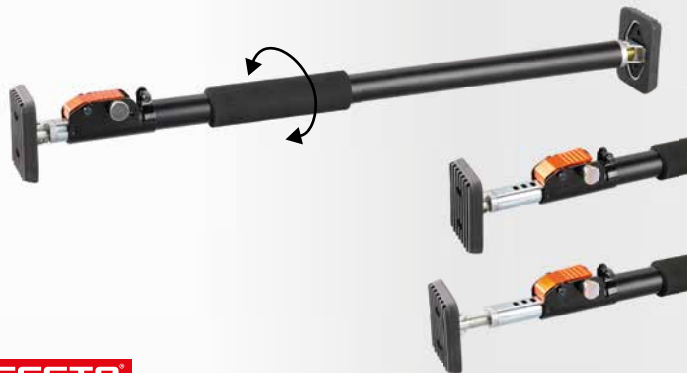

**FESTA**

## ZSALUZAT TÁVTARTÓ, ÁLLÍTHATÓ

· max. terhelés 40 kg

R.sz.	leírás	
52060	66 - 115 cm	1
52065	160 - 290 cm	1



## TELESZKÓPOS LÉTRA

· max. terhelés 150 kg



R.sz.	leírás	
48410	3,2 m	11 partíció
48411	3,8 m	13 partíció



## ZSALUZAT TÁVTARTÓ, ÁLLÍTHATÓ

· 48449 ketrec állítható kellékekhez



R.sz.	leírás	
48452	160 - 290 cm	1
48453	180 - 320 cm	1
48454	200 - 360 cm	1
48455	250 - 440 cm	1
48456	260 - 380 cm	1
48457	220 - 400 cm	1



## ZSALUZAT TÁVTARTÓ, ÁLLÍTHATÓ

R.sz.	leírás	
52050	50 - 115 cm	1
52055	115 - 290 cm	1



FACSAVAR

db	
60	3,0 x 12 mm
50	3,0 x 16 mm
40	3,0 x 20 mm
50	3,5 x 20 mm
40	3,5 x 30 mm
25	4,0 x 30 mm
20	4,0 x 40 mm
15	5,0 x 50 mm
10	5,0 x 60 mm

310x

R.s. leírás  
55642



1

FACSAVAR + TIPLI

csavar fa		dűbel	
db		db	
40	3,5 x 30 mm	40	5 x 25 mm
25	4,0 x 40 mm	25	6 x 30 mm
12	5,0 x 50 mm	12	8 x 40 mm
8	6,0 x 60 mm	8	10 x 50 mm

170x

R.s. leírás  
55645



1

FACSAVAR

db	
350	3,0 x 16 mm
280	3,0 x 20 mm
220	3,0 x 25 mm
250	3,5 x 20 mm
240	3,5 x 25 mm
180	3,5 x 3, mm
280	4,0 x 16 mm
80	4,0 x 30 mm
40	4,0 x 40 mm
30	4,0 x 50 mm
25	5,0 x 50 mm
25	5,0 x 60 mm

2000x

R.s. leírás  
55640 2000 db



1



KÉMÉNYAJTÓ, FÉM



R.s. leírás  
65062



1



KÉMÉNYAJTÓ, FÉM



R.s. leírás  
65063 szürke  
65064 fehér



1



KÉMÉNYAJTÓ, FÉM



R.s. leírás  
65065



1



332

WINLAND METSZŐOLLÓ



338

METSZŐOLLÓ



339

KERTI SZERSZÁMOK



340

BOZÓTVÁGÓ KÉS



341

KERTÉSZETI ESZKÖZÖK



343

FÚNYÍRÓ DAMIL



344

FENŐKŐ



345

NÖVÉNYFUTTATÓ  
DRÓTBÓL

346

FÁTYOLFÓLIA



348

LOCSOLÓPISZTOLY



360

TÖMLŐTARTÓ KOCSI,  
MUANYAG

362

TÖMLŐ ÖSSZEKÖTŐ



364

ÖNTÖZOKANNA



365

KÉZI PERMETEZO



367

GEREBLYE



372

ÁSÓ ÉS LAPÁT



378

KAPA HEGYES, CSÁKÁNY



381

BETONSEPRŰ

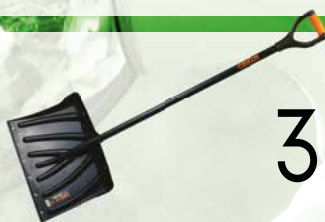

384

HÓLAPÁT



386

NYÉL



387

SZÚNYOGHÁLÓ

## KERTI SZERSZÁMOK ÉS KERÍTÉS 330 - 397

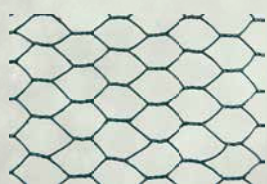

389

DRÓTHÁLÓ



392

OSZLOPTALP



394

ÁRNYÉKOLÓTEXTIL



395

GRILLESZKÖZ



## METSZŐOLLÓ

- forrészionális kerti vágók
- kiváló minőségű anyagok
- Minőségi gyártás
- ergonomikus markolat



### METSZŐOLLÓ

· penge HCS SK - 5, Japán acél

**SK5**



R.sz.	leírás	
45020	205 mm	10
44980	Tartalék rugó	1



### METSZŐOLLÓ

· penge HCS SK - 5, Japán acél

**SK5**



R.sz.	leírás	
45023	205 mm	10
44980	Tartalék rugó	1



### METSZŐOLLÓ

· penge HCS SK - 5, Japán acél

**SK5**



R.sz.	leírás	
45063	215 mm	10
44981	Tartalék rugó	1



### METSZŐOLLÓ

· penge HCS SK - 5, Japán acél

**SK5**

**TEFLON**



R.sz.	leírás	
44972	215 mm	10
44981	Tartalék rugó	1



METSZŐOLLÓ

SK5

R.sz.	leírás	
45099	190 mm	10
44983	Tartalék rugó	1



METSZŐOLLÓ

SK5

R.sz.	leírás	
45098	220 mm	10
44983	Tartalék rugó	1



METSZŐOLLÓ

SK5

TEFLON

R.sz.	leírás	
45095	200 mm	10
44982	Tartalék rugó	1

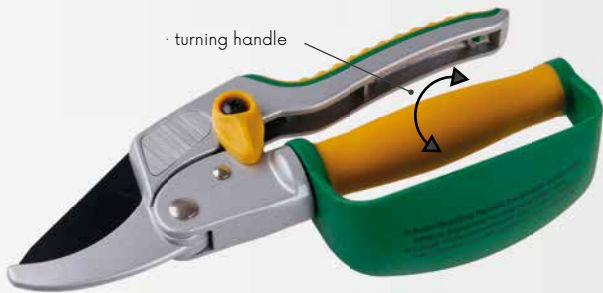

METSZŐOLLÓ

· penge HCS SK - 5, Japán acél

SK5

TEFLON

R.sz.	leírás	
45096	220 mm	6
44982	Tartalék rugó	1



METSZŐOLLÓ

· penge HCS SK - 5, Japán acél

SK5

TEFLON

R.sz.	leírás	
45097	250 mm	10
44981	Tartalék rugó	1



METSZŐOLLÓ

INOX

R.sz.	leírás	
45089	160 mm	10



METSZŐOLLÓ

INOX

R.sz.	leírás	
45088	160 mm	10



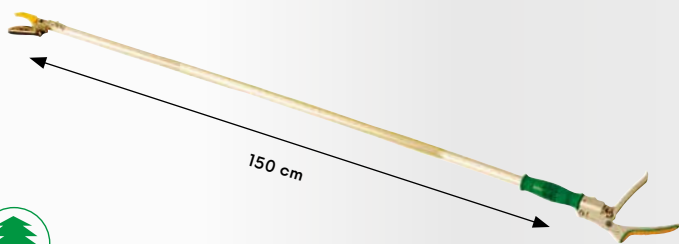

## TELESZKOPÓS ÁGVÁGÓ

R.sz. leírás

45017



10



## PENGÉK

· mert 45095, 45027

SK5 TEFLON

R.sz. leírás

45094



20



## ÁGVÁGÓ OLLÓ

· penge HCS SK - 5, Japán acél

max. 45mm SK5 TEFLON

R.sz. leírás

44991 76 cm



12



## ÁGVÁGÓ OLLÓ

· penge HCS SK - 5, Japán acél

max. 45mm SK5 TEFLON

R.sz. leírás

44992 70 - 103 cm



10



## TARTALÉK RUGÓ

R.sz.	noyice	
44981	45021, 45025, 45063, 45097	1
44980	45020, 45023	1
44983	45098, 45099	1
44982	45027, 45095, 45096	1
44984	45110, 45014, 45026	1
44985	45018	1
44986	45019, 45029, 44970	1
44987	45021	1
44988	44971	1
44989	45015, 45016	1

## ÁGVÁGÓ OLLÓ



## SÖVÉNYVÁGÓ OLLÓ

TEFLON

R.sz. leírás

44996 61 cm, hullámél



12





ÁGVÁGÓ OLLÓ



R.sz.	leírás	
44997	61 cm, rovné ostří	12



FÚNYÍRÓ OLLÓ, 360° FORGATHATÓ MARKOLAT



R.sz.	leírás	
44998		6



OLLÓ ÉLEZŐ GYÉMÁNTOS 6VI



R.sz.	leírás	
45068		10



OLLÓ ÉLEZŐ GYÉMÁNTOS



R.sz.	leírás	
45048		20

METSZŐOLLÓ



R.sz.	leírás	
45010	190 mm	12
44984	Tartalék rugó	1

METSZŐOLLÓ



R.sz.	leírás	
45014	190 mm	12
44984	Tartalék rugó	1

METSZŐOLLÓ



R.sz.	leírás	
45026	150 mm	12
44985	Tartalék rugó	1

METSZŐOLLÓ KOVÁCSOLT



R.sz.	leírás	
45018	210 mm kované	10



METSZŐOLLÓ

SK5 TEFLON



R.s. leírás  
45019 210 mm

10



FESTA  
METSZŐOLLÓ

nylon fogantyú

SK5 TEFLON NYLON



R.s. leírás  
45021 200 mm

6



METSZŐOLLÓ

ALU



R.s. leírás  
45025 200 mm

12



METSZŐOLLÓ

INOX



R.s. leírás  
44970 210 mm

10



METSZŐOLLÓ

TEFLON



R.s. leírás  
45027 200 mm

10



METSZŐOLLÓ

INOX ALU



R.s. leírás  
45029 200 mm

24



METSZŐOLLÓ

INOX



R.s. leírás  
44971 160 mm

10



METSZŐOLLÓ



R.s. leírás  
45016 180 mm

12



SZÜRETELŐ OLLÓ, EGYENES



R.s. leírás  
45015 190 mm, egyenes

12



METSZŐOLLÓ TOK

R.s. leírás  
37317

1



FÚNYÍRÓ OLLÓ



R.s. leírás  
45011 300 mm

1



FÚNYÍRÓ OLLÓ, 180° FORGARHATÓ MARKOLAT



R.s. leírás  
45012 370 mm, turning 180°

1

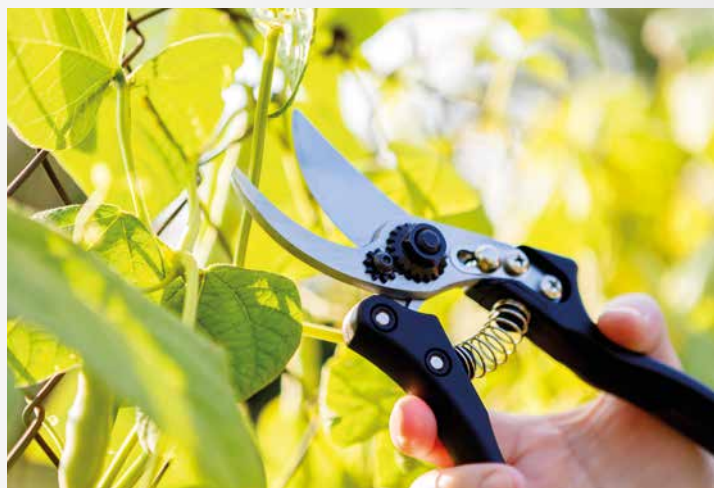

ÁGVÁGÓ OLLÓ

nylon fogantyú



R.s. leírás  
44999 540 mm, kerek

12



**FESTA**

ÁGVÁGÓ OLLÓ



R.s. leírás  
45000 750 mm, kerek

6



**FESTA**

ÁGVÁGÓ OLLÓ



R.s. leírás  
45001 710 mm, kerek

6

**FESTA**

ÁGVÁGÓ OLLÓ

TEFLON

R.sz.	leírás
45002	750 mm, Kadbolókerékkel

12

**FESTA**

ÁGVÁGÓ OLLÓ

TEFLON

R.sz.	leírás
45003	660-900 mm, teleszkópikus

6



SÖVÉNYVÁGÓ OLLÓ

TEFLON



R.sz.	leírás
44995	440   160 mm

12

**FESTA**

SÖVÉNYVÁGÓ OLLÓ

TEFLON

R.sz.	leírás
45005	580   230 mm, hullámél

6



SÖVÉNYVÁGÓ OLLÓ

R.sz.	leírás
45009	500   190 mm, hullámél

6

**FESTA**

SÖVÉNYVÁGÓ OLLÓ

TEFLON

R.sz.	leírás
45006	580   230 mm, egyenes él

6



SÖVÉNYVÁGÓ OLLÓ

R.sz.	leírás
45008	500   190 mm, egyenes él

6

**FESTA**

SÖVÉNYVÁGÓ OLLÓ

TEFLON

R.sz.	leírás
45007	670-870   230 mm, hullámél

6



**FESTA**

BECSUKHATÓ KERTFŰRÉSZ



· 3x élezett, edzett fogazás



R.sz.	leírás
45061	150 mm

12



**FESTA**

BECSUKHATÓ KERTFŰRÉSZ



· 3x élezett, edzett fogazás

R.sz.	leírás
45060	180 mm

6



**FESTA**

KERTIFŰRÉSZ TOKKAL



· 3x élezett, edzett fogazás



R.sz.	leírás
45062	260 mm

24



**FESTA**

ÍVES ÁGVÁGÓ FŰRÉSZ



· 3x élezett, edzett fogazás

R.sz.	leírás
24152	300 mm

12



**FESTA**

TELESZKÓPOS ÁGVÁGÓ FŰRÉSZ



· 3x élezett, edzett fogazás

R.sz.	leírás
45033	230 - 490 cm   340 mm

1



ÁGVÁGÓ FŰRÉSZ

R.sz.	leírás
45030	fűrész 300 mm teleszkópos pólus 240 cm
45031	fűrész 300 mm

6

6



ÁGVÁGÓ OLLÓ

R.sz.	leírás
45032	Fém, fűrész nélkül

10

10



**FESTA**

BOZÓTVÁGÓ KÉS

TEFLON

R.s.	leírás	
45069	440 mm	6



**FESTA**

BOZÓTVÁGÓ KÉS

TEFLON

R.s.	leírás	
44950	490 mm	4



BOZÓTVÁGÓ KÉS

INOX

R.s.	leírás	
45083	430 mm	12
45084	600 mm	6



BOZÓTVÁGÓ KÉS

fogantyú körisből készült

R.s.	leírás	
45081	510 mm	36
45082	710 mm	36



KERTI LAPÁT, SZÉLES

INOX

R.sz.	leírás	
45056	360 mm	12



KERTI LAPÁT, KESKENY

INOX

R.sz.	leírás	
45057	350 mm	12



KERTI KAPA EGYENES

INOX

R.sz.	leírás	
45058	270 mm	12



GYOMLÁLÓ

INOX

R.sz.	leírás	
45059	370 mm	12



KERTI LAPÁT, SZÉLES, MŰANYAG

NYLON

R.sz.	leírás	
45065	280 mm	1



KERTI LAPÁT, KESKENY, MŰANYAG

NYLON

R.sz.	leírás	
45066	310 mm	1



KERTI VILLA MŰANYAG

NYLON

R.sz.	leírás	
45067	290 mm	1



KERTI KÉSZLET

HOBBY

4x

HOBBY

R.sz.	leírás	
45035	240 mm	35



ÜLTETŐ "T"

R.sz.	leírás	
45038	280 mm	60



GYOMLÁLÓ

R.sz.	leírás	
44955	950 mm	16



GYOMLÁLÓ KÉS

R.sz.	leírás	
45079	200 mm	1



GYOMLÁLÓ KÉS

R.sz.	leírás	
45080	200 mm „L”	1



ÖSSZECSUKHATÓ LAPÁT

Eset, carcasă

R.sz.	leírás	
61085	410 mm	6



PALÁNTÁZÓ

INOX

R.sz.	leírás	
45040	230 mm	60



GYÜMÖLCSSZEDŐ



R.sz.	leírás	
45041		75



GYÜMÖLCSSZEDŐ

R.sz.	leírás	
45039		50
45034	170 - 300 cm, nyéllel	5





FÚNYÍRÓ DAMIL



R.sz.	leírás	leírás
45530	■	2 mm x 15 m 1
45531	■	2,4 mm x 15 m 1
45532	■	3 mm x 15 m 1
45533	■	3,15 mm x 15 m 1
45534	■	4 mm x 15 m 1

FÚNYÍRÓ DAMIL



R.sz.	leírás	leírás
45500	●	1,3 mm x 15 m 30
45502	★	1,3 mm x 15 m 30
45503	●	1,6 mm x 15 m 20
45505	★	1,6 mm x 15 m 20
45506	●	2 mm x 15 m 12
45508	★	2 mm x 15 m 12
45517	■	2 mm x 15 m 10
45509	●	2,4 mm x 15 m 12
45511	★	2,4 mm x 15 m 12
45512	■	2,4 mm x 15 m 12
45518	■	2,4 mm x 15 m 10
45523	●	2,7 mm x 15 m 10
45524	★	2,7 mm x 15 m 10
45513	●	3 mm x 15 m 10
45515	■	3 mm x 15 m 10
45516	■	3 mm x 15 m 10
45519	■	3 mm x 15 m 10



FÚNYÍRÓ DAMIL

R.sz.	leírás	leírás
45520	●	2 mm x 162 m 10
45521	●	2,4 mm x 112 m 10
45528	●	2,7 mm x 90 m 10
45522	●	3 mm x 72 m 10
45525	★	2 mm x 162 m 10
45526	★	2,4 mm x 112 m 10
45529	★	2,7 mm x 90 m 10
45527	★	3 mm x 72 m 10



## FENŐKŐ

R.sz.	leírás	
45046	205 x 15 mm	100



## FENŐKŐ

R.sz.	leírás	
45370	250 x 33 x 18 mm	20

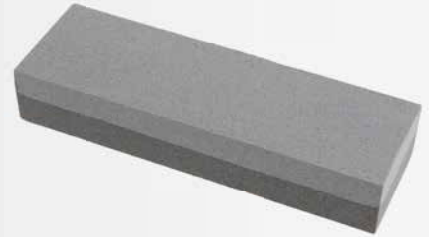

## FENŐKŐ

R.sz.	leírás	
45045	150 x 50 x 30 mm	10



## ÉLEZŐ

R.sz.	leírás	
45068		10



## ÉLEZŐ

R.sz.	leírás	
45048		20



## FENŐKŐ

R.sz.	leírás	
16990	Ø 50 mm	50



## ÉLEZŐ

R.sz.	leírás	
16991		20



## KÖTŐSZALAGOK

R.sz.	leírás	
45472	3 cm x 3 m, 3 db	36



## KÖTŐZŐSZALAG

R.sz.	leírás	
45473	3 cm x 50 m	60



## TÉPŐZÁRAS SZALAG

R.sz.	leírás	
45471	12 mm x 5 m	1



## KÖTŐZŐDRÓT

R.sz.	leírás	
45043	30 m	30

KÖTŐHUZAL  
GUMIZÁSSAL

R.sz.	leírás	
23845	3 mm x 8 m	30
23846	4 mm x 6 m	30
23847	5 mm x 4 m	30



## NÖVÉNYFUTTATÓ ÜVEGSZÁLAS

R.sz.	leírás	
45036	180 cm Ø 7,9 mm	100



## FOGAS RÖGZÍTŐ SZALAG

50x

R.sz.	leírás	
23840		20



## NÖVÉNYFUTTATÓ DRÓTBÓL

R.sz.	leírás	
44041	1,2 m, Ø 5,5 mm komaxit - green	10
44042	1,5 m, Ø 6 mm komaxit - green	10
44043	1,8 m, Ø 6 mm komaxit - green	10
45049	1,8 m, Ø 7 mm komaxit - green	10
45044	1,8 m, Ø 7 mm komaxit - silver	10
44050	2,2 m, Ø 7 mm komaxit - green	10



## CSATLAKOZÓ IDOM, MÜ.A

R.sz.	leírás	
45670	8 mm	10
45671	11 mm	10
45672	16 mm	10
45673	20 mm	10

MOQ  
10



## MŰANYAG BEVONATÚ KERTI RÚD

R.sz.	leírás		R.sz.	leírás		R.sz.	leírás	
45650	90 cm Ø 8 mm	25	45655	150 cm Ø 11 mm	25	45659	180 cm Ø 16 mm	25
45651	120 cm Ø 8 mm	25	45656	180 cm Ø 11 mm	25	45660	210 cm Ø 16 mm	25
45652	150 cm Ø 8 mm	25	45661	210 cm Ø 11 mm	25	45662	150 cm Ø 20 mm	10
45653	90 cm Ø 11 mm	25	45657	120 cm Ø 16 mm	25	45663	180 cm Ø 20 mm	10
45654	120 cm Ø 11 mm	25	45658	150 cm Ø 16 mm	25	45664	210 cm Ø 20 mm	10

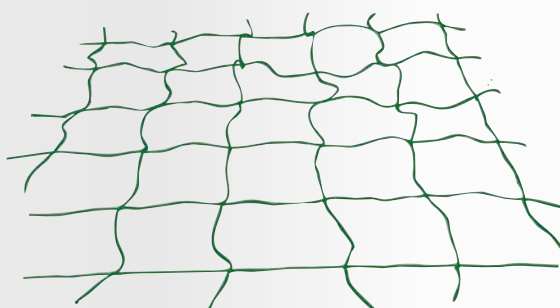

## UBORKAHÁLÓ

R.sz.	leírás	eye size	
45560	2 x 10 m	10 x 10 cm	100

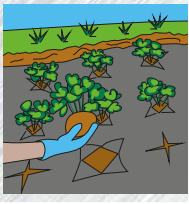

FÁTYOLFÓLIA

uv STABLE 45 g/m<sup>2</sup>

R.sz.	leírás	
45535	1,6 x 5 m	18



FÁTYOLFÓLIA

uv STABLE 50 g/m<sup>2</sup>

R.sz.	leírás	
45550	1,6 x 5 m	50
45551	1,6 x 10 m	20
45564	3,2 x 10 m	20
45552	1,6 x 50 m	egy szerepben 1
45553	1,6 x 100 m	egy szerepben 1
45562	3,2 x 50 m	egy szerepben 1
45563	3,2 x 100 m	egy szerepben 1



FÁTYOLFÓLIA

uv STABLE 50 g/m<sup>2</sup>

R.sz.	leírás	
45556	1,6 x 5 m	50
45557	1,6 x 10 m	20
45565	3,2 x 10 m	20
45558	1,6 x 50 m	egy szerepben 1
45559	1,6 x 100 m	egy szerepben 1



FÁTYOLFÓLIA

uv STABLE 17 g/m<sup>2</sup>

R.sz.	leírás	
45540	1,6 x 5 m	40
45541	1,6 x 10 m	40
45542	1,6 x 50 m	egy szerepben 1
45543	1,6 x 100 m	egy szerepben 1



RÖGZÍTŐ KERTI TAKARÓ SZÖVETEKHEZ

10x

R.sz.	leírás	
45555	11,5 cm	1



ÖSSZECŠUKHATÓ KERTISZÉK

\* for sitting and upside down for kneeling

R.sz.	leírás	
45074	58 x 48 x 28 cm	4



KERTI TÉRDEPLŐ

R.sz.	leírás	
45086	40 x 18 x 2 cm	50



**SZÓRÓ -ÜLTETŐ KOCSI**

LEÍRÁS	
magasság:	111 cm
széles:	55 cm
hangerő:	12 l

**KULTIVÁTOR, NYELEZHETŐ**

R.sz.	leírás	
45042	160 x 132 cm	12

**KULTIVÁTOR, NYELEZHETŐ**

R.sz.	leírás	
44053		12
61251	160 cm fogantyú	1

R.sz.	leírás	
45085	12 l	1



**DÉZSA**



R.sz.	leírás	
39192	30 l	20
39193	45 l	20

**LOMBGYÜJTŐ ZSÁK**

R.sz.	leírás	
45047	55 x 70 cm, 3 drzadla	20



**KERTI KOSÁR, ÖSSZECSUKHATÓ**

R.sz.	leírás	
45093	40 x 25 x 23 cm	10

**LOMBGYÜJTŐ ZSÁK**

R.sz.	leírás	
44960	200 l   60 x 60 x 55 cm	50

- PROFI ÖNTÖZÉSTECHNIKA VÁLASZTÉK
- MINŐSÉGI ANYAGOK ÉS GYÁRTÁS
- MODERN FORMÁK
- ROSA TERMÉKEKKEL KOMPATIBILIS

**FESTA®**  
AQUATIC



**FESTA®**  
AQUATIC

### LOCSOLÓPISZTOLY

- 7 funkciós
- szabályzó kar elől, rögzíthető
- könnyű vízszög vezérlés



R.s. leírás

45386



12



**FESTA®**  
AQUATIC

### LOCSOLÓPISZTOLY

- állítható vízszög
- szabályzó kar elől, rögzíthető
- könnyű vízszög vezérlés



R.s. leírás

45388



12



**FESTA®**  
AQUATIC

### SUGÁRCSŐ

- állítható vízszög



R.s. leírás

45389



24



**FESTA®**  
AQUATIC

### SUGÁRCSŐ KLT.

- állítható vízszög



R.s.

leírás

45385

4 db



12



**FESTA**  
AQUATIC

TÖMLŐ ÖSSZEKÖTŐ



1/2"

R.s. leírás

45390



24

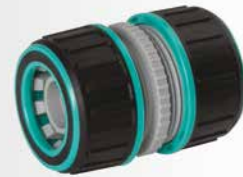

**FESTA**  
AQUATIC

TÖMLŐ ÖSSZEKÖTŐ



3/4"

R.s. leírás

45391



24



**FESTA**  
AQUATIC

GYORSCSATLAKOZÓ



1/2"

R.s. leírás

45392



24



**FESTA**  
AQUATIC

GYORSCSATLAKOZÓ



3/4"

R.s. leírás

45393



24



**FESTA**  
AQUATIC

GYORSCSATLAKOZÓ, STOPPAL



1/2"

R.s. leírás

45394



24



**FESTA**  
AQUATIC

GYORSCSATLAKOZÓ, STOPPAL



3/4"

R.s. leírás

45395



24



**FESTA**  
AQUATIC

CSAPCSATLAKOZÓ, BELSŐMENETES



1/2"

3/4"

R.s. leírás

45396



24



**FESTA**  
AQUATIC

CSAPCSATLAKOZÓ, BELSŐMENETES



3/4"

1"

R.s. leírás

45397



24

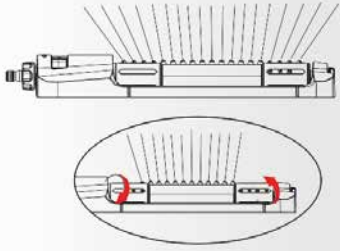

**FESTA**  
AQUATIC

## BILLENŐ LOCSOLÓ, MŰANYAG

· 19 fúvóka 8 kadbolható ( be/ki) öntöző fúvókával



R.sz. leírás

45398



6



**FESTA**  
AQUATIC

## LOCSOLÓ, 3 FORGÓVAL

· állítható locsolókarok fúvókákkal



R.sz. leírás

45399



12



**FESTA**  
AQUATIC

## ELOSZTÓ

· könnyű vízszugár vezérlés



R.sz. leírás

45400



6



**FESTA**  
AQUATIC

## ELOSZTÓ

· könnyű vízszugár vezérlés



R.sz. leírás

45401



6





# ROSA

Watering system



## ROSA LOCSOLÓPISZTOLY

- 10 funkciós
- rögzíthető

0,7 bar min  
5,5 bar max



R.s. leírás

45124

12



## ROSA LOCSOLÓPISZTOLY

- 10 funkciós
- rögzíthető
- könnyű vízszugár vezérlés

0,7 bar min  
5,5 bar max



R.s. leírás

45125

12



## ROSA LOCSOLÓPISZTOLY

- 7 funkciós
- rögzíthető

0,7 bar min  
5,5 bar max



R.s. leírás

45126

12



## ROSA LOCSOLÓPISZTOLY

- 7 funkciós
- rögzíthető
- könnyű vízszugár vezérlés

0,7 bar min  
5,5 bar max



R.s. leírás  
metal

45123

12



## ROSA LOCSOLÓPISZTOLY

- 6 funkciós
- rögzíthető
- könnyű vízszugár vezérlés

0,7 bar min  
5,5 bar max



R.s. leírás

45117

12



## ROSA LOCSOLÓPISZTOLY

- 6 funkciós
- rögzíthető
- könnyű vízszugár vezérlés

0,7 bar min  
5,5 bar max



R.s. leírás  
fém

45118

12

**ROSA****LOCSOLÓPISZTOLY**

- 5 funkciós
- rögzíthető
- könnyű vízsugár vezérlés

0,7 bar min  
5,5 bar max

R.s. leírás

45110



12

**ROSA****LOCSOLÓPISZTOLY**

- Pisztolyrész
- könnyű vízsugár vezérlés

0,7 bar min  
5,5 bar max

R.s. leírás

45116



12

**ROSA****LOCSOLÓPISZTOLY**

- fém
- rögzíthető
- könnyű vízsugár vezérlés

0,7 bar min  
5,5 bar max

R.s. leírás

45120



12

**ROSA****LOCSOLÓPISZTOLY**

- rögzíthető
- könnyű vízsugár vezérlés

0,7 bar min  
5,5 bar max

R.s. leírás

45115



12

**ROSA****LOCSOLÓPISZTOLY**

- fém
- rögzíthető
- könnyű vízsugár vezérlés

0,7 bar min  
5,5 bar max

R.s. leírás

45122 fém



12

**ROSA****LOCSOLÓPISZTOLY KÉSZLET**

- rögzíthető
- könnyű vízsugár vezérlés

0,7 bar min  
5,5 bar max

1/2"

2x

R.s. leírás

45114 1/2 hose connector



12

**ROSA****LOCSOLÓPISZTOLY**

- rögzíthető
- könnyű vízsugár vezérlés

0,7 bar min  
5,5 bar max

R.s. leírás

45111



12

**ROSA****SUGÁRCSŐ, GYORSCSATLAKOZÓS, ÁLLÍTHATÓ**

- állítható vízsugár

0,7 bar min  
5,5 bar max

R.s. leírás

45113



60



**ROSA**  
SUGÁRCSŐ, TÖMLŐCSATLAKOZÓS,  
ÁLLÍTHATÓ

0,7 bar min  
5,5 bar max

- stream lined
- clasic connection



R.s. leírás  
45112

32



**ROSA**  
LOCSOLÓPISTOLY  
KÉSZLET

- 6 funkció
- rögzíthető
- könnyű vízszugár vezérlés

0,7 bar min  
5,5 bar max

1/2" 4x



R.s. leírás  
45181

12



**ROSA**  
SUGÁRCSŐ KÉSZLET, 4 DB-OS

állítható vízszugár

0,7 bar min  
5,5 bar max

1/2" 4x



R.s. leírás  
45180

12



**ROSA**  
KÉTUTAS CSATLAKOZÓ

Elosztó szeleppel, 2 gyorscsatlakozó

0,7 bar min  
5,5 bar max



R.s. leírás  
45134

12



**ROSA**  
TÖMLŐ ÖSSZEKÖTŐ

10 bar max

1/2"



R.s. leírás  
45140

60



**ROSA**  
TÖMLŐ ÖSSZEKÖTŐ

10 bar max

1/2"



R.s. leírás  
45298

MOQ 20



**ROSA**  
GYORSCSATLAKOZÓ

10 bar max

1/2"



R.s. leírás  
45142

60



**ROSA**  
GYORSCSATLAKOZÓ

10 bar max

1/2"



R.s. leírás  
45298

MOQ 20

**ROSA**

GYORSCSATLAKOZÓ, STOPPAL



R.s. leírás

45138

60

**ROSA**

GYORSCSATLAKOZÓ STOPPOS, KÍNÁLÓ DOBOZBAN



R.s. leírás

45294

MOQ 20



MOQ 20

**ROSA**

TÖMLŐ ÖSSZEKÖTŐ



R.s. leírás

45141

60

**ROSA**

TÖMLŐÖSSZEKÖTŐ, KÍNÁLÓ DOBOZBAN



R.s. leírás

45297

MOQ 20



MOQ 20

**ROSA**

GYORSCSATLAKOZÓ



R.s. leírás

45143

60

**ROSA**

GYORSCSATLAKOZÓ, KÍNÁLÓ DOBOZBAN



R.s. leírás

45299

MOQ 20



MOQ 20

**ROSA**

GYORSCSATLAKOZÓ, STOPPAL



R.s. leírás

45139

60

**ROSA**

GYORSCSATLAKOZÓ STOPPOS, KÍNÁLÓ DOBOZBAN



R.s. leírás

45295

MOQ 20



MOQ 20



**ROSA**

CSAPCSATLAKOZÓ, BELSŐMENETES



R.s.	leírás	MOQ
45130	1/2" + 3/4"	60
45131	3/4" + 1"	60



**ROSA**

CSAPCSATLAKOZÓ, BELSŐMENETES, KINÁLÓ DOBOZBAN



R.s.	leírás	MOQ
45289	1/2" + 3/4"	MOQ 20
45290	3/4" + 1"	MOQ 20

**ROSA**

CSATLAKOZÓ KÉSZLET



2x



R.s.	leírás	MOQ
45144		60



**ROSA**

SZŰKÍTŐ



R.s.	leírás	MOQ
45213	1/2" - 3/4"	60



**ROSA**

CSAPCSATLAKOZÓ, KÜLSŐMENETES

• Egyszerű csatlakozódugó Szeleppel



R.s.	leírás	MOQ
45135		60



**ROSA**

CSAPCSATLAKOZÓ, BILINCCSEL



R.s.	leírás	MOQ
45145		60



**ROSA**

CSAPCSATLAKOZÓ, BELSŐMENETES



R.s.	leírás	MOQ
45132		60



**ROSA**

CSAPCSATLAKOZÓ, BELSŐMENETES, KINÁLÓ DOBOZBAN



R.s.	leírás	MOQ
45291		MOQ 20



ROSA

CSAPCSATLAKOZÓ, KÜLSŐMENETES

10 bar max

3/4"

R.s.

leírás



45133

60



ROSA

CSAPCSATLAKOZÓ,  
KÜLSŐMENETES,  
KÍNÁLÓ DOBOZBAN

10 bar max

3/4"

R.s.

leírás



45292

MOQ 20



ROSA

KUPLUNG CSATLAKOZÓ

10 bar max

R.s.

leírás



45136

60



ROSA

KUPLUNGCSATLAKOZÓ,  
KÍNÁLÓ DOBOZBAN

10 bar max

R.s.

leírás



45293

MOQ 20



ROSA

„Y” ELÁGAZÓ

10 bar max

R.s.

leírás



45137

60



ROSA

ADAPTER

10 bar max

1"

R.s.

leírás



45215

48



ROSA

TÖMLŐ ÖSSZEKÖTŐ

10 bar max

1"

R.s.

leírás



45218

48



ROSA

GYORSCSATLAKOZÓ

10 bar max

1"

R.s.

leírás



45219

48



**ROSA**  
SZŰKÍTŐ



R.s. 45216

leírás



48



**ROSA**  
ADAPTER



R.s. 45217

leírás



48

**ROSA**  
KÍNÁLÓ KÉSZLET

· Csomag tartalma

- 45113 15 szt. | kom
- 45117 10 szt. | kom
- 45120 15 szt. | kom
- 45132 40 szt. | kom
- 45131 40 szt. | kom
- 45133 40 szt. | kom
- 45142 25 szt. | kom
- 45143 20 szt. | kom
- 45140 20 szt. | kom

225x



R.s. 45146

leírás



1



**ROSA**  
SUGÁRCSŐ, ÁLLÍTHATÓ

· állítható vízsugár



R.s. 45214

leírás



48

**ROSA**  
PULZÁLÓ  
LOCSOLÓTALP, FORFI

· impulse



R.s. 45162

leírás



24



**ROSA**  
LOCSOLÓTALP 8 FUNKCIÓS

· 8 function



R.s. 45154

leírás



48



**ROSA**  
LOCSOLÓ,  
2 FORGÓVAL

· rotary, 2 arms



R.s. 45153

leírás



24



**ROSA**  
LOCSOLÓ,  
3 FORGÓVAL

· rotary, 3 arms



R.s. 45152

leírás



24



**ROSA****BILLENŐ LOCSOLÓ, MŰANYAG**

· 17 jets ALU

0,7 bar min  
5,5 bar max

ALU



R.s. leírás

45158

6

**ROSA****LOCSOLÓPIRAMIS**

· pyramidal

0,7 bar min  
5,5 bar max

R.s. leírás

45167

12

**ROSA****LOCSOLÓ, ESŐZTETŐ, LESZHÚRHATÓ**

· plastic point

0,7 bar min  
5,5 bar max

R.s. leírás

45160

25

**ROSA****CSERÉPLOCSOLÓ**

· cserép locsoló

0,7 bar min  
5,5 bar max

R.s. leírás

45156

12

**ROSA****LOCSOLÓTALP**0,7 bar min  
5,5 bar max

R.s. leírás

45155

24

**ROSA****LOCSOLÓ, PULZÁLÓ, ÁLLVÁNYOS**

· tripod

0,7 bar min  
5,5 bar max

R.s. leírás

45163 impulse, tripod

20

**ROSA****IDŐZÍTŐ**

· 0 - 120 min.

0,7 bar min  
5,5 bar max

R.s. leírás

45147

24

**ROSA****LOCSOLÓ, PULZÁLÓ, RÉZ, MENÉTES**

· brass

0,7 bar min  
5,5 bar max

R.s. leírás

45150

12





**ROSA**

LOCSOLÓ, PULZÁLÓ, MŰA., MENETES



R.s. leírás

45151



12



**ROSA**

LOCSOLÓ, PULZÁLÓ, MŰA., LESZÚRHATÓ



R.s. leírás

45168 plastic point

45169 metal point



12

12



**ROSA**

LOCSOLÓ, PULZÁLÓ, LESZÚRHATÓ



R.s. leírás

45161

plastic point



20



**ROSA**

LOCSOLÓ, FORGÓ, LESZÚRHATÓ

· 3 arms



R.s. leírás

45164 plastic point



12



**ROSA**

LESZÚRÓ, FÉM



R.s. leírás

45159



12



**ROSA**

LESZÚRÓ MŰANYAG



R.s. leírás

45179



12



**ROSA**

TÖMLŐVEZETŐ

R.s. leírás

45186



48



**ROSA**

SZAKASZOS LOCSOLÓ, FÉM



R.s. leírás

45185



20

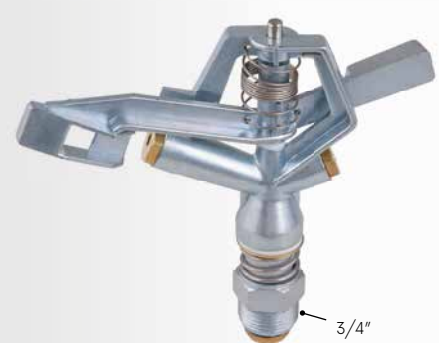

**ROSA**

SZAKASZOS LOCSOLÓ, FÉM



R.s. leírás

45184



20

**ROSA**

**1/2" GYŰRŰ KÉSZLET**

· Tételekhez

- 45110, 45111, 45118,
- 45120, 45121, 45123,
- 45125, 45126, 45130,
- 45131, 45132, 45134,
- 45135, 45152, 45153,
- 45154, 45155, 45156,
- 45162, 45177, 45178,
- 45180, 45196, 45197,
- 45198



**ROSA**

**1/2" GYŰRŰ**

**50x**

R.sz.	leírás	
45175		1

R.sz.	leírás	
45187		1



**ROSA**

**TÖMLŐTARTÓ DOB**

· hose included 1/2" 20 m

0,7bar min	
5,5bar max	1/2"

**ROSA**

**TÖMLŐTARTÓ FALRA SZERELHETŐ**



R.sz.	leírás	
45182	1/2" 40 m	4

R.sz.	leírás	
45176		1



**ROSA**

**TÖMLŐTARTÓ KOCSI, MŰANYAG**



R.sz.	leírás	
45183	1/2" 60 m	5

**ROSA**

**TÖMLŐTARTÓ KOCSI, MŰANYAG**



R.sz.	leírás	
45177	1/2" 60 m	5

**ROSA**

**TÖMLŐTARTÓ, TALPAS**



R.sz.	leírás	
45178	1/2" 60 m	5



**ROSA**  
KERTI ZUHANYZÓ,  
LESZÚRHATÓ

0,7bar min  
5,5bar max

R.s.	leírás	
45171	adjustable	12



**ROSA**  
KERTI ZUHANYZÓ, 3 LÁBAS

0,7bar min  
5,5bar max

R.s.	leírás	
45170	tripod	6



**ROSA**  
LOCSOLÓ FEJ, HOSSZABBÍTÓ

0,7bar min  
5,5bar max

R.s.	leírás	
45172	záróval	12
45173	10 funkció	12



**ROSA**  
TÖMLŐTARTÓ

R.s.	leírás	
45174		60



**KERTI TÖMLŐ TISZTA**

R.s.	leírás	
45345	1/2" 25 m	1
45349	3/4" 25 m	1
45353	1" 25 m	1



**KERTI TÖMLŐ**

R.s.	leírás	
45360	1/2" 25 m	1
45364	3/4" 25 m	1
45366	1" 25 m	1



**ROSA**  
SPIRÁL TÖMLŐ

0,7bar min  
5,5bar max

R.s.	leírás	
45300	7,5 m	6
45301	15 m	8



**TÖMLŐHORDOZÓ**

· kertü műanyag cső, 30 m, 1/2"

R.s.	leírás	
45350	Max. 20 kg	1



**ROSA**  
TÖMLŐ ÖSSZEKÖTŐ



R.s. leírás 48  
45192



**ROSA**  
GYORSCSATLAKOZÓ



R.s. leírás 48  
45194



**ROSA**  
GYORSCSATLAKOZÓ,  
STOPPAL



R.s. leírás 48  
45190



**ROSA**  
TÖMLŐ ÖSSZEKÖTŐ



R.s. leírás 48  
45193



**ROSA**  
GYORSCSATLAKOZÓ



R.s. leírás 48  
45195



**ROSA**  
GYORSCSATLAKOZÓ,  
STOPPAL



R.s. leírás 48  
45191



**ROSA**  
CSAPCSATLAKOZÓ



R.s. leírás 48  
45196 belsomenetes 1/2" + 3/4"



**ROSA**  
CSAPCSATLAKOZÓ



R.s. leírás 48  
45197 belsomenetes 3/4"



**ROSA**  
CSAPCSATLAKOZÓ



R.s. leírás 48  
45199 belsomenetes 1"



**ROSA**  
CSAPCSATLAKOZÓ



R.s. leírás 48  
45198 belsomenetes 3/4 + 1"



**ROSA**  
CSAPCSATLAKOZÓ



R.s. leírás 48  
45200 külsomenetes 3/4"



**ROSA**  
SUGÁRCSO, ÁLLÍTHATÓ



R.s. leírás 48  
45206 állítható vízszugár



ROSA

ÖSSZEKÖTŐ



R.s.	leírás	
45203	2-utas elosztó	48



ROSA

HÁROMUTAS ELOSZTÓ



R.s.	leírás	
45204	háromutas elosztó	48



TÖMLŐ ÖSSZEKÖTŐ



R.s.	leírás	
45211	1", závit 1"	25



TÖMLŐ ÖSSZEKÖTŐ, CSAPOS

R.s.	leírás	
45220	1/2" szál 3/4"	10
45221	3/4" szál 1"	10
45222	1" szál 1"	10

CSAPCSATLAKOZÓ, LAPOS

R.s.	leírás	
45223	1/2" szál 3/4"	10
45224	3/4" szál 1"	10
45225	1" szál 1"	10



SZÜKÍTŐ, CSAPOS

R.s.	leírás	
45226	1/2" - 3/4" szál 1"	10
45227	1" - 3/4" szál 1"	10
45228	1" - 1/2" szál 1"	10

SUGÁRCSŐ, CSAPOS

R.s.	leírás	
45229		10



TÖMLŐ BILINCS

R.s.	diameter	
45600	8 - 12 mm	2
45601	10 - 16 mm	2
45602	12 - 20 mm	2

R.s.	diameter	
45603	16 - 25 mm	2
45604	20 - 32 mm	2
45605	25 - 40 mm	2
45606	30 - 45 mm	2
45607	32 - 50 mm	2
45608	40 - 60 mm	2
45609	50 - 70 mm	2
45610	60 - 80 mm	2
45611	70 - 90 mm	2
45612	80 - 100 mm	2
45613	90 - 110 mm	2
45614	100 - 120 mm	2
45615	110 - 130 mm	2
45616	120 - 140 mm	2
45617	130 - 150 mm	2
45618	140 - 160 mm	2
45619	150 - 170 mm	2



TÖMLŐ BILINCS

R.s.	diameter	szélesség	
45620	8 - 12 mm	9 mm	2
45621	10 - 16 mm	9 mm	2
45622	12 - 20 mm	9 mm	2

R.s.	diameter	szélesség	
45623	16 - 25 mm	9 mm	2
45624	20 - 32 mm	9 mm	2
45625	25 - 40 mm	12 mm	2
45626	30 - 45 mm	12 mm	2
45627	32 - 50 mm	12 mm	2
45628	40 - 60 mm	12 mm	2
45629	50 - 70 mm	12 mm	2
45630	60 - 80 mm	12 mm	2
45631	70 - 90 mm	12 mm	2
45632	80 - 100 mm	12 mm	2
45633	90 - 110 mm	12 mm	2
45634	100 - 120 mm	12 mm	2
45635	110 - 130 mm	12 mm	2
45636	120 - 140 mm	12 mm	2
45637	130 - 150 mm	12 mm	2
45638	140 - 160 mm	12 mm	2
45639	150 - 170 mm	12 mm	2



## KERTI SZELEP ÉS KERTI EWER



## KERTI CSAP

R.s.	leírás	
45105		8



## KERTI CSAP

R.s.	leírás	
45100	1/2"	12
45101	3/4"	10
45102	1"	6

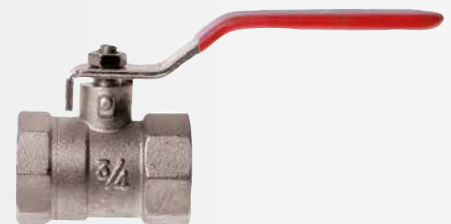

## KERTI GOLYÓS CSAP

R.s.	leírás	
45106	1/2"	12
45107	3/4"	10
45108	1"	8



## FALI CSAP DERÉKSZÖGŰ

R.s.	leírás	
45104	1/2" x 3/8"	10



## ÖNTÖZŐKANNA



R.s.	leírás	
45280	2,5 l	10
45283	5 l	10
45285	10 l	10
45286	12 l	10
45287	15 l	10



**FESTA**  
PERMETEZŐ

max. nyomás	2,5 Bar
kötet	12 l
permetező tömlő hossza	3 m
méretek	32 x 25 x 59 cm

R.sz.	leírás	
45249	kézi permetező 12 l	1
45273	cseré fűvóka	1
45274	cseré permetező szár	1



**FESTA**  
NAGYNYOMÁSÚ MOSÓ

tápfeszültség:	230 V/50 Hz
teljesítmény	1500 W
max. nyomás	120 Bar
munka nyomás	80 Bar
víz áramlás	6 l
töltő hossz	5 m
védettség:	IPX5
Funkció	Auto Stop

R.sz.	leírás	
45270	nagynyomású mosó	1
45271	cseré fűvóka	1
45272	waz zapasowy do opryskiwacza	1



**FESTA**  
PERMETEZŐ

R.sz.	leírás	
45247	12 l	1
45248	16 l	1

R.sz.	leírás	
45263	tartalék tömlő	1
45251	tartalék készlet	1
45254	pótfűvóka	1
45257	tartalék fogantyú	1
45260	Pótoszlop - 370 mm	1
45267	Pótoszlop 45 - 250 cm	1
45268	Pótoszlop 65 - 260 cm	1



**FESTA**  
KÉZI PERMETEZŐ

R.sz.	leírás	
45244	3 l	6
45245	5 l	6
45246	8 l	6

R.sz.	leírás	
45262	tartalék tömlő	1
45250	tartalék készlet	1
45253	pótfűvóka	1
45256	tartalék fogantyú	1
45261	pótoszlop - 370 mm	1



**FESTA****KÉZI PERMETEZŐ**

R.sz.	type	
45242	1,5 l	20
45241	2 l	20

**KÉZI PERMETEZŐ**

R.sz.	type	
45239	0,5 l	1
45240	0,7 l	1

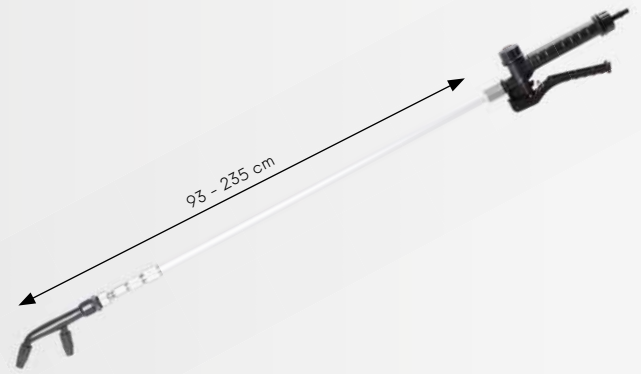
**TELESZKOPÓS PERMETEZŐ CSŐ**

R.sz.	type	
45267	45 - 250 cm	inox 1
45268	65 - 260 cm	fiberglass 1

**TELESZKOPÓS PERMETEZŐ CSŐ**

R.sz.	leírás	
45269		1

**TARTALÉK TÖMLŐ PERMETEZŐHÖZ**

R.sz.	type	
45263	permetezőhöz 45247, 45248	1
45262	permetezőhöz 45244, 45245, 45246	1

**GYOMÍRTÓ HARANG**

R.sz.	size	dugosc	szélesség	wysokosc	
45265	kicsi	230 mm	90 mm	130 mm	1
45266	nagy	370 mm	140 mm	200 mm	1





GRABIE



**FESTA**  
MŰANYAG GEREBLYE

R.s.	lécek száma	szélesség	wysokosc	
45327	13	240 mm	200 mm	12



**FESTA**  
MŰANYAG GEREBLYE AL. NYÉLLEL

MOQ  
3

R.s.	lécek száma	fogantyú hossza	
61136	13	160 cm	3
61147	13	100 cm	3



**FESTA**  
MŰANYAG GEREBLYE

R.s.	lécek száma	szélesség	wysokosc	
45328	23	480 mm	280 mm	12



**FESTA**  
MŰANYAG GEREBLYE AL. NYÉLLEL

MOQ  
3

R.s.	lécek száma	fogantyú hossza	
61137	23	160 cm	3
61148	23	100 cm	3



**FESTA**  
MŰANYAG GEREBLYE

R.s.	lécek száma	szélesség	wysokosc	
45329	35	760 mm	310 mm	1



**FESTA**  
MŰANYAG GEREBLYE AL. NYÉLLEL

MOQ  
3

R.s.	lécek száma	fogantyú hossza	
61138	35	160 cm	3

**FESTA**

## MŰANYAG GEREBLYE

R.sz.	lécek száma	szélesség	
45325	12	410 mm	12

**FESTA**

## MŰANYAG GEREBLYE AL. NYÉLLEL

MOQ  
3

R.sz.	lécek száma	fogantyú hossza	
61139	12	160 cm	3

**FESTA**

## MŰANYAG GEREBLYE

R.sz.	lécek száma	szélesség	
45326	18	580 mm	12

**FESTA**

## MŰANYAG GEREBLYE AL. NYÉLLEL

MOQ  
3

R.sz.	lécek száma	fogantyú hossza	
61140	18	160 cm	3



## BETONSEPRŰ

R.sz.	leírás	
45323	37 cm	16



## BETONSEPRŰ AL. NYÉLLEL

MOQ  
3

R.sz.	leírás	fogantyú hossza	
61149	37 cm	160 cm (45330)	3

**FESTA**

## LOMBSEPRŰ, FÉM, ÁLLÍTHATÓ

Zn

R.sz.	lécek száma	dugósc	
44965	15	200 - 590 mm	12



## LOMBSEPRŰ, FÉM, ÁLLÍTHATÓ

Zn

R.sz.	lécek száma	waga	dugósc	
45050	15	1200 g	200 - 590 mm	25



**FESTA**

LOMBSEPRŰ, FÉM

· spring steel

R.sz.	szélesség	lécek száma	
45071	55 cm	22	1



**FESTA**

LOMBSEPRŰ, FA NYÉLLEL

MOQ  
3

R.sz.	szélesség	fogantyú hossza	
61150	55 cm	160 cm	3



LOMBSEPRŰ, FÉM

R.sz.	szélesség	lécek száma	
45051	40 cm	22	60



LOMBSEPRŰ, FA NYÉLLEL

MOQ  
3

R.sz.	szélesség	fogantyú hossza	
61130	40 cm	160 cm	3



LOMBSEPRŰ, FÉM

R.sz.	szélesség	lécek száma	
45052	45 cm	22	36



LOMBSEPRŰ, FA NYÉLLEL

MOQ  
3

R.sz.	szélesség	fogantyú hossza	
61131	45 cm	160 cm	3



MŰANYAG LOMBSEPRŰ

MADE IN  
EU

R.sz.	szélesség	lécek száma	
45320	60 cm	24	10



MŰANYAG LOMBSEPRŰ, FA NYÉLLEL

MADE IN  
EU

MOQ  
3

R.sz.	szélesség	lécek száma	fogantyú hossza	
61132	60 cm	24	160 cm	3



MŰANYAG LOMBSEPRŰ

MADE IN  
EU

R.sz.	szélesség	lécek száma	
45055	50 cm	22	10



MŰANYAG LOMBSEPRŰ, FA NYÉLLEL

MADE IN  
EU

MOQ  
3

R.sz.	szélesség	lécek száma	fogantyú hossza	
61133	50 cm	22	160 cm	3



MŰANYAG LOMBSEPRŰ



R.sz.	szélesség	lécek száma	
45321	40 cm	23	20



MŰANYAG LOMBSEPRŰ, FA NYÉLLEL



R.sz.	lécek száma	fogantyú hossza	
61134	23	160 cm	3

MOQ  
3

MŰANYAG LOMBSEPRŰ



R.sz.	szélesség	lécek száma	
45054	40 cm	23	10



MŰANYAG LOMBSEPRŰ, FA NYÉLLEL



R.sz.	szélesség	lécek száma	fogantyú hossza	
61135	40 cm	23	160 cm	3

MOQ  
3

MŰANYAG GEREBLYE



R.sz.	szélesség	lécek száma	
45053	58 cm	16	35



MŰANYAG GEREBLYE, FA NYÉLLEL



R.sz.	szélesség	lécek száma	fogantyú hossza	
61141	58 cm	16	160 cm	3

MOQ  
3

MŰANYAG GEREBLYE



R.sz.	szélesség	fogak száma	
45070	41 cm	14	4



MŰANYAG GEREBLYE, FA NYÉLLEL



R.sz.	szélesség	fogak száma	fogantyú hossza	
61142	41 cm	14	160 cm	3

MOQ  
3

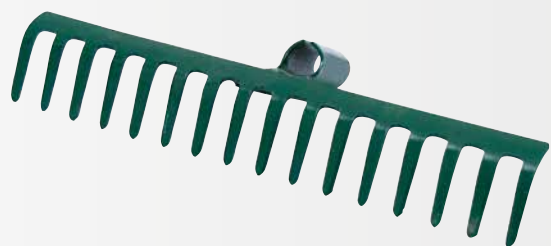

GEREBLYE FÉM

R.s.	szélesség	fogak száma	
61030	24 cm	10	24
61031	29 cm	12	24
61032	34 cm	14	24
61033	40 cm	16	24



GEREBLYE, FÉM, FA NYÉLLEL

MOQ  
3

R.s.	szélesség	fogak száma	fogantyú hossza	
61060	24 cm	10	160 cm	3
61061	29 cm	12	160 cm	3
61062	34 cm	14	160 cm	3
61063	40 cm	16	160 cm	3



GEREBLYE FÉM

· kalapács festék

R.s.	szélesség	fogak száma	
61045	30 cm	12	25
61046	39 cm	14	25
61047	45 cm	16	25



GEREBLYE, FÉM, FA NYÉLLEL

· kalapács festék

MOQ  
3

R.s.	szélesség	fogak száma	fogantyú hossza	
61143	30 cm	12	160 cm	3
61144	39 cm	14	160 cm	3
61145	45 cm	16	160 cm	3



GYEP SZELLŐZTETŐ

R.s.	szélesség	fogak száma	
61048	35 cm	11   21	12



GYEP SZELLŐZTETŐ, FA NYÉLLEL

MOQ  
3

R.s.	szélesség	fogak száma	fogantyú hossza	
61146	35 cm	11   21	160 cm	3



GEREBLYE, FÉM, ÜVEGSZÁLAS NYÉLLEL

MOQ  
3

R.s.	szélesség	fogak száma	fogantyú hossza	
61034	34 cm	14	160 cm	3



# ÁSÓ ÉS LAPÁT



# FESTA®

**FESTA®**

## HEGYES ÁSÓ

· Alkalmos üvegházban történő munkához

R.s.	leírás	fogantyú hossza	
61008	19 x 28 cm	85 cm	5



**FESTA®**

## ÁSÓ, LAPOS

R.s.	leírás	fogantyú hossza	
61005	20 x 29 cm	120 cm	5

**FESTA®**

## HEGYES ÁSÓ

R.s.	leírás	fogantyú hossza	
61006	19 x 28 cm	120 cm	5

**FESTA®**

## ÁSÓ, LAPOS

· vagy 180 cm-nél nagyobb személyeknél

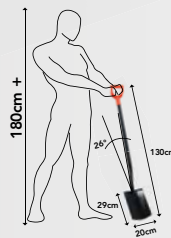



R.s.	leírás	fogantyú hossza	
61157	20 x 29 cm	130 cm	5

**FESTA®**

## HEGYES ÁSÓ

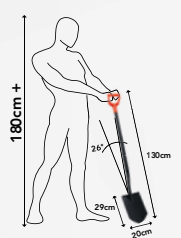
· vagy 180 cm-nél nagyobb személyeknél



R.s.	leírás	fogantyú hossza	
61158	19 x 28 cm	130 cm	5



**FESTA®**

## LAPÁT

R.s.	leírás	fogantyú hossza	
61155	24 x 29 cm	120 cm	5

**FESTA®**

## VILLA

R.s.	leírás	fogantyú hossza	
61156	19 x 28 cm	130 cm	5



**FESTA**

VILLA

R.sz.	leírás	fogantyú hossza	
61007	18 x 28 cm	130 cm	5



VILLA

R.sz.	leírás	fogantyú hossza	
61010	18 x 30 cm	95 cm	12



ÁSÓ HEGYES ÜVEGSZÁLAS NYÉLLEL

R.sz.	leírás	fogantyú hossza	
61029	19 x 30 cm	95 cm	12



LAPÁT ÜVEGSZÁLAS NYÉLLEL

R.sz.	leírás	fogantyú hossza	
61015	19 x 30 cm	95 cm	12



LAPÁT ALU



R.sz.	leírás	
61026	26 x 29 cm	10
61025	34 x 30 cm	10



LAPÁT ALU, FA NYÉLLEL

· bükk nyél



MOQ  
3

R.sz.	leírás	fogantyú hossza	
61057	26 x 29 cm	130 cm	3
61056	34 x 30 cm	130 cm	3



LAPÁT

R.sz.	leírás	
61021	35 x 35 cm	10



LAPÁT FA NYÉLLEL

MOQ  
3

R.sz.	leírás	fogantyú hossza	
61089	35 x 35 cm	130 cm	3



### ÁSÓLAPÁT FA NYÉLLEL

- kalapács festék
- Bükk fa nyél

MOQ  
3

R.sz.	leírás	fogantyú hossza	
61050	26 x 28 cm	130 cm	3

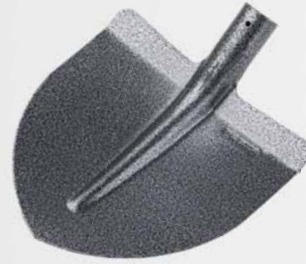

### ÁSÓLAPÁT

- kalapács festék

R.sz.	leírás	
61000	26 x 28 cm	12



### ÁSÓLAPÁT FA NYÉLLEL

- Bükk fogantyú

MOQ  
3

R.sz.	leírás	fogantyú hossza	
61088	26 x 28 cm	130 cm	3



### ÁSÓLAPÁT

R.sz.	leírás	
61020	26 x 28 cm	12



### LAPÁT FA NYÉLLEL

- kalapács festék
- Bükk fa nyél

MOQ  
3

R.sz.	leírás	fogantyú hossza	
61051	24 x 29 cm	130 cm	3



### LAPÁT

- kalapács festék

R.sz.	leírás	
61001	24 x 29 cm	12



### LAPÁT FA NYÉLLEL

- Bükk fa nyél

MOQ  
3

R.sz.	leírás	fogantyú hossza	
61090	24 x 29 cm	130 cm	3
61053	24 x 29 cm	130 cm "T <sub>n</sub> " fogantyú	3



### LAPÁT

R.sz.	leírás	
61022	24 x 29 cm	12







## HOLSTEIN LAPÁT

R.sz.	leírás	
61058	25 x 27 cm	12



## HOLSTEIN LAPÁT FA NYÉLLEL

· Bükk fa nyél

MOQ  
3

R.sz.	leírás	fogantyú hossza	
61059	25 x 27 cm	130 cm	3



## LAPÁT

· kalapács festék

R.sz.	leírás	
61002	19 x 27 cm	12



## LAPÁT FA NYÉLLEL

· kalapács festék  
· Bükk fa nyél

MOQ  
3

R.sz.	leírás	fogantyú hossza	
61052	19 x 27 cm	130 cm	3



## LAPÁT

R.sz.	leírás	
61024	19 x 27 cm	12



## LAPÁT FA NYÉLLEL

R.sz.	leírás	fogantyú hossza	
61054	19 x 27 cm	130 cm	3

MOQ  
3



## ÁSÓ HEGYES

· kalapács festék

R.sz.	leírás	
61004	22 x 30 cm	12



## ÁSÓ HEGYES, FA NYÉLLEL

· kalapács festék

R.sz.	leírás	fogantyú hossza	
61161	22 x 30 cm	90 cm	3

MOQ  
3



### ÁSÓ HEGYES, FA NYÉLLEL

MOQ  
3

R.s.	leírás	fogantyú hossza	MOQ
61097	19 x 30 cm	90 cm	3



### ÁSÓ LEMEZ

R.s.	leírás	MOQ
61019	22 x 30 cm	12



### KOVÁCSOLT ÁSÓ, FA NYÉLLEL

R.s.	leírás	fogantyú hossza	MOQ
61162	22 x 25 cm	90 cm	3
61223	fogantyú	90 cm	1



### KOVÁCSOLT ÁSÓ

R.s.	leírás	MOQ
61013	22 x 25 cm	12



### ÁSÓ ÍVES, FA NYÉLLEL

· kalapács festék

MOQ  
3

R.s.	leírás	fogantyú hossza	MOQ
61163	21 x 30 cm	90 cm	3



### ÁSÓ ÍVES

· kalapács festék

R.s.	leírás	MOQ
61003	21 x 30 cm	12



### ÁSÓ ÍVES, FA NYÉLLEL

MOQ  
3

R.s.	leírás	fogantyú hossza	MOQ
61098	21 x 30 cm	90 cm	3



### ÁSÓ FEKETE ÍVES

R.s.	leírás	MOQ
61018	21 x 30 cm	12





FAISKOLAI LAPÁT

R.s.	leírás	MOQ
61014	14 x 37 cm	12



FAISKOLAI LAPÁT, FA NYÉLLEL

R.s.	leírás	fogantyú hossza	MOQ
61164	14 x 37 cm	90 cm	3
61203	fa nyél	90 cm	1



VILLA

R.s.	leírás	MOQ
61009	20 x 32 cm	12



VILLA FA NYÉLLEL

R.s.	leírás	fogantyú hossza	MOQ
61165	20 x 32 cm	90 cm	3



KOVÁCSOLT ÁSÓVILLA

R.s.	leírás	MOQ
61012	22 x 30 cm	12



KOVÁCSOLT ÁSÓVILLA, FA NYÉLLEL

R.s.	leírás	fogantyú hossza	MOQ
61166	22 x 30 cm	90 cm	3
61222	fa nyél	90 cm	1



KOVÁCSOLT VILLA

R.s.	leírás	MOQ
61044	20 x 30 cm	12



KOVÁCSOLT VILLA, FA NYÉLLEL

R.s.	leírás	fogantyú hossza	MOQ
61028	20 x 30 cm	90 cm	3
61209	fa nyél	90 cm	1

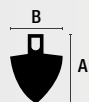

### KOVÁCSOLT KAPA, HEGYES, FA NYÉLLEL

R.sz.	leírás	fogantyú hossza	MOQ	
61111	0,4 kg	120 cm	3	
61112	0,6 kg	120 cm	3	
61224	fa nyél	120 cm	1	

### KAPA HEGYES

R.sz.	leírás	A	B	
61035	0,4 kg	180 mm	125 mm	1
61036	0,6 kg	230 mm	160 mm	30

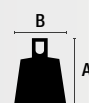

### KOVÁCSOLT RÉPA KAPA, FA NYÉLLEL

R.sz.	leírás	fogantyú hossza	MOQ	
61114	0,6 kg	120 cm	3	
61224	fa nyél	120 cm	1	

### RÉPA KAPA

R.sz.	leírás	A	B	
61038	0,6 kg	165 mm	135 mm	20



MOQ  
3



### CSÁKÁNY FA NYÉLLEL

R.sz.	leírás	fogantyú hossza	MOQ	
61121	1,5 kg	95 cm	3	
61042	2,5 kg	95 cm	3	

### CSÁKÁNY

R.sz.	leírás	MOQ	
61120	1,5 kg	6	
61040	2,5 kg	6	





IRTÓKAPA

R.sz.	leírás	
61067	75 mm	1
61068	125 mm	1
61069	175 mm	1



IRTÓKAPA, FA NYÉLLEL

MOQ  
3

R.sz.	leírás	fogantyú hossza	
61290	75 mm	120 cm	3
61291	125 mm	120 cm	3
61292	175 mm	120 cm	3



KAPA HEGYES

R.sz.	leírás	
61070	140 mm	40



KAPA, HEGYES, FA NYÉLLEL

MOQ  
3

R.sz.	leírás	fogantyú hossza	
61293	140 mm	120 cm	3



KERTI KAPA, LAPOS

R.sz.	leírás	fogantyú hossza	
61294	140 mm	27 cm	MOQ 3
61221	fa nyél	27 cm	1



KERTI KAPA, HEGYES

R.sz.	leírás	fogantyú hossza	
61295	140 mm	27 cm	MOQ 3
61221	fa nyél	27 cm	1



KERTI HOROLÓ

R.sz.	leírás	fogantyú hossza	
61296	175 mm	27 cm	MOQ 3
61221	fa nyél	27 cm	1



KERTI KAPARÓ

R.sz.	leírás	fogantyú hossza	
61297		27 cm	MOQ 3
61221	fa nyél	27 cm	1



120 cm

80 cm



• Szemléltető fotó

## BEMUTATÓ ÁLLVÁNY LAPÁT ÉS ÁSÓ

R.sz.	leírás	
61077	állvány ásónak és lapátnak	1
61079	állvány raklap	1



• Szemléltető fotó

## KERTI SZERSZÁM TARTÓ

R.sz.	leírás	
51185	45 cm	15



• forgó gumiabroncsok

## KERTI SZERSZÁM TARTÓ

5x

R.sz.	leírás	
51184		12



## SARLÓ

R.sz.	leírás	
45490	450 mm	1



**FESTA**  
ACÉL KEFE

R.sz.	leírás	
22135	6 x 19 cm fogantyú nélkül	8
22137	6 x 19 cm fogantyúval 140 cm	MOQ 3



**FESTA**  
NYLON KEFE

R.sz.	leírás	
22136	6 x 19 cm fogantyú nélkül	8
22138	6 x 19 cm fogantyúval 140 cm	MOQ 3



ACÉLKEFE FA NYÉLLEL,  
FUGA TISZTÍTÁSHOZ

R.sz.	fogantyú hossza	
52198	140 cm	1



SEPRŰ  
MADE IN EU

R.sz.	leírás	
52119	29 cm	24



SZEMÉTLAPÁT ÉS SEPRŰ

MADE IN EU

R.sz.	leírás	
52168		26



SZEMÉTLAPÁT ÉS SEPRŰ

MADE IN EU

R.sz.	leírás	
52173		26



**FESTA**  
SZEMÉTLAPÁT

R.sz.	leírás	
52176	22 x 23 cm	24



SZEMÉTLAPÁT

Zn

R.sz.	leírás	
52175	22 x 23 cm	50

## BETONSEPRŰ FA NYÉLLEL



R.sz.	leírás	MOQ
52197	30 cm 120 cm fa	3



## BETONSEPRŰ



R.sz.	leírás		
52108	30 cm	fekete	25
61172	nyél 120 cm	fekete	1

## BETONSEPRŰ FÉM NYÉLLEL

R.sz.	leírás	fogantyú hossza	MOQ
61149	37 cm	160 cm	3



## BETONSEPRŰ

R.sz.	leírás	MOQ
45323	37 cm	16

## BETONSEPRŰ FA NYÉLLEL



R.sz.	leírás	fogantyú hossza	MOQ
52190	30 cm	150 cm	3
52191	40 cm	150 cm	3
52192	50 cm	150 cm	3
52193	60 cm	150 cm	3
52194	80 cm	150 cm	3

## BETONSEPRŰ



R.sz.	leírás	MOQ
52101	30 cm	10
52102	40 cm	10
52103	50 cm	10
52104	60 cm	10
52105	80 cm	10

## BETONSEPRŰ FA NYÉLLEL



R.sz.	leírás	fogantyú hossza	MOQ
52185	40 cm	150 cm	3
52186	50 cm	150 cm	3
52187	60 cm	150 cm	3
52188	70 cm	150 cm	3
52189	80 cm	150 cm	3

## BETONSEPRŰ



R.sz.	leírás	MOQ
52160	40 cm	10
52161	50 cm	10
52162	60 cm	10
52163	70 cm	10
52164	80 cm	10





## PARTVIS



R.sz.	leírás		
52114	28 cm fekete		1



## PARTVIS FA NYÉLLEL



R.sz.	leírás	fogantyú hossza	
52116	28 cm	130 cm	3

MOQ  
3



## PARTVIS



R.sz.	leírás		
52113	30 cm fekete		26
52115	30 cm menet nélkül		26



## PARTVIS FA NYÉLLEL



R.sz.	leírás		
52195	30 cm 150 cm fa		3
52196	30 cm 130 cm ALU		3

MOQ  
3



Ø 23 mm

## LEHÚZÓGUMI

R.sz.	leírás		
15886	450 mm nyé Ø 23 mm		48
15887	600 mm nyé Ø 23 mm		48
15888	750 mm nyé Ø 23 mm		32

## ÚTTEST SEPRŰ



R.sz.	leírás		
52109	25 cm 120 cm fa		12

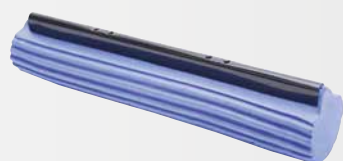
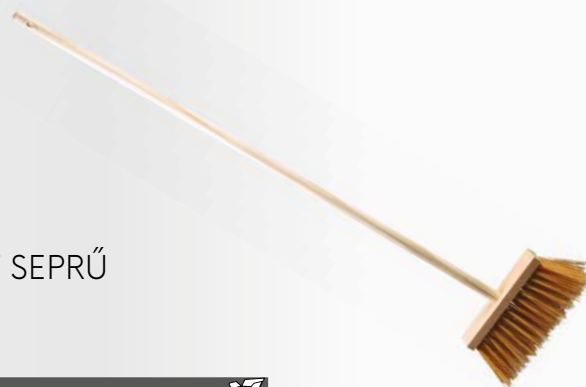

## TARTALÉK MOP

R.sz.	leírás		
52111	30 cm		1



## FELMOSÓ MOP

R.sz.	leírás		
52110	30 cm		16



## HÓLAPÁT

**FESTA**

## HÓLAPÁT

R.sz.	leírás	
60006	46 x 34 cm	12
60206	46 x 34 cm, összeszerelt	1

**FESTA**

## HÓLAPÁT

R.sz.	leírás	
60008	50 x 34 cm	12
60208	50 x 34 cm, összeszerelt	1



## HÓLAPÁT



R.sz.	leírás	
60001	48 x 40 cm	10
60201	48 x 40 cm, összeszerelt	1



## HÓLAPÁT

**ALU**

R.sz.	leírás	
60012	50 x 38 cm	12
60212	50 x 38 cm, összeszerelt	1



JÉGTÖRŐ

MOQ  
3

R.sz.	leírás	
60022	20 cm	3



JÉGTÖRŐ

R.sz.	leírás	
60018	15 cm	20
60019	20 cm	24
60020	30 cm	20
61201	fogantyú 130 cm	10



ÚTSZORÓ SÓ

R.sz.	leírás	
43300	10 kg	1
43301	25 kg	1



MENETES NYÉL



R.sz.	leírás	
61172	120 cm fa nákszlet	1
61192	150 cm fa nákszlet	for 52195 1
61193	150 cm fa nákszlet	for 52185 - 94 1
61194	140 cm fa nákszlet	1



NYÉL



R.sz.	leírás		R.sz.	leírás	
61171	1,2 m	1	61175	1,6 m	1
61173	1,4 m	1	61176	1,7 m	1
61174	1,5 m	1	61177	1,8 m	1

NYÉL



R.sz.	leírás	
52125	130 cm, finom szál	1
52126	130 cm, cérna	1



system click  
ON - OFF

NYÉL ALU



R.sz.	leírás	
45330	161 cm	24
45331	100 cm	24

LAPÁTNYÉL



R.sz.	leírás	
61200	130 cm	10



LAPÁTNYÉL



R.sz.	leírás	
61201	130 cm, egyenes	10



### ÁSÓNYÉL „T” FOGANTYÚ



R.sz.	leírás	
61208	90 cm	10



### „T” LAPÁTNYÉL



R.sz.	leírás	
61202	130 cm, egyenes	10



### LOMBSEPRŰ NYÉL



R.sz.	leírás	
61215	160 cm	10



### ÁSÓNYÉL „Y” FOGANTYÚ



R.sz.	leírás	
61207	100 cm	10



### CSÁKÁNY NYÉL



R.sz.	leírás	
61204	95 cm, szűk (for 61120)	10
61205	95 cm	10



### KAPA NYÉL



R.sz.	leírás	
61219	120 cm	10



### GEREBLYE NYÉL



R.sz.	leírás	
61195	120 cm	10

### GEREBLYE NYÉL



R.sz.	leírás	
61183	150 cm	10
61184	160 cm	10
61189	170 cm	10
61190	180 cm	10



### LOMBSEPRŰNYÉL



R.sz.	leírás	vhodné for	
61250	160 cm	45051, 61048	20
61251	160 cm	45052	20
61252	160 cm	45320	20
61253	160 cm	45053	20
61254	160 cm	45054	20
61255	160 cm	45070	20
61256	160 cm	45055	20



### „Y” FOGANTYÚ



R.sz.	leírás	
61230		10

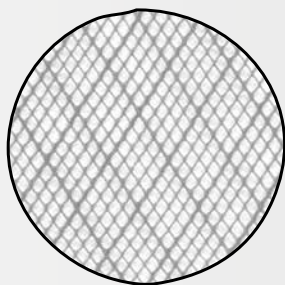

SZÚNYOGHÁLÓ - PE MŰANYAG

R.sz.	leírás	
40100	1 x 25 m - PE fehér	1
40120	1,2 x 25 m - PE fehér	1

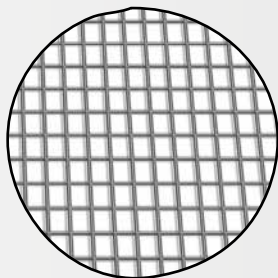

SZÚNYOGHÁLÓ

ALU Zn

R.sz.	leírás	
42101	1 x 30 m - ALUMINIUM	2
42103	1 x 30 m - horganyzott Ø huzal	2

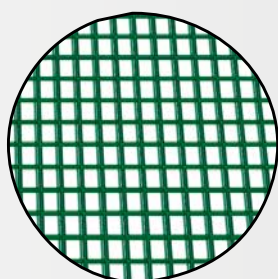

SZÚNYOGHÁLÓ FÉM FESTETT

R.sz.	leírás	
42102	1 x 30 m - Zöld bevonatú acélØ huzal	2

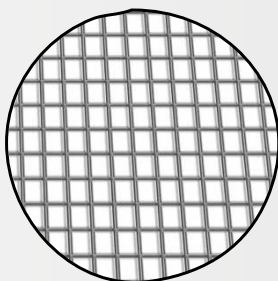

SZÚNYOGHÁLÓ - ÜVEGSZÁLAS

R.sz.	leírás	
41083	0,8 x 30 m fehér	6
41103	1 x 30 m fehér	6
41123	1,2 x 30 m fehér	6
41153	1,5 x 30 m fehér	6

R.sz.	leírás	
41082	0,8 x 30 m fehér-szürke	6
41102	1 x 30 m fehér-szürke	6
41122	1,2 x 30 m fehér-szürke	6
41152	1,5 x 30 m fehér-szürke	6

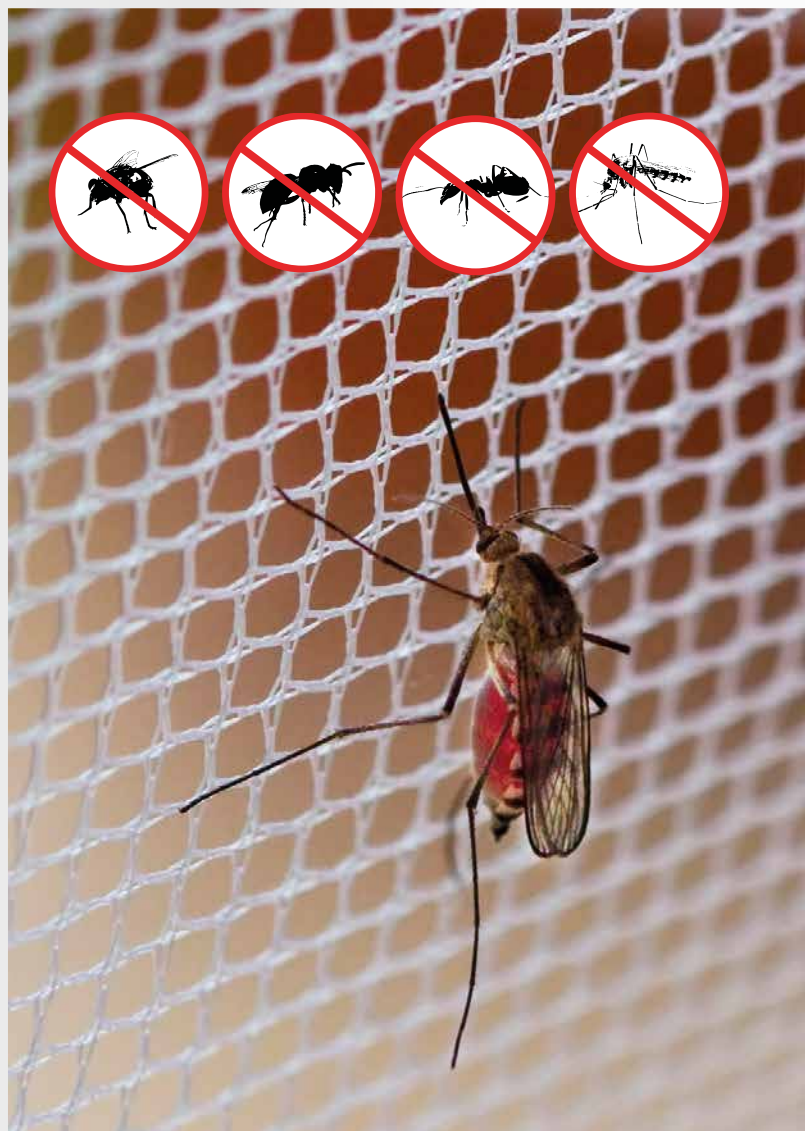

ROVAR KÉPERNYŐK

R.sz.	leírás	
41050	0,5 x 30 m szürke	6
41080	0,8 x 30 m szürke	6
41100	1 x 30 m szürke	6
41120	1,2 x 30 m szürke	6
41150	1,5 x 30 m szürke	6

R.sz.	leírás	
41081	0,8 x 30 m fekete	6
41101	1 x 30 m fekete	6
41121	1,2 x 30 m fekete	6
41151	1,5 x 30 m fekete	6

NEW

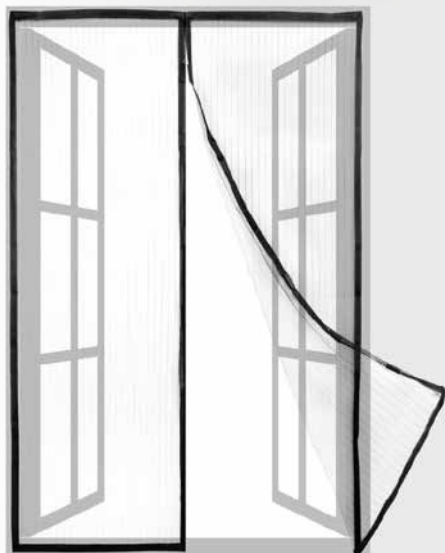

### SZÚNYOGHÁLÓ AJTÓRA, MÁGNESES, ANTRACIT



R.sz.	Leírás	1
40077	100 x 220 cm	1



### SZÚNYOGHÁLÓ 4 LAMELLÁS

változó méretű 60 - 120 cm

R.sz.	leírás	20
40075	4 x 35 x 220 cm fehér	20
40076	4 x 35 x 220 cm fekete	20



### SZÚNYOGHÁLÓ - FEHÉR



R.sz.	leírás	10
40050	150 x 130 cm 5,6 m	10
40052	150 x 180 cm 6,6 m	10
40054	150 x 90 cm 4,8 m	10
40056	220 x 75 cm 2 db 5,8 m	10



### SZÚNYOGHÁLÓ - SZÜRKE



R.sz.	leírás	10
40051	150 x 130 cm 5,6 m	10
40053	150 x 180 cm 6,6 m	10
40055	150 x 90 cm 4,8 m	10



### SZÚNYOGHÁLÓ - FEKETE



R.sz.	leírás	10
40057	150 x 130 cm 5,6 m	10
40058	150 x 180 cm 6,6 m	10
40059	150 x 90 cm 4,8 m	10



### TÉPŐZÁR

R.sz.	leírás	1
40060	9 mm   7 m	1

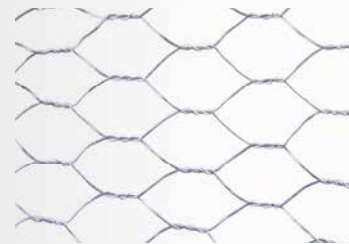

## DRÓTHÁLÓ HATSZÖG, ZINC

Zn

R.s.	leírás	
42150	13   0,7 x 1000 mm - 50 m	1
42151	16   0,7 x 1000 mm - 50 m	1
42152	20   0,7 x 1000 mm - 50 m	1
42153	25   0,8 x 1000 mm - 50 m	1

## DRÓTHÁLÓ HATSZÖG, ZINC

Zn

R.s.	leírás	
42155	13   0,7 x 1000 mm - 50 m	1
42156	16   0,7 x 1000 mm - 50 m	1
42157	20   0,7 x 1000 mm - 50 m	1
42158	25   0,8 x 1000 mm - 50 m	1

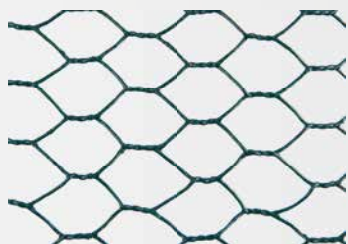

## DRÓTHÁLÓ HATSZÖG, MŰANYAG

Zn

R.s.	leírás	
42160	13   1 x 1000 mm - 25 m	1
42161	16   1 x 1000 mm - 25 m	1
42162	20   1 x 1000 mm - 25 m	1
42163	25   1 x 1000 mm - 25 m	1



## DÍSZ DRÓTKERÍTÉS PVC

R.s.	eye size	Ø huzal	wysokosc	length	
42175	15 x 9 mm	2 mm	40 cm	25 m	1
42176	15 x 9 mm	2 mm	65 cm	25 m	1
42177	15 x 9 mm	2 mm	90 cm	25 m	1
42178	15 x 9 mm	2 mm	120 cm	25 m	1
42179	15 x 9 mm	2 mm	25 cm	25 m	1

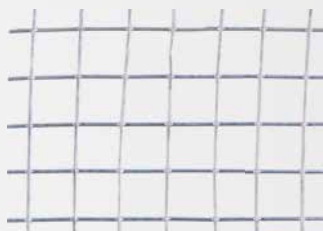

## DRÓTHÁLÓ NÉGYZET, ZINC

Zn

R.s.	leírás		R.s.	leírás	
42185	6   0,65 x 1000 mm - 25 m	1	42174	25   1,4 x 1000 mm - 25 m	1
42170	10   0,8 x 1000 mm - 25 m	1	42186	13   1,05 x 1000 mm - 25 m	1
42171	13   0,8 x 1000 mm - 25 m	1	42187	25   2,0 x 1000 mm - 25 m	1
42172	16   1,2 x 1000 mm - 25 m	1	42188	50   2,0 x 1000 mm - 25 m	1
42173	19   1,4 x 1000 mm - 25 m	1			



## KERÍTÉSFONAT, PVC BEVONAT, ZÖLD

R.s.	leírás	
42180	13   1,2 x 1000 mm - 25 m	1
42181	16   1,2 x 1000 mm - 25 m	1
42182	25   2,3 x 1000 mm - 25 m	1

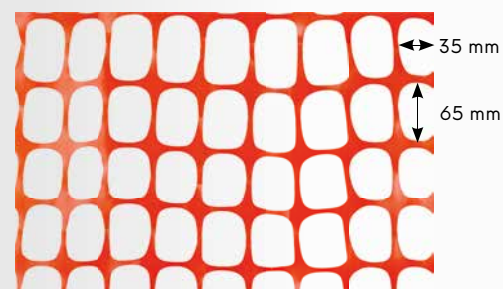

## CSIRKE HÁLÓ



R.s.	leírás	
45570	2 x 5 m 18 x 18 mm	45
45571	2 x 10 m 18 x 18 mm	28
45572	4 x 5 m 18 x 18 mm	24
45573	4 x 10 m 18 x 18 mm	15

## BIZTONSÁGI KERÍTÉS

R.s.	leírás	
42190	1,2 x 50 m HDPE 140g/m <sup>2</sup>	1



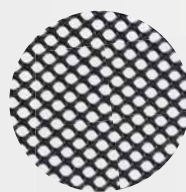

## DRÓTHÁLÓ RABIC



R.s.	leírás	
42312	1 m   50 bm, 16 x 16 mm	1

## FATÖRZS VÉDŐHÁLÓ

Önzáró



R.s.	leírás	
45580	Ø 11 x 80 cm	1



## KÖTÖZŐDRÓT

Zn

R.s.	Ø huzal	vezeték hossza	
42203	0,6 mm	30 m	50

## KÖTÖZŐDRÓT ZN

Zn

R.s.	Ø huzal	vezeték hossza	
42207	0,8 mm	50 m	40
42208	0,8 mm	100 m	20
42209	0,9 mm	100 m	20
42240	1,0 mm	50 m	40
42210	1,0 mm	100 m	20
42211	1,2 mm	50 m	40
42212	1,2 mm	100 m	20
42213	1,4 mm	30 m	40
42214	1,4 mm	50 m	20
42217	1,8 mm	30 m	40
42218	1,8 mm	50 m	20

## KÖTÖZŐDRÓT ZN

Zn

R.s.	Ø huzal	vezeték hossza	
42219	2,0 mm	26 m	20
42220	2,0 mm	52 m	20
42221	2,0 mm	78 m	20
42228	3,15 mm	26 m	10
42229	3,15 mm	52 m	10
42230	3,15 mm	78 m	10



## KÖTÖZŐDRÓT

R.s.	Ø huzal	vezeték hossza	powlekanie	
42201	0,6 mm	30 m	PVC	50
42202	0,9 mm	30 m	PVC	50

## KÖTÖZŐ PVC

R.s.	Ø huzal	vezeték hossza	
42244	1,4 mm	50 m	20
42248	1,8 mm	50 m	20
42249	2,0 mm	50 m	20

## KÖTÖZŐ PVC

R.s.	Ø huzal	vezeték hossza	
42251	2,6 mm	26 m	20
42252	2,6 mm	52 m	20
42253	2,6 mm	78 m	20
42255	3,4 mm	26 m	10
42256	3,4 mm	52 m	10
42257	3,4 mm	78 m	10





SZÖGESDRÓT ZN

Zn			
R.s.	Ø huzal	vezeték hossza	
42260	1,7 mm	50 m	1
42261	1,7 mm	100 m	1

DRÓTFESZÍTŐ, ROZSDAMENTES VÉG

INOX		
R.s.	leírás	MOQ 50
50040	zöld	50
50041	fekete	50

DRÓTFESZÍTŐ

10x		
R.s.	leírás	
50042		10



DRÓTFESZÍTŐ

Zn		
R.s.	leírás	
50030	vékony Zn bevonat	50
50032	vékony műanyag bevonat PVC	50

DRÓTFESZÍTŐ

Zn		
R.s.	leírás	
50031	masszív Zn bevonat	50
50033	masszív műanyag bevonat PVC	50



DRÓTFESZÍTŐ

Zn		
R.s.	leírás	
50037	vékony Zn bevonat	50
50038	vékony műanyag bevonat PVC	50

KÉZI CSÖRLŐ

R.s.	leírás	
50035	2 t	6
50036	4 t	4

NEW

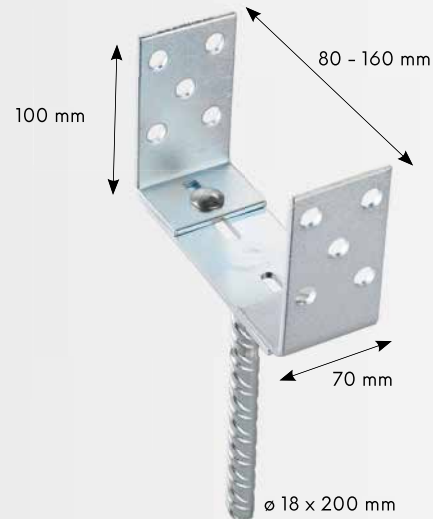

## OSZLOTARTÓ, ÁLLÍTHATÓ

Zn

R.sz.	Leírás	tl.		
55465	80 - 160 x 70 mm	100 mm	4 mm	1



Ø 18 x 200mm



Ø 18 x 200mm

## OSZLOPTARTÓ

Zn

R.sz.	leírás	tl.		
55436	70 x 75 mm	110 mm	4 mm	10
55437	80 x 90 mm	130 mm	4 mm	10

## OSZLOPTARTÓ

Zn

R.sz.	leírás	tl.		
55429	70 x 60 mm	100 mm	4 mm	10
55433	81 x 60 mm	100 mm	4 mm	10
55430	91 x 60 mm	100 mm	4 mm	10
55431	101 x 60 mm	100 mm	4 mm	10
55432	121 x 60 mm	100 mm	4 mm	10



## OSZLOPTALP ZN

Zn

R.sz.	Ø kotwica	dlugosc kotwica	grubosc materialu	
55400	71 x 71 mm	750 mm	2 mm	1
55401	91 x 91 mm	750 mm	2 mm	1
55406	81 x 81 mm	750 mm	2 mm	1
55402	91 x 91 mm	900 mm	2 mm	1
55403	101 x 101 mm	900 mm	2 mm	1
55404	121 x 121 mm	900 mm	2 mm	1
55405	151 x 151 mm	900 mm	2 mm	1



## OSZLOPTALP ZN

Zn

R.sz.	Ø kotwica	dlugosc kotwica	grubosc materialu	
55420	71 x 71 mm	150 mm	2 mm	1
55425	81 x 81 mm	150 mm	2 mm	1
55421	91 x 91 mm	150 mm	2 mm	1
55422	101 x 101 mm	150 mm	2 mm	1
55423	121 x 121 mm	150 mm	2 mm	1
55424	151 x 151 mm	150 mm	2 mm	1

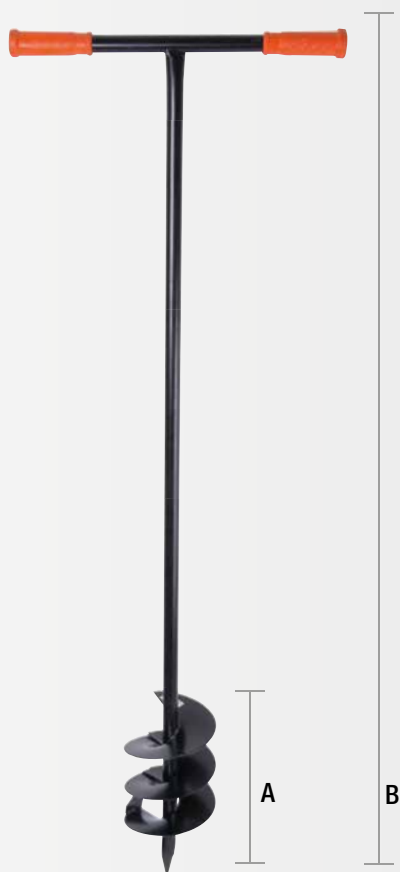

FÖLDFÚRÓ

R.s.	Ø	A	B	
61299	110 mm	270 mm	1200 mm	1
61300	140 mm	270 mm	1200 mm	1
61301	170 mm	270 mm	1200 mm	1
61302	200 mm	270 mm	1200 mm	1

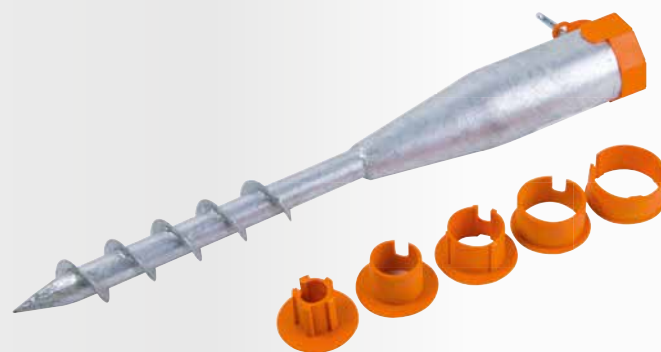

UNIVERZÁLIS NAPERNYŐ TARTÓ

csökkentés

- Ø 24 mm
- Ø 35 mm
- Ø 40 mm
- Ø 48 mm
- Ø 55 mm

Zn 6x

R.s.	Ø kotwica	długość kotwica	leírás	
55450	60 mm	550 mm	1 db + 5x csökkentés	8

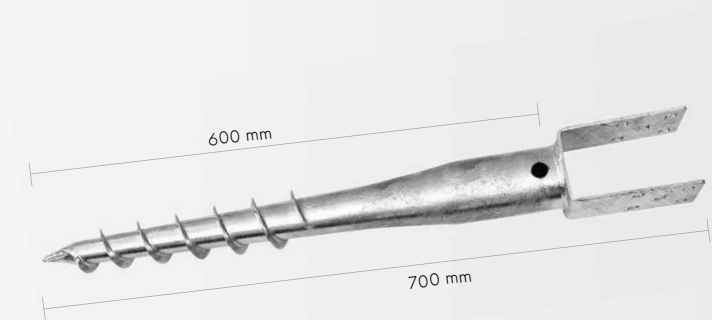

OSZLOPLEHORGANYZÓ CSAVAROS TŰSKE "U"

Zn

R.s.	Ø kotwica	długość kotwica	grubość materiału	
55455	71 x 60 mm	100 mm	4 mm	1
55452	81 x 60 mm	100 mm	4 mm	1
55456	90 x 60 mm	100 mm	4 mm	1
55453	101 x 60 mm	100 mm	4 mm	1
55457	110 x 60 mm	100 mm	4 mm	1
55454	121 x 60 mm	100 mm	4 mm	1



ÁLLÍTHATÓ OSZLOP TARTÓ TALP

Zn

R.s.	Ø kotwica	wysokość kotwica	wątek	
55460	80 x 80 mm	150 mm	M16	10
55461	100 x 100 mm	150 mm	M16	10
55462	150 x 150 mm	150 mm	M24	10

## BAMBUSZKERÍTÉSEK ÉS ÁRNYÉKOLÓ HÁLÓK

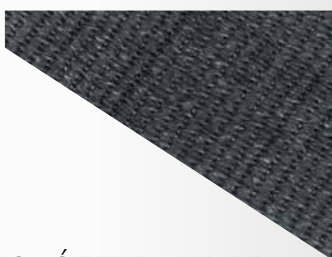

### ÁRNYÉKOLÓTEXTIL HDPE 150 G/ M<sup>2</sup> ANTRACIT

· árnyékolás 85%

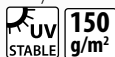

R.sz.	leírás	
45496	1 x 10 m	1
45497	1,5 x 10 m	1
45498	1,8 x 10 m	1
45499	2 x 10 m	1

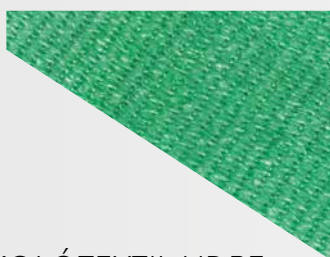

### ÁRNYÉKOLÓTEXTIL HDPE 150 G/ M<sup>2</sup>

· árnyékolás 85%

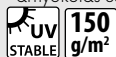

R.sz.	leírás	
45460	1 x 10 m	1
45461	1,5 x 10 m	1
45463	1,8 x 10 m	1
45462	2 x 10 m	1

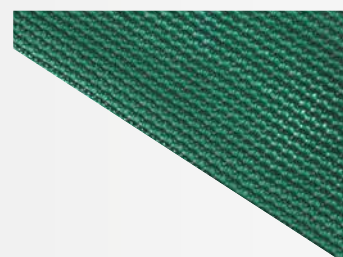

### ÁRNYÉKOLÓTEXTIL HDPE 220 G/ M<sup>2</sup>

· árnyékolás 95%

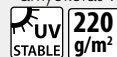

R.sz.	leírás	
45465	1 x 10 m	1
45466	1,5 x 10 m	1
45467	2 x 10 m	1

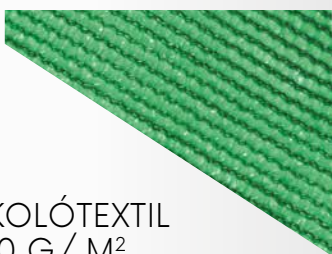

### ÁRNYÉKOLÓTEXTIL HDPE 80 G/ M<sup>2</sup>

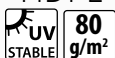

R.sz.	leírás	
45450	1 x 10 m	1
45451	1,5 x 10 m	1
45453	1,8 x 10 m	1
45452	2 x 10 m	1

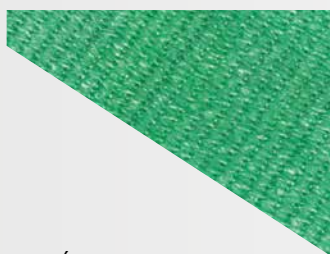

### ÁRNYÉKOLÓTEXTIL HDPE 150 G/ M<sup>2</sup>

· árnyékolás 85%



R.sz.	leírás	
45480	1,5 x 50 m	1

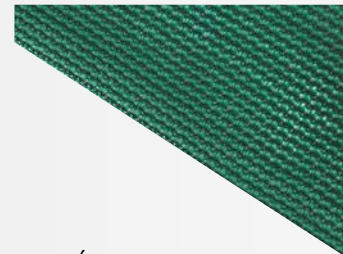

### ÁRNYÉKOLÓTEXTIL HDPE 220 G/ M<sup>2</sup>

· árnyékolás 95%



R.sz.	leírás	
45485	1,5 x 50 m	1

NEW



### KÁBELKÖTŐZŐ

· EN 50146  
· nylon

50x

R.sz.	leírás	
23875	120 mm 4,8 mm	1



### ÁRNYÉKOLÓ RÖGZÍTŐ

20x

R.sz.	leírás	
45470		1



GRILL



GRILLEZŐ KLT.

INOX 18x

R.s. leírás  
43077



6



GRILLEZŐ KLT.

INOX 3x

R.s. leírás  
43071 380 mm



16



GRILLEZŐ FOGÓ

INOX

R.s. leírás  
43072 360 mm



25



ALU GRILL TÁLCA

4x

R.s. leírás  
43050 300 x 200 mm

50

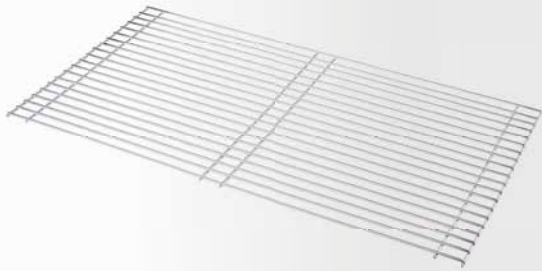

## GRILL RÁCS

R.sz.	leírás	
43058	58 x 30 mm	20
43060	60 x 40 mm	20
43068	68 x 40 mm	16

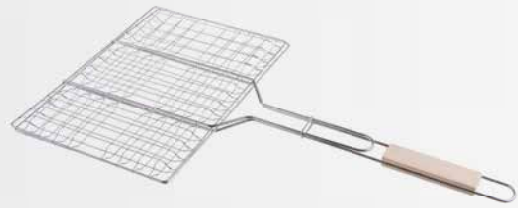

## HÚS GRILLEZŐ

R.sz.	leírás	
43084	330 x 290 mm	50

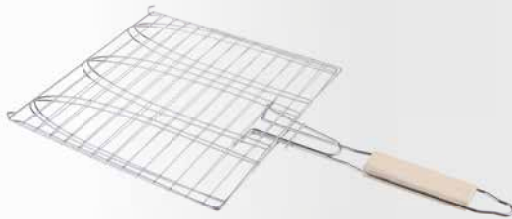

## HAL GRILLEZŐ

R.sz.	leírás	
43082	280 x 276 mm	50

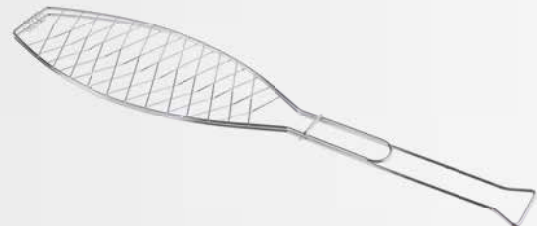

## HAL GRILLEZŐ

R.sz.	leírás	
43083	360 x 130 mm	12

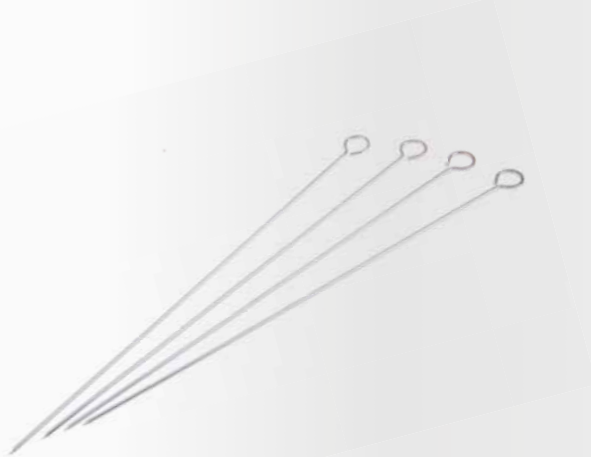

## SASLIK GRILL NYÁRS

R.sz.	leírás	
43086	Ø 3 x 380 mm	80



## VILLA

· higiéniai jóváagyással

R.sz.	leírás	
43097	100 cm	100



GRILL FORGATÓ MOTOR ELKTR. 230V



R.s. leírás  
43090



24



GRILL FORGATÓ MOTOR ELEMES



R.s. leírás  
43089

48



GRILLKAPARÓ

R.s. leírás  
43098 30 cm

10



GRILL TISZTÍTÓ KEFE

R.s. leírás  
43099

40



LÉGFUVÓ, MECH.

R.s. leírás  
43087



1



400

LAKATOK



404

POSTALÁDÁK,  
PÉNZES KAZETTÁK

406

SPANIFER,  
RAKOMÁNYRÖGZÍTŐK

409

KÖTÉL,  
RAGASZTÓ PISZTOLY

411

OLVASZTÓ PISZTOLY



413

ÜVEGTÁBLA FOGÓ





415

LEFOLYÓ TISZTÍTÓ



417

VASÁRUK



418

LÁMPÁK



421

PAPÍR KÍNÁLÓ ÁLLVÁNYOK



422

ÁLLVÁNYOK ÉS  
KONZOLOK SU-5



426

SZERSZÁMOK KUBALA

VASÁRUK

398 - 431



## ZÁRAK

**FESTA**SZÉF  
ELEKTRONIKUS ZÁRRAL

4x AA

- Zár típusa: elektronikus, mechanikus
- Biztonsági kulcs
- Méretek 350x250x250mm
- Súly 10 kg



R.s. leírás

23270

1

**FESTA**

## ZÁRBETÉT NIKKELEZETT

3x

R.s. leírás

23001 65 mm · 175 g



10

## ZÁRBETÉT NIKKELEL BEVONT

3x

R.s. leírás

23000 65 mm · 75 g



15



**FESTA**

LAKAT



R.s.	leírás		R.s.	leírás	
23261	25 mm	6	23264	45 mm	6
23262	32 mm	12	23265	52 mm	12
23263	38 mm	6	23266	63 mm	6

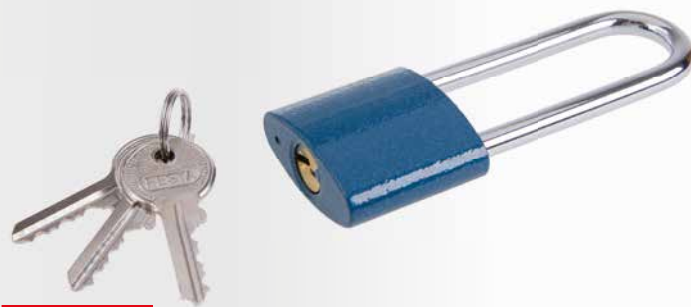

**FESTA**

LAKAT HOSSZÍTOTT



R.s.	leírás		R.s.	leírás	
23211	25 mm	12	23214	45 mm	6
23212	32 mm	12	23215	52 mm	6
23213	38 mm	6			



**FESTA**

SÁRGARÉZ FÜGGŐLAKAT  
MŰANYAGOZÁSSAL



R.s.	leírás	
23310	30 mm	10
23311	40 mm	10
23312	50 mm	6



**FESTA**

ERŐSÍTETT SÁRGARÉZ LAKAT



R.s.	leírás		R.s.	leírás	
23125	25 mm	12	23140	40 mm	12
23130	30 mm	12	23150	50 mm	12
23135	35 mm	12	23160	60 mm	12



**FESTA**

LAKAT



R.s.	leírás	
23274	60 mm	6
23275	70 mm	12



VAS LAKAT



R.s.	leírás		R.s.	leírás	
23220	25 mm	6	23240	40 mm	6
23225	30 mm	6	23250	50 mm	6
23232	32 mm	6	23260	60 mm	6



## SÁRGARÉZ LAKAT



R.s.	leírás		R.s.	leírás	
23020	20 mm	12	23040	40 mm	12
23025	25 mm	12	23050	50 mm	12
23030	30 mm	12	23060	60 mm	12
23035	35 mm	12			

## SÁRGARÉZ LAKAT



R.s.	leírás	
23070	40 mm	12



## LAKAT



R.s.	leírás	
23010	50 mm	6

## LAKAT VÍZBIZTOS



R.s.	leírás	
23005	40 mm	6
23006	50 mm	6

**FESTA**

## KERÉKPÁR LAKAT



R.s.	leírás	
23288	120 cm x Ø 10 mm	1

**FESTA**

## KERÉKPÁR LAKAT



R.s.	leírás	
23287	65 cm x Ø 10 mm	1



**FESTA**

**KEREKPÁR LAKAT**



R.sz.	leírás	
23290	120 cm x Ø 8 mm	1
23291	150 cm x Ø 8 mm	20
23292	180 cm x Ø 8 mm	1



**KEREKPÁR LAKAT**



R.sz.	leírás	
23297	180 cm x Ø 8 mm	25

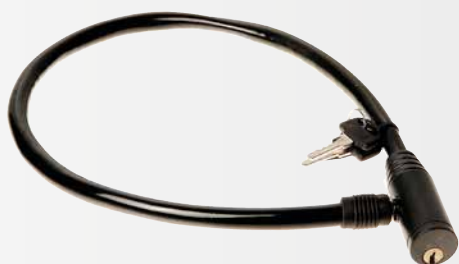

**KEREKPÁR LAKAT**



R.sz.	leírás	
23282	55 cm x Ø 8 mm	50
23284	65 cm x Ø 8 mm	50



**KEREKPÁR LAKAT**



R.sz.	leírás	
23281		20



**FESTA**

**KULCSJELZŐ**



R.sz.	leírás	
23391		50



**KULCSJELZŐ**



R.sz.	leírás	
23390		1



**CSUKLÓS LAKATPÁNT**

R.sz.	leírás	
51514	100 mm	25
51515	120 mm	25
51516	140 mm	25
51517	160 mm	25



**TOLÓZÁR**

R.sz.	leírás	
51510	100 mm	12
51511	120 mm	12
51512	140 mm	12
51513	160 mm	12



KÉSZPÉNZES DOBOZOK ÉS  
POSTAFIÓKOK



KULCSSZEKRÉNY



R.sz.	leírás	
70140	250 x 180 x 80 mm - 48 kulcs számára	12
70141	300 x 230 x 90 mm - 90 kulcs számára	8



KASSZA



R.sz.	width	deep	height	
70120	125 mm	95 mm	60 mm	1



KASSZA



R.sz.	width	deep	height	
70121	152 mm	118 mm	80 mm	36



KASSZA



R.sz.	width	deep	height	
70122	200 mm	160 mm	90 mm	20



KASSZA



R.sz.	width	deep	height	
70123	250 mm	180 mm	90 mm	16



KASSZA



R.sz.	width	deep	height	
70124	300 mm	240 mm	90 mm	10



KASSZA



R.sz.	width	deep	height	
70125	370 mm	280 mm	90 mm	8



POSTALÁDA



R.s.	color	width	deep	height	
70101	fehér	290 mm	360 mm	105 mm	5
70100	barna	290 mm	360 mm	105 mm	5

POSTALÁDA



R.s.	color	width	deep	height	
70102	fehér	310 mm	260 mm	90 mm	10
70103	barna	310 mm	260 mm	90 mm	10



POSTALÁDA



R.s.	color	width	height	deep	
70104	fehér	310 mm	360 mm	90 mm	6
70105	barna	310 mm	360 mm	90 mm	5

POSTALÁDA



R.s.	color	width	deep	height	
70108	fehér	370 mm	134 mm	364 mm	5



POSTALÁDA



R.s.	width	deep	height		
70107	inox	360 mm	100 mm	520 mm	6

POSTALÁDA



R.s.	width	deep	height		
70106	inox	360 mm	100 mm	360 mm	5



POSTALÁDA



R.s.	width	deep	height		
70109	inox	310 mm	90 mm	260 mm	6

POSTALÁDA



R.s.	width	deep	height		
70110	inox	310 mm	90 mm	360 mm	6



SPANIFER

**FESTA**

SPANIFER



2x

R.s.	width	length	load capacity	db	
51070	18 mm	2 m	100 kg	2	12



**FESTA**

SPANIFER



R.s.	width	length	load capacity	db	
51071	25 mm	3,5 m	300 kg	1	8



**FESTA**

SPANIFER



R.s.	width	length	load capacity	db	
51072	35 mm	4 m	500 kg	1	6



**FESTA**

SPANIFER



R.s.	width	length	load capacity	db	
51040	25 mm	6 m	1000 kg	1	1
51041	35 mm	8 m	2000 kg	1	1
51042	35 mm	8 m	3000 kg	1	1
51043	50 mm	10 m	5000 kg	1	1



**FESTA**

SPANIFER



R.s.	width	length	load capacity	db	
51060	25 mm	5 m	750 kg	2	5



**FESTA**

SPANIFER



R.s.	width	length	load capacity	db	
51065	50 mm	10 m	960 kg	1	6



**FESTA**

SPANIFER



R.s.	width	length	load capacity	db	
51026	75 mm	5 m	3000 kg	1	4



**NEW**

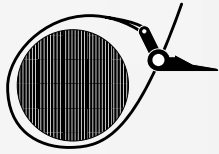

**FESTA**  
SPANIFER



R.s.	width	length	load capacity	db	
51032	25 mm	5 m	500 kg	1	6



**FESTA**  
SPANIFER



R.s.	width	length	load capacity	db	
51017	50 mm	6 m	480 kg	2	5
51018	50 mm	6 m	480 kg	1	10



SPANIFER

R.s.	width	length	leírás	
51022	25 mm	5 m	horgokkal	40
51023	50 mm	5 m	horgokkal	12



**FESTA**  
SPANIFER

**PE**

Puha EVA pad

R.s.	width	length	db	
51046	38 mm	4 m	1	20



SPANIFER

R.s.	width	length	leírás	
51030	50 mm	6 m	horgokkal	20
51034	50 mm	8 m	horgokkal	10



SPANIFER

**2x**

R.s.	width	length	db	
51020	25 mm	2,5 m	2	100



SPANIFER

**PE**

R.s.	width	length	db	
51045	25 mm	4 m	1	50



RAKOMÁNYRÖGZÍTŐ ÁLLÍTHATÓ

**2x**

R.s.	length	Ø	db	
51013	1,2 m	8 mm	2	1





## RAKOMÁNYRÖGZÍTŐ

2x

R.s.	length	db	
51008	1 m	2	25



## RAKOMÁNYRÖGZÍTŐ



R.s.	length	∅	db	
51009	1 m	10 mm	1	25



## GUMIPÓK KLT.

8x

- 2 x 0,4 m
- 2 x 0,6 m
- 1 x 0,8 m
- 1 x 1,0 m

R.s.	length	∅	db	
51011	1 m	8 mm	8	10



## GUMIPÓK

2x

R.s.	length	∅	db	
51001	80 cm	10 mm	2	50
51002	100 cm	10 mm	2	50
51003	150 cm	10 mm	2	50
51004	200 cm	10 mm	2	50



## GUMIPÓK

2x

R.s.	length	∅	db	
51007	1 m	8 mm	2	25



## GUMIPÓK

R.s.	length	∅	leírás	
51010	80 cm	8 mm	8 ágú	50



## GUMI HÁLÓ

R.s.	length	width	
51015	80 cm	120 cm	20



## GUMIKÖTÉL



R.s.	length	∅	
51036	20 m	8 mm	10
51037	20 m	10 mm	6





## GUMIPÓK KAMPÓ

20x

R.s.	length	
51038	8 mm	30



## ALUMÍNIUM KARABINER

ALU

MOQ  
2

R.s.	∅	length	
51187	5 mm	50 mm	2
51200	6 mm	60 mm	2
51202	7 mm	70 mm	2



## ZSINÓR PE.

R.s.	length	∅	
51055	80 m	1,5 mm	50
51056	50 m	2 mm	50
51057	20 m	4 mm	50



## MÜANYAGZSINEG

R.s.	tömeg	
50905	80 g	80
50906	100 g	100
50907	200 g	50



## KENDERZSINEG

R.s.	tömeg	
50900	80 g (61 m)	1
50901	100 g (76 m)	1
50902	200 g (153 m)	1



## KÖTÉL



R.s.	length	∅	
50915	5 m	8 mm	1
50916	25 m	8 mm	1
50917	25 m	10 mm	1
50918	25 m	12 mm	1
50919	25 m	14 mm	1



## KÖTÉL PE.

R.s.	length	∅	
51050	50 m	8 mm	10
51051	50 m	10 mm	4



## MÜANYAGZSINEG

R.s.	tömeg	
50909	500 g (250 m)	1
50910	1000 g (500 m)	1
50911	5000 g (2500 m)	1



## VIASZOLT ZSINEG



R.s.	length	∅	
50920	50 m	1 mm	80

NEW



## KÁBELKÖTŐZŐ

· EN 50146  
· nylon

50x

R.sz.	leírás		
23875	120 mm	4,8 mm	1



## KÁBELKÖTŐZŐ, SZÍNES

100x

· EN 50146  
· nylon

R.sz.	length	width	
23880	100 mm	2,5 mm	1
23882	150 mm	2,5 mm	1
23884	200 mm	3,6 mm	1



Ø 15 - 32 mm

## KÁBELKÖTŐZŐ OLDHATÓ

10x

UV  
STABLE

R.sz.	length	width	
23865	160 mm	7,5 mm	1



## KÁBELKÖTŐZŐ

50x

· EN 50146  
· nylon

R.sz.	length	width	
23850	120 mm	2,5 mm	1
23854	200 mm	3,6 mm	1
23856	250 mm	3,6 mm	1
23858	250 mm	4,8 mm	1
23860	300 mm	4,8 mm	1
23864	400 mm	4,8 mm	1
23866	500 mm	4,8 mm	1
23868	400 mm	7,6 mm	1
23870	500 mm	7,6 mm	1



FESTA

## TÉPŐZÁRAS SZALAG 3DB

3x

R.sz.	width	length	
37295	20 mm	150 mm	1
37296	20 mm	200 mm	1
37297	20 mm	250 mm	1



## KÁBELKÖTŐZŐ

50x

· EN 50146  
· nylon

R.sz.	length	width	
23810	120 mm	2,5 mm	1
23814	200 mm	3,6 mm	1
23816	250 mm	3,6 mm	1
23818	250 mm	4,8 mm	1
23820	300 mm	4,8 mm	1
23824	400 mm	4,8 mm	1
23826	500 mm	4,8 mm	1
23828	400 mm	7,6 mm	1
23830	500 mm	7,6 mm	1



## TÉPŐZÁRAS SZALAG

R.sz.	leírás	
45471	12 mm x 5 m	1





**FESTA**

**RAGASZTÓ PISZTOLY - VEZETÉK NÉLKÜLI**



R.sz.	leírás		
89975	80 W   230 V	Ø ragasztó 11,2 mm	20



**RAGASZTÓ PISZTOLY**



R.sz.	leírás		
89973	60 W   230 V	Ø ragasztó 11,2 mm	20



**RAGASZTÓ PISZTOLY**



R.sz.	leírás		
89970	15 W   230 V	Ø ragasztó 7,2 mm	25



**RAGASZTÓ RÚD, TRANSPARENTS**

R.sz.	Ø	length	db	
89985	11,2 mm	200 mm	10	50
89987	11,2 mm	200 mm	1 kg	25



**RAGASZTÓ RÚD, TRANSPARENTS**

R.sz.	Ø	length	db	
89980	7,2 mm	100 mm	12	100
89988	7,2 mm	100 mm	1 kg	25



**RAGASZTÓ RÚD, SZÍNES**

R.sz.	Ø	length	počet db v balení	
89990	11,2 mm	200 mm	10	50



**RAGASZTÓ RÚD, SZÍNES**

R.sz.	Ø	length	db	
89989	7,2 mm	100 mm	12	100

**FESTA****HŐLÉGFÚVÓ**

feszültség	230V   50Hz
energiafelhasználás	2000W
kapcsoló pozíciója	0 - I (350°C) - II (600°C)
kiegészítők	zsdamentes kiterjesztések / - 4 db



R.sz.	leírás
35320	2000 W

5

**FESTA****HŐLÉGFÚVÓ HŐMÉRSÉKLET SZABÁLYZÓVAL**

feszültség	230V   50Hz
energiafelhasználás	2000W
kapcsoló pozíciója	0 - I (50°C) - II (50 - 600°C)
levegőáramlás	250 - 500 l/min.
kiegészítők	zsdamentes kiterjesztések / - 4 db
	· digitális kijelző



R.sz.	leírás
35322	2000 W

5

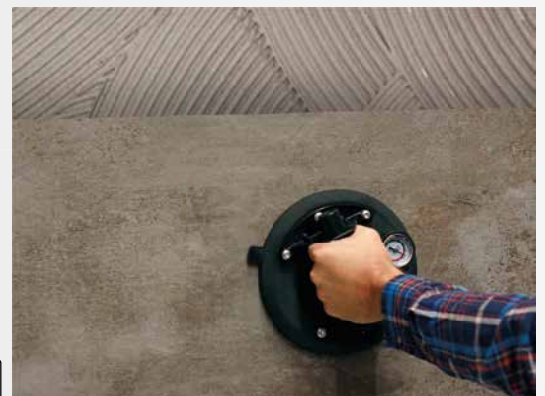
**NEW****FESTA****VÁKUMOS SZÍVÓKORONG**

durva és strukturált felületek

R.sz.	leírás
36325	max. 220 kg



1



**FESTA**

**ÜVEGTÁBLA FOGÓ**

pozíció	max. Betöltés
vízszintes helyzetben	50 kg
függőleges helyzet	50 kg

**ALU**

R.sz. leírás  
**36314** single



20

**ÜVEGTÁBLA FOGÓ**

R.sz. leírás  
**36305** single



60



**FESTA**

**ÜVEGTÁBLA FOGÓ**

pozíció	max. Betöltés
vízszintes helyzetben	80 kg
függőleges helyzet	100 kg

**ALU**

R.sz. leírás  
**36313** double



20

**ÜVEGTÁBLA FOGÓ**

R.sz. leírás  
**36306** double



20



**FESTA**

**ÜVEGTÁBLA FOGÓ**

pozíció	max. Betöltés
vízszintes helyzetben	120 kg
függőleges helyzet	150 kg

**ALU**

R.sz. leírás  
**36318** triple



10

**ÜVEGTÁBLA FOGÓ**

pozíció	max. Betöltés
vízszintes helyzetben	80 kg
függőleges helyzet	100 kg

R.sz. leírás  
**36319** triple



10



## RUGÓSMÉRLEG

R.s.	max.
24260	50 kg



10

## RUGÓSMÉRLEG

R.s.	max.	csomagolás
24212	12,5 kg	48
24225	25 kg	6
24250	50 kg	6
24255	100 kg	6
24258	150 kg	6



## CSIPESZ LEDFÉNNYEL



R.s.	leírás
50005	95 mm



8



## CSIPESZ KLT.



R.s.	leírás
50004	



1

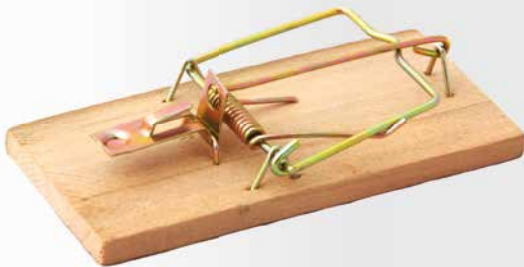

## EGÉRFOGÓ

2x

R.s.	leírás
70221	90 x 45 mm fa



1



## EGÉRFOGÓ

2x

R.s.	leírás
70220	97 x 47 mm műanyag



48

NEW

KÉZI LÉGTELENÍTŐ  
KULCS TARTÁLYOS

R.s.	Leírás
17459	50 ml

1





Ø 15 mm

### LEFOLYÓ TISZTÍTÓ

fúróval történő használat lehetősége

R.sz.	length	Ø
50014	6 m	6 mm



6



Ø 5mm

Ø 10mm

Ø 20mm

### LEFOLYÓ TISZTÍTÓ

### LEFOLYÓ TISZTÍTÓ

R.sz.	length	Ø
50009	3 m	5 mm



40

R.sz.	length	Ø
50010	3 m	10
50011	5 m	5
50012	10 m	3
50013	15 m	4



### LEFOLYÓ-TISZTÍTÓ PUMPA

R.sz.	length	Ø
50015	385 mm	65 mm



30

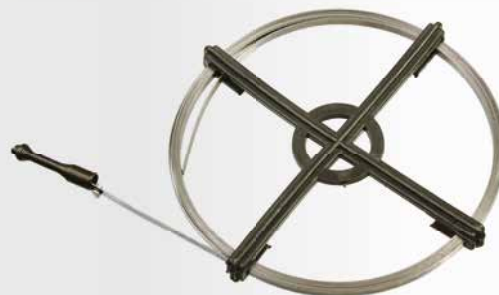

### BEHÚZÓSZALAG

R.sz.	length	Ø
51181	8 m	5 mm
51182	10 m	5 mm



25

25

**NEW**

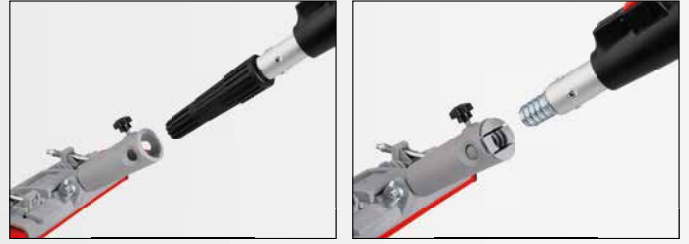

**FESTA**

**TELESZKÓPOS RÚD**

csavar 31610, 34203

R.sz.	Leírás	
52011	88 - 140 cm	1



**TELESZKÓPOS RÚD**

**ALU**

R.sz.	length		
52010	120 cm	ALU	50
52012	240 cm	ALU	25



**TELESZKÓPOS RÚD**

R.sz.	length		
52020	300 cm	ocel	10



**TELESZKÓPOS RÚD**

R.sz.	length		
52030	240 cm	fiberglass	6

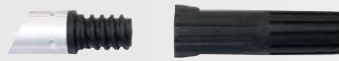

**SZEMÉTFELSZEDŐ**

forgó 90°

R.sz.	length	
61235	81 cm	12

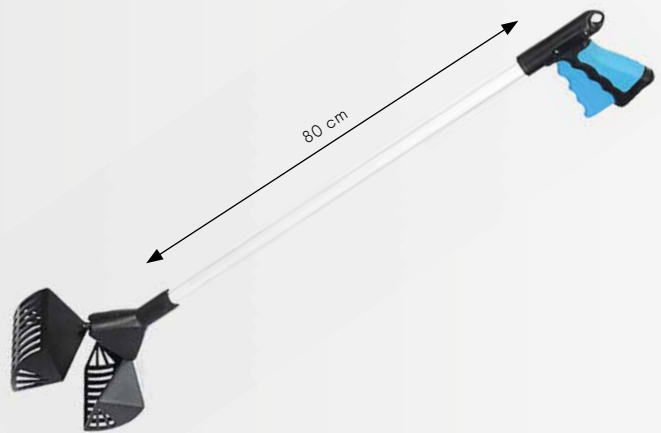

**SZEMÉTFELSZEDŐ**

max. 4 kg

R.sz.		
61236		12



**OLAJZÓKANNA**

R.s.	leírás	
50020	300 ml	10

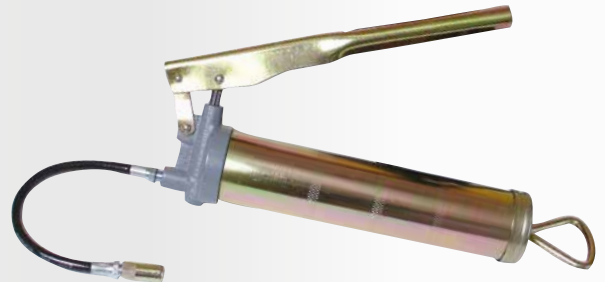

**KAROS ZSÍRZÓ**

- tölthető nagy mennyiségben vásárolt anyaggal
- patronos töltés
- tölthetőség adagolóval

R.s.	leírás	
50022	400 ml	20



**HORDÓPUMPA**

R.s.	leírás	
50017		10



**OLAJZÓ**

R.s.	leírás	
50019	90 ml	1



**SZÜRŐ LESZEDŐ**

R.s.	leírás	
50021	60 x 140 mm	6



**TÖLCSÉR**

R.s.	leírás	
50025	60 x 140 mm	50



**ÜZEMANYAGCSŐ SZELEPPEL**

R.s.	length	∅	
50026	180 cm	15 mm	24

## LAMPS AND LIGHTS



· mágnesek acél ajtókerethez való ragasztáshoz és így.



**FESTA**

## LED LÁMPA



MOQ  
12

R.s. leírás  
37645 200 mm 3 x AAA

12

**FESTA**

## FEJLÁMPA, LEDES

súly	42 g
fényforrás	1 x 1 W white LED + 2x red LED
akkumulátor	3 x AAA
méret	40 x 59 x 32 mm
a megvilágítás ideje	45 h
nyílás	120 lumen
a fény hossza	60 m (100% battery)
program száma	4



· 5 pozíciók



R.s. leírás  
37641 2 Kétféle fény, fehér és piros

1

**FESTA**

## FEJLÁMPA, LEDES



R.s. leírás  
37640 120 lumen + piros fény



6



**FESTA**

LED LÁMPA

LED light 3x AA

R.s.

37650

12



**FESTA**

LED LÁMPA

ALU LED light 2xAA 80 lumen

R.s.

leírás

37630

185 mm

2 x AA

20

LÁMPA 3 LEDDEL

kibocsátás	0,6 W
színhőmérséklet	700k
akkumulátor	2xD
súly	138g
a fény hossza	30 m
nyílás	50 lm



ALU LED light 2xAA 80 lumen

R.s.

leírás

37621

185 mm

6



## KONZOL FEHÉR

 MOQ  
2

R.sz.	leírás	
81100	100 x 75 mm	24
81101	125 x 100 mm	24
81102	150 x 125 mm	24
81103	200 x 150 mm	24
81104	250 x 200 mm	24
81105	300 x 250 mm	24
81106	350 x 300 mm	24



## POLCTARTÓ, EGYSZERŰ

R.sz.	leírás	
81053	50 cm	10
81054	80 cm	10
81056	150 cm	10
81057	200 cm	10



## REGÁL KAMPÓ

R.sz.	leírás	
81070	10 cm	10
81071	15 cm	10
81072	20 cm	10
81074	30 cm	10
81075	35 cm	10
81077	50 cm	10



PAPÍR KÍNÁLÓ ÁLLVÁNY FESTA SZERSZÁMOK

R.s. leírás  
81602 60 x 40 x 175 cm - ENG



PAPÍR KÍNÁLÓ ÁLLVÁNY FESTA KISGÉPEK

R.s. leírás  
81603 60 x 40 x 175 cm



PAPÍR KÍNÁLÓ ÁLLVÁNY SZINTEZŐ RENDSZER

R.s. leírás  
37179 60 x 40 x 175 cm - ENG



## ÁLLVÁNYOK ÉS KONZOLOK SU-5



A SZÜKSÉGES POLC RENDSZER  
ÖSSZEÁLLÍTÁSÁHOZ KERESSE KOLLEGÁNKAT



## BEMUTATÓ ÁLLVÁNY FESTA

R.s.	leírás		
81011	állvány FESTA CZ	200 x 100 cm	1
81011A	állvány 81011 + matrica AQUATIC		1
81011F	állvány 81011 + matrica FESTA CZ		1
81011G	állvány 81011 + matrica FESTA GB		1
81011H	állvány 81011 + matrica FESTA SK		1
81011R	állvány 81011 + matrica ROSA		1
81012	polc fehér CZ	mélység 40	8
81013	horog 10 cm		10
81014	horog 16 cm		10
81015	horog 20 cm		10
81035	horog 20 cm		10
81016	horog 30 cm		10
81036	horog 30 cm		10
81022	drótkosár - nagy		1
81023	drótkosár - kicsi		1
81024	partíció - nagy		1
81025	partíció - kicsi		1





ÁLLVÁNYOK ÉS KONZOLOK SU-5



A REQUIRED POLC ASSEMBLY SZOLGÁLTATÁSÁT IS ELÉRHETŐSÉGEKET TUDOMÁNYOLNI

R.s.	leírás	
81200	Handstand 40/2400 mm anchored	1
81201	Handstand 80/1108 mm	1
81202	Handstand 80/1208 mm	1
81203	Handstand 80/1408 mm	1
81204	Handstand 80/1608 mm	1
81205	Handstand 80/1808 mm	1
81206	Handstand 80/2000 mm	1
81207	Handstand 80/2108 mm	1
81208	Handstand 80/2208 mm	1
81209	Handstand 80/2308 mm	1
81210	Handstand 80/2408 mm	1
81211	Handstand 80/2600 mm	1
81212	Handstand 60/1000 mm	1
81213	Handstand 60/1208 mm	1
81214	Handstand 60/1408 mm	1
81215	Handstand 60/1608 mm	1
81216	Handstand 60/1808 mm	1
81217	Handstand 60/2108 mm	1
81218	Handstand 60/2208 mm	1
81225	Handstand 30/2108 mm front	1
81486	Handstand 60/2000 mm	1
81219	Adapter of handstand 80x30/100mm	1
81220	Adapter of handstand 80x30/400 mm	1
81221	Adapter of handstand 80x30/600 mm	1
81222	Adapter of handstand 60x30/400 mm	1
81223	Corner handstand 90° 2100mm	1
81224	Corner handstand 90° 2200mm	1
81226	Support 80	1
81227	Support 60	1
81228	Clutch gondolas with a shelf 80	1
81229	Anchor bar	1
81230	Anchor hook	1
81231	Anchoring light	1
81232	Anchoring top	1
81233	Filling 400	1
81234	Filling 500	1
81235	Filling 600	1
81236	Filling 700	1
81237	Filling 800	1
81238	Console low 200	1
81239	Console low 300	1
81240	Console low 400	1
81241	Console low 500	1
81242	Console high 400	1
81243	Console high 500	1
81244	Console high 600	1
81245	Console high 700	1
81246	Console low 300 double	1
81247	Console low 400 double	1
81248	Console low 300 double	1
81251	Console RR 80	1
81249	Console high double 500	1
81250	Beam showcase 400/2000	1
81252	Hyphen trough shelves	1
81253	Hyphen low 300	1
81254	Hyphen low 400	1
81255	Hyphen low 500	1
81256	Hyphen low 300 glass	1
81257	Hyphen low 400 glass	1
81258	Hyphen low 500 glass	1
81259	Hyphen high 300 glass	1
81262	Hyphen high 300 plexi	1
81263	Hyphen high 400 plexi	1
81264	Hyphen high 500 plexi	1
81260	Hyphen high 400 glass	1
81261	Hyphen high 500 glass	1
81265	Side of showcase 400/2000	1
81266	Sidewall roofing RR 80	1
81267	Sidewall tray 500mm	1
81268	Sidewall showcase 500	1
81269	Beam showcase 500	1
81271	Sidewall shelves low 300 plastic	1
81272	Sidewall shelves low 400 plastic	1
81273	Sidewall shelves low 500 plastic	1
81274	Sidewall high glass 300/250	1
81275	Safety fuse	1
81276	Sidewall high glass 500/250	1
81277	Sidewall shelves high 400	1
81278	Sidewall shelves high 500	1
81270	Beam roofing RR 80	1
81279	Beam roofing	1
81280	Sidewall roofing left	1
81281	Sidewall roofing right	1
81282	Suspension arm	1
81284	Double shoulder 400/10	1
81285	Double shoulder 300/8	1
81286	Simple shoulder 350	1
81287	Simple shoulder 500	1
81288	Simple shoulder 250	1
81289	Double hinge 100	1
81290	Double hinge 200	1
81291	Double hinge 300	1
81292	Hinge 130 V	1

R.s.	leírás	
81293	Simple hinge 100	1
81294	Simple hinge 200	1
81295	Simple hinge 300	1
81296	Hook with horizontal bar 200	1
81297	Hook with horizontal bar 300	1
81298	Lock showcase	1
81299	Hyphen wire 360mm high	1
81300	Hyphen wire 460 mm high	1
81301	Hyphen wire 560 mm high	1
81302	Hyphen wire 560 mm nízke	1
81303	Bracket 300 double L	1
81304	Bracket 300 double P	1
81305	Bracket 400 double L	1
81306	Bracket 400 double P	1
81307	Bracket 500 double L	1
81308	Bracket 500 double P	1
81309	Shelf semicircle 300	1
81310	Shelf semicircle 400	1
81311	Shelf semicircle 500	1
81312	Sokl pülkrhu 500	1
81313	Forehead base semicircle 500	1
81314	Bracket 300 price tag semicircle	1
81315	Bracket 400 price tag semicircle	1
81316	Bracket 500 price tag semicircle	1
81317	Shelf semicircle 600	1
81318	Plinth semicircle 600	1
81319	Forehead base semicircle 600	1
81320	Price tag P 7,5x5 cm	1
81321	Price tag P 2,6x3,2 cm	1
81322	Price tag P 5,0x4,0 cm	1
81323	Perforated shelf 500/1000	1
81324	Connector upright 80, Module 1	1
81325	Rear panel 10x100cm	1
81326	Rear panel 20x100cm	1
81327	Rear panel 40x100cm	1
81328	Perforated rear panel 20x100 cm EUR	1
81329	Perforated rear panel 40x100 cm EUR	1
81330	Cover gondolas 8x100cm	1
81331	Cover gondolas 6x100cm	1
81332	Beam hinges 100cm	1
81333	Glass shelf 985/300 vitrine	1
81334	Glass shelf 985/400 vitrine	1
81335	Wooden shelf 47/98,5	1
81336	Wire shelf 1000/500	1
81337	Troughed shelf 1000x500	1
81338	Shelf 200/1000	1
81339	Shelf 300/1000	1
81340	Shelf 400/1000	1
81341	Shelf 500/1000	1
81342	Shelf 400/1000 RAL7015	1
81343	Shelf 500/1000 RAL7015	1
81347	High frame showcases 1000/400	1
81348	Glass frame high showcases 1000/400	1
81349	Female insert shelf	1
81350	Suspended ceiling metal shelves 500/100	1
81352	Front support high glass 1000 mm	1
81353	Front support high plexi	1
81354	Front support low plastic 1000 mm	1
81355	Price bar, 1000mm	1
81356	Comb socket rack	1
81351	Comb for high dividers, 1000	1
81357	Comb, 1000 mm	1
81403	Comb for high dividers, 1250 mm	1
81420	Comb for high dividers, 625 mm	1
81358	Double-groove door showcases	1
81359	Price tag holder, 1000mm	1
81360	Door showcases 1000/2000	1
81361	Forehead roofing, 1000mm	1
81362	Tile roofing, 1000mm	1
81363	Tray door	1
81364	Sliding door showcases	1
81365	Mirror showcases	1
81366	Hinge frame, module 1	1
81367	Curtain rod	1
81370	Trash wire oblique	1
81371	Tour 1000mm full plate	1
81372	Skirting the counter SU 5 1000mm	1
81373	Counter glassed 1000mm	1
81374	Counter with stainless steel plate 1000mm	1
81375	Counter with full plate 600mm	1
81376	Shelf counter 600mm	1
81377	Counter glassed 600mm	1
81378	Shelf counter 1000mm	1
81379	Long shelf counter	1
81380	Segment counter high 90°	1
81381	Double-groove counter 1000mm, couple	1
81382	Sliding doors counter 1000mm, couple	1
81383	Drawer board	1
81384	Wire shelf RDE 1000/360mm	1
81385	Wire shelf RDE 1000/460mm	1
81386	Wire shelf RDE 1000/560mm	1
81387	Price bar RDE 1000 mm	1
81388	Rear panel 100/1250mm full	1

R.s.	leírás	
81389	Rear panel 200/1250mm full	1
81390	Rear panel 400/1250mm full	1
81391	Rear panel 200/1250mm perforated	1
81393	Cover gondolas 80/1250mm	1
81392	Rear panel 400/1250mm perforated	1
81394	Cover gondolas 60/1250mm	1
81395	Beam hinges 1250mm	1
81396	Shelf 200/1250mm	1
81439	Beam hinges 1000 mm	1
81344	Shelf 300/1000 releírásrce	1
81345	Shelf 400/1000 releírásrce	1
81346	Shelf 500/1000 releírásrce	1
81397	Shelf 300/1250mm	1
81400	Shelf 300/1250mm, releírásrce	1
81401	Shelf 400/1250mm, releírásrce	1
81402	Shelf 500/1250mm, releírásrce	1
81398	Shelf 400/1250mm	1
81399	Shelf 500/1250mm	1
81404	Front fulcrum low 1250mm, white plastic	1
81405	Price bar, 1250mm	1
81406	Comb 1250mm	1
81407	Price tag holder, 1250mm	1
81408	Forehead roofing, 1250mm	1
81409	Tile roofing, 600x1250mm	1
81410	Rear panel 100/625 full	1
81411	Rear panel 200/625 full	1
81412	Rear panel 400/625 full	1
81413	Rear panel 100/625 perforated	1
81414	Cover gondolas 80/650	1
81415	Cover gondolas 60/650	1
81416	Beam hinges, module 3	1
81432	Beam hinges, 1330mm	1
81417	Shelf 300/625	1
81418	Shelf 400/625	1
81419	Shelf 500/625	1
81421	Front support low 625, white plastic	1
81422	Price bar 625mm	1
81423	Comb 625mm	1
81424	Price tag holder, 625mm	1
81425	Rear panel 100/1330 full	1
81457	Molded plastic abtment low 200	1
81426	Rear panel 200/1330 full	1
81427	Rear panel 400/1330 full	1
81428	Rear panel 200/1330 perforated S	1
81429	Rear panel 400/1330 perforated S	1
81430	Cover gondolas 80/1330	1
81431	Cover gondolas 60/1330	1
81433	Shelf 300/1330	1
81434	Shelf 400/1330	1
81435	Shelf 500/1330	1
81436	Price bar, 1330 mm	1
81437	Comb 1330 mm	1
81438	Price tag holder 1330 mm	1
81440	Wire shelf - basket	1
81441	Rear panel 100 fillet	1
81442	Rear panel 400 fillet	1
81443	Forehead plinth fillet 500/1000mm	1
81444	Forehead plinth fillet 600 mm	1
81445	Rear panel fillet 400mm perforated	1
81447	Shelf 300 fillet	1
81448	Shelf 400 fillet	1
81449	Shelf 500 fillet	1
81450	Shelf 600 fillet	1
81451	Price tag holder 300 fillet	1
81452	Price tag holder 400 fillet	1
81453	Price tag holder 500 fillet	1
81454	Price bar 300 fillet	1
81455	Price bar 400 fillet	1
81456	Price bar 500 fillet	1
81458	Wire shelf basket U 1000/400	1
81459	Wire shelf basket U 1000/500	1
81460	Corner forehead plinth 90°	1
81461	Rear corner panel 100, stand 60	1
81462	Rear corner panel 200, stand 60	1
81463	Rear corner panel 400, stand 80	1
81466	Rear corner panel 100, stand 80	1
81467	Rear corner panel 400, stand 60	1
81468	Police corner 90° 400mm	1
81469	Police corner 90° 500mm	1
81470	Price tag holder corner 90° 400mm	1
81471	Price tag holder corner 90° 500mm	1
81472	Price bar fillet 90° 400mm	1
81473	Price bar fillet 90° 500mm	1

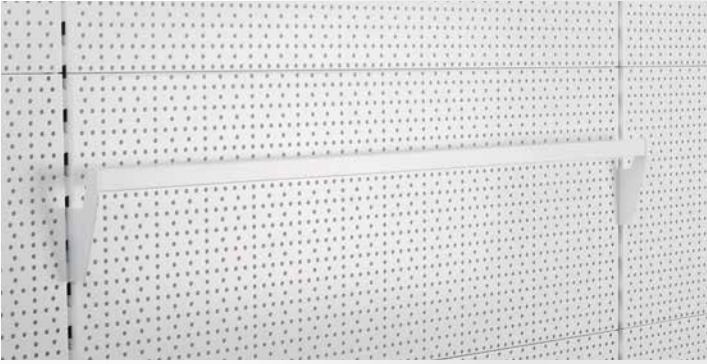

### TARTÓ KONZOL

FESTA állványhoz kompatibilis

R.sz.	leírás	
81150	1000 × 50 × 135 mm	1

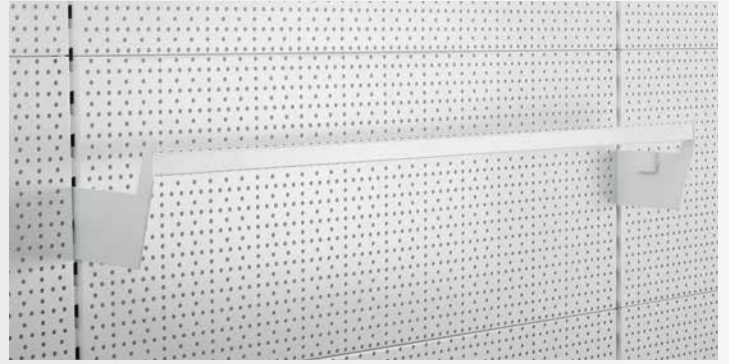

### TARTÓ KONZOL

FESTA állványhoz kompatibilis

R.sz.	leírás	
81151	1000 × 150 × 135 mm	1

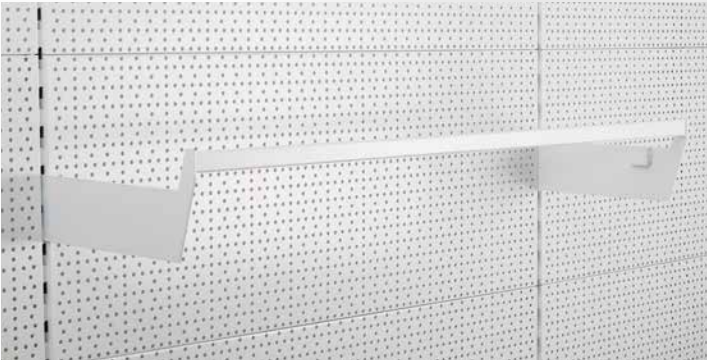

### TARTÓ KONZOL

FESTA állványhoz kompatibilis

R.sz.	leírás	
81152	1000 × 350 × 135 mm	1

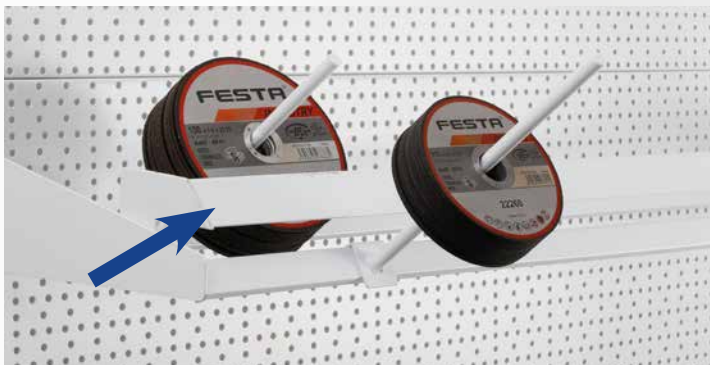
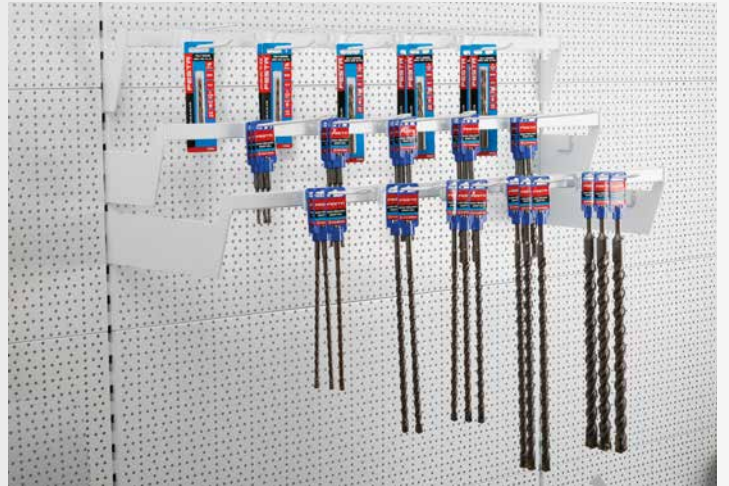

### ÁR CÍMKE TARTÓ

FESTA állványhoz kompatibilis

R.sz.	leírás	
81155	1000 × 80 × 100 mm	1

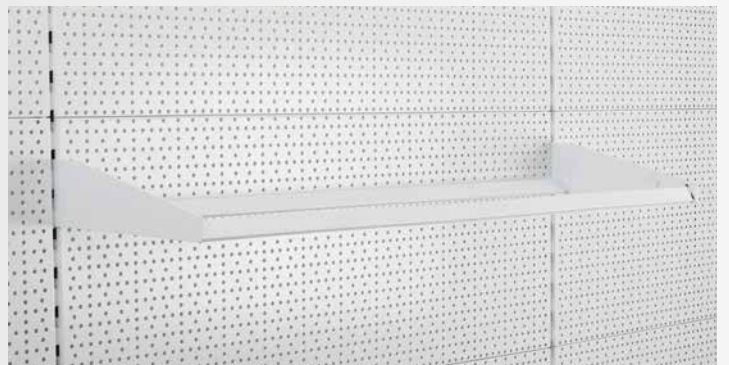

### VÁGÓKORONG TARTÓ KONZOL

FESTA állványhoz kompatibilis

R.sz.	leírás	
81170	1000 × 450 × 85 mm	1

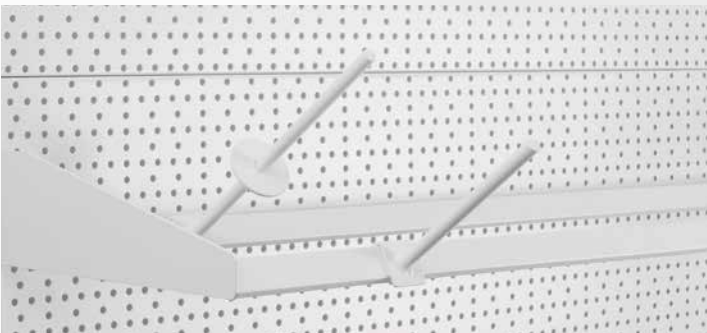

### KAMPÓ VÁGÓKORONGOKHOZ

FESTA állványhoz kompatibilis

R.sz.	leírás	
81186	150 mm	1
81185	250 mm	1



### KAMPÓ AZ AKKUMULÁTOROS SZERSZÁMOKHOZ

FESTA állványhoz kompatibilis

R.sz.	leírás	
81189		1

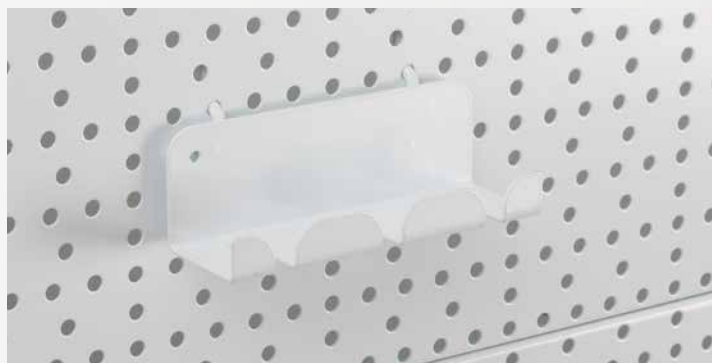

### FÚRÉSZ TARTÓ

FESTA állványhoz kompatibilis

R.sz.	leírás	
81190		1



### GYÉMÁNTVÁGÓ KORONG TARTÓ

FESTA állványhoz kompatibilis

R.sz.	leírás	
81191	220 x 220 x 200 mm	1

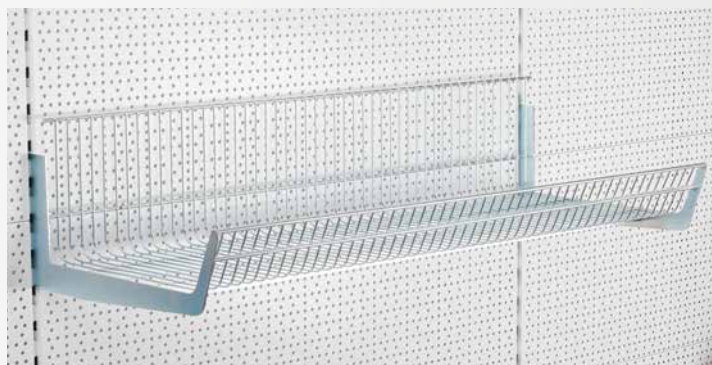

### TARTÓ KOSÁR

FESTA állványhoz kompatibilis

R.sz.	leírás	
81160	1000 x 470 x 180 mm	1



### ELVÁLASZTÓ

FESTA állványhoz kompatibilis

R.sz.	leírás	
81165	470 x 180 mm	1

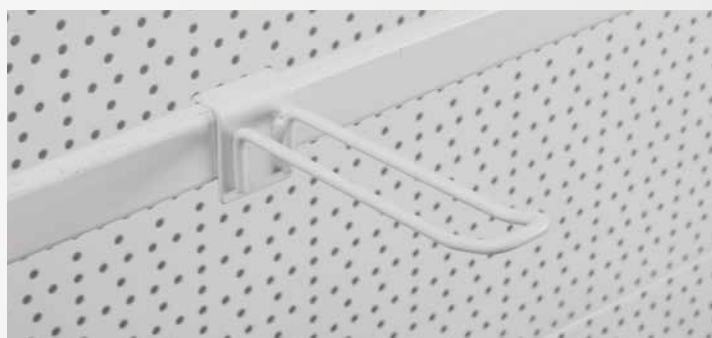

### KAMPÓ KERESZTTARTÓRA

FESTA állványhoz kompatibilis

R.sz.	leírás	
81175	120 mm	1
81178	180 mm	1



### KAMPÓ KERESZTTARTÓRA

FESTA állványhoz kompatibilis

R.sz.	leírás	
81180	120 mm	1



**Kubala**

GLETVAS ROZSDAMENTES

INOX

R.s.	leírás		
33100	130 x 270 mm	síma, 2x gömbölyű sarok (0206)	10



**Kubala**

GLETVAS ROZSDAMENTES

INOX

R.s.	leírás		
33102	130 x 270 mm	síma, G-1 markolat (0473)	10



**Kubala**

GLETVAS ROZSDAMENTES

INOX

R.s.	leírás		
33105	130 x 350 mm	G-8 markolat	6



**Kubala**

GLETVAS ROZSDAMENTES

INOX

R.s.	leírás		
33107	110 x 270 mm	sarok (0483)	10



**Kubala**

GLETVAS ROZSDAMENTES

INOX

R.s.	leírás		
33110	130 x 270 mm	markolat (0240)	10



**Kubala**

GLETVAS ROZSDAMENTES

INOX

R.s.	leírás		
33112	130 x 270 mm	e 6 x 6, G - 11 markolat	10
33113	130 x 270 mm	e 8 x 8, G - 11 markolat	10
33114	130 x 270 mm	e 10 x 10, G - 11 markolat	10



**Kubala**

GLETVAS ROZSDAMENTES

INOX

R.s.	leírás		
33120	130 x 480 mm	síma, G 12 markolat	10

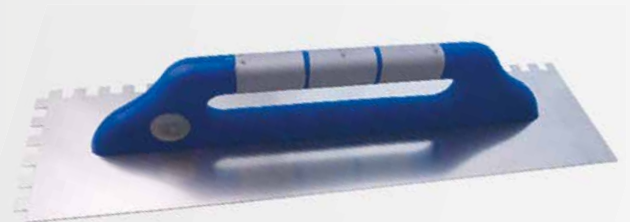

**Kubala**

GLETVAS ROZSDAMENTES

INOX

R.s.	leírás		
33123	130 x 480 mm	e 8 x 8, G-12 markolat	10
33124	130 x 480 mm	e 10 x 10, G-12 markolat	10



**Kubala**

GLETVAS ROZSDAMENTES

INOX

R.s.	leírás	
33127	130 x 480 mm	gömbölyű sarok 10



**Kubala**

GLETVAS ROZSDAMENTES

INOX

R.s.	leírás	
33131	80 x 200 mm	G-1 markolat 10
33132	75 x 95 x 240 mm	trapezoidal G-1 markolat 10



**Kubala**

GLETVAS ROZSDAMENTES

INOX

R.s.	leírás	
33135	130 x 270 mm	horpadt 8 mm, G-1 markolat 10



**Kubala**

GLETVAS ROZSDAMENTES

INOX

R.s.	leírás	
33137	130 x 270 mm	horpadt , G-1 markolat 10



**Kubala**

GLETVAS ROZSDAMENTES

INOX

R.s.	leírás	
33140	50 mm	20
33141	60 mm	20
33142	80 mm	20
33143	100 mm	20



**Kubala**

MŰANYAG SIMÍTÓ ERŐSÍTETT ABS

R.s.	leírás	
33150	130 x 240 mm	12

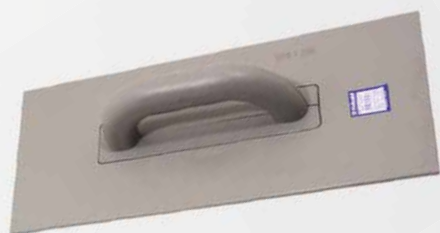

**Kubala**

MŰANYAG SIMÍTÓ ERŐSÍTETT

R.s.	leírás	
33151	180 x 400 mm	1
33152	130 x 600 mm	1



**Kubala**

MŰANYAG SIMÍTÓ ERŐSÍTETT

R.s.	leírás	
33154	130 x 270 mm	G-17 markolat 12

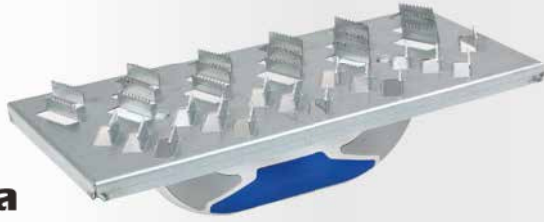

**Kubala**  
KAPARÓ

Zn

R.sz.	leírás
32328	285 x 145 mm

MOQ  
2

10



**Kubala**  
CSISZOLÓ TUSKÓ CSAVAROS

R.sz.	leírás
33160	105 x 210 mm gumi

20

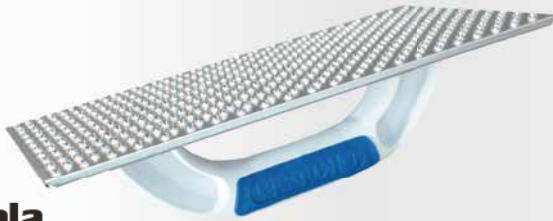

**Kubala**  
KAPARÓ RÉGI VAKOLATRA

INOX

R.sz.	leírás
33162	130 x 270 mm
33163	180 x 400 mm
33164	160 x 380 mm

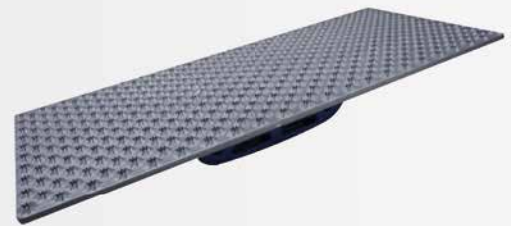
MOQ  
220  
10  
10

**Kubala**  
KAPARÓ RÉGI VAKOLATRA

R.sz.	leírás
33165	165 x 365 mm

MOQ  
2

10



**Kubala**  
KAPARÓ RÉGI VAKOLATRA

R.sz.	leírás
33169	160 x 380 mm G-17 markolat

MOQ  
2

10



**Kubala**  
KAPARÓ RÉGI VAKOLATRA

R.sz.	leírás
33167	130 x 270 mm G-17 markolat
33168	160 x 380 mm G-17 markolat
33170	180 x 400 mm G-17 markolat

MOQ  
220  
10  
10



**Kubala**

SPAKLI ROZSDAMENTES

INOX

R.sz.	leírás	
33200	40 mm	20
33201	60 mm	20
33202	80 mm	20
33203	100 mm	20



**Kubala**

SPAKLI ROZSDAMENTES

INOX

R.sz.	leírás	
33205	130 x 90 mm	20



**Kubala**

SPAKLI ROZSDAMENTES

INOX

R.sz.	leírás	
33206	130 x 37 mm	20



**Kubala**

SPAKLI ROZSDAMENTESÁ

INOX

R.sz.	leírás	
33209	150 mm cserélhető bit	30



**Kubala**

KAPARÓ ROZSDAMENTES

INOX

R.sz.	leírás	
33208	350 x 90 mm	10



**Kubala**

KAPARÓ ROZSDAMENTES

INOX

R.sz.	leírás	
33215	335 x 37 mm	20



**Kubala**

KAPARÓ ROZSDAMENTES

INOX

R.sz.	leírás	
33210	150 mm G-15 markolat	10
33211	250 mm G-15 markolat	10
33212	350 mm G-15 markolat	10



**Kubala**

KAPARÓ ROZSDAMENTES

INOX

R.sz.	leírás	
33215	600 mm AL, G-14 markolat	10



**Kubala**  
KAPARÓ

R.sz.	leírás		
33220	145 mm	gumi	10



**Kubala**  
KAPARÓ PLASTIC

R.sz.	leírás		
33221	245 mm	gumi	10



**Kubala**  
MŰANYAG SIMÍTÓ ERŐSÍTETT

R.sz.	leírás		
33155	95 x 240 mm	gumi	5



**Kubala**  
BURKOLÓVÖDÖR KLT.

R.sz.	leírás		
33250			1



**Kubala**  
BURKOLÓVÖDÖR

R.sz.	leírás		
33254	16 l	rács, kerék	1
33255	20 l	rács, kerék	1



**Kubala**  
KOMPLET FESTÉKEK MINI

R.sz.	leírás		
33252			1



**Kubala**  
PÓT HENGER

R.sz.	leírás		
33257	henger do vödör		1



**Kubala**  
PÓT HENGER

R.sz.	leírás		
33256	henger do vödör		1
33258	henger do vödör		1





**Kubala**

**TÁVTARTÓK SMART LEVEL**

kiegyenlítő ékek 37175, 33246

100x

R.sz.	leírás	
33247	1 mm	15
33248	2 mm	15
33249	3 mm	15

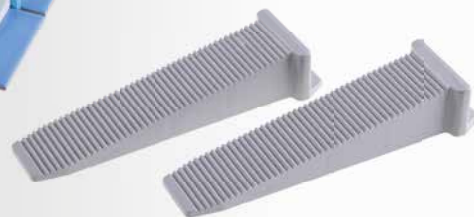

**Kubala**

**KIEGYENLÍTŐ ÉKEK**

50x

R.sz.	leírás	
33246	Smart Level	15



**Kubala**

**KŐMŰVES SERPENYŐ MŰANYAG**

R.sz.	leírás	
33270	175 mm	20



**Kubala**

**GIPSZELŐ EDÉNY**

R.sz.	leírás	
33275	0,5 l	20



**Kubala**

**KAPARÓ GUMI**

R.sz.	leírás	
33280	200 mm	10
37010	135 mm	20



**Kubala**

**MŰGYANTA HENGER**

R.sz.	leírás	
33289	85 x 230 mm	15



**Kubala**

**FESTÉKKAPARÓ**

R.sz.	leírás	
33285	60 mm	1
33286	pót pengék 60mm	1



**Kubala**

**FÚRÓ PORÓZUS**

R.sz.	leírás	
33291	60 mm	1
33292	80 mm	1
33293	120 mm	1



**Kubala**

**MŰANYAG GÉRVÁGÓ DOBOZ**

R.sz.	leírás	
33298	250 x 80 x 50 mm	1
33299	300 x 115 x 65 mm	1







GARÁZSIPAR

432 - 443





## HIDRAULIKUS EMELŐ

A hosszabbító csavar lehetővé teszi a legalacsonyabb magasságállítást és a maximális emelkedést. Kettős biztonságú szelep. Fogazott nyereg lehetővé teszi a nagy felületű emelést és biztonságos fogást. A széles talp stabilitást és erőt biztosít. Minden modellen a nagy igénybevételnek kitett részek meg vannak erősítve, a tartósság és megbízhatóság érdekében.



So.	leírás	terhelhetőség	minimális magasság	emel	Állítsa be a magasságot	alapméretek	súly	
26800		2 000 kg	181mm	116 mm	48 mm	88 x 92 mm	2,6 kg	1
26801		3 000 kg	194 mm	118 mm	60 mm	92 x 100 mm	3,3 kg	1
26802		5 000 kg	216 mm	127 mm	70 mm	96 x 112 mm	4,5 kg	1
26803		8 000 kg	230 mm	147 mm	80 mm	103 x 118 mm	5,7 kg	1
26804		10 000 kg	230 mm	150 mm	80 mm	110 x 123 mm	6,8 kg	1
26805		12 000 kg	230 mm	155 mm	80 mm	116 x 134 mm	7,3 kg	1
26806		15 000 kg	230 mm	150 mm	80 mm	133 x 136 mm	8,4 kg	1
26807		20 000 kg	242 mm	150 mm	60 mm	144 x 152 mm	11 kg	1

## KÉT DUGATTYÚS HIDRAULIKUS EMELŐ

A hosszabbító csavar lehetővé teszi a legalacsonyabb magasságállítást és a maximális emelkedést. Kettős biztonságú szelep. Fogazott nyereg lehetővé teszi a nagy felületű emelést és biztonságos fogást. A széles talp stabilitást és erőt biztosít. Minden modellen a nagy igénybevételnek kitett részek meg vannak erősítve, a tartósság és megbízhatóság érdekében. A hosszabbító csavar lehetővé teszi a legalacsonyabb magasságállítást és a maximális emelkedést. Kettős biztonságú szelep. Fogazott nyereg lehetővé teszi a nagy felületű emelést és biztonságos fogást. A széles talp stabilitást és erőt biztosít. Minden modellen a nagy igénybevételnek kitett részek meg vannak erősítve, a tartósság és megbízhatóság érdekében.



So.	leírás	terhelhetőség	minimális magasság	emel	Állítsa be a magasságot	súly	
26815		2 000 kg	150 mm	160 mm	60 mm	4,7 kg	1
26816		4 000 kg	160 mm	170 mm	60 mm	6,4 kg	1
26817		6 000 kg	215 mm	270 mm	-	8,9 kg	1
26819		10 000 kg	228 mm	284 mm	89 mm	10,2 kg	1



OLLÓS EMELŐ



So.	leírás	terhelhetőség	minimális magasság	max. magasság	súly	
26844		1 000 kg	88 mm	380 mm	2,5 kg	1
26845		2 000 kg	120 mm	395 mm	3,5 kg	1

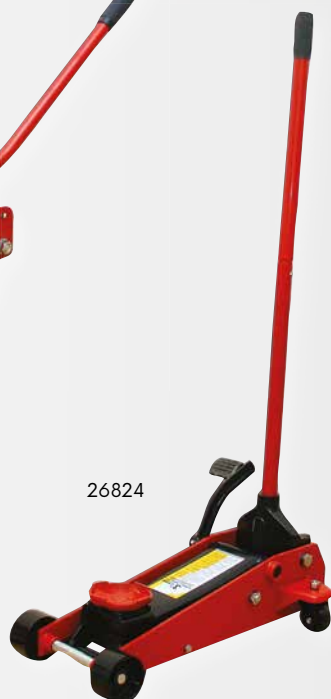

KOCSIS HIDRAULIKUS EMELŐ



So.	leírás	terhelhetőség	minimális magasság	max. magasság	súly	
26820	Kocsis hidraulikus emelő	2 000 kg	130 mm	345 mm	9,6 kg	1
26826	Hidraulikus szerviz emelő, alacsony profil, 360°-ban elforgatható kar	2 000 kg	89 mm	359 mm	14,2 kg	1
26824	Hidraulikus szerviz emelő, pedálos	3 000 kg	145 mm	500 mm	37,2 kg	1
26825	Hidraulikus szerviz emelő,	2 500 kg	85 mm	455 mm	34,8 kg	1



## KOCSIS HIDRAULIKUS EMELŐ+TARTÓBAK

· 360° - ban elforgatható nyél



So.	leírás	terhelhetőség	minimális magasság	max. magasság	súly	
26829	Kocsis hidraulikus emelő 2 db állvány	2 000 kg	130 mm	350 mm	10,5 kg	1
		2 000 kg	275 mm	420 mm	5 kg (pair)	



## TARTÓBAKOK

1 db=1pár!

Finoman állítható kilincsmű, dupla zárvédelemmel. Tömör acél fogantyú. Egységesített vázszerkezet. Állítható vas állvány.



So.	leírás	terhelhetőség	minimális magasság	max. magasság	súly	
26857	biztosító szeggel	2 000 kg	275 mm	420 mm	4,8 kg	1
26858	biztosító szeggel	3 000 kg	285 mm	425 mm	6,3 kg	1
26859	biztosító szeggel	6 000 kg	393 mm	593 mm	13 kg	1
26853		12 000 kg	465 mm	715 mm	28 kg	1



## HIDRAULIKUS KAROS EMELŐDARU

Autóalkatrészek kiemelésére és rögzítésére a beés kiszerezés idejére. A daru gékje helyenként meghosszabbítható. A daru összecsukható, így könnyen tárolható.



So.	leírás	terhelhetőség	minimális magasság	max. magasság	súly	
26862		2 000 kg	0	2360 mm	88 kg	1



## MOTORTARTÓ

A lengő kar felfüggesztése a kámsza dőlésének függvénye. Mindig kiegyensúlyozott és stabil motorrögzítést biztosít.



So.	leírás	terhelhetőség	hossz	hatótávolság	súly	
26871		500 kg	1500 mm	150 mm	20,3 kg	1



## HIDRAULIKUS SEBESSÉGVÁLTÓ TARTÓ

Egységek könnyű ki- és beszereléséhez (motorok, sebességváltók, tengelyek, stb.)



So.	leírás	terhelhetőség	hossz	hatótávolság	súly	
26880	Hidraulikus sebességváltó tartó	500 kg	1100 mm	1900 mm	30,0 kg	1
26881	Emelő hosszabító automata sebességváltóhoz	500 kg	1100 mm	1900 mm	15,0 kg	1



## HIDRAULIKUS KAROSSZERIAJAVÍTÓ, HORDOZHATÓ

Hidraulikus berendezés karosszéria javításához. Dugattyús hengerekkel ellátott készülék, 14 tartozékkal. Széles körben alkalmazható személy- és teherautók karosszériájának a javítására, különösen áramellátás nélküli helyszíneken. Vízszintesen és függőlegesen tolnak, húzhatnak, emelhetők és feszíthetők tartozékokkal. Könnyen szállítható az öntött, ütészálló hord táskával.



So.	leírás	terhelhetőség	hidraulikus emelő	súly	
26886		4 000 kg	125 mm	17,0 kg	1
26888		10 000 kg	135 mm	32,0 kg	1



26920



26921



26922

## MOTORTARTÓ ÁLLVÁNY

Mozgatható állvány motorok szétszereléséhez és javításához. Univerzális befogó egység a motorok rögzítésére és forgatására.



So.	leírás	terhelhetőség	súly	
26920		450 kg	20 kg	1
26921		560 kg	27 kg	1
26922	összezsukható	675 kg	35 kg	1

## KÉZI CSÖRLŐ

Zn

Kiváló minőségű horganyzott csörlő, tartós drótkötéllel.



So.	leírás	Ø Kábel	Max.Capacity	Kábelhosszúság	
26705		4,0mm	450 kg	10 m	1
26706		5,0mm	900 kg	10 m	1
26707		6,0mm	1350 kg	10 m	1
26720		4,0mm	300 kg	10 m	1
26721		4,0mm	500 kg	10 m	1
26722		5,0mm	800 kg	10 m	1

## LÁNCOS EMELŐCSIGA



So.	leírás	Terhelhetőség	Min. magasság	Emelési magasság	Emelőcsigák száma	láncvastagság	Súly	
26700		500 kg	280 mm	3 000 mm	1	6 mm	7,5 kg	1
26701		1 000 kg	300 mm	3 000 mm	1	6 mm	9 kg	1
26702		2 000 kg	380 mm	3 000 mm	2	6 mm	12 kg	1





26897

26943

## RUGÓ ÖSSZENYOMÓ

26897 - McPherson rugóstagok/rugók járműn kívüli cseréjéhez.

26943 - McPherson rugóstagok/rugók járműn kívüli cseréjéhez. Erős acél profilok a nagyobb stabilitásért.



So.	leírás	Terhelhetőség maxima	Ø Összenyomott rugó	Összenyomó hossz	Súly	
26897		1 000 kg	100-200 mm	150 mm	24,5 kg	1
26943		1 000 kg	400 mm	210-570 mm	35 kg	1



## HIDRAULIKUS MŰHELY PRÉS



So.	leírás	Hatótávolság	Max.Capacity	Súly	
26940		0 - 610 mm	12 000 kg	43 kg	1
26941		0 - 880 mm	20 000 kg	75 kg	1



## HIDRAULIKUS CSŐHAJLÍTÓ



So.	leírás	Kapacitás	Emelési magasság	Hajlító pofa	Súly	
26895		12 000 kg	232 mm	1½", 3¼", 1", 1-1¼", 1-1½", 2"	36 kg	1
26896		16 000 kg	238 mm	1½", 3¼", 1", 1-1¼", 1-1½", 2", 2-1½", 3"	65 kg	1

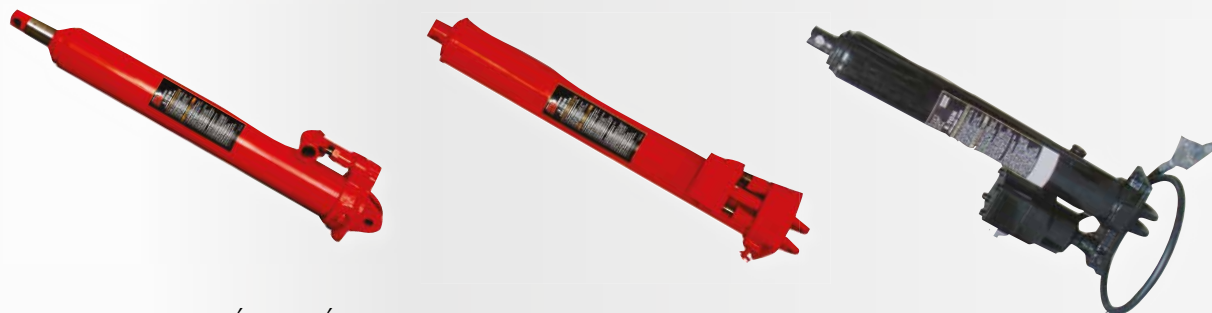

## HIDRAULIKUS TARTÓS PRÉS



So.	leírás	Terhelhetőség	Min. hossz	Max. magasság	Súly	
26911	egy szivattyú	5 000 kg	620	1100	12 kg	2
26912	egy szivattyú	8 000 kg	620	1100	13 kg	2
26914	dupla szivattyú	5 000 kg	620	1100	12 kg	2
26915	dupla szivattyú	8 000 kg	620	1100	14 kg	2



## ALKATRÉSZMOSÓ

Általános tárgyak mosására (alkatrészek, tartozékok, stb.).



So.	leírás	Tartály Kapacitás	Oldószér Kapacitá	Áramlási sebesség	Max. oldószér hőmérséklet	Súly	
26961		90 l	45 l	10-12 l/min.	50°C	25 kg	1
26963		180l	150 l	20 l/min	50°C	42 kg	1



## FÁRADT OLAJ ELSZÍVÓ

A motorból leeresztett olaj a tölcseren keresztül kerül a tartályba. A tartály elszívó berendezéssel van ellátva. A fáradt olaj egy csövön keresztül kiszívható a tartályból.



So.	Terhelhetőség	Max. nyomás	Súly	
26954	90 l	0,5 MPa	28 kg	1



## CSAPÁGYLEHÚZÓ



## CSAPÁGYLEHÚZÓ



So.	max.	magasság	
23734	Ø 100 mm	50-95 mm	1
23735	Ø 150 mm	100-150 mm	1
23736	Ø 200 mm	110-190 mm	1

So.	max.	magasság	
23730	Ø 100 mm	50-95 mm	12
23731	Ø 150 mm	100-150 mm	2
23732	Ø 200 mm	110-190 mm	2

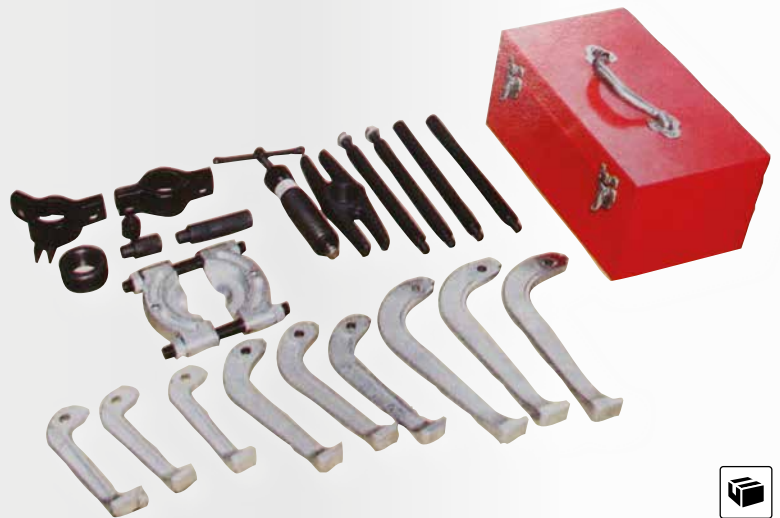

## HIDRAULIKUS CSAPÁGYLEHÚZÓ

Hidraulikus lehúzó készlet. Hidraulikus csavarral, befogópofával, 3 körmös lehúzóval és feszítővel és ölel. Acél kofferben.



So.	leírás	Terhelhetőség	Súly	
26891		12 000 kg	18 kg	1

PÓTALKATRÉSZEK  
HOMOKFÚVÓ SZEKRENY-HEZ

So.	rozsméy	
26973	kesztyűt	1
26974	fűvókák	1
26975	fólia 53,5 x 26 cm	1
26976	plexi 60 x 30 cm	1
26977	üveg 60 x 30 cm	1

## CSISZOLÓ SZEKRENY



So.	Levegőfogyasztás	Külső méret	Belső méret	Max. nyomás	Súly	
26972	420-710 l/min.	1500 x 830 x 630 mm	600 x 840 x 630 mm	8 bar	38 kg	1

**FESTA****SZERSZÁMOS SZEKRÉNY**

So.	Pojezdy zásuvek	Fiókok száma	Teljes méret	
26986	Sima	7	680 x 460 x 1020 mm	1

**SZERSZÁMOS SZEKRÉNY**

A felső szerszámos láda a guruló szekrénybe helyezhető.

So.	leírás	Fiókok csúszása	Fiókok száma	Fiókok belső mérete	Teljes méret	Összsúly	
26985	top case	Sima	3	151,5 x 225 x 40 mm	600 x 260 x 340 mm	11,5 kg	1
			2	511 x 225 x 40 mm			
	bottom case	Sima	1	511 x 225 x 85 mm	616 x 330 x 742 mm	16,4 kg kg	
			2	511 x 308 x 85 mm			



### MÁGNESES TÁLCA



So.	Leírás	
26996	200 x 20 mm	1



### KÉZI CSÖRLŐ



So.	Leírás	
50035	2 t	6
50036	4 t	4



### TÉRDVÉDŐ PAD, GÖRGŐS

So.	
37135	1



### GÖRGŐS ÜLŐKE

párnázott ülőke műanyag szerszámtartó tálcával



So.	Leírás	
26988	360 x 365 x 365 mm	1

### HYDRAULIKUS MINI EMELŐGÉP MODELLEKHEZ

So.	
26998	1

Cikkszám	oldal	Cikkszám	oldal	Cikkszám	oldal	Cikkszám	oldal	Cikkszám	oldal	Cikkszám	oldal
10002	26	12020	31	13275	51	13452	32	14077	35	15230	40
10003	26	12030	31	13276	52	13453	32	14080	34	15235	40
10005	26	12050	31	13277	55	13454	32	14090	35	15310	40
10008	26	12110	31	13278	51	13455	32	14091	35	15315	40
10025	26	12120	31	13279	50	13456	32	14220	36	15318	40
10033	26	12130	31	13280	51	13457	32	14225	36	15320	40
10035	26	12150	31	13281	55	13458	32	14230	36	15325	40
10043	26	12210	31	13282	55	13459	32	14235	36	15330	40
10045	26	12220	31	13284	50	13460	32	14240	36	15335	40
10048	26	12230	31	13285	55	13461	32	14250	36	15340	40
10110	27	12250	31	13290	92	13462	32	14350	36	15415	41
10120	27	12433	31	13293	92	13463	32	14360	36	15418	41
10130	27	12435	31	13294	92	13464	32	14370	36	15420	41
10330	27	13010	32	13295	57	13465	32	14380	36	15425	41
10332	27	13020	32	13296	57	13466	32	14399	36	15430	41
10334	27	13021	32	13350	56	13467	32	14410	37	15510	41
10336	27	13022	32	13351	56	13468	32	14411	37	15515	41
10430	27	13023	32	13352	56	13469	32	14415	36	15518	41
10450	27	13111	32	13353	56	13470	32	14417	36	15520	41
10490	27	13120	32	13354	56	13471	32	14420	36	15525	41
10996	27	13205	54	13355	56	13472	32	14421	36	15530	41
10998	27	13206	54	13360	56	13473	32	14425	37	15535	41
10999	27	13207	54	13361	56	13500	30	14430	37	15540	41
11002	29	13208	54	13362	56	13501	30	14435	37	15615	41
11003	29	13210	32	13363	56	13502	30	14440	37	15620	41
11005	29	13211	32	13364	56	13503	30	14450	37	15625	41
11006	29	13212	54	13365	56	13504	30	14451	37	15630	41
11007	29	13214	53	13399	33	13505	30	14455	37	15710	41
11008	29	13216	53	13400	33	13506	30	14456	37	15715	41
11082	29	13217	53	13401	32	13507	30	14457	37	15720	41
11083	29	13218	53	13402	32	13508	30	14458	37	15725	41
11085	29	13219	53	13403	32	13509	30	14471	37	15730	41
11102	29	13220	32	13404	32	13510	30	14472	37	15735	41
11103	29	13222	53	13405	32	13511	30	14473	37	15740	41
11105	29	13223	53	13406	32	13512	30	14474	37	15810	42
11106	29	13224	53	13407	32	13513	30	14480	35	15812	42
11107	29	13225	53	13408	32	13514	30	14485	37	15815	42
11110	29	13226	53	13409	32	13515	30	14485	42	15818	42
11200	29	13227	53	13410	32	13516	30	14486	37	15820	42
11201	29	13228	53	13411	32	13517	30	14486	42	15825	42
11202	29	13229	53	13412	32	13518	30	14490	37	15830	42
11204	29	13230	53	13413	32	13519	30	14491	37	15850	42
11205	29	13231	53	13414	32	13520	30	14492	37	15853	42
11206	29	13235	53	13415	32	13521	30	14493	37	15855	42
11207	29	13236	53	13416	32	13522	30	14494	37	15860	42
11208	29	13237	53	13417	32	13523	30	15003	39	15870	42
11209	29	13238	53	13418	32	13524	30	15004	39	15880	42
11210	29	13240	55	13419	32	13525	30	15005	39	15885	259
11220	28	13241	55	13420	32	13526	30	15006	39	15886	259
11221	28	13242	55	13421	32	13527	30	15008	39	15886	383
11226	28	13243	55	13422	32	13528	30	15010	39	15887	259
11239	28	13244	55	13423	32	13529	30	15012	39	15887	383
11259	28	13245	55	13424	32	13530	30	15015	39	15888	259
11260	28	13246	54	13425	32	13531	30	15018	39	15888	383
11311	30	13249	56	13426	32	13532	30	15020	39	15889	259
11312	30	13250	56	13427	32	13533	30	15033	38	15904	43
11313	30	13251	56	13428	32	13534	30	15034	38	15906	43
11314	30	13252	56	13429	32	14001	34	15035	38	15908	43
11323	28	13253	56	13430	32	14002	34	15036	38	15910	43
11325	28	13254	56	13431	32	14003	34	15037	38	15912	43
11327	28	13255	57	13432	32	14004	34	15039	38	15915	43
11333	29	13256	57	13433	32	14006	34	15103	39	15920	43
11335	29	13257	57	13434	32	14007	34	15104	39	15954	43
11337	29	13258	57	13435	32	14008	34	15105	39	15956	43
11338	29	13259	57	13436	32	14009	34	15106	39	15958	43
11343	28	13260	55	13437	32	14010	33	15108	39	15960	43
11345	28	13261	52	13438	32	14011	33	15110	39	15962	43
11347	28	13262	50	13439	32	14012	33	15112	39	15965	43
11353	28	13263	50	13440	32	14013	34	15115	39	15970	43
11355	28	13264	51	13441	32	14015	33	15118	39	15980	44
11356	28	13265	50	13442	32	14017	33	15120	39	15981	44
11358	28	13266	50	13443	32	14019	33	15204	40	15983	31
11360	28	13267	50	13444	32	14025	37	15205	40	15985	31
11410	30	13268	51	13445	32	14030	33	15206	40	15988	31
11416	29	13269	50	13446	32	14035	34	15208	40	15989	31
11420	30	13270	50	13447	32	14040	34	15210	40	15990	44
11425	30	13271	50	13448	32	14045	34	15212	40	15991	44
11444	30	13272	51	13449	32	14060	35	15215	40	15992	44
11445	30	13273	51	13450	32	14070	35	15218	40	15993	44
12010	31	13274	52	13451	32	14075	35	15220	40	15996	42

Cikkszám	oldal	Cikkszám	oldal	Cikkszám	oldal	Cikkszám	oldal	Cikkszám	oldal	Cikkszám	oldal
15997	42	16085	167	16991	177	17083	69	17211	73	17351	114
15998	42	16086	167	16991	344	17084	66	17212	74	17352	114
15999	42	16090	165	16998	163	17085	66	17213	74	17353	114
16002	162	16091	165	16999	163	17086	66	17214	74	17357	114
16003	162	16095	167	17001	62	17089	70	17215	74	17359	114
16004	163	16100	164	17002	62	17090	70	17216	75	17360	114
16005	163	16105	164	17003	62	17091	70	17217	75	17361	114
16006	163	16110	164	17004	62	17092	70	17218	75	17380	85
16010	163	16115	164	17005	62	17093	70	17219	75	17381	85
16010	163	16120	164	17006	62	17094	62	17220	77	17382	85
16011	162	16125	164	17007	62	17095	62	17222	77	17383	85
16011	162	16130	166	17008	62	17096	62	17224	77	17384	85
16011	163	16131	164	17009	62	17097	62	17225	76	17385	85
16012	162	16135	166	17010	62	17098	62	17226	76	17386	85
16012	162	16136	165	17011	62	17099	62	17227	76	17390	86
16012	163	16137	165	17012	66	17100	62	17229	78	17391	86
16013	163	16140	166	17013	66	17101	61	17230	79	17392	86
16013	163	16141	169	17014	66	17102	61	17231	79	17393	86
16016	163	16142	165	17015	69	17103	61	17233	79	17394	86
16017	163	16143	165	17016	69	17104	61	17234	79	17395	86
16019	162	16144	165	17017	69	17105	61	17235	80	17396	86
16021	169	16145	165	17019	69	17108	62	17236	80	17397	86
16022	173	16146	166	17020	68	17109	65	17237	80	17398	86
16023	167	16147	166	17021	68	17110	62	17238	110	17400	86
16024	169	16150	164	17022	68	17111	70	17238	78	17401	85
16025	166	16151	164	17023	65	17112	70	17240	81	17402	85
16026	169	16198	176	17024	62	17116	70	17241	81	17405	85
16028	169	16199	176	17025	64	17117	70	17242	81	17406	85
16029	166	16201	173	17026	179	17121	70	17243	81	17407	85
16030	168	16202	63	17027	179	17122	70	17244	81	17410	85
16031	168	16209	175	17028	68	17125	63	17245	78	17411	85
16032	168	16210	174	17029	68	17126	63	17247	111	17412	85
16033	168	16211	174	17033	66	17127	63	17250	77	17413	85
16034	166	16212	173	17034	65	17128	63	17255	77	17414	85
16035	168	16218	174	17035	65	17130	63	17259	111	17415	85
16036	168	16219	174	17036	65	17133	63	17260	110	17416	85
16037	167	16220	174	17037	179	17135	63	17261	91	17420	85
16038	168	16221	174	17038	69	17137	63	17262	91	17421	85
16041	168	16222	175	17039	68	17138	63	17292	81	17422	85
16042	170	16223	175	17040	64	17140	61	17294	81	17427	85
16042	284	16224	175	17041	64	17142	61	17295	81	17450	91
16043	169	16225	173	17042	64	17145	61	17296	81	17451	91
16046	169	16226	175	17043	64	17146	61	17297	81	17455	86
16049	170	16227	175	17044	64	17148	61	17298	81	17456	86
16050	170	16228	175	17045	64	17155	71	17299	81	17458	86
16051	170	16229	173	17046	68	17156	71	17300	69	17459	86
16052	170	16230	173	17047	64	17158	72	17301	69	17460	88
16053	169	16231	127	17048	68	17159	72	17302	69	17461	88
16054	170	16231	173	17050	72	17160	72	17303	69	17462	88
16055	169	16232	65	17050	179	17165	71	17304	69	17463	88
16056	284	16232	176	17051	68	17167	71	17305	69	17464	88
16057	167	16234	173	17052	68	17169	71	17306	69	17465	88
16058	167	16235	174	17053	68	17170	71	17308	82	17466	88
16059	170	16236	174	17054	68	17175	71	17309	82	17467	88
16060	172	16281	177	17055	68	17177	71	17310	82	17468	88
16061	172	16282	177	17056	68	17180	63	17311	82	17469	88
16062	171	16300	180	17057	68	17181	63	17312	82	17470	88
16063	171	16301	180	17058	68	17182	178	17313	82	17471	88
16064	171	16303	180	17059	66	17183	178	17314	82	17472	88
16065	171	16304	180	17060	66	17185	72	17315	82	17473	88
16066	164	16310	180	17061	66	17186	71	17316	82	17475	89
16066	171	16310	180	17062	66	17187	139	17317	82	17476	89
16067	171	16311	180	17063	67	17188	139	17318	82	17480	88
16068	171	16311	180	17064	67	17189	139	17319	82	17481	88
16069	170	16311	180	17065	67	17190	64	17320	82	17482	88
16070	170	16312	180	17066	67	17191	64	17321	82	17483	88
16070	172	16312	180	17067	67	17192	64	17322	82	17484	88
16071	167	16315	179	17068	67	17193	64	17324	82	17485	88
16071	172	16315	179	17069	67	17197	88	17327	82	17486	88
16072	172	16320	180	17070	67	17198	88	17330	82	17487	87
16073	172	16321	143	17071	67	17199	88	17332	82	17488	87
16074	167	16321	180	17072	67	17200	88	17333	82	17489	87
16074	172	16401	72	17075	67	17201	88	17334	82	17490	87
16075	172	16405	72	17076	67	17202	88	17335	77	17491	87
16077	171	16406	72	17077	67	17203	91	17336	77	17492	87
16078	171	16407	72	17078	69	17204	91	17337	77	17493	87
16081	171	16408	72	17079	66	17205	91	17338	77	17494	87
16082	170	16420	72	17080	66	17206	91	17345	76	17495	87
16083	172	16990	177	17081	66	17208	77	17346	76	17496	87
16084	172	16990	344	17082	66	17210	73	17350	114	17501	90

Cikkszám	oldal	Cikkszám	oldal	Cikkszám	oldal	Cikkszám	oldal	Cikkszám	oldal	Cikkszám	oldal
17506	89	17631	87	17851	83	18066	94	18416	99	18607	106
17508	89	17632	87	17852	83	18067	94	18417	99	18608	98
17512	89	17633	87	17853	83	18070	94	18418	97	18610	106
17526	89	17640	90	17854	83	18071	94	18419	99	18611	106
17528	89	17642	90	17855	83	18072	94	18420	99	18612	106
17532	89	17643	90	17856	83	18075	94	18421	109	18613	106
17533	89	17644	90	17860	82	18076	94	18422	95	18614	106
17534	89	17645	90	17861	82	18077	94	18423	96	18615	106
17539	89	17650	90	17862	82	18080	94	18424	95	18618	106
17548	87	17651	90	17863	82	18081	94	18425	98	18619	105
17549	87	17652	90	17864	82	18082	94	18426	96	18619	86
17550	87	17653	90	17865	82	18083	94	18430	109	18620	103
17551	87	17654	90	17866	82	18084	94	18431	99	18621	103
17552	87	17655	90	17867	82	18085	94	18433	98	18623	103
17553	87	17656	90	17868	82	18086	94	18435	100	18625	103
17554	87	17657	90	17869	82	18087	94	18437	96	18627	103
17555	87	17658	90	17870	82	18088	94	18440	109	18628	103
17556	87	17659	90	17871	82	18089	94	18450	98	18630	103
17557	87	17660	87	17872	82	18090	94	18451	98	18631	103
17558	87	17661	87	17873	82	18091	94	18455	94	18632	103
17559	87	17662	87	17874	82	18092	94	18456	94	18632A	102
17560	87	17663	87	17875	82	18101	97	18460	94	18633	103
17561	87	17664	87	17876	82	18102	97	18466	113	18633A	102
17562	87	17665	87	17877	82	18103	97	18468	113	18634	103
17563	87	17666	87	17878	82	18104	97	18476	113	18635	103
17564	87	17667	87	17879	82	18105	97	18477	113	18636	103
17565	87	17668	87	17880	82	18106	97	18490	112	18636A	102
17566	87	17669	87	17881	82	18107	97	18491	112	18637	103
17567	87	17670	87	17882	82	18108	97	18492	112	18637A	102
17568	87	17671	87	17883	82	18110	98	18493	112	18638	103
17569	87	17672	87	17884	82	18113	93	18494	114	18638A	102
17570	87	17674	87	17885	82	18114	93	18495	114	18639	103
17571	87	17675	87	17886	82	18115	93	18496	112	18640	103
17572	87	17676	87	17887	82	18116	93	18497	112	18641	103
17573	87	17677	87	17888	82	18118	93	18498	112	18645	103
17574	87	17678	87	17889	82	18120	93	18499	114	18646	103
17575	87	17679	87	17890	82	18124	93	18500	112	18680	103
17576	87	17680	90	17891	82	18125	93	18508	113	18685	103
17577	87	17681	90	17892	82	18201	97	18510	113	18750	103
17578	87	17682	90	17895	83	18202	97	18511	113	18751	103
17579	87	17683	87	17896	83	18203	97	18512	113	18753	103
17580	87	17685	88	17897	83	18204	97	18513	113	18755	103
17581	87	17761	88	17898	83	18210	93	18514	113	18760	103
17582	87	17769	88	17902	83	18211	93	18515	113	18761	103
17583	87	17788	88	17904	83	18212	93	18516	113	18762	103
17584	87	17789	88	17905	83	18215	93	18518	113	18763	103
17585	87	17795	88	17907	83	18216	93	18519	113	18764	103
17586	87	17806	88	17910	83	18301	97	18520	113	18765	103
17587	87	17810	82	17912	83	18302	97	18521	113	18766	103
17589	87	17811	82	17913	83	18303	97	18522	113	18767	103
17590	87	17812	82	17914	83	18304	97	18523	113	18768	103
17591	87	17820	82	17916	83	18310	93	18524	113	18769	103
17592	87	17821	82	17922	83	18311	93	18527	113	18770	103
17593	87	17822	82	17924	83	18312	93	18548	113	18771	103
17600	91	17823	82	17925	83	18313	93	18559	113	18772	103
17601	91	17824	82	17926	83	18321	93	18562	113	18775	103
17603	91	17825	82	17927	83	18322	93	18567	113	18776	103
17605	88	17826	82	17930	83	18340	95	18572	113	18777	103
17606	88	17827	82	17931	83	18350	94	18575	113	18795	105
17607	88	17828	82	17932	83	18351	94	18576	113	18796	105
17608	88	17829	82	17933	83	18352	94	18577	113	18797	105
17609	88	17830	82	17934	83	18353	94	18578	113	18798	105
17610	88	17831	82	17935	83	18354	94	18579	113	18799	106
17611	88	17832	82	17943	83	18355	94	18580	113	18800	104
17612	88	17835	83	17944	83	18356	94	18581	113	18801	104
17613	88	17836	83	17970	104	18357	94	18582	113	18802	104
17614	88	17837	83	17971	104	18358	94	18583	113	18803	104
17615	88	17838	83	17972	104	18359	94	18584	113	18804	104
17616	88	17839	83	17973	104	18360	94	18585	113	18805	104
17617	88	17840	83	17974	104	18400	97	18586	113	18806	104
17620	90	17841	83	17975	104	18401	97	18587	113	18807	104
17621	90	17842	83	17976	104	18402	95	18588	113	18810	104
17622	87	17843	83	17980	104	18403	95	18589	113	18811	104
17623	87	17844	83	17981	104	18404	95	18593	113	18812	104
17624	87	17845	83	17982	104	18408	100	18600	105	18813	104
17625	87	17846	83	17983	104	18409	100	18601	105	18814	104
17626	87	17847	83	18062	94	18410	96	18602	106	18815	104
17628	87	17848	83	18063	94	18411	96	18603	81	18816	104
17629	87	17849	83	18064	94	18413	96	18604	86	18817	104
17630	87	17850	83	18065	94	18415	99	18605	106	18820	104



Cikkszám	oldal	Cikkszám	oldal	Cikkszám	oldal	Cikkszám	oldal	Cikkszám	oldal	Cikkszám	oldal
18821	104	18957	84	19115	142	19410	126	19537	185	19607	185
18822	104	18960	84	19124	118	19410	202	19538	185	19608	185
18823	104	18961	84	19136	118	19411	126	19539	185	19609	185
18824	104	18963	84	19148	118	19411	202	19540	185	19610	185
18825	104	18971	84	19149	118	19412	126	19540	185	19610	185
18826	104	18993	107	19150	117	19412	202	19541	185	19611	185
18827	104	18994	107	19151	117	19415	125	19542	185	19612	185
18827A	102	19001	116	19200	120	19416	125	19543	185	19613	185
18828	104	19002	116	19202	120	19418	126	19544	185	19614	185
18828A	102	19003	116	19208	121	19418	202	19545	185	19615	185
18829	104	19004	116	19209	121	19419	126	19545	185	19615	185
18830	104	19005	116	19211	121	19419	202	19546	185	19616	185
18830A	102	19006	116	19245	120	19421	125	19547	185	19617	185
18831	104	19008	116	19246	120	19422	125	19548	185	19618	185
18831A	102	19010	116	19247	120	19423	125	19550	185	19619	185
18832	104	19015	116	19248	120	19424	125	19550	185	19620	185
18835	104	19020	116	19249	120	19425	125	19552	185	19620	185
18836	104	19021	116	19251	121	19426	125	19552	185	19621	185
18837	104	19022	116	19252	121	19427	125	19553	185	19622	185
18838	104	19023	116	19253	121	19429	202	19554	185	19623	185
18839	104	19024	116	19254	120	19430	119	19555	185	19624	185
18840	104	19025	116	19255	120	19431	119	19555	185	19625	185
18841	104	19026	116	19265	120	19432	119	19556	185	19625	185
18842	104	19028	116	19270	120	19433	119	19557	185	19626	185
18843	104	19030	116	19271	120	19434	119	19558	185	19627	185
18844	104	19031	116	19272	120	19435	119	19558	185	19628	185
18845	104	19032	116	19290	120	19436	126	19559	185	19629	185
18846	104	19034	116	19293	120	19436	202	19560	185	19630	185
18847	104	19036	116	19294	120	19440	119	19560	185	19630	185
18850	104	19041	115	19295	120	19441	119	19561	185	19631	185
18851	104	19042	115	19297	121	19442	119	19562	185	19632	185
18852	104	19043	115	19301	123	19443	119	19562	185	19633	185
18853	104	19044	115	19303	118	19450	127	19563	185	19634	185
18855	104	19045	115	19306	123	19451	127	19564	185	19635	185
18856	104	19046	115	19308	123	19455	127	19565	185	19635	185
18860	104	19050	116	19310	123	19457	127	19565	185	19636	185
18861	104	19051	118	19312	123	19458	128	19567	185	19637	185
18862	104	19052	118	19314	123	19459	128	19568	185	19638	185
18863	104	19053	116	19326	123	19460	126	19568	185	19639	185
18864	104	19054	116	19328	123	19462	124	19569	185	19640	185
18865	104	19055	116	19330	123	19463	124	19570	185	19640	185
18866	104	19056	116	19332	123	19464	124	19570	185	19641	185
18867	104	19057	116	19333	123	19465	124	19573	185	19642	185
18868	105	19058	116	19335	123	19469	124	19574	185	19643	185
18869	105	19059	116	19337	123	19470	126	19575	185	19644	185
18870	105	19060	118	19340	122	19472	203	19575	185	19645	185
18871	105	19061	117	19356	124	19473	203	19576	185	19645	185
18872	105	19062	117	19357	124	19474	203	19577	185	19646	185
18873	105	19063	117	19370	123	19477	203	19578	185	19647	185
18874	105	19064	117	19371	123	19478	203	19579	185	19648	185
18900	108	19065	118	19374	124	19480	203	19580	185	19649	185
18901	108	19066	116	19380	122	19481	203	19580	185	19650	185
18905	108	19067	116	19381	122	19482	203	19581	185	19650	185
18906	108	19068	116	19382	122	19483	203	19583	185	19651	185
18907	109	19069	116	19383	122	19485	202	19584	185	19652	185
18909	108	19070	116	19384	122	19486	202	19585	185	19653	185
18910	100	19071	116	19385	122	19487	202	19585	185	19654	185
18915	109	19074	115	19387	122	19490	127	19586	185	19655	185
18916	109	19075	115	19388	122	19491	127	19587	185	19656	185
18920	84	19076	115	19389	122	19492	127	19588	185	19657	185
18921	84	19077	115	19390	123	19493	127	19589	185	19658	185
18922	84	19081	115	19391	122	19494	127	19590	185	19659	185
18925	84	19082	115	19392	123	19495	127	19590	185	19660	185
18926	84	19083	115	19393	124	19496	127	19591	185	19661	185
18927	84	19084	115	19394	124	19497	127	19593	185	19662	185
18928	84	19085	115	19395	124	19498	127	19594	185	19663	185
18929	84	19086	115	19396	124	19499	127	19595	185	19664	185
18930	84	19088	115	19397	124	19501	127	19595	185	19665	185
18931	84	19090	115	19398	119	19502	127	19596	185	19669	185
18934	84	19092	115	19399	119	19510	128	19597	185	19670	186
18937	84	19095	115	19400	126	19515	128	19598	185	19671	186
18939	84	19096	115	19401	126	19520	128	19599	185	19672	186
18944	84	19097	115	19402	126	19530	185	19600	185	19673	186
18945	84	19098	115	19403	126	19530	185	19600	185	19673	186
18948	84	19100	117	19404	126	19532	185	19601	185	19674	186
18950	84	19106	115	19405	126	19533	185	19603	185	19675	186
18951	84	19108	115	19406	126	19534	185	19604	185	19676	186
18954	84	19109	115	19407	126	19535	185	19605	185	19677	186
18955	84	19110	128	19408	126	19535	185	19605	185	19678	186
18956	84	19115	118	19409	126	19536	185	19606	185	19678	186

Cikkszám oldal	Cikkszám oldal	Cikkszám oldal	Cikkszám oldal	Cikkszám oldal	Cikkszám oldal						
19679	186	19743	186	20235	187	20493	191	20767	194	20942	197
19680	186	19743	186	20240	187	20494	191	20768	194	20943	197
19681	186	19744	186	20245	187	20495	191	20769	194	20944	197
19682	186	19745	186	20250	187	20496	191	20770	194	20945	197
19683	186	19746	186	20255	187	20508	195	20771	194	20946	197
19683	186	19747	186	20260	187	20510	195	20772	194	20947	197
19684	186	19748	186	20270	187	20511	195	20773	194	20948	197
19685	186	19748	186	20280	187	20512	195	20774	194	20949	197
19686	186	19749	186	20290	187	20513	195	20775	194	20950	196
19687	186	19750	186	20296	187	20514	195	20776	194	20952	196
19688	186	19751	186	20300	189	20515	195	20777	194	20954	196
19688	186	19752	186	20305	189	20516	195	20778	194	20956	197
19689	186	19753	186	20310	189	20520	195	20779	194	20957	204
19690	186	19753	186	20311	189	20521	195	20780	194	20958	204
19691	186	19754	186	20315	190	20522	195	20781	194	20960	209
19692	186	19755	186	20316	189	20523	195	20782	194	20961	209
19693	186	19756	186	20317	189	20524	195	20783	194	20963	209
19693	186	19757	186	20320	190	20525	195	20784	194	20965	209
19694	186	19758	186	20321	190	20526	195	20785	194	20966	209
19695	186	19758	186	20333	188	20673	194	20786	194	20967	90
19695	186	19759	186	20334	188	20674	194	20787	194	20968	90
19696	186	19760	186	20335	188	20675	194	20788	194	20969	90
19697	186	19761	186	20336	188	20676	194	20789	194	20970	209
19698	186	19762	186	20337	188	20677	194	20790	194	20971	209
19698	186	19763	186	20338	188	20678	194	20791	194	20972	209
19699	186	19763	186	20350	203	20680	194	20792	194	20973	209
19700	186	19764	186	20360	180	20682	194	20793	194	20980	204
19701	186	19765	186	20361	180	20684	194	20794	194	20981	204
19701	186	19766	186	20363	71	20685	194	20795	194	20982	204
19702	186	19767	186	20365	209	20686	194	20796	194	20983	204
19703	186	19768	186	20379	199	20687	194	20797	194	20984	204
19703	186	19768	186	20380	190	20688	194	20798	194	20990	197
19704	186	19769	186	20381	208	20690	194	20799	194	20991	197
19705	186	19770	186	20385	193	20691	194	20805	195	20992	197
19705	186	19771	186	20386	193	20692	194	20820	195	20999	195
19706	186	19772	186	20387	193	20694	194	20825	194	21010	236
19707	186	19772	186	20390	193	20696	194	20855	194	21011	236
19708	186	19773	186	20391	193	20697	194	20861	194	21012	236
19708	186	19774	186	20395	193	20698	194	20862	194	21015	236
19709	186	19775	186	20396	193	20724	204	20870	194	21018	236
19710	186	19776	186	20397	193	20725	204	20871	194	21023	236
19711	186	19776	186	20400	187	20726	204	20872	194	21110	236
19711	186	19777	186	20401	187	20727	204	20873	194	21111	236
19712	186	19778	186	20402	187	20728	204	20874	194	21112	236
19713	186	19779	186	20403	187	20729	204	20875	194	21115	236
19713	186	19780	186	20404	187	20730	204	20876	194	21118	236
19714	186	19781	186	20405	187	20731	204	20877	194	21123	236
19715	186	19781	186	20406	187	20732	204	20878	194	21130	236
19716	186	19782	186	20407	187	20733	204	20879	194	21135	236
19717	186	19783	186	20408	187	20734	204	20880	194	21140	236
19718	186	19783	186	20409	187	20735	204	20881	194	21150	236
19718	186	19784	186	20410	187	20736	204	20890	195	21180	236
19719	186	19785	186	20411	187	20737	204	20891	195	21190	236
19720	186	19786	186	20412	187	20738	204	20895	195	21192	239
19721	186	19786	186	20413	187	20739	204	20896	204	21194	239
19722	186	19787	186	20414	187	20740	204	20897	204	21195	237
19723	186	19788	186	20415	187	20741	204	20898	204	21200	234
19723	186	19789	186	20416	187	20743	106	20899	204	21201	234
19724	186	19790	186	20417	187	20743	197	20901	205	21203	234
19725	186	19791	186	20418	187	20744	197	20905	204	21204	234
19726	186	19792	186	20419	187	20744	208	20910	204	21210	234
19727	186	19793	186	20420	187	20745	208	20911	204	21211	234
19728	186	19794	186	20421	187	20748	194	20912	204	21212	234
19728	186	19795	186	20422	187	20749	194	20913	204	21215	234
19729	186	19796	186	20423	187	20750	194	20915	204	21218	234
19730	186	19797	186	20424	187	20751	194	20916	204	21219	234
19731	186	19798	186	20425	187	20752	194	20917	204	21220	234
19732	186	19799	186	20426	187	20753	194	20918	204	21223	234
19733	186	19800	186	20427	187	20754	194	20919	204	21224	234
19733	186	19801	186	20428	187	20755	194	20920	204	21301	235
19734	186	19802	186	20429	187	20756	194	20921	204	21303	235
19735	186	19841	187	20430	187	20757	194	20922	204	21306	239
19736	186	19842	187	20450	205	20758	194	20923	204	21308	239
19737	186	19845	187	20460	205	20759	194	20924	204	21311	235
19738	186	19885	187	20487	191	20760	194	20936	196	21312	235
19738	186	19895	187	20488	191	20761	194	20937	197	21315	235
19739	186	20210	205	20489	191	20762	194	20938	197	21318	235
19740	186	20220	187	20490	191	20764	194	20939	197	21323	235
19741	186	20225	187	20491	191	20765	194	20940	197	21324	235
19742	186	20230	187	20492	191	20766	194	20941	197	21326	235

Cikkszám	oldal	Cikkszám	oldal	Cikkszám	oldal	Cikkszám	oldal	Cikkszám	oldal	Cikkszám	oldal
21327	235	21803	240	22031	212	22113	218	22222	238	22535	184
21410	235	21804	240	22032	212	22115	218	22224	238	22540	184
21411	235	21810	216	22033	213	22116	218	22225	238	22542	184
21412	235	21811	216	22034	213	22117	218	22228	238	22545	184
21415	235	21812	216	22035	213	22120	219	22229	238	22548	184
21418	235	21813	216	22036	213	22121	219	22230	239	22550	184
21423	235	21814	216	22037	211	22122	219	22232	239	22555	184
21424	235	21831	216	22038	211	22123	219	22234	239	22560	184
21425	237	21832	216	22039	211	22124	219	22236	239	22565	184
21426	237	21834	216	22040	211	22125	219	22238	239	22568	184
21427	237	21850	218	22041	214	22126	219	22240	238	22570	184
21428	237	21851	218	22042	214	22129	219	22242	238	22575	184
21430	237	21852	218	22043	214	22130	219	22244	238	22580	184
21431	237	21853	218	22044	214	22132	219	22246	238	22585	184
21432	237	21854	218	22045	216	22133	219	22248	238	22590	184
21440	204	21855	218	22046	216	22134	219	22251	238	22595	184
21441	204	21856	218	22047	216	22135	381	22252	238	22600	184
21442	204	21857	218	22048	216	22136	381	22253	238	22602	184
21443	204	21858	218	22049	216	22137	381	22254	238	22605	184
21444	204	21859	218	22050	216	22138	381	22255	238	22610	184
21445	204	21860	218	22051	216	22140	241	22258	238	22615	184
21446	204	21861	218	22052	216	22141	241	22259	238	22620	184
21450	205	21862	218	22053	216	22142	241	22260	238	22625	184
21451	205	21863	218	22054	216	22143	241	22263	238	22630	184
21452	205	21864	218	22055	216	22145	241	22264	238	22701	214
21453	206	21900	210	22056	216	22146	241	22266	238	22702	214
21454	206	21901	210	22057	216	22147	241	22269	238	22703	214
21530	205	21902	210	22058	212	22148	241	22270	238	22704	214
21540	206	21903	210	22059	212	22150	241	22273	238	22705	214
21541	206	21904	210	22060	214	22151	241	22274	238	22706	214
21701	217	21905	210	22061	214	22155	241	22275	238	22707	214
21702	217	21906	210	22062	214	22156	241	22277	238	23000	400
21703	217	21907	211	22063	214	22158	213	22280	238	23001	400
21704	217	21908	211	22064	214	22159	213	22281	238	23005	402
21705	217	21909	211	22065	215	22160	216	22285	239	23006	402
21706	217	21910	211	22066	215	22161	216	22286	239	23010	402
21709	217	21911	211	22067	217	22162	216	22294	239	23020	402
21715	217	21912	211	22068	215	22163	216	22300	222	23025	402
21716	217	21913	211	22069	215	22164	216	22301	222	23030	402
21717	217	21914	211	22070	215	22166	216	22302	222	23035	402
21718	217	21920	210	22071	215	22167	216	22303	222	23040	402
21719	217	21925	210	22072	215	22168	216	22305	222	23050	402
21720	217	21926	210	22073	214	22170	221	22307	222	23060	402
21721	217	21930	212	22074	214	22171	221	22309	222	23070	402
21724	217	21931	212	22075	217	22172	221	22310	222	23125	401
21732	217	21935	212	22076	217	22173	221	22311	222	23130	401
21734	217	21936	212	22077	217	22174	221	22312	222	23135	401
21735	217	21937	212	22078	213	22178	220	22313	222	23140	401
21736	217	21940	212	22079	213	22180	220	22314	222	23150	401
21737	217	21941	212	22080	213	22181	220	22315	222	23160	401
21740	217	22001	210	22081	213	22182	220	22317	222	23211	401
21741	217	22002	210	22082	213	22183	220	22318	222	23212	401
21742	217	22003	210	22083	215	22184	220	22319	222	23213	401
21743	217	22004	211	22084	215	22185	220	22320	222	23214	401
21744	217	22005	211	22085	215	22186	220	22322	222	23215	401
21750	217	22006	211	22086	213	22188	221	22324	222	23220	401
21751	217	22007	210	22087	214	22189	221	22326	222	23225	401
21752	217	22008	210	22088	215	22190	221	22328	222	23232	401
21753	217	22009	210	22090	215	22195	221	22329	222	23240	401
21754	217	22010	210	22091	215	22197	221	22332	222	23250	401
21780	241	22011	210	22092	215	22198	221	22333	222	23260	401
21781	241	22012	211	22093	215	22199	221	22335	222	23261	401
21782	241	22013	211	22095	215	22200	199	22337	222	23262	401
21783	241	22014	211	22096	216	22201	199	22340	222	23263	401
21784	241	22015	211	22097	216	22202	221	22343	222	23264	401
21786	241	22016	211	22098	216	22203	221	22345	222	23265	401
21787	241	22017	211	22099	216	22204	221	22350	222	23266	401
21788	241	22018	212	22100	218	22205	221	22351	222	23274	401
21789	241	22019	212	22101	218	22206	220	22355	222	23275	401
21790	241	22020	212	22102	218	22207	220	22357	222	23281	403
21792	241	22021	212	22103	218	22208	220	22365	222	23282	403
21793	241	22022	212	22104	218	22209	220	22370	222	23284	403
21794	241	22023	211	22105	218	22211	238	22398	222	23287	402
21795	241	22024	211	22106	218	22212	238	22399	222	23288	402
21796	241	22025	211	22107	218	22215	238	22510	184	23290	403
21798	215	22026	212	22108	218	22216	238	22515	184	23291	403
21798	241	22027	212	22109	218	22217	238	22520	184	23292	403
21800	240	22028	212	22110	218	22218	238	22525	184	23297	403
21801	240	22029	212	22111	218	22219	238	22530	184	23310	401
21802	240	22030	212	22112	218	22220	238	22532	184	23311	401

Cikkszám	oldal	Cikkszám	oldal	Cikkszám	oldal	Cikkszám	oldal	Cikkszám	oldal	Cikkszám	oldal
23312	401	23735	139	24001	137	24148	230	24483	192	24779	201
23390	403	23736	441	24002	137	24149	230	24650	200	24780	201
23391	403	23736	139	24005	137	24150	231	24655	201	24781	201
23400	133	23760	130	24006	137	24151	231	24658	201	24782	201
23401	133	23761	130	24007	136	24152	232	24670	200	24783	201
23402	133	23762	130	24010	136	24152	339	24671	200	24784	201
23406	133	23763	130	24015	137	24153	228	24672	200	24785	201
23407	133	23764	130	24017	137	24154	231	24673	200	24786	201
23410	133	23800	130	24020	137	24155	233	24674	200	24787	201
23411	133	23810	410	24030	137	24156	233	24675	200	24788	201
23412	133	23814	410	24035	138	24158	233	24676	200	24789	201
23415	133	23816	410	24036	138	24159	219	24690	209	24790	200
23416	133	23818	410	24038	138	24159	233	24691	209	24791	200
23417	133	23820	410	24039	138	24160	227	24695	209	24792	200
23420	133	23824	410	24040	138	24161	227	24700	200	24793	200
23506	132	23826	410	24041	138	24162	227	24701	200	24794	200
23507	132	23828	410	24042	138	24163	227	24702	200	24795	201
23508	132	23830	410	24043	138	24164	227	24703	200	24796	200
23515	132	23840	345	24045	224	24165	227	24704	200	24798	200
23520	132	23845	344	24050	226	24166	227	24705	200	25001	323
23525	132	23846	344	24055	223	24167	227	24706	207	25002	323
23530	132	23847	344	24055	282	24168	227	24712	207	25003	323
23531	132	23850	410	24060	223	24169	227	24713	208	25004	323
23551	132	23854	410	24061	223	24170	229	24714	208	25005	323
23560	131	23856	410	24062	223	24171	230	24715	208	25006	322
23561	131	23858	410	24063	223	24173	231	24716	208	25009	322
23562	131	23860	410	24064	223	24174	233	24717	198	25012	322
23563	131	23864	410	24065	223	24175	233	24718	198	25015	322
23564	131	23865	410	24066	223	24176	233	24719	198	25016	322
23565	131	23866	410	24067	223	24177	233	24720	208	25020	322
23566	131	23868	410	24068	223	24178	233	24721	208	25024	322
23570	131	23870	410	24069	223	24180	228	24722	208	25025	322
23571	131	23875	394	24070	223	24181	233	24723	198	25030	322
23572	131	23880	410	24071	223	24185	227	24725	198	25040	322
23573	131	23882	410	24072	223	24186	227	24726	198	25048	322
23574	131	23884	410	24073	223	24187	227	24727	295	25060	322
23585	132	23904	130	24074	223	24188	227	24728	295	25096	322
23587	132	23906	130	24075	223	24189	227	24729	295	25150	322
23589	132	23908	130	24076	223	24190	219	24730	197	25153	322
23591	132	23910	130	24077	223	24190	233	24731	197	25155	322
23600	132	23912	130	24078	223	24192	227	24732	197	25160	323
23601	132	23914	130	24080	224	24195	227	24735	199	25162	323
23602	132	23920	130	24081	224	24196	227	24736	199	25163	323
23605	132	23922	130	24082	224	24197	227	24737	199	25164	323
23620	132	23923	129	24083	224	24212	414	24738	199	25167	323
23625	132	23924	129	24084	224	24225	414	24739	199	25169	323
23626	132	23925	129	24085	224	24250	414	24740	199	25170	323
23628	132	23927	129	24086	224	24255	414	24741	199	25171	323
23630	132	23928	130	24087	224	24258	414	24743	199	25179	322
23632	132	23945	129	24098	224	24260	414	24745	198	25180	322
23650	134	23950	138	24099	224	24301	225	24746	199	25181	322
23655	134	23951	138	24100	228	24302	225	24747	198	25182	322
23657	135	23952	138	24102	228	24303	225	24748	199	25183	322
23657	278	23953	138	24104	228	24304	225	24749	199	25184	322
23660	134	23954	138	24108	227	24305	225	24750	192	25186	322
23670	131	23955	138	24109	228	24306	225	24751	192	25188	322
23671	131	23960	130	24110	229	24308	226	24752	295	25189	322
23672	131	23961	130	24111	229	24310	226	24753	295	25190	322
23673	131	23962	130	24118	228	24312	226	24755	206	25195	322
23674	131	23963	130	24119	228	24313	226	24756	206	25206	322
23675	131	23964	130	24120	227	24314	227	24757	198	25212	322
23676	131	23965	130	24121	229	24315	226	24758	198	25215	322
23677	131	23966	130	24122	229	24316	226	24759	198	25220	322
23678	131	23967	130	24124	229	24410	192	24760	200	25224	322
23679	131	23970	138	24125	229	24411	192	24761	200	25230	322
23680	131	23971	138	24126	229	24412	192	24762	200	25240	322
23681	131	23972	138	24128	231	24415	207	24763	200	25248	322
23682	131	23973	138	24130	230	24419	192	24764	200	25260	322
23683	131	23974	138	24131	230	24420	192	24765	200	25296	322
23684	131	23975	138	24133	230	24422	192	24766	200	25350	322
23685	131	23976	138	24135	231	24425	192	24767	200	25369	322
23730	441	23977	138	24136	231	24429	192	24768	200	25370	322
23730	139	23978	138	24137	231	24432	192	24769	200	25371	322
23731	441	23979	138	24140	231	24435	192	24770	199	25372	322
23731	139	23985	138	24141	231	24437	192	24771	199	25373	322
23732	441	23986	138	24142	231	24444	192	24772	199	25374	322
23732	139	23987	138	24143	230	24451	192	24773	199	25376	322
23734	441	23988	138	24144	230	24457	192	24774	199	25378	322
23734	139	23989	138	24145	230	24464	192	24776	200	25379	322
23735	441	24000	137	24147	230	24476	192	24778	201	25380	322

Cikkszám	oldal	Cikkszám	oldal	Cikkszám	oldal	Cikkszám	oldal	Cikkszám	oldal	Cikkszám	oldal
25400	323	26963	440	31146	244	31559	249	32318	257	33257	430
25410	323	26972	441	31148	244	31601	255	32319	257	33258	430
26028	44	26973	441	31150	245	31602	255	32320	257	33270	431
26037	49	26974	441	31151	245	31603	255	32321	257	33275	431
26201	46	26975	441	31155	245	31610	249	32322	257	33275	431
26204	46	26976	441	31218	248	31641	255	32323	257	33280	431
26209	47	26977	441	31220	246	31651	255	32324	257	33285	431
26211	47	26979	443	31221	246	31655	255	32325	258	33286	431
26215	44	26985	442	31222	246	32001	252	32326	258	33289	431
26216	45	26986	442	31231	246	32002	252	32327	256	33291	431
26217	45	26988	443	31232	246	32003	252	32328	258	33292	431
26218	45	26996	443	31233	246	32013	252	32329	257	33293	431
26520	48	26997	443	31234	246	32014	252	32330	258	33298	431
26521	48	26998	443	31235	246	32015	252	32331	258	33299	431
26528	49	28000	4	31270	247	32016	252	32332	256	34005	259
26700	438	28001	5	31271	247	32018	252	32333	256	34006	259
26701	438	28002	5	31280	247	32020	252	32335	258	34007	259
26702	438	28003	6	31281	247	32021	252	32337	256	34027	259
26705	438	28004	6	31320	247	32022	255	32338	256	34028	258
26705	326	28005	7	31322	247	32023	255	32418	257	34033	264
26706	438	28006	7	31330	247	32024	252	32421	257	34041	259
26706	326	28007	8	31332	247	32026	252	33100	426	34051	259
26707	438	28008	8	31334	246	32037	255	33102	426	34053	259
26707	326	28021	9	31340	247	32040	255	33105	426	34061	260
26720	438	28025	9	31341	247	32041	255	33107	426	34071	260
26720	326	28030	12	31343	246	32042	255	33110	426	34081	260
26721	438	28032	12	31360	246	32043	255	33112	426	34091	260
26721	326	28035	14	31362	246	32044	255	33113	426	34101	260
26722	438	28040	13	31380	246	32050	255	33114	426	34111	260
26722	326	28045	13	31382	246	32051	255	33120	426	34115	260
26775	297	28050	15	31390	246	32052	255	33123	426	34116	260
26780	304	28055	15	31392	246	32053	255	33124	426	34117	260
26781	304	28065	11	31400	246	32060	252	33127	427	34118	260
26782	304	28070	10	31402	246	32062	252	33131	427	34121	260
26783	304	28080	18	31403	246	32064	252	33132	427	34122	260
26800	434	28081	18	31404	246	32066	252	33135	427	34132	260
26801	434	28085	18	31452	254	32076	252	33137	427	34142	260
26802	434	28086	18	31453	254	32161	251	33140	427	34152	260
26803	434	28101	16	31454	254	32162	251	33141	427	34153	260
26804	434	28102	17	31455	248	32163	251	33142	427	34154	260
26805	434	28103	17	31456	248	32164	251	33143	427	34155	260
26806	434	28104	16	31461	248	32165	251	33150	427	34156	260
26807	434	30003	259	31467	248	32166	251	33151	427	34157	260
26815	434	30003	264	31468	248	32167	251	33152	427	34158	260
26816	434	30004	259	31471	248	32168	251	33154	427	34159	260
26817	434	30004	264	31481	248	32169	251	33155	430	34160	260
26819	434	30005	259	31491	248	32170	248	33160	428	34200	260
26820	435	30005	264	31493	250	32171	251	33162	428	34201	260
26824	435	30007	259	31494	250	32172	251	33163	428	34202	260
26825	435	30007	264	31495	250	32173	248	33164	428	34203	260
26826	435	31005	245	31496	250	32174	251	33165	428	34221	264
26829	436	31006	245	31497	254	32176	251	33167	428	34223	264
26844	435	31007	245	31498	250	32186	251	33168	428	34231	265
26845	435	31008	245	31499	250	32196	251	33168	257	34235	265
26853	436	31009	245	31500	250	32206	251	33169	428	34237	265
26857	436	31011	245	31501	254	32216	251	33170	428	34238	265
26858	436	31021	245	31502	254	32226	251	33200	429	34241	264
26859	436	31031	245	31503	254	32234	251	33201	429	34243	264
26862	436	31041	245	31505	248	32240	251	33202	429	34251	264
26871	437	31051	245	31506	248	32265	253	33203	429	34261	265
26880	437	31052	246	31507	248	32268	253	33205	429	34262	264
26881	437	31053	245	31510	248	32269	253	33206	429	34265	265
26886	437	31061	246	31511	248	32270	253	33207	429	34271	260
26888	437	31062	246	31512	248	32273	253	33208	429	34272	260
26891	441	31071	246	31513	248	32283	253	33209	429	34273	260
26895	439	31072	246	31514	248	32285	253	33210	429	34274	260
26896	439	31081	246	31515	248	32293	253	33211	429	34275	260
26897	439	31082	245	31520	250	32295	253	33212	429	34276	260
26911	440	31091	244	31521	250	32296	253	33215	429	34280	260
26912	440	31101	244	31522	250	32297	253	33220	430	34281	260
26914	440	31111	244	31523	250	32298	253	33221	430	34282	260
26915	440	31121	244	31524	250	32301	253	33246	431	34283	260
26920	438	31131	244	31541	250	32302	253	33247	431	34284	260
26921	438	31132	244	31551	250	32311	257	33248	431	34285	260
26922	438	31140	244	31552	250	32312	256	33249	431	34300	297
26940	439	31141	244	31553	250	32313	253	33250	430	34301	260
26941	439	31142	244	31555	249	32314	257	33252	430	34303	297
26943	439	31143	244	31556	249	32315	258	33254	430	34304	260
26954	440	31144	244	31557	249	32316	258	33255	430	34305	254
26961	440	31145	244	31558	249	32317	256	33256	430	34306	254

Cikkszám	oldal	Cikkszám	oldal	Cikkszám	oldal	Cikkszám	oldal	Cikkszám	oldal	Cikkszám	oldal
34307	254	35081	268	35517	273	37041	255	37204	286	37500	274
34308	254	35082	269	35518	273	37051	255	37205	286	37501	274
34315	219	35085	267	35519	273	37053	284	37205	286	37505	274
34316	172	35086	267	35524	273	37054	284	37210	285	37506	274
34316	219	35087	267	35525	273	37055	284	37211	285	37509	275
34400	262	35091	267	35527	273	37065	290	37212	286	37510	275
34401	262	35092	267	35532	273	37066	290	37216	298	37511	275
34402	263	35093	267	35533	273	37067	290	37217	298	37512	275
34403	263	35094	267	35539	273	37068	290	37218	298	37515	275
34404	262	35095	267	35540	273	37069	290	37220	285	37516	275
34405	262	35096	267	35542	273	37070	290	37229	299	37517	275
34406	263	35103	270	35552	273	37094	290	37230	299	37518	275
34407	263	35113	270	35553	273	37095	290	37231	299	37527	276
34409	262	35123	270	35555	273	37096	290	37232	299	37530	276
34410	262	35125	270	35603	276	37097	290	37233	299	37532	276
34411	263	35126	270	35604	276	37098	290	37234	299	37533	276
34412	263	35127	270	35605	276	37101	255	37235	299	37539	276
34413	263	35300	266	35833	271	37111	255	37236	298	37541	276
34414	264	35310	266	35845	271	37114	298	37237	298	37545	279
34415	262	35311	266	35850	271	37115	298	37238	298	37546	279
34416	262	35316	266	36014	282	37117	283	37239	298	37549	279
34417	263	35317	266	36024	282	37119	298	37243	321	37553	135
34418	263	35318	266	36034	282	37120	298	37244	321	37553	278
34419	262	35319	266	36035	282	37121	304	37245	321	37560	279
34420	262	35320	314	36036	282	37122	304	37246	321	37564	277
34421	263	35322	314	36046	282	37123	421	37247	321	37570	231
34422	263	35323	181	36056	283	37124	421	37248	321	37570	279
34423	263	35323	294	36057	283	37125	288	37250	321	37600	327
34424	263	35325	181	36058	283	37126	288	37251	321	37601	327
34425	262	35325	294	36059	283	37127	288	37252	321	37602	327
34426	262	35326	181	36076	281	37129	421	37253	321	37603	327
34428	263	35326	294	36077	281	37130	287	37255	308	37604	327
34429	264	35327	181	36080	281	37131	287	37256	308	37605	327
34439	262	35327	294	36081	281	37132	287	37257	308	37606	327
34440	262	35328	181	36082	281	37135	443	37258	308	37611	327
34441	262	35328	294	36085	281	37135	154	37259	308	37615	327
34442	262	35329	181	36086	281	37139	154	37263	308	37616	327
34443	262	35329	294	36087	281	37140	154	37264	308	37621	419
34445	262	35330	183	36126	282	37141	154	37266	308	37630	419
34446	262	35330	293	36128	282	37142	154	37267	308	37640	418
34447	262	35331	183	36130	282	37143	154	37268	308	37641	418
34448	263	35331	293	36136	282	37144	154	37270	308	37645	418
34449	262	35332	182	36140	285	37145	154	37271	308	37650	419
34450	262	35332	292	36145	280	37148	286	37272	308	37730	270
34451	262	35333	182	36160	280	37149	286	37273	308	37731	270
34452	263	35333	292	36175	280	37150	286	37275	308	37760	270
34453	262	35334	182	36190	280	37151	286	37280	309	37761	270
34454	262	35334	292	36191	280	37152	286	37281	309	38000	312
34455	263	35335	181	36199	281	37153	286	37290	321	38001	311
34456	263	35335	294	36200	281	37154	286	37291	321	38002	312
34457	263	35336	182	36240	281	37155	286	37295	410	38003	312
34458	263	35336	292	36300	279	37156	286	37295	309	38004	312
34459	264	35345	183	36305	413	37157	286	37296	410	38005	312
34479	264	35345	293	36306	413	37158	286	37296	309	38006	311
34480	262	35346	183	36308	297	37162	288	37297	410	38007	312
34481	262	35346	293	36310	277	37166	277	37297	309	38008	312
34482	262	35347	183	36312	297	37170	288	37300	158	38009	312
34485	262	35347	183	36313	413	37171	288	37301	158	38010	311
34486	262	35347	293	36314	413	37172	288	37302	158	38012	311
34490	263	35347	293	36325	289	37173	288	37303	158	38013	311
34491	263	35348	182	37005	317	37174	288	37308	159	38014	312
34496	263	35348	292	37006	284	37175	288	37309	159	38014	312
34500	264	35360	144	37006	284	37176	288	37310	157	38015	313
35006	268	35361	144	37007	284	37177	289	37311	157	38016	313
35007	268	35362	144	37007	284	37178	289	37317	337	38017	313
35011	270	35500	272	37008	284	37185	288	37320	157	38018	313
35012	268	35501	272	37009	284	37186	288	37321	157	38020	311
35013	268	35502	272	37010	431	37187	288	37325	156	38021	313
35015	269	35503	272	37011	284	37188	288	37326	156	38022	313
35021	269	35504	272	37012	284	37189	288	37328	156	38024	311
35023	267	35505	272	37021	284	37190	288	37330	155	38025	311
35038	267	35506	272	37025	283	37195	286	37331	155	38026	286
35048	269	35507	272	37025	283	37196	286	37332	155	38026	314
35058	267	35508	272	37026	283	37197	286	37340	159	38027	310
35059	268	35510	272	37026	283	37198	286	37341	158	38028	310
35068	269	35511	272	37028	283	37199	287	37342	158	38030	314
35069	268	35512	272	37028	283	37200	286	37343	159	38031	313
35070	269	35514	273	37029	283	37201	286	37344	159	38042	286
35078	268	35515	273	37029	283	37202	286	37345	159	38042	314
35079	269	35516	273	37031	255	37203	286	37350	157	38050	305

Cikkszám	oldal	Cikkszám	oldal	Cikkszám	oldal	Cikkszám	oldal	Cikkszám	oldal	Cikkszám	oldal
38052	305	38980	307	41120	387	42368	305	45019	336	45096	333
38054	305	38981	307	41121	387	42420	296	45020	332	45097	333
38055	305	38985	309	41122	387	43050	395	45021	336	45098	333
38060	305	38990	307	41123	387	43058	396	45023	332	45099	333
38063	305	38991	307	41150	387	43060	396	45025	336	45100	364
38065	305	38995	308	41151	387	43068	396	45026	335	45101	364
38095	305	39000	304	41152	387	43071	395	45027	336	45102	364
38096	305	39001	304	41153	387	43072	395	45029	336	45104	364
38097	305	39002	304	42101	387	43077	395	45030	232	45105	364
38895	291	39003	304	42102	387	43082	396	45030	339	45106	364
38896	291	39005	304	42103	387	43083	396	45031	232	45107	364
38899	291	39010	304	42115	299	43084	396	45031	339	45108	364
38900	291	39012	304	42120	299	43086	396	45032	232	45110	352
38901	291	39014	304	42150	389	43087	397	45032	339	45111	352
38902	291	39020	304	42151	389	43089	397	45033	232	45112	353
38903	291	39021	304	42152	389	43090	397	45033	339	45113	352
38904	291	39045	304	42153	389	43097	396	45034	342	45114	352
38905	291	39065	304	42155	389	43098	397	45035	341	45115	352
38906	291	39090	304	42156	389	43099	397	45036	345	45116	352
38907	291	39145	304	42157	389	43300	385	45038	342	45117	351
38908	291	39165	304	42158	389	43301	385	45039	342	45118	351
38909	291	39190	304	42160	389	44041	345	45040	342	45120	352
38910	291	39192	304	42161	389	44042	345	45041	342	45122	352
38911	291	39192	347	42162	389	44043	345	45042	347	45123	351
38912	291	39193	304	42163	389	44050	345	45043	344	45124	351
38913	291	39193	347	42170	389	44053	347	45044	345	45125	351
38914	291	39194	305	42171	389	44950	176	45045	177	45126	351
38915	291	39195	305	42172	389	44950	340	45045	344	45130	355
38916	291	39196	305	42173	389	44955	342	45046	177	45131	355
38917	291	39197	305	42174	389	44960	347	45046	344	45132	355
38918	291	39198	305	42175	389	44965	368	45047	347	45133	356
38919	285	39199	305	42176	389	44970	336	45048	177	45134	353
38920	285	39200	305	42177	389	44971	336	45048	335	45135	355
38923	285	39201	305	42178	389	44972	332	45048	344	45136	356
38924	307	39202	305	42179	389	44980	332	45049	345	45137	356
38925	307	39203	305	42180	389	44980	332	45050	368	45138	354
38926	309	39204	305	42181	389	44980	334	45051	369	45139	354
38927	307	39205	305	42182	389	44981	332	45052	369	45140	353
38928	308	39206	295	42185	389	44981	332	45053	370	45141	354
38929	307	39207	295	42186	389	44981	333	45054	370	45142	353
38930	309	39208	295	42187	389	44981	334	45055	369	45143	354
38931	307	39210	295	42188	389	44982	333	45056	341	45144	355
38932	307	39212	295	42190	306	44982	333	45057	341	45145	355
38933	309	39214	295	42190	389	44982	334	45058	341	45146	357
38934	308	39216	295	42201	390	44983	333	45059	341	45147	358
38935	309	39217	295	42202	390	44983	333	45060	232	45150	358
38937	309	39218	295	42203	390	44983	334	45060	339	45151	359
38939	309	39219	295	42207	390	44984	334	45061	232	45152	357
38940	309	39238	296	42208	390	44984	335	45061	339	45153	357
38941	309	39240	295	42209	390	44984	335	45062	232	45154	357
38942	308	39241	295	42210	390	44985	334	45062	339	45155	358
38943	309	39242	295	42211	390	44985	335	45063	332	45156	358
38944	306	39243	295	42212	390	44986	334	45065	341	45158	358
38945	306	39244	295	42213	390	44987	334	45066	341	45159	359
38946	306	39245	296	42214	390	44988	334	45067	341	45160	358
38947	306	40050	388	42217	390	44989	334	45068	177	45161	359
38948	306	40051	388	42218	390	44991	334	45068	335	45162	357
38949	306	40052	388	42219	390	44992	334	45068	344	45163	358
38950	296	40053	388	42220	390	44995	338	45069	176	45164	359
38951	296	40054	388	42221	390	44996	334	45069	340	45167	358
38952	296	40055	388	42228	390	44997	335	45070	370	45168	359
38953	296	40056	388	42229	390	44998	335	45071	369	45169	359
38954	296	40057	388	42230	390	44999	337	45074	346	45170	361
38955	306	40058	388	42240	390	45000	337	45079	342	45171	361
38956	306	40059	388	42244	390	45001	337	45080	342	45172	361
38957	306	40060	388	42248	390	45002	338	45081	176	45172	361
38958	306	40075	388	42249	390	45003	338	45081	340	45173	361
38959	306	40076	388	42251	390	45005	338	45082	176	45173	361
38960	306	40077	388	42252	390	45006	338	45082	340	45174	361
38961	306	40100	387	42253	390	45007	338	45083	176	45175	360
38963	309	40120	387	42255	390	45008	338	45083	340	45176	360
38964	307	41050	387	42256	390	45009	338	45084	176	45177	360
38965	308	41080	387	42257	390	45010	335	45084	340	45178	360
38966	307	41081	387	42260	391	45011	337	45085	347	45179	359
38968	307	41082	387	42261	391	45012	337	45086	346	45180	353
38969	309	41083	387	42312	296	45014	335	45088	333	45181	353
38970	296	41100	387	42312	390	45015	337	45089	333	45182	360
38971	296	41101	387	42365	305	45016	336	45093	347	45183	360
38972	309	41102	387	42366	305	45017	334	45094	334	45184	359
38973	309	41103	387	42367	305	45018	335	45095	333	45185	359

Cikkszám	oldal	Cikkszám	oldal	Cikkszám	oldal	Cikkszám	oldal	Cikkszám	oldal	Cikkszám	oldal
45186	359	45296	353	45520	343	45651	345	48415	328	50541	153
45187	360	45297	354	45521	343	45652	345	48420	328	50542	153
45190	362	45298	353	45522	343	45653	345	48452	328	50544	153
45191	362	45299	354	45523	343	45654	345	48453	328	50549	152
45192	362	45300	361	45524	343	45655	345	48454	328	50550	150
45193	362	45301	361	45525	343	45656	345	48455	328	50551	150
45194	362	45320	369	45526	343	45657	345	48456	328	50553	150
45195	362	45321	370	45527	343	45658	345	48457	328	50554	150
45196	362	45323	368	45528	343	45659	345	48719	279	50555	153
45197	362	45323	382	45529	343	45660	345	48729	277	50556	150
45198	362	45325	368	45530	343	45661	345	48730	277	50557	152
45199	362	45326	368	45531	343	45662	345	48731	277	50558	152
45200	362	45327	367	45532	343	45663	345	50004	414	50559	150
45203	363	45328	367	45533	343	45664	345	50005	414	50560	150
45204	363	45329	367	45534	343	45670	345	50009	415	50562	150
45206	362	45330	385	45535	346	45671	345	50010	415	50563	150
45211	363	45331	385	45540	346	45672	345	50011	415	50564	150
45213	355	45345	361	45541	346	45673	345	50012	415	50570	150
45214	357	45349	361	45542	346	48001	145	50013	415	50571	150
45215	356	45350	361	45543	346	48002	145	50014	415	50585	153
45216	357	45353	361	45550	346	48005	146	50015	415	50585	321
45217	357	45360	361	45551	346	48006	146	50017	417	50586	153
45218	356	45364	361	45552	346	48007	146	50019	417	50586	321
45219	356	45366	361	45553	346	48008	147	50020	417	50587	153
45220	363	45370	177	45555	346	48009	147	50021	417	50587	321
45221	363	45370	344	45556	346	48010	147	50022	417	50588	153
45222	363	45385	348	45557	346	48015	145	50025	417	50588	321
45223	363	45386	348	45558	346	48020	146	50026	417	50900	409
45224	363	45388	348	45559	346	48021	146	50030	391	50901	409
45225	363	45389	348	45560	345	48022	146	50031	391	50902	409
45226	363	45390	349	45562	346	48030	146	50032	391	50905	409
45227	363	45391	349	45563	346	48031	147	50033	391	50906	409
45228	363	45392	349	45564	346	48032	147	50035	443	50907	409
45229	363	45393	349	45565	346	48033	147	50035	391	50909	409
45239	366	45394	349	45570	389	48034	147	50036	443	50910	409
45240	366	45395	349	45571	389	48036	145	50036	391	50911	409
45241	366	45396	349	45572	389	48037	146	50037	391	50915	409
45242	366	45397	349	45573	389	48040	147	50038	391	50916	409
45244	365	45398	350	45580	390	48041	147	50040	391	50917	409
45245	365	45399	350	45600	363	48042	147	50041	391	50918	409
45246	365	45400	350	45601	363	48043	147	50042	391	50919	409
45247	365	45401	350	45602	363	48046	146	50050	305	50920	409
45248	365	45450	394	45603	363	48046	147	50050	305	51001	408
45249	365	45451	394	45604	363	48047	146	50051	305	51002	408
45250	365	45452	394	45605	363	48047	147	50052	305	51003	408
45251	365	45453	394	45606	363	48050	148	50052	305	51004	408
45253	365	45460	394	45607	363	48051	148	50100	324	51007	408
45254	365	45461	394	45608	363	48054	148	50101	324	51008	408
45256	365	45462	394	45609	363	48055	148	50102	324	51009	408
45257	365	45463	394	45610	363	48056	148	50103	324	51010	408
45260	365	45465	394	45611	363	48057	148	50104	324	51011	408
45261	365	45466	394	45612	363	48060	148	50106	324	51013	407
45262	365	45467	394	45613	363	48061	148	50108	324	51015	408
45262	366	45470	394	45614	363	48062	148	50500	151	51017	407
45263	365	45471	309	45615	363	48063	148	50501	151	51018	407
45263	366	45471	344	45616	363	48064	148	50502	151	51020	407
45265	366	45472	344	45617	363	48065	148	50503	151	51022	407
45266	366	45473	344	45618	363	48066	148	50505	151	51023	407
45267	365	45480	394	45619	363	48067	148	50510	149	51026	406
45267	366	45485	394	45620	363	48068	148	50511	149	51030	407
45268	365	45490	380	45621	363	48070	148	50512	149	51032	407
45268	366	45496	394	45622	363	48071	148	50513	149	51034	407
45269	366	45497	394	45623	363	48072	148	50514	149	51036	408
45270	365	45498	394	45624	363	48075	148	50518	151	51037	408
45271	365	45499	394	45625	363	48076	148	50519	151	51038	409
45272	365	45500	343	45626	363	48077	148	50520	151	51040	406
45273	365	45502	343	45627	363	48080	148	50521	151	51041	406
45274	365	45503	343	45628	363	48081	148	50522	152	51042	406
45280	364	45505	343	45629	363	48085	148	50523	151	51043	406
45283	364	45506	343	45630	363	48086	148	50524	151	51045	407
45285	364	45508	343	45631	363	48087	148	50525	152	51046	407
45286	364	45509	343	45632	363	48090	148	50526	152	51050	409
45287	364	45511	343	45633	363	48091	148	50527	153	51051	409
45289	355	45512	343	45634	363	48093	148	50529	152	51055	409
45290	355	45513	343	45635	363	48094	148	50531	152	51056	409
45291	355	45515	343	45636	363	48095	148	50532	153	51057	409
45292	356	45516	343	45637	363	48096	148	50533	152	51060	406
45293	356	45517	343	45638	363	48097	148	50537	152	51065	406
45294	354	45518	343	45639	363	48410	328	50539	152	51070	406
45295	354	45519	343	45650	345	48411	328	50540	153	51071	406



Cikkszám	oldal	Cikkszám	oldal	Cikkszám	oldal	Cikkszám	oldal	Cikkszám	oldal	Cikkszám	oldal
51072	406	51288	325	52125	385	55041	143	55465	392	61077	380
51100	326	51300	324	52126	385	55050	143	55640	329	61079	380
51101	326	51301	324	52130	285	55051	143	55642	329	61085	342
51102	326	51302	324	52160	382	55060	143	55645	329	61088	374
51103	326	51303	324	52161	382	55080	143	60001	384	61089	373
51104	326	51304	324	52162	382	55100	143	60006	384	61090	374
51105	326	51305	324	52163	382	55120	143	60008	384	61097	376
51106	326	51306	324	52164	382	55140	143	60012	384	61098	376
51107	326	51307	324	52168	381	55160	143	60018	385	61111	378
51108	326	51308	324	52173	381	55180	143	60019	385	61112	378
51109	326	51320	324	52175	381	55181	143	60020	385	61114	378
51110	326	51321	324	52176	381	55200	143	60022	385	61120	378
51111	326	51322	324	52185	382	55201	143	60100	253	61121	378
51120	326	51323	324	52186	382	55220	143	60115	277	61130	369
51121	326	51324	324	52187	382	55221	143	60116	277	61131	369
51122	326	51325	324	52188	382	55240	143	60117	277	61132	369
51123	326	51327	324	52189	382	55300	143	60118	277	61133	369
51124	326	51338	326	52190	382	55301	143	60121	277	61134	370
51125	326	51341	326	52191	382	55311	143	60123	277	61135	370
51126	326	51348	326	52192	382	55313	143	60201	384	61136	367
51127	326	51402	325	52193	382	55314	143	60206	384	61137	367
51130	326	51403	325	52194	382	55315	143	60208	384	61138	367
51131	326	51404	325	52195	383	55316	143	60212	384	61139	368
51132	326	51405	325	52196	383	55317	143	61000	374	61140	368
51181	415	51406	325	52197	382	55318	143	61001	374	61141	370
51182	415	51407	325	52198	381	55319	143	61002	375	61142	370
51187	409	51408	325	52202	316	55331	143	61003	376	61143	371
51196	326	51410	325	52203	316	55332	143	61004	375	61144	371
51197	326	51412	325	52204	316	55333	143	61005	372	61145	371
51198	326	51413	325	52205	316	55334	143	61006	372	61146	371
51199	326	51414	325	52206	316	55335	143	61007	373	61147	367
51200	409	51415	325	52207	316	55336	143	61008	372	61148	367
51201	409	51416	325	52208	316	55337	143	61009	377	61149	368
51202	409	51417	325	52212	316	55339	143	61010	373	61149	382
51203	409	51418	325	52213	316	55340	143	61012	377	61150	369
51204	324	51420	325	52214	316	55341	143	61013	376	61155	372
51205	324	51430	325	52215	316	55342	143	61014	377	61156	372
51206	324	51431	325	52216	316	55350	143	61015	373	61157	372
51207	324	51432	325	52217	316	55351	143	61018	376	61158	372
51208	324	51433	325	52218	316	55352	143	61019	376	61161	375
51209	324	51435	325	52220	316	55353	143	61020	374	61162	376
51210	324	51436	325	52283	316	55354	143	61021	373	61163	376
51211	324	51450	325	52284	316	55355	143	61022	374	61164	377
51212	324	51510	403	52285	316	55356	143	61024	375	61165	377
51220	325	51511	403	52286	316	55357	143	61025	373	61166	377
51221	325	51512	403	52288	316	55358	143	61026	373	61169	253
51222	325	51513	403	52305	319	55359	143	61028	377	61171	385
51225	325	51514	403	52306	319	55360	143	61029	373	61172	382
51226	325	51515	403	52315	319	55361	143	61030	371	61172	385
51227	325	51516	403	52328	319	55362	143	61031	371	61173	385
51241	324	51517	403	52331	319	55400	392	61032	371	61174	385
51242	324	52010	416	52334	319	55401	392	61033	371	61175	385
51243	324	52011	249	52391	319	55402	392	61034	371	61176	385
51244	324	52011	320	52421	319	55403	392	61035	378	61177	385
51245	324	52012	416	52424	319	55404	392	61036	378	61183	386
51246	324	52020	416	52428	319	55405	392	61038	378	61184	386
51247	324	52030	416	52456	319	55406	392	61040	378	61189	386
51257	326	52030	260	52471	319	55420	392	61042	378	61190	386
51258	326	52050	328	52600	318	55421	392	61044	377	61192	385
51259	326	52055	328	52601	318	55422	392	61045	371	61193	385
51260	326	52060	328	52602	318	55423	392	61046	371	61194	385
51261	326	52065	328	52605	318	55424	392	61047	371	61195	386
51262	326	52070	316	52610	318	55425	392	61048	371	61200	385
51263	326	52071	317	52611	297	55429	392	61050	374	61201	385
51264	326	52075	317	52612	297	55430	392	61051	374	61201	385
51265	326	52076	317	52620	321	55431	392	61052	375	61202	386
51271	324	52077	317	52625	321	55432	392	61053	374	61203	377
51272	324	52078	317	52630	321	55433	392	61054	375	61204	386
51273	324	52101	382	52635	321	55436	392	61056	373	61205	386
51274	324	52102	382	52640	321	55437	392	61057	373	61207	386
51275	324	52103	382	52645	321	55450	393	61058	375	61208	386
51276	324	52104	382	52652	321	55452	393	61059	375	61209	377
51278	324	52105	382	52656	321	55453	393	61060	371	61215	386
51280	325	52108	382	52662	320	55454	393	61061	371	61218	253
51281	325	52109	383	52666	320	55455	393	61062	371	61219	386
51282	325	52113	383	52671	320	55456	393	61063	371	61221	379
51283	325	52114	383	52694	320	55457	393	61067	379	61221	379
51284	325	52115	383	52695	320	55460	393	61068	379	61221	379
51286	325	52116	383	54008	321	55461	393	61069	379	61221	379
51287	325	52119	381	55040	143	55462	393	61070	379	61222	377

Cikkszám oldal	Cikkszám oldal	Cikkszám oldal	Cikkszám oldal	Cikkszám oldal	Cikkszám oldal						
61223	376	70036	140	81152	424	81267	423	81348	423	81430	423
61224	378	70037	140	81155	424	81268	423	81349	423	81431	423
61224	378	70038	140	81160	425	81269	423	81350	423	81432	423
61230	386	70040	140	81165	425	81270	423	81351	423	81433	423
61235	416	70045	140	81170	424	81271	423	81352	423	81434	423
61240	118	70046	140	81175	425	81272	423	81353	423	81435	423
61250	386	70060	141	81178	425	81273	423	81354	423	81436	423
61251	347	70061	141	81180	425	81274	423	81355	423	81437	423
61251	386	70062	141	81185	424	81275	423	81356	423	81438	423
61252	386	70063	141	81186	424	81276	423	81357	423	81439	423
61253	386	70064	141	81189	424	81277	423	81358	423	81440	423
61254	386	70065	142	81190	425	81278	423	81359	423	81441	423
61255	386	70066	141	81191	425	81279	423	81360	423	81442	423
61256	386	70070	142	81200	423	81280	423	81361	423	81443	423
61290	379	70075	142	81201	423	81281	423	81362	423	81444	423
61291	379	70090	142	81202	423	81282	423	81363	423	81445	423
61292	379	70091	142	81203	423	81284	423	81364	423	81447	423
61293	379	70092	142	81204	423	81285	423	81365	423	81448	423
61294	379	70093	142	81205	423	81286	423	81366	423	81449	423
61295	379	70094	142	81206	423	81287	423	81367	423	81450	423
61296	379	70095	142	81207	423	81288	423	81370	423	81451	423
61297	379	70096	142	81208	423	81289	423	81371	423	81452	423
61299	393	70098	92	81209	423	81290	423	81372	423	81453	423
61300	393	70100	405	81210	423	81291	423	81373	423	81454	423
61301	393	70101	405	81211	423	81292	423	81374	423	81455	423
61302	393	70102	405	81212	423	81293	423	81375	423	81456	423
61320	119	70103	405	81213	423	81294	423	81376	423	81457	423
61321	119	70104	405	81214	423	81295	423	81377	423	81458	423
61322	119	70105	405	81215	423	81296	423	81378	423	81459	423
61323	119	70106	405	81216	423	81297	423	81379	423	81460	423
61324	119	70107	405	81217	423	81298	423	81380	423	81461	423
61325	119	70108	405	81218	423	81299	423	81381	423	81462	423
61326	119	70109	405	81219	423	81300	423	81382	423	81463	423
61327	119	70110	405	81220	423	81301	423	81383	423	81466	423
61328	119	70120	404	81221	423	81302	423	81384	423	81467	423
61329	119	70121	404	81222	423	81303	423	81385	423	81468	423
61330	119	70122	404	81223	423	81304	423	81386	423	81469	423
61331	119	70123	404	81224	423	81305	423	81387	423	81470	423
61340	123	70124	404	81225	423	81306	423	81388	423	81471	423
61341	123	70125	404	81226	423	81307	423	81389	423	81472	423
61342	123	70140	404	81227	423	81308	423	81390	423	81473	423
61343	123	70141	404	81228	423	81309	423	81391	423	81486	423
61344	123	70220	414	81229	423	81310	423	81392	423	81600	421
61345	123	70221	414	81230	423	81311	423	81393	423	81603	421
61346	123	81011	422	81231	423	81312	423	81394	423	82105	299
65062	329	81011A	422	81232	423	81313	423	81395	423	89970	411
65063	329	81011F	422	81233	423	81314	423	81396	423	89970	315
65064	329	81011G	422	81234	423	81315	423	81397	423	89973	411
65065	329	81011H	422	81235	423	81316	423	81398	423	89973	315
69900	301	81011R	422	81236	423	81317	423	81399	423	89975	411
69901	301	81012	422	81237	423	81318	423	81400	423	89975	315
69902	301	81013	422	81238	423	81319	423	81401	423	89980	411
69903	301	81014	422	81239	423	81320	423	81402	423	89980	315
69904	300	81015	422	81240	423	81321	423	81403	423	89985	411
69905	301	81016	422	81241	423	81322	423	81404	423	89985	315
69906	301	81022	422	81242	423	81323	423	81405	423	89987	411
69907	303	81023	422	81243	423	81324	423	81406	423	89987	315
69908	303	81024	422	81244	423	81325	423	81407	423	89988	411
69909	303	81025	422	81245	423	81326	423	81408	423	89988	315
69910	302	81035	422	81246	423	81327	423	81409	423	89989	411
69911	302	81036	422	81247	423	81328	423	81410	423	89989	315
69912	302	81053	420	81248	423	81329	423	81411	423	89990	411
69914	301	81054	420	81249	423	81330	423	81412	423	89990	315
69917	302	81056	420	81250	423	81331	423	81413	423	90070	283
69918	300	81057	420	81251	423	81332	423	81414	423	90071	283
69919	300	81070	420	81252	423	81333	423	81415	423	90072	283
69920	303	81071	420	81253	423	81334	423	81416	423	90191	185
69923	303	81072	420	81254	423	81335	423	81417	423	90192	186
69928	303	81074	420	81255	423	81336	423	81418	423		
69930	302	81075	420	81256	423	81337	423	81419	423		
69931	302	81077	420	81257	423	81338	423	81420	423		
70020	140	81100	420	81258	423	81339	423	81421	423		
70021	140	81101	420	81259	423	81340	423	81422	423		
70025	140	81102	420	81260	423	81341	423	81423	423		
70026	140	81103	420	81261	423	81342	423	81424	423		
70030	140	81104	420	81262	423	81343	423	81425	423		
70031	140	81105	420	81263	423	81344	423	81426	423		
70032	140	81106	420	81264	423	81345	423	81427	423		
70033	140	81150	424	81265	423	81346	423	81428	423		
70035	140	81151	424	81266	423	81347	423	81429	423		

# ALKALMAZOTT PIKTOGRAMOK LISTÁJA

## • TERMÉKLEÍRÁS

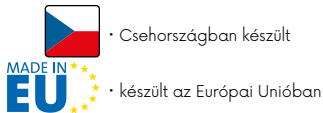

## ALKALMAZÁSI ELŐÍRÁSOK

- fa ·
- kerámia ·
- muanyag ·
- alumínium ·
- réz ·
- kő ·
- üveg ·
- kömvés ·
- papír ·
- acél ·
- összetett ·
- csempé ·
- rozsdamentes acél ·
- vakolat ·
- fa csavarral, szögek ·
- gipszkarton ·
- anyagok fúrására ...  
-ig húzószilárdságig ... ·

- S2** · acél S2
- HSS** · nagysebességű acélvágó
- Cr-Mo** · króm-molibdén acél
- CrV** · króm-vanádium acél
- INOX** · rozsdamentes acél
- NYLON** · nylon fogantyú
- TEFLON** · teflon felület
- Zn** · horganyzott felület
- TiN** · titán-nitrid bevonatú felület
- HRC 58-61** · HRC - anyag keménysége
- 40% PES** · az anyag százalékos összetétele - 40% poliészter
- PES** · 100% poliészter
- gyémánt felületi felület
- a termék vagy annak valamely része mágneses

- SDS+** **SDS MAX** **M14** · szerelési módszer
- a fogak száma a racsos villás kulcsban
- 1/2"** **3/4"** **1/4"** · racsos
- 27 dB** · Információ a hangvédelemről
- DIN 3113** **IP 54** · alapértelmezett
- 32x** · darabszám darabban
- II. class** **III. class** · pontossági osztály
- hideg időre alkalmas
- ERGO HANDLE** · ergonomikus fogantyú
- HOBBY** · hobbi
- 2x AAA** · típusát és az akkumulátorok számát
- UV STABLE** · UV stabil
- RUBBER ENDS** · ütközésgátló gumi végek



## • CSOMAGOLÁSI INFORMÁCIÓK

- dobozba csomagolva
- euroslot
- MOQ 12** · Minimális rendelési mennyiség
- darabszám a csomagban

## ALKALMAZOTT PIKTOGRAMOK LISTÁJA - FESTA AQUATIC, ROSA

állítható permetezési minták ·

- minimális és maximális nyomás ·
- maximális vízáram ·
- öntözött terület ·
- adapter menete mérete ·
- tömlő átmérője ·



20  
23  
24



PROFI X SZERSZÁMOK



festatools



#festatools



festatools

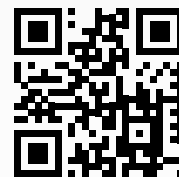

[www.festa.tools](http://www.festa.tools)

HORIZONT.

FESTA  
POWER X TOOLS

FESTA  
AQUATIC

ROSA KOMELON®

KDS®

Stahlberg

SUPER PRO

Lescha

