

FESTA®

PROFI X SZERSZÁMOK



ÚJ TERMÉKEK

forgási sebesség
0-850 min⁻¹

BPM / Ütőenergia
0-4500 / 6 J

teljesítmény
1500 W

tokmány
SDS+

mélységi stop



MAX Ø
beton - Ø 32 mm
fémek - Ø 13 mm
erdő - Ø 40 mm



rezgés csökkentő

ergonomikus
gumírozott
fogantyú a
kényelmes és
biztos fogásért

SDS+
tokmány

kiegészítő fogantyú



2.0m

FESTA
POWER X TOOLS

ÜTVEFÚRÓ

A készlet tartalma:

- ütvefúró
- oldalsó fogantyú
- nyomtáv mélység
- csavarkulcs
- műanyag tok
- tartalék szénkefék
- SDS+ tartozékok:

Ø 8, 10, 12 x 160 mm

20 x 250 mm

14 x 250 mm



2db tartalék
szénkefe

- 28228



230V
~ 50Hz

1500W



28225

leírás



forgási sebesség
0-1350 min⁻¹

BPM / Ütőenergia
0-5500 / 2,8 J

teljesítmény
800 W

tokmány
SDS+
ø 2 - 13 mm



MAX ø
beton - ø 25 mm
fémek - ø 13 mm
erdő - ø 30 mm



FESTA
POWER X TOOLS

ÜTVEFÚRÓ

A készlet tartalma:

- ütvefúró
- oldalsó fogantyú
- nyomtáv mélység
- tokmány ø 2 - 13 mm
- műanyag tok
- vazelin
- tartalék szénkefék
- SDS+ tartozékok:

ø 6, 8, 10 x 160 mm

20 x 250 mm

14 x 250 mm



2db tartalék szénkefe - 28223



R.sz. leírás
28220

forgási sebesség
0-4500 min⁻¹

súly
4,3 kg

teljesítmény
1400 W

fűrész tárcsa
max. átmérő
max ø 185 mm / ø 20 mm



max. 63 mm



ergonomikus gumírozott fogantyú a kényelmes és biztos fogásért



max. 45°
oldalsó vezető
6 - 120 mm

porelszívás ø 35 mm

2.0m

FESTA
POWER X TOOLS

KÖRFŰRÉS

A készlet tartalma:

- körfűrész
- oldalsó vezető
- csavarkulcs
- tartalék szénkefék
- fűrészlap ø 185 x 2,3/1,3 x 20 mm 24T (22316)



2db tartalék szénkefe

- 28233



28230

leírás

4

sebesség
teher nélkül
6600 min⁻¹

súly
5,8 kg

teljesítmény
2400 W

maximális
korong átmérő
M14
max ø 230 mm



ergonomikus
gumírozott
fogantyú a
kényelmes és
biztos fogásért

SOFT START

Soft start rendszer



védőborítás



FESTA
POWER X TOOLS

SAROKCSISZOLÓ

A készlet tartalma:

- sarokcsiszoló
- védőburkolat
- oldalsó fogantyú
- csavarkulcs
- tartalék szénkefék



2db tartalék
szénkefe

- 28218



R.sz. leírás
28215



sebesség
teher nélkül
11000 min⁻¹

súly
2 kg

teljesítmény
900 W

maximális
korong átmérő
M14
max ø 125 mm

kiegészítő fogantyú



SOFT START
Soft start rendszer

működtető kapcsoló



2.0m

védőborítás

FESTA
POWER X TOOLS

SAROKCSISZOLÓ

A készlet tartalma:

- sarokcsiszoló
- védőburkolat
- oldalsó fogantyú
- csavarkulcs
- tartalék szénkefék

900 W	230 V ~ 50 Hz	11000 min⁻¹	M14	max ø 125 mm	2.0 m RUBBER	2.0				2db tartalék szénkefe	- 28213		
--------------	-------------------------	-------------------------------	------------	---------------------	------------------------	------------	--	--	--	-----------------------	---------	--	--

R.sz. leírás

28210

8

FESTA
POWER X TOOLS

TARTALÉK SZÉNKEFÉK

2x



R.sz.	leírás	
28228	alkalmas 28225	1
28223	alkalmas 28220	1
28233	alkalmas 28230	1
28213	alkalmas 28210	1
28218	alkalmas 28215	1

max. nyomás
8,2 bar

nyomásmérő
psi, bar,
kgf/cm², kPa

tömlő
600 mm

feszültség
20 V

háttérvilágítású
manométer kijelző



ergonomikus
gumírozott
fogantyú a
kényelmes és
biztos fogásért

gyorskioldó
tokmány a
gumiabroncsok
felfújásához

autó akkumulátor
adapter
3 m

tömlő
Ø 10,5 x 600 mm



adapterek

A készlet tartalma:
- kompresszor
- hálózati adapter az autó akkumulátoráról
- 3x felfújó adapter

LED lámpa

FESTA
POWER X TOOLS

LÉGKOMPRESSZOR

SHARE
20V
Li-ion
technology

ajánlott kiegészítők

2 Ah - 28080

akkumulátor* 4 Ah - 28081

8 Ah - 28083

2,4 A - 28085

töltő*

4,0 A - 28086



*akkumulátor nem tartozék

R.sz. leírás
28075



szívás
kapacitás
60 kg

rezgés
12 beállítási fokozat,
3500 - 8500 r/min

súly
3 kg

feszültség
20 V

megvilágított kijelző



reteszelő kar



ergonomikus
gumírozott
fogantyú a
kényelmes és
biztos fogásért



tapadókorong
Ø 125 mm

FESTA
POWER X TOOLS

CSEMPEVIBRÁTOR

SHARE
20V
Li-ion
technology

ajánlott kiegészítők

2 Ah - 28080
akkumulátor* 4 Ah - 28081
8 Ah - 28083
2,4 A - 28085
töltő* 4,0 A - 28086



A készlet tartalma:
- csempevibrátor
- akkumulátor 2,0 Ah (csak 36328)
- töltő (csak 36328)
- tok

R.sz.	leírás	
36328	2Ah akkumulátorral és töltővel	1
36329	akkumulátor és töltő nélkül	1



1

1

tuner
DAB+ / FM / BT

teljesítmény
2x 15 W

vízállóság
IP54

feszültség
20 V



USB 5V töltéshez



SHARE
tápfeszültség **20V**

FM antenna



színes kijelző

AUX IN jack 3,5 mm

FESTA
POWER X TOOLS

RADIO DAB+ / FM / BT

- sztereó
- DAB+ / FM
- külső bemenet Bluetooth V5.0 / AUX IN 3,5 mm-es jack
- vízállóság IP54
- 30 előre beállított memória (30 DAB / 30 FM)
- USB a töltéshez
- 2,4" színes kijelző
- teljesítmény 2x 15 W
- 20 V / 1,3 A
- adapter

sztereó hangszórók



tápegység - 230V adapter



SHARE
20V
Li-ion
technology

ajánlott kiegészítők

- 2 Ah - 28080
- akkumulátor* 4 Ah - 28081
- 8 Ah - 28083
- 2,4 A - 28085
- töltő* 4,0 A - 28086



*akkumulátor nem tartozék

R.sz. leírás
28076



állítható sebesség
0-8,7 mm/s

súly
1,7 kg

nyomaték
6500 N

feszültség
20 V



űrtartalom 310 ml

sima sebesség
beállítás

LED lámpa

ergonomikus
gumírozott
fogantyú a
kényelmes és
biztos fogásért



FESTA
POWER X TOOLS

KINYOMÓPISZTOLY

SHARE
20V
Li-ion
technology

ajánlott kiegészítők

2 Ah - 28080

akkumulátor* 4 Ah - 28081

8 Ah - 28083

töltő*

2,4 A - 28085

4,0 A - 28086



*akkumulátor nem tartozék

R.sz. leírás
28060



1

akkumulátor
töltésjelző



FESTA
POWER X TOOLS

AKKUMULÁTOR 20 V | 8,0 Ah

SHARE
20V
Li-ion
technology

20V **8,0 Ah** **Li-ion** **1,0 kg**

R.sz. leírás
28083



1



FESTA

KÖRFÚRÉSZ TÁRCSA,
VIDIA LAPPAL TCT

for 28230

FESTA
POWER X TOOLS



R.sz. leírás
22316

Ø 185 mm x 2,3 mm / 1,3 x Ø 20 mm 24T



1

FESTA

OSZCILLÁLÓ MULTI-TOOL TARTOZÉKKÉSZLET

for 28045

FESTA
POWER X TOOLS



4x

3x BI-METAL



1x SK5

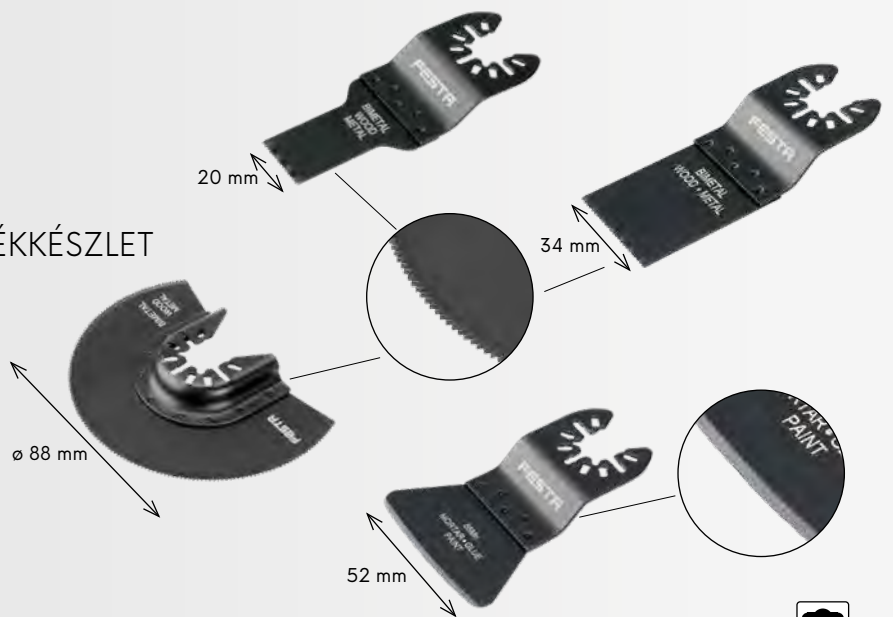

R.sz. leírás

24322

10

FESTA

OSZCILLÁLÓ MULTI-TOOL TARTOZÉKKÉSZLET

for 28045

FESTA
POWER X TOOLS



4x

3x CARBIDE



1x

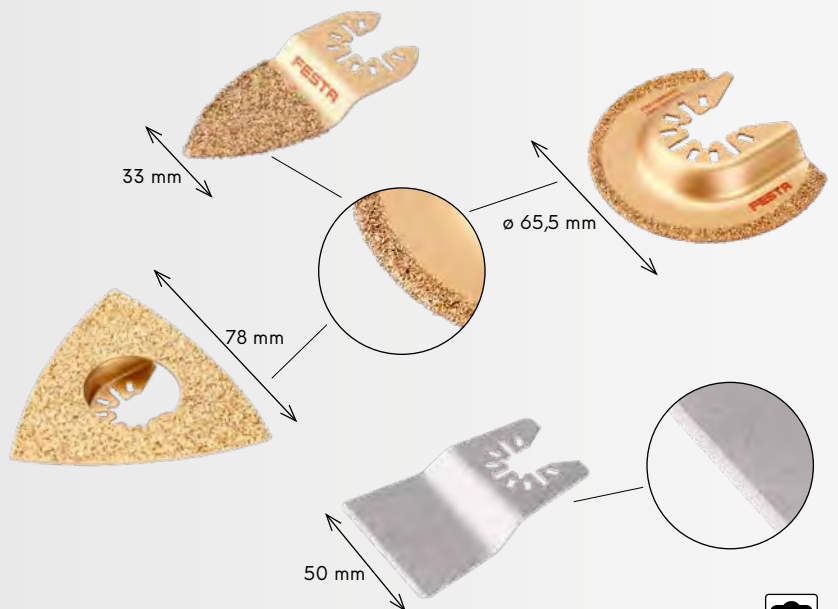

R.sz. leírás

24321

10

OSZCILLÁLÓ MULTI-TOOL TARTOZÉKKÉSZLET

for 28045

FESTA
POWER X TOOLS



3x

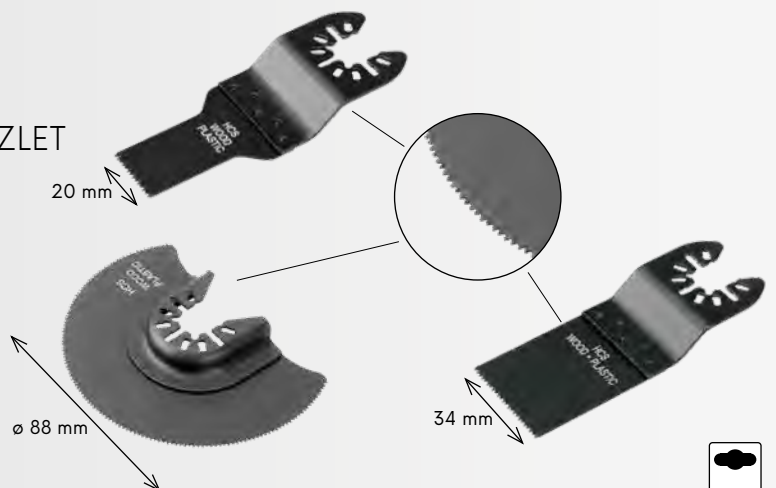

R.sz. leírás

24320

10



FESTA

FESZÜLTÉGVIZSGÁLÓ

- AC / DC - 6 V, 12 V, 24 V, 50 V, 120 V, 230 V, 400 V
- vízállóság IP54
- polaritás
- CAT III 400 V



So. leírás

18428



1

FESTA

MULTIMÉTER

- DC feszültségmérés: 200 mV - 300 V
- AC feszültségmérés: 200 mV - 300 V
- Egyenáram mérése: 2000 μ A - 10 A
- ellenállásmérés: 200 Ω - 2 M Ω
- akkumulátor ellenőrzés: 1,5V, 9V
- lemerült akkumulátor jelzés
- túltöltés elleni védelem

- IEC61010
- CATIII 300V
- GS tanúsítvány
- Tápellátás: 9 V-os elem (6F22)
- méretek: 70x128x28 mm
- súly: 137 g (akkumulátorral)
- tartozékok: tesztkábelek



So. leírás

18429



1



FESTA

AUTOMATA KÁBEL CSUPASZÍTÓ FOGÓ

- 0,5 - 6 mm²
- 190 mm

R. s. leírás

17178



1



FESTA

DERÉKSZÖG 3D



So. leírás
14418



10

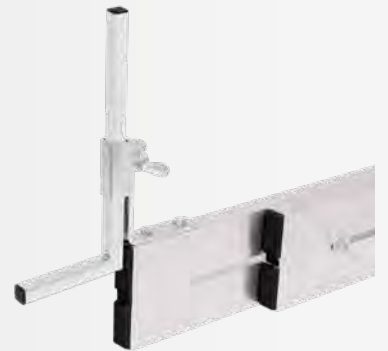

HORIZONT

ÖLESZÉC 1 LIBELLÁS - ÁLLÍTHATÓ

So.	leírás
15893	65 - 100 cm
15894	95 - 150 cm
15895	145 - 235 cm



1
1
1



FESTA

**ALKOHOLOS
FILCTOLL**



So.	leírás	46
13247	● piros	46
13248	○ fehér	46



FESTA

VÍZPUMPAFOGÓ

CrV

So.	leírás	1
16500	180 mm 0 - 35 mm	1
16501	250 mm 0 - 45 mm	1
16502	300 mm 0 - 60 mm	1



1
1
1



FESTA

CSAPSZEGVÁGÓ, KÁBELVÁGÓVAL

450 mm

Cr-Mo

So. leírás

17049



1



26730

26731

FESTA

RÚDHAJLÍTÓ

So.	leírás
26730	Ø 6 - 14 mm
26731	Ø 5 - 8 mm



1

1



RÚDHAJLÍTÓ

So.	leírás
26735	max Ø 13 mm 56 cm



1



PATENTFOGÓ

So.	leírás	
17150	220 mm	1



PATENTFOGÓ

So.	leírás	
17151	220 mm	1

FESTA

LEMEZVÁGÓ OLLÓ HOSSZÚ



Cr-Mo

HRC 58-62



So.	leírás	
17113	egyenes 80 300 mm	6



FESTA

LEMEZVÁGÓ ADAPTER



So.	leírás	
20364		1



FESTA

CSÓ VÁGÓ

INOX ALU

ALU Cu PVC

So.	leírás	
16305	Ø 22 mm	10
16306	Ø 15 mm	10



FESTA
INDUSTRY

TORZIÓS BIT PH - 50 MM



S2

2x

So.	leírás	
18715	PH1 x 50 mm	1
18716	PH2 x 50 mm	1
18717	PH3 x 50 mm	1



FESTA
INDUSTRY

TORZIÓS BIT PZ - 50 MM



S2

2x

So.	leírás	
18710	PZ1 x 50 mm	1
18711	PZ2 x 50 mm	1
18712	PZ3 x 50 mm	1



FESTA
INDUSTRY

TORZIÓS BIT T - 50 MM



S2

2x

So.	leírás	
18720	T10 x 50 mm	1
18721	T15 x 50 mm	1
18722	T20 x 50 mm	1
18723	T25 x 50 mm	1
18724	T30 x 50 mm	1
18725	T40 x 50 mm	1

FESTA

BIT KLT.

bit	25 mm		
⊖	S	3 · 4 · 5 · 6	
⊕	PH	0 · 1 · 2 · 3	
⊛	PZ	0 · 1 · 2 · 3	
⊙	H	3 · 4 · 5 · 6	
⊛	T	10 · 15 · 20 · 25 · 27 · 30 · 40	
⊛	TTα	10 · 15 · 20 · 25 · 27 · 30 · 40	

toldalék bitekre

32x

CrV



So.	leírás	
18908		1



FESTA

SZEGECSEŐ TARTOZÉK FÚRÓHOZ

- Ø 2,4 mm
- Ø 3,2 mm
- Ø 4,0 mm
- Ø 4,8 mm



Cr-Mo

So. leírás
24008



FESTA

LEVEGŐPISZTOLY NYOMÁSMÉRŐVEL

- 0 - 10 bar
- LCD display
- bar, kPa, Psi, kgf/cm²



So. leírás
48011 0 - 10 bar



10

FESTA

LEVEGŐPISZTOLY

- 25 mm
- 90 mm
- 190 mm

So. leírás
48004



10



FESTA

90° SATU



4x

Sz. leírás
23607 szorítóerő - 250 N



1



FESTA

ÁLLÍTHATÓ BAK

· max. terhelés: 400 kg

Sz. leírás
23658



1



NYLON KESZTYŰ LATEX ÁZTATÁS

CE EN
388

R.sz.	leírás	
50535	tméretű 8"	12
50536	tméretű 9"	12

BIZTONSÁGI KÉS

R.sz.	leírás	
16044		20

pengető rendszer



FESTA
INDUSTRY

TÖRHEŐ PENGÉS KÉS

· Csúszásgátló gumi bevonat

R.sz.	leírás	
16099	18 mm	1

FESTA

ÉLEZŐ 16v1



	30° Anvil	
	45° Anvil	
	50° Anvil	
	23° Bypass	
	35° Bypass	
	65° Bypass	
	Debur Tool	



R.sz.	leírás	
45073		1

FÚRÓ KÉSZLET

fafúró	Ø 3 · 4 · 5 · 6 · 8 mm
fémfúró	Ø 1 · 1,5 · 2 · 2,5 · 3 · 3,5 · 4 · 4,5 · 5 · 5,5 · 6 · 7 · 8 · 10 mm
falazófúró	Ø 4 · 5 · 6 · 8 · 10 mm
lapos fafúró	Ø 16 · 22 · 25 mm
lyukfűrész	Ø 32 · 38 · 44 · 54 mm
mélységütők	Ø 6 · 8 · 10 mm
pontozó	
fúrósár átmérő mérő	

bit 25 mm	⊖ S	3 · 4 · 4 · 5 · 5 · 6 · 6 · 7
	⊕ PH	0 · 0 · 1 · 1 · 2 · 2 · 2 · 3 · 3
	✱ PZ	0 · 0 · 1 · 1 · 2 · 2 · 2 · 3 · 3
	● H	2 · 2,5 · 3 · 3,5 · 4 · 5 · 6
	✱ T	10 · 15 · 20 · 25 · 27 · 30 · 40

bit 50 mm	⊖ S	4 · 5 · 6 · 6
	⊕ PH	1 · 2 · 2 · 3
	✱ PZ	1 · 2 · 2 · 3

adapter sorjázó bittartó	○	4 · 5 · 6 · 7 · 8 · 9 · 10 · 13 mm
--------------------------	---	------------------------------------



100x

R.sz. leírás

20340



1

FESTA

JAPÁN FÚRÉSZ

1 2 3 · 3x élezett, edzett fogazás



R.sz.	leírás
24134	250 mm 0,5 mm



10

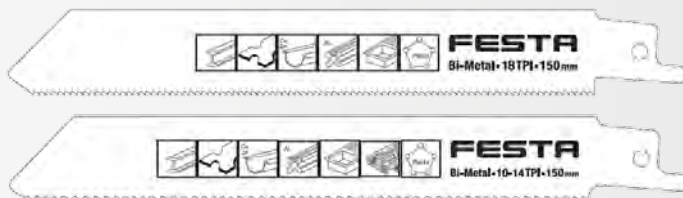

FESTA

NYÉL FÚRÉSZLAPOKHOZ

· nyél + 2x fűrészlap
· dugattyús fűrészlapokhoz

R.sz. leírás

24325



1



GYÉMÁNT KÖRKIVÁGÓ KÉSZLET

- Ø 6 mm
- Ø 8 mm
- Ø 25 mm
- Ø 35 mm
- Ø 40 mm
- Ø 50 mm
- Ø 68 mm

7x **M14**

- Kerámia csempék
- Márvány
- Gránit

- nincs szükség vízűtésre



R.sz. Leírás

24651



1



GYÉMÁNT KÖRKIVÁGÓ KÉSZLET

- Ø 6 mm
- Ø 8 mm
- Ø 10 mm
- Ø 12 mm
- Ø 20 mm
- Ø 28 mm
- Ø 35 mm
- Ø 45 mm
- Ø 55 mm
- Ø 68 mm

vágótárcsa / csiszolótárcsa Ø 125 mm x 2,0 mm Ø 22,2 mm

vágótárcsa Ø 125 mm x 1,2 mm Ø 22,2 mm

gyémánt csiszoló korona Ø 0 - 50 mm

gyémántcsiszoló szivacs 90 x 55 mm P60

13x **M14**

- Kerámia csempék
- Márvány
- Gránit

- nincs szükség vízűtésre



R.sz. Leírás

24652



1



GYÉMÁNT KÖRKIVÁGÓ

M14



- Kerámia csempék
- Márvány
- Gránit



- nincs szükség vízhűtésre



R.sz.	Leírás		
24620	Ø 6 mm	M14	1
24621	Ø 8 mm	M14	1
24622	Ø 10 mm	M14	1
24623	Ø 12 mm	M14	1
24624	Ø 14 mm	M14	1
24627	Ø 20 mm	M14	1
24630	Ø 28 mm	M14	1
24633	Ø 35 mm	M14	1
24636	Ø 45 mm	M14	1
24638	Ø 55 mm	M14	1
24640	Ø 68 mm	M14	1
24643	Ø 75 mm	M14	1



GYÉMÁNT CSISZOLÓ KORONA

M14



- Kerámia csempék
- Márvány
- Gránit



- nincs szükség vízhűtésre



R.sz.	Leírás		
24797	Ø 6 - 50 mm		1
24799	Ø 10 - 50 mm		1



GYÉMÁNT CSISZOLÓ KORONA

M14



- Kerámia csempék
- Márvány
- Gránit



- nincs szükség vízhűtésre



R.sz.	Leírás		
24777	Ø 2 - 75 mm		1



FESTA

GYÉMÁNT KÖRKIVÁGÓ

M14



- Kerámia csempék
- Márvány
- Gránit



- nincs szükség vízűtésre



R.sz.	leírás	űchyt	
24677	Ø102 mm	M14	1
24678	Ø125 mm	M14	1

FESTA

FURÓ ÜVEGHEZ ÉS KERÁMIÁHOZ KLT.

- Ø 4 mm
- Ø 5 mm
- Ø 6 mm
- Ø 8 mm
- Ø 10 mm

5x



- Kerámia csempék
- Márvány
- Gránit



- nincs szükség vízűtésre



R.sz.	Leírás	
24734		1



FESTA

HŰSÍTŐ VIASZ GYÉMÁNT LYUKFŰRÉSZHEZ

R.sz.	Leírás	
24710	30 ml	1

MOQ
9



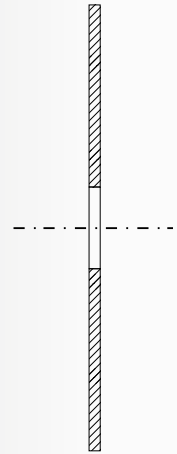
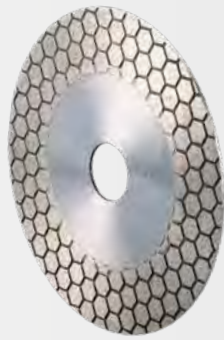

GYÉMÁNT VÁGÓTÁRCSA / CSISZOLÓTÁRCSA



- Kerámia csempék
- Márvány
- Gránit



- nincs szükség vízhűtésre



R.sz.	Leírás		
21230	Ø 115 mm x 1,8 mm	Ø 22,2 mm	1
21231	Ø 125 mm x 2,0 mm	Ø 22,2 mm	1



GYÉMÁNT VÁGÓTÁRCSA TURBO EXTREME



- Kerámia csempék
- Márvány
- Gránit



- nincs szükség vízhűtésre



R.sz.	Leírás		
21205	Ø 125 mm x 2,0 mm	Ø 22,2 mm	1
21209	Ø 230 mm x 2,6 mm	Ø 22,2 mm	1

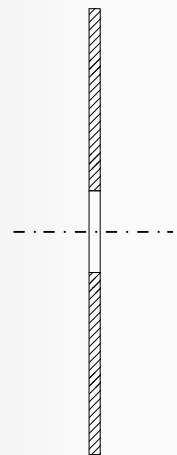

GYÉMÁNT VÁGÓTÁRCSA



- Kerámia csempék
- Márvány
- Gránit



- nincs szükség vízhűtésre



R.sz.	Leírás		
21235	Ø 125 mm x 1,2 x 8 mm	Ø 22,2 mm	1

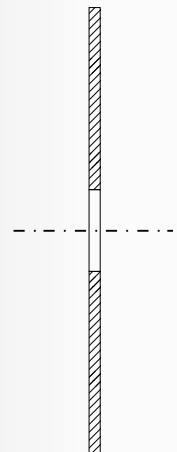

FESTA**LAMELLÁS GYÉMÁNT CSISZOLÓ**

pro zábrus dlažeb



- Kerámia csempék
- Márvány
- Gránit



· nincs szükség vízhűtésre

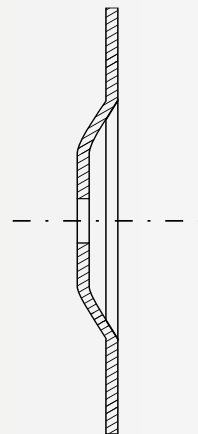

R.sz.	Leírás			
24647	Ø 115 mm	Ø 22,2 mm	P60	1
24648	Ø 115 mm	Ø 22,2 mm	P120	1
24649	Ø 115 mm	Ø 22,2 mm	P200	1

FESTA**GYÉMÁNT CSISZOLÓTÁRCSA**

R.sz.	Leírás			
21435	Ø 115 mm	Ø 22,2 mm		1
21436	Ø 125 mm	Ø 22,2 mm		1
21437	Ø 150 mm	Ø 22,2 mm		1

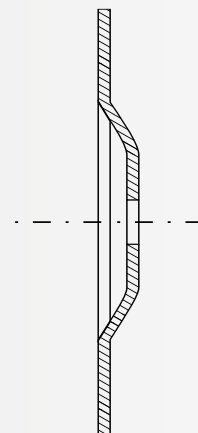
**FESTA****FAFORGÁCSOLÓ KORONG**

R.sz.	Leírás			
21806	Ø 125 mm	Ø 22,2 mm		10

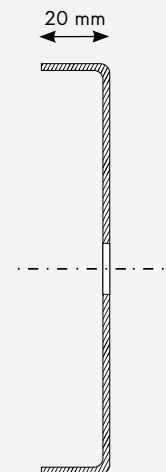

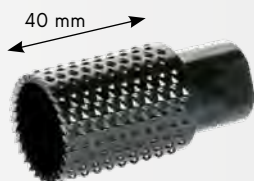

FESTA

PROFILMARÓ

M14



R.s. Leírás
21807 Ø 30 mm / 60 mm

1

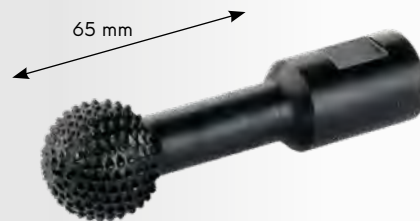

FESTA

PROFILMARÓ

M14



R.s. Leírás
21808 Ø 30 mm / 105 mm

10



FESTA

MENETFÚRÓ HAJTÓSZÁR

DIN
1814



R.s. Leírás
20394 M5 - M20

10



SZERVEZŐ DOBOZ



R.s. Leírás
55650 375 x 290 x 67 mm

1



FESTA

ROZSDAMENTES SPAKLI

INOX



R.s. leírás
31517

10



FESTA

LAPOS VÉSŐ SDS+

SDS+



R.s. leírás
20996 250 x 100 mm

1



SZILIKON FUGAKIHÚZÓ

4x



R.s. leírás
37052

1

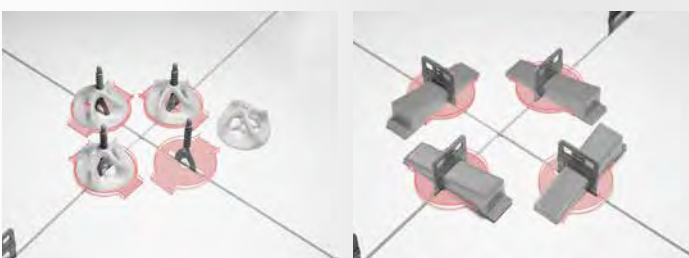

KÉZI DÖNGŐLŐ

R.s. leírás
26740 12 kg

1



FESTA

MŰANYAG FUGAKERESZT

100x



R.s.	leírás	
37285	1,5 mm	100
37286	2 mm	100
37287	2,5 mm	100
37288	3 mm	100
37289	4 mm	100

NIVELYS
LEVELLING SYSTEMS **FESTA**

VÉDŐLAPOK CSEMPESZINTEZŐ RENDSZEREKHEZ

100x



R.s. leírás
37192

1

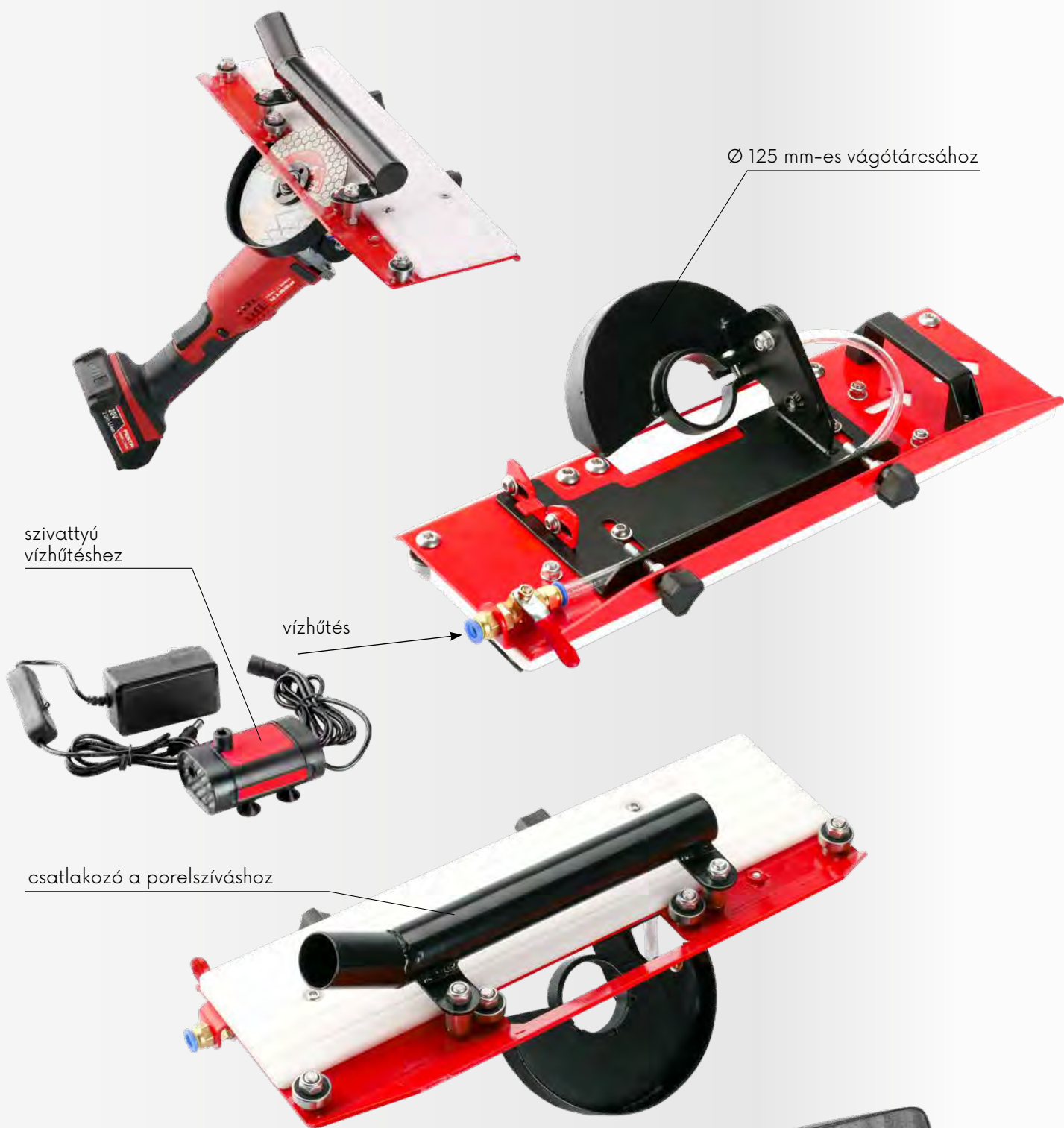

FESTER

**SPECIÁLIS ADAPTER BURKOLÓLAPOK,
45° FOKBAN TÖRTÉNŐ GÉRVÁGÁSÁHOZ**

A készlet tartalma:

- vezetősín
- szivattyú vízűtéshez
- tartalék tömlő vízűtéshez
- szállítótáska





1/4" + 5/8"



60 - 150 cm

KÉZIU LÉGTELENÍTŐ KULCS

2x



R.s. leírás
17454 5 x 5 mm

HÁROMLÁBÚ ÁLLVÁNY

ALU



R.s. leírás
26219 60 - 150 cm 1/4" + 5/8"



FESTA

PORELSZÍVÓ

R.s. leírás
28267 max. 70 mm

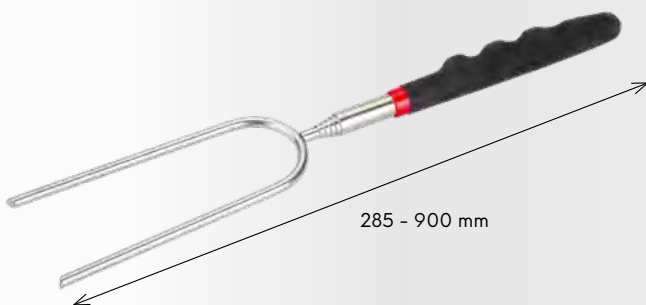

285 - 900 mm



GRILLVILLA - TELESZKÓPOS

INOX



R.s. leírás
43094

KALAPÁCSOK TARTÓ

Zn

FESTA állványhoz kompatibilis



R.s. leírás
81188 max 2 kg

ALKALMAZOTT PIKTOGRAMOK LISTÁJA

· TERMÉKLEÍRÁS

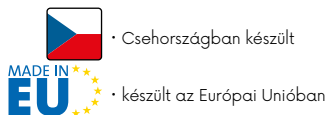

ALKALMAZÁSI ELŐÍRÁSOK ·

- fa ·
- kerámia ·
- muanyag ·
- alumínium · **ALU**
- réz · **Cu**
- kő ·
- üveg ·
- falazat / tégl ·
- papír ·
- acél ·
- összetett ·
- csemp ·
- rozsdamentes acél · **INOX**
- vakolat ·
- fa csavarral, szögek ·
- gipszkarton ·
- anyagok fúrására ... húzószilárdságig · **900 MPa**

- S2** · acél S2
- HSS** · nagysebességű acélvágó
- Cr-Mo** · króm-molibdén acél
- CrV** · króm-vanádium acél
- INOX** · rozsdamentes acél
- NYLON** · nylon fogantyú
- TEFLON** · teflon felület
- Zn** · horganyzott felület
- TiN** · titán-nitrid bevonatú felület
- HRC 58-61** · HRC - anyag keménysége
- 40% PES** · az anyag százalékos összetétele - 40% poliészter
- PES** · 100% poliészter
- gyémánt felületi felület
- a termék vagy annak valamely része mágneses

- SDS+** **SDS MAX** **M14** · szerelési módszer
- 72T** **36T** · a fogak száma a racsos villás kulcsban
- 1/2"** **3/4"** **1/4"** · racsos
- 27 dB** · Információ a hangvédelemről
- DIN 3113** **IP 54** · alapértelmezett
- 32x** · darabszám darabban
- II. class** **III. class** · pontossági osztály
- hideg időre alkalmas
- ERGO HANDLE** · ergonomikus fogantyú
- HOBBY** · hobbi
- 2x AAA** · elemek száma és típusa
- UV STABLE** · UV stabil
- RUBBER ENDS** · ütközésgátló gumi végek



· CSOMAGOLÁSI INFORMÁCIÓK

- dobozba csomagolva
- euroslot
- MOQ 12** · Minimális rendelési mennyiség
- darabszám a csomagban

ALKALMAZOTT PIKTOGRAMOK LISTÁJA - FESTA AQUATIC, ROSA ·

állítható permetezési minták ·

- minimális és maximális nyomás · **2bar min** **4bar max**
- maximális vízáram · **Max 27L/min**
- öntözött terület · **318 m²**
- adapter menete mérete · **1/2"**
- tömlő átmérője · **1/2"**





PROFI X SZERSZÁMOK



festatools



#festatools



festatools

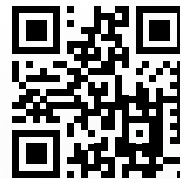

www.festa.tools

HORIZONT.

FESTA
POWER X TOOLS

FESTA
AQUATIC

KDS KOMELON.

ROSA

Stahlberg

Lescha SUPER PRO

