



FESTA

PROFESSIONAL  TOOLS



20
25
—
26

FESTA
POWER X TOOLS

Comprehensive group of battery products using quality components, the latest technologies and current trends in battery tools

FESTA

Brand of high quality hand tools for building, workshop and garden

FESTA
INDUSTRY

A premium range of selected tools and hand tools of the highest quality, designed for demanding working conditions where performance is a priority.

FESTA
AQUATIC

Professional watering assortment with modern design, compatible with Rosa product line

HORIZONT
MASTER

Brand of top quality levels

HORIZONT

Brand of high quality levels and mason staff

ROSA

Quality watering systems and garden tools

KDS[®]

Japanese knives with a long tradition

KOMELON[®]

Professional measuring tapes



Professional tile cutter



Manufacturer of quality garden shears

Lescha

Professional building mixers

Stahlberg

Professional screwdriver attachments



Brand of professional saws

POWER TOOLS

2 - 53



CUTTING AND GRINDING TOOLS

54 - 93



WORKSHOP TOOLS

94 - 205



WORKSHOP

206 - 241

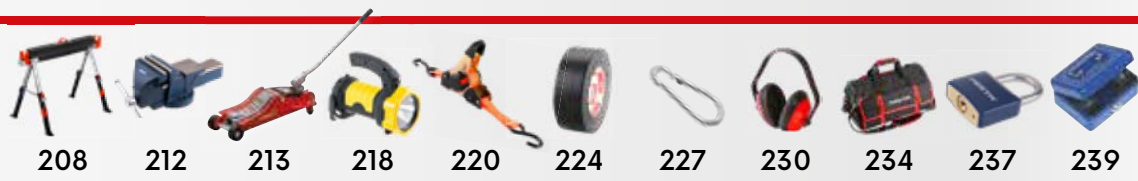

BUILDING TOOLS

242 - 307

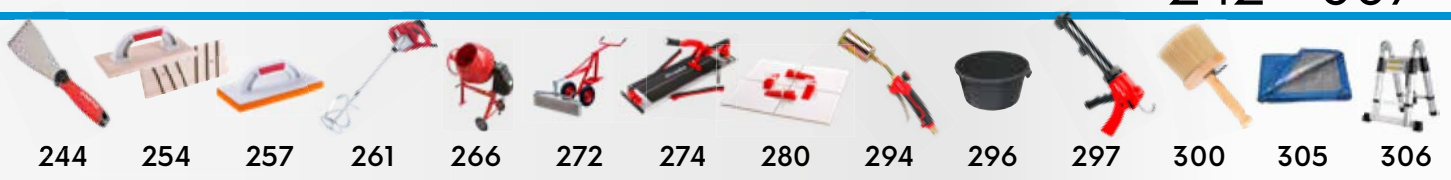

GARDEN TOOLS

308 - 359

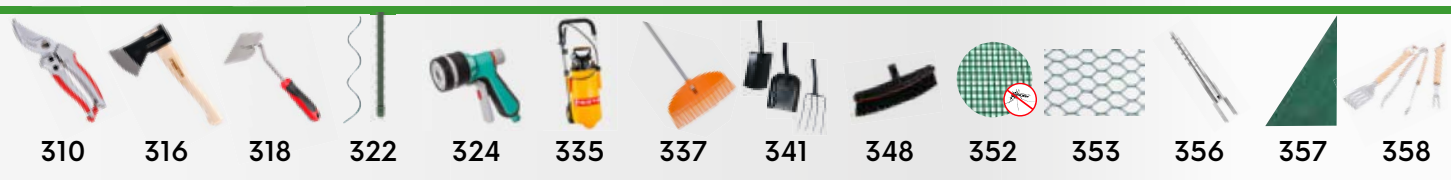

FESTA

360 - 365



LIST OF ITEMS

366 - 380



DRILL

4



HAMMER DRILL

9



NAILER AND STAPLER

10



ANGLE GRINDER

11



ORBITAL SANDER

12



CIRCULAR SAW

13



AIR COMPRESSOR

15



TILE VIBRATION
LEVELING MACHINE

16



CAULKING GUN

17



LED LIGHT

17



RADIO DAB+ / FM / BT

18



HAMMER DRILL

23



CIRCULAR SAW

26



ANGLE GRINDER

27



DRYWALL SANDER

36



VACUUM CLEANERS

37



ELECTRIC MIXER

38



HIGH PRESSURE CLEANERS

39

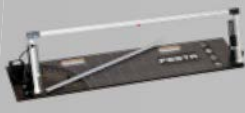

POLYSTYRENE CUTTERS

40



WELDING INVERTER

43



POLYFUSION WELDERS

45



COMPRESSORS
AND ACCESSORIES

46



HOT AIR GUNS

50



HEATERS

52



EXTENSION CABLES

53



ELECTRIC
POWER TOOLS

2 - 53



FESTA
POWER X TOOLS

BRUSHLESS **SHARE** **20V** *Li-ion technology*

speed
0-550 min⁻¹
0-2000 min⁻¹

mass
with battery 2,0 Ah **1,8 kg**
with battery 4,0 Ah **2,1 kg**

torque
80 Nm

chuck
2 - 13 mm



- The set contains:
- hammer drill
 - 2.0 Ah battery
 - 4.0 Ah battery
 - 2.4 A charger
 - additional handle
 - suitcase



FESTA
POWER X TOOLS

HAMMER DRILL CORDLESS

max 80 Nm		I.O-8800 bpm II.O-32000 bpm	I.O-550min ⁻¹ II.O-2000min ⁻¹		2-13 mm		LED	KG 1,4	2x	Li-ion
--------------	--	--------------------------------	--	--	---------	--	-----	-----------	----	--------

No. specifications
28000

2

BRUSHLESS SHARE 20V Li-ion technology

speed
0-550 min⁻¹
0-2000 min⁻¹

mass
with battery 2,0 Ah **1,8 kg**
with battery 4,0 Ah **2,1 kg**

torque
80 Nm

chuck
2 - 13 mm

- The set contains:
- hammer drill
 - 2.0 Ah battery
 - 2.4 A charger
 - additional handle
 - suitcase



mode selection
choice of torque force

additional handle

speed switch

quick release
chuck head

direction of
rotation switch

ergonomic rubberized
handle for a comfortable
and secure grip

LED lighting

hook for hanging

battery lock



HAMMER DRILL CORDLESS

max 80 Nm		I.0-8800 bpm II.0-32000 bpm	I.0-550min ⁻¹ II.0-2000min ⁻¹				LED		1,8 / 1,4	1x	Li-ion
--------------	--	--------------------------------	--	--	--	--	-----	--	-----------	----	--------



No. specifications
28001

2

BRUSHLESS SHARE 20V

speed
0-550 min⁻¹
0-2000 min⁻¹

mass
without battery
1,4 kg

torque
80 Nm

chuck
2 - 13 mm

Recommended

- SHARE 20V Li-ion technology**
- battery*
2 Ah - 28080
4 Ah - 28081
8 Ah - 28083
- charger*
2,4 A - 28085
4,0 A - 28086

mode selection
choice of torque force

additional handle

speed switch

quick release
chuck head

direction
of rotation switch

ergonomic rubberized
handle for a comfortable
and secure grip

LED lighting

hook for hanging



HAMMER DRILL CORDLESS

max 80 Nm		I.0-8800 bpm II.0-32000 bpm	I.0-550min ⁻¹ II.0-2000min ⁻¹				LED		1,4
--------------	--	--------------------------------	--	--	--	--	-----	--	-----

*battery and charger are not included

No. specifications
28002

5

SHARE
20V

Li-ion
technology

speed
0-500 min⁻¹
0-1800 min⁻¹

mass
with battery **2,0 Ah**
1,7 kg

torque
45 Nm

chuck
2 - 13 mm

The set contains:

- hammer drill
- 2x 2.0 Ah Battery
- 2.4 A charger
- suitcase
- carrier and bits:

- ⊖ S5, S6 x 25 mm
- ⊕ PH1, PH2 x 25 mm
- ⊕ PZ1, PZ2 x 25 mm
- HSS drills
2-2.5-3-4-5-6 mm



mode selection
choice of torque force

quick release
chuck head

speed switch

direction of rotation

ergonomic rubberized
handle for a comfortable
and secure grip

LED lighting

hook for hanging

battery lock



FESTA
POWER X TOOLS

HAMMER DRILL CORDLESS

max 45 Nm		0-19200 bpm	0-500min ⁻¹ 0-1800min ⁻¹		2-13 mm		LED		2x	Li-ion
--------------	--	----------------	---	--	------------	--	------------	--	----	--------



No. specifications 28003 3

SHARE
20V

speed
0-550 min⁻¹
0-2000 min⁻¹

mass
without battery
1,4 kg

torque
45 Nm

chuck
2 - 13 mm

Recommended

- SHARE**
20V
Li-ion
technology
- battery* 2 Ah - 28080
4 Ah - 28081
8 Ah - 28083
- charger* 2,4 A - 28085
4,0 A - 28086



mode selection
choice of torque force

quick release
chuck head

speed switch

direction of rotation

ergonomic rubberized
handle for a comfortable
and secure grip

LED lighting

hook for hanging



FESTA
POWER X TOOLS

HAMMER DRILL CORDLESS

max 45 Nm		0-19200 bpm	0-500min ⁻¹ 0-1800min ⁻¹		2-13 mm		LED		1,4
--------------	--	----------------	---	--	------------	--	------------	--	-----

*battery and charger are not included

No. specifications 28004 5

SHARE
20V *Li-ion*
technology

speed
0-350 min⁻¹
0-1300 min⁻¹

mass
with battery 2,0 Ah
1,3 kg

torque
28 Nm

chuck
1 - 10 mm

- The set contains:
- hammer drill
 - 2x 2.0 Ah Battery
 - 2.4 A charger
 - suitcase
 - carrier and bits:
 - ⊖ S5, S6 x 25 mm
 - ⊕ PH1, PH2 x 25 mm
 - ⊕ PZ1, PZ2 x 25 mm
 - drills HSS
 - 1,5-2,5-3-4-5-6 mm



mode selection
choice of torque force

quick release
chuck head

speed switch

direction of
rotation switch

ergonomic rubberized
handle for a comfortable
and secure grip

LED lighting

hook for hanging

battery lock



DRILL CORDLESS SCREWDRIVER

max 28 Nm		L0-350min ⁻¹ H0-1300min ⁻¹				LED	1,3 / 0,9	2x	Li-ion
--------------	--	---	--	--	--	-----	-----------	----	--------



No. specifications
28005

3

SHARE
20V

speed
0-350 min⁻¹
0-1300 min⁻¹

mass
without battery
0,9 kg

torque
28 Nm

chuck
1 - 10 mm

Recommended

- SHARE**
20V *Li-ion*
technology
- battery* 2 Ah - 28080
- 4 Ah - 28081
- 8 Ah - 28083
- charger* 2,4 A - 28085
- 4,0 A - 28086

mode selection
choice of torque force

quick release
chuck head

speed switch

direction of
rotation switch

ergonomic rubberized
handle for a comfortable
and secure grip

LED lighting

hook for hanging



DRILL CORDLESS SCREWDRIVER

max 28 Nm		L0-350min ⁻¹ H0-1300min ⁻¹				LED	0,9
--------------	--	---	--	--	--	-----	-----

*battery and charger are not included

No. specifications
28006



5

Li-ion
technology

speed
0-350 min⁻¹
0-1300 min⁻¹

mass
with battery 1,5 Ah
1 kg

torque
20 Nm

chuck
1 - 10 mm

- The set contains:
- hammer drill
 - 2x battery 12 V | 1.5 Ah
 - charger 12 V | 2.4 A
 - suitcase
 - carrier and bits:
 - ⊖ S5, S6 x 25 mm
 - ⊕ PH1, PH2 x 25 mm
 - ⊕ PZ1, PZ2 x 25 mm
 - drills HSS
1,5-2,5-3-4-5-6 mm



mode selection
choice of torque force

quick release
chuck head

speed switch

LED lighting

battery charge indicator

direction of
rotation

ergonomic rubberized
handle for a comfortable
and secure grip

battery

FESTA
POWER X TOOLS

DRILL CORDLESS SCREWDRIVER

max 20 Nm		1.0-350min ⁻¹ 0.0-1300min ⁻¹		1-10 mm		LED	1	2x	Li-ion
--------------	--	---	--	---------	--	-----	---	----	--------



No. specifications
28007

5

Li-ion
technology

speed
without load
200 min⁻¹

mass
with battery 1,5 Ah
0,4 kg

maximum torque
3 Nm

tool carrier
1/4" hexagon

- The set contains:
- screwdriver
 - charger 5 V | 0,5 A
 - carrier and bits:
 - ⊖ S5 x 50 mm
 - ⊕ PH1 x 50 mm
 - ⊕ PH2 x 50 mm
 - ⊕ H5 x 50 mm
 - ⊕ T20 x 50 mm

1/4 "quick-release
head with fuse

settings torque

battery charge indicator

setting lock
handle position

LED lighting

direction of
rotation switch

ergonomic rubberized
handle for a comfortable
and secure grip



FESTA
POWER X TOOLS

CORDLESS SCREWDRIVER

max 3 Nm	200min ⁻¹	1/4"		LED	0,4	Li-ion	3,6 V 1,5 Ah
-------------	----------------------	------	--	-----	-----	--------	-----------------

No. specifications
28008



LED lighting



10

SHARE
20V

speed without load
0-2000 min⁻¹

mass without battery
1,2 kg

torque
150 Nm

number of strokes
0-3000 bpm

1/4 "quick-release head with fuse

selectable direction of rotation

ergonomic rubberized handle for a comfortable and secure grip



LED lighting

hook for hanging



SHARE
20V
Li-ion technology

Recommended

battery*	2 Ah - 28080	
	4 Ah - 28081	
	8 Ah - 28083	
charger*	2,4 A - 28085	
	4,0 A - 28086	



CORDLESS IMPACT WRENCH

max 150 Nm	0-2000min ⁻¹	0-3000bpm	1/4"			LED	KG 1,2
----------------------	-------------------------	-----------	------	--	--	-----	-----------

*battery and charger are not included

No. specifications
28021



5

SHARE
20V

speed without load
I.0-300 min⁻¹
II.0-1000 min⁻¹

mass without battery
1,7 kg

BPM / impact
0-5000 / 1,2 J

handle
SDS+

depth stop

SDS clamping tool head

work mode switching (with / without percussion)



speed switch

direction of rotation switch



SHARE
20V
Li-ion technology

Recommended

battery*	2 Ah - 28080	
	4 Ah - 28081	
	8 Ah - 28083	
charger*	2,4 A - 28085	
	4,0 A - 28086	



CORDLESS HAMMER DRILL

	1.0-300 min ⁻¹ II.0-1000 min ⁻¹	0-5000 bpm	1,2J		SDS+		KG 1,7
---	--	------------	------	---	------	---	-----------

*battery and charger are not included

No. specifications
28025



concrete - ø 20 mm
MAX ø metals - ø 10 mm
wood - ø 20 mm



2

SHARE
20V

frequency shooting
60-100 min⁻¹

maximum length nails / staples
30 mm hard materials

maximum length nails / staples
50 mm soft materials

mass without battery
2,7 kg



SHARE
20V
Li-ion technology

Recommended

- battery* 2 Ah - 28080
- 4 Ah - 28081
- 8 Ah - 28083
- charger* 2,4 A - 28085
- 4,0 A - 28086



Nails

- 23930** Nailing nail 30 mm, 2000 pcs
- 23931** Nailing nail 40 mm, 2000 pcs
- 23932** Nailing nail 50 mm, 2000 pcs

Buckle

- 23935** Nail clip 30 mm, 2000 pcs
- 23936** Nail clip 40 mm, 2000 pcs

Suitable types of nails and staples:

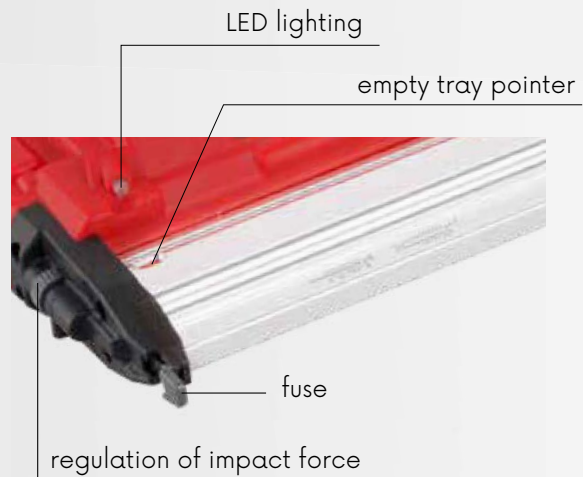
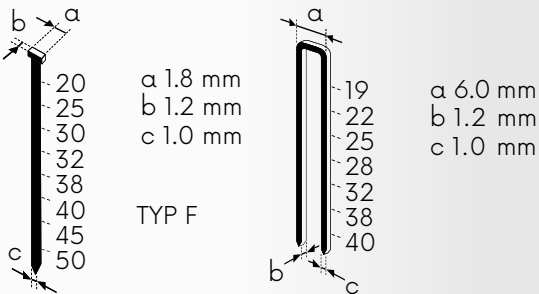

CORDLESS NAILER AND STAPLER

max 60 min⁻¹ | TYPE F | LED | 2,7 kg

*battery and charger are not included

No.	specifications
28070	



BRUSHLESS SHARE 20V

speed without load
8500 min⁻¹

mass without battery
1,6 kg

maximum thickness cut material
15 mm

maximal wheel diameter
125 mm

Recommended

SHARE 20V battery*
Li-ion technology

charger*

2 Ah - 28080
4 Ah - 28081
8 Ah - 28083
2,4 A - 28085
4,0 A - 28086



CORDLESS ANGLE GRINDER

8500 min ⁻¹	max ∅ 125mm	M14	L R	KG 1,6
------------------------	-------------------	-----	-----	-----------

*battery, charger and disc are not included

No. specifications
28030

engine vents

ergonomic rubberized handle for a comfortable and secure grip

rotation lock

fuse operating switch

quick release mechanism
protective cover

wheel clamping nuts



4

SHARE 20V

speed without load
8000 min⁻¹

mass without battery
1,6 kg

maximum thickness cut material
15 mm

maximal wheel diameter
115 mm

Recommended

SHARE 20V battery*
Li-ion technology

charger*

2 Ah - 28080
4 Ah - 28081
8 Ah - 28083
2,4 A - 28085
4,0 A - 28086



CORDLESS ANGLE GRINDER

8000 min ⁻¹	max ∅ 115mm	M14	L R	KG 1,6
------------------------	-------------------	-----	-----	-----------

*battery, charger and disc are not included

No. specifications
28032

ergonomic rubberized handle for a comfortable and secure grip

rotation lock

fuse operating switch

quick release mechanism
protective cover

wheel clamping nuts



4

SHARE
20V

speed without load
10000 min⁻¹

mass without battery
1 kg

eccentricity wheels
5 mm

diameter wheels
125 mm



SHARE
20V
Li-ion technology

Recommended

battery* 2 Ah - 28080
4 Ah - 28081
8 Ah - 28083

charger* 2,4 A - 28085
4,0 A - 28086



BATTERY ORBITAL SANDER



*battery and charger are not included

No. specifications
28040



SHARE
20V

number of oscillations without load
5000-15000 min⁻¹

mass without battery
1 kg

speed control



SHARE
20V
Li-ion technology

Recommended

battery* 2 Ah - 28080
4 Ah - 28081
8 Ah - 28083

charger* 2,4 A - 28085
4,0 A - 28086



CORDLESS DEVICE MULTI-FUNCTIONAL



*battery and charger are not included

No. specifications
28045



SHARE
20V



speed without load **3650 min⁻¹**



adjustable angle of inclination of the cut **45-90 degrees**

max. diameter wheels **165 mm** (ø16 mm)

maximum cut **50 mm**
* at an angle of 90 degrees with disc ø165 mm



Recommended

SHARE 20V Li-ion technology	battery*	2 Ah - 28080	
		4 Ah - 28081	
	charger*	8 Ah - 28083	
		2,4 A - 28085	
		4,0 A - 28086	



CORDLESS CIRCULAR SAW

- The set contains:
- circular saw
 - side guide
 - wrench
 - saw blade ø 165 x 2,8/2,0 x 20 mm 24T (**22314**)



			
3650min ⁻¹	ø 165x16mm	L R	2,7 kg

No. specifications

28035



SHARE
20V

number of blade strokes

0-2400 min⁻¹

mass without battery
1,8 kg

max. angle bevel cut
45 degrees

max. cut profile
steel: 6 mm
wood: 80 mm

Recommended

2 Ah - 28080

battery* 4 Ah - 28081

8 Ah - 28083

charger* 2,4 A - 28085

4,0 A - 28086



SHARE
20V
Li-ion
technology

FESTA
POWER X TOOLS

CORDLESS JIGSAW



*battery and charger are not included

No. specifications
28050

ergonomic rubberized handle for a comfortable and secure grip

fuse operating switch

pre-oscillation setting

LED

bar locking

guide rail

paw slope locking

base

bevel the cut

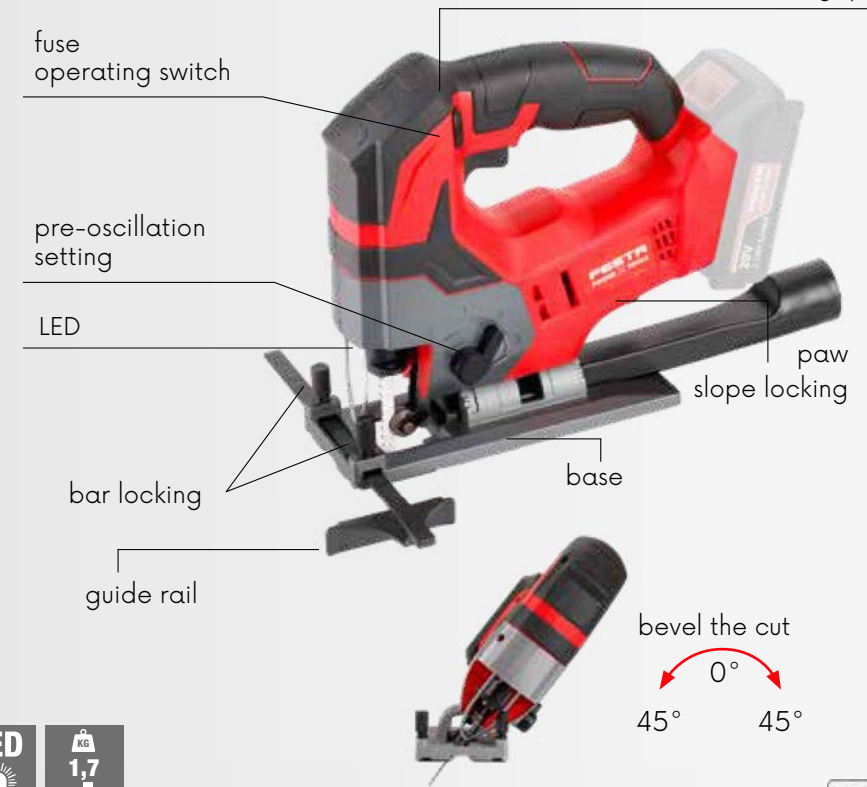

SHARE
20V

number of oscillations without load

0-3000 min⁻¹

mass without battery
1,7 kg

max. cutting thickness

Wood: 100 mm

Steel: 5 mm

aluminum/
copper: 20 mm

Recommended

2 Ah - 28080

battery* 4 Ah - 28081

8 Ah - 28083

charger* 2,4 A - 28085

4,0 A - 28086



SHARE
20V
Li-ion
technology

FESTA
POWER X TOOLS

CORDLESS RECIPROCATING SAW



*battery and charger are not included

No. specifications
28055

fuse operating switch

ergonomic rubberized handle for a comfortable and secure grip

quick release saw blade



SHARE
20V

max. pressure
8,2 bar

manometer
psi, bar,
kgf/cm², kPa

hose
600 mm

voltage
20 V

backlit manometer display



ergonomic rubberized handle for a comfortable and secure grip

quick release chuck for inflating tires

car battery adapter
3 m



adapters

hose
Ø 10,5 x 600 mm

- The set contains:
- compressor
 - power adapter from the car battery
 - 3x inflating adapters



LED light



Recommended

SHARE
20V
Li-ion
technology

- battery*
- 2 Ah - 28080
 - 4 Ah - 28081
 - 8 Ah - 28083
- charger*
- 2,4 A - 28085
 - 4,0 A - 28086



FESTA
POWER X TOOLS

AIR COMPRESSOR

*battery and charger are not included

No.	specifications
28075	
48013 NEW	adapters



1
1



NEW
 horizontal position
 110 kg
 vertical position
 80 kg
 Ø 220 mm
 USB-C



USB - C
 Li-ion technology

FESTA
 POWER X TOOLS

SUCTION CUP

Ø 220 mm	80 kg	110 kg	ROUGH SURFACE	USB-C	Li-ion 3.6V 2Ah
----------	-------	--------	---------------	-------	--------------------

No.	Specifications	
36326		1

SHARE 20V

suction capacity
 60 kg
 weight
 3 kg
 voltage
 20 V
 vibration
 12 levels of adjustment,
 3500 - 8500 r/min

ergonomic rubberized handle for a comfortable and secure grip



illuminated display



suction cup locking lever



suction cup Ø 125 mm



Recommended

SHARE 20V Li-ion technology	battery*	2 Ah - 28080	
		4 Ah - 28081	
		8 Ah - 28083	
charger*		2,4 A - 28085	
		4,0 A - 28086	

The set contains:
 - tile vibrator
 - battery 2,0 Ah (only 36328)
 - charger (only 36328)
 - case



FESTA
 POWER X TOOLS

TILE VIBRATION LEVELING MACHINE

No.	specifications	
36328	with 2Ah battery and charger	1
36329	without battery and charger	1

SHARE
20V

adjustable speed
0-8,7 mm/s

weight
1,7 kg

torque
6500 N

voltage
20 V



Recommended

SHARE
20V
Li-ion technology

battery*
2 Ah - 28080
4 Ah - 28081
8 Ah - 28083

charger*
2,4 A - 28085
4,0 A - 28086



CAULKING GUN AKU

*battery and charger are not included

No.	specifications
28060	



1



ALUMINIUM CARTRIDGE

pro 28060

No.	Specifications
28061	600 ml



1

SHARE
20V

color temperature
5000 K

mass without battery
0,9 kg

luminous flux
2000 lm (100%)

LED power
20W



Recommended

SHARE
20V
Li-ion technology

battery*
2 Ah - 28080
4 Ah - 28081
8 Ah - 28083

charger*
2,4 A - 28085
4,0 A - 28086



setting the light intensity
50%, 100%



360° swivel head adjustment



LED LIGHT AKU

20W	2000 lumen	IP20	0.9 kg
-----	------------	------	--------

*battery and charger are not included

No.	specifications
28065	



2

**SHARE
20V**

- tuner
DAB+ / FM / BT
- power
2x 15 W
- water resistance
IP54
- voltage
20 V



USB for charging 5V



power supply
**SHARE
20V**

FM antenna



color display

Recommended

- SHARE
20V**
*Li-ion
technology*
- battery*
 - 2 Ah - 28080
 - 4 Ah - 28081
 - 8 Ah - 28083
 - charger*
 - 2,4 A - 28085
 - 4,0 A - 28086



AUX IN jack 3,5 mm



stereo speakers

power supply - 230V adapter



RADIO DAB+ / FM / BT

- stereo
- DAB+ / FM
- external input Bluetooth V5.0 / AUX IN 3.5 mm jack
- resistance to water penetration IP54
- 30 preset memory (30 for DAB / 30 for FM)
- USB for charging
- 2.4" color display
- power 2x 15 W
- 20 V / 1.3 A
- power adapter

*battery and charger are not included



SHARE
20V



FESTA
POWER X TOOLS

CHARGER 20 V | 2,4 A

No.	specifications
28085	220 – 240 V, 50 – 60 Hz, 70 W



SHARE
20V



FESTA
POWER X TOOLS

CHARGER 20 V | 4,0 A

No.	specifications
28086	*220 – 240 V, 50 – 60 Hz, 105 W



SHARE *Li-ion technology*
20V



FESTA
POWER X TOOLS

battery charge indicator

BATTERY 20 V | 2,0 Ah

20V	2,0 Ah	Li-ion	KG 0,4
-----	--------	--------	--------



No.	specifications
28080	



SHARE *Li-ion technology*
20V



FESTA
POWER X TOOLS

battery charge indicator

BATTERY 20 V | 4,0 Ah

20V	4,0 Ah	Li-ion	KG 0,7
-----	--------	--------	--------



No.	specifications
28081	



SHARE *Li-ion technology*
20V



NEW

FESTA
POWER X TOOLS

battery charge indicator

BATTERY 20 V | 8,0 Ah

20V	8,0 Ah	Li-ion	KG 1,0
-----	--------	--------	--------



No.	specifications
28083	



SHARE 20V *Li-ion technology*

28080



28085



DISCOUNTED PRICE

FESTA
POWER X TOOLS

CORDLESS SET WITH BAG SET 2+3

28080 - Battery for cordless tools FESTA SHARE20V 2,0 Ah
28085 - Charger FESTA SHARE20V 2,4 A

No.	specifications	
28090		1

SHARE 20V *Li-ion technology*

28004



28025



37330



28030



BRUSHLESS

DISCOUNTED PRICE + FREE BAG

FESTA
POWER X TOOLS

CORDLESS SET WITH BAG SET 3+3

28004 - Drill Cordless with a hammer FESTA SHARE20V
28025 - Drilling hammer Cordless FESTA SDS+ SHARE20V
28030 - Angle grinder Cordless FESTA "BRUSHLESS" SHARE20V 125 mm
28080 - Battery for cordless tools FESTA SHARE20V 2,0 Ah
28081 - Battery for cordless tools FESTA SHARE20V 4,0 Ah
28086 - Charger FESTA SHARE20V 4,0 A

28080



28081



28086



No.	specifications	
28102		1

BRUSHLESS SHARE 20V *Li-ion technology*

28002



37330



28030



DISCOUNTED PRICE + FREE BAG

FESTA
POWER X TOOLS

CORDLESS SET WITH BAG SET 2+3

28002 - Drill Cordless with a hammer FESTA SHARE20V
28030 - Angle grinder Cordless FESTA "BRUSHLESS" SHARE20V 125 mm
28080 - Battery for cordless tools FESTA SHARE20V 2,0 Ah
28081 - Battery for cordless tools FESTA SHARE20V 4,0 Ah
28086 - Charger FESTA SHARE20V 4,0 A

28080



28081



28086



No.	specifications	
28103		1

SHARE
20V *Li-ion*
technology

28004

28032

28055

28035

37330

28040

DISCOUNTED
PRICE
+FREE BAG

FESTA
POWER X TOOLS

CORDLESS SET WITH BAG SET 5+3

- 28004 - Drill Cordless with a hammer FESTA SHARE20V
- 28032 - Angle grinder Cordless FESTA SHARE20V 115 mm
- 28035 - Circular saw Cordless FESTA SHARE20V 165 mm/d 16 mm
- 28040 - Eccentric grinder Cordless FESTA SHARE20V 125 mm 8 otv.
- 28055 - Hack saw Cordless FESTA SHARE20V
- 28080 - Battery for cordless tools FESTA SHARE20V 2,0 Ah
- 28081 - Battery for cordless tools FESTA SHARE20V 4,0 Ah
- 28086 - Charger FESTA SHARE20V 4,0 A



28080



28081



28086



No. specifications

28101



1

SHARE
20V *Li-ion*
technology

BRUSHLESS

28002

28030

28040

BRUSHLESS

37330

28055

28035

DISCOUNTED
PRICE
+FREE BAG

FESTA
POWER X TOOLS

CORDLESS SET WITH BAG SET 5+3

- 28002 - Drill Cordless with a hammer FESTA SHARE20V
- 28030 - Angle grinder Cordless FESTA "BRUSHLESS" SHARE20V 125 mm
- 28035 - Circular saw Cordless FESTA SHARE20V 165 mm/d 16 mm
- 28040 - Eccentric grinder Cordless FESTA SHARE20V 125 mm
- 28055 - Hack saw Cordless FESTA SHARE20V
- 28080 - Battery for cordless tools FESTA SHARE20V 2,0 Ah
- 28081 - Battery for cordless tools FESTA SHARE20V 4,0 Ah
- 28086 - Charger FESTA SHARE20V 4,0 A

28080



28081



28086



No. specifications

28104



1

BRUSHLESS

the tool is powered
brushless DC motor

torque	
speed	
selectable direction of rotation	
chuck	
drilling, hammer drilling, screwing	
number of strokes per minute	
drilling, screwdriving	
mass with / without battery	
method of attachment	
method of attachment	
method of attachment	
disk eccentricity	
control of the device for right and left hand	
meets that standard	
luminous flux	
directional angle of light	
maximum firing frequency	

**SHARE
20V**

the tool is compatible
with both Battery

	suitable types of nails
	suitable types of buckles
	grinding wheel with holes
	maximum wheel diameter
	wheel diameter
	maximum cutting thickness material: wood
	maximum cutting thickness material: steel
	pre-oscillation setting
	saw attachment
	number of blade strokes
	possibility of beveled cut
	quick release of the saw blade
	number of saw oscillations
	LED lighting
	battery capacity
	battery
	charging time battery

NEW

speed
520 min⁻¹

BPM / impact
0 - 4100 / 12 J

power
1500 W

clamping
head
SDS MAX



MAX ∅ concrete - ∅ 40 mm



depth gauge

vibration reduction
system

ergonomic
rubberized
handle for
a comfortable
and secure grip



dust collector

SDS MAX
chuck



side handle

3.0m

FESTA
POWER X TOOLS

**HAMMER DRILL
SDS MAX**

The set contains:

- hammer drill
- side handle
- depth gauge
- wrench
- plastic case
- spare carbon brushes
- dust collector
- accessories SDS MAX:

∅ 16 x 280 mm
| 18 x 320 mm

spare carbons
2 pcs

- 28229

230V ~ 50Hz	1500W	4100 bpm	520min ⁻¹	12J	SDS MAX	3m RUBBER	6.8 kg	MAX ∅40mm Concrete
----------------	-------	-------------	----------------------	-----	------------	--------------	-----------	-----------------------

No.
28221

Specifications



FESTA
POWER X TOOLS





MAX Ø
 concrete - Ø 32 mm
 metals - Ø 13 mm
 wood - Ø 40 mm

speed
 0-850 min⁻¹
 BPM / impact
 0-4500 / 6 J
 power
 1500 W
 clamping head
 SDS+

depth gauge

vibration reduction system

SDS+ chuck

ergonomic rubberized handle for a comfortable and secure grip

side handle



2.0m

FESTA
 POWER X TOOLS

HAMMER DRILL

The set contains:

- hammer drill
- side handle
- depth gauge
- wrench
- plastic case
- spare carbon brushes
- accessories SDS+:

- ⚡ Ø 8, 10, 12 x 160 mm
- 🔩 20 x 250 mm
- 🔩 14 x 250 mm



spare carbon brushes 2 pcs - 28228



230V ~ 50Hz	1500W	0-4500 bpm	0-850 min ⁻¹	6J	SDS+	2m RUBBER	5.0 KG
----------------	-------	------------	-------------------------	----	------	-----------	--------

No. specifications
 28225



speed
0-1350 min⁻¹

BPM / impact
0-5500 / 2,8 J

power
800 W

clamping head
SDS+
ø 2 - 13 mm



MAX ø concrete - ø 25 mm
metals - ø 13 mm
wood - ø 30 mm



FESTA
POWER X TOOLS

HAMMER DRILL

The set contains:

- hammer drill
- side handle
- depth gauge
- chuck ø 2 - 13 mm
- plastic case
- vaseline
- spare carbon brushes
- accessories SDS+:

- ⚔ ø 6, 8, 10 x 160 mm
- ⚔ 20 x 250 mm
- ⚔ 14 x 250 mm



spare carbon brushes 2 pcs - 28223

230V ~ 50Hz	800W	0-5500 bpm	0-1350 min ⁻¹	2.8J	SDS+	2m RUBBER	3.2 KG
----------------	------	------------	--------------------------	------	------	-----------	--------

No. specifications
28220



speed
0-4500 min⁻¹

weight
4,3 kg

power
1400 W

max.
saw blade
diameter / clamping
max ø 185 mm / ø 20 mm



ergonomic
rubberized
handle for
a comfortable
and secure grip



longitudinal cut stop
(side guide)
6 - 120 mm

dust
extraction ø 35 mm

 2.0m

FESTA
POWER X TOOLS

CIRCULAR SAW

The set contains:

- circular saw
- side guide
- wrench
- spare carbon brushes
- saw blade ø 185 x 2,3/1,3 x 20 mm 24T (22316)



22316

1400W	230V ~ 50Hz	4500 min⁻¹	 ø 20 MAX 185mm	 90° 63mm	 45° 42mm	 KG 4.3
--------------	-----------------------	------------------------------	--	--	--	--

spare carbon
brushes 2 pcs - 28233



No. specifications
28230

speed
6600 min⁻¹

weight
5,8 kg

power
2400 W

spindle
thread size
M14
max ø 230 mm



ergonomic rubberized handle for a comfortable and secure grip

SOFT START

smooth engine start

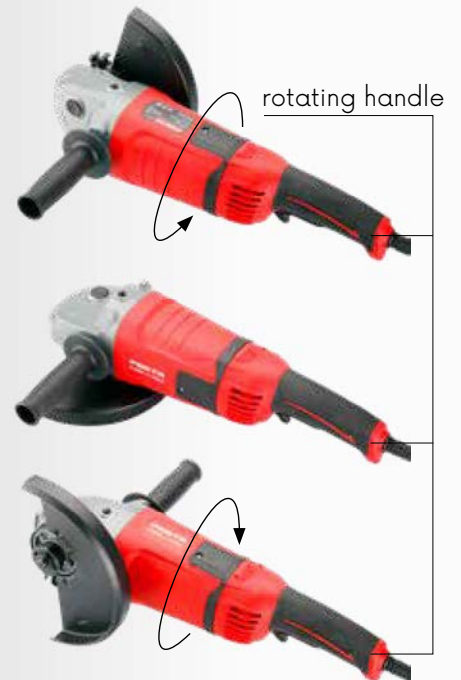

FESTA
POWER X TOOLS

ANGLE GRINDER

- The set contains:
- angle grinder
 - protective guard
 - side handle
 - wrench
 - spare carbon brushes

2400W	230V ~ 50Hz	6600 min ⁻¹ SOFT START	M14	max ø 230mm	2.0m RUBBER	5.8 KG	
-------	----------------	--------------------------------------	-----	-------------	----------------	-----------	--

spare carbon brushes 2 pcs - 28218

speed
11000 min⁻¹

weight
2 kg

power
900 W

spindle
thread size
M14
max ø 125 mm



side handle

SOFT START
smooth engine start



safety switch

3,0m

protective guard



FESTA
POWER X TOOLS

ANGLE GRINDER

The set contains:

- angle grinder
- protective guard
- side handle
- wrench
- spare carbon brushes

900W	230V ~ 50Hz	11000min⁻¹	M14	max ø 125mm	2.0m RUBBER	KG 2.0				
-------------	-----------------------	------------------------------	------------	--------------------	--------------------	---------------	--	--	--	--

spare carbon brushes 2 pcs - 28213



No. specifications
28210

FESTA
POWER X TOOLS

SPARE CARBON BRUSHES

2x



No.	specifications	
28229	for 28221 - hammer drill	1
28228	for 28225 - hammer drill	1
28223	for 28220 - hammer drill	1
28233	for 28230 - circular saw	1
28213	for 28210 - angle grinder	1
28218	for 28215 - angle grinder	1



ADAPTER SDS MAX NA SDS +

SDS MAX → SDS+	
No.	specification
20744	1



ADAPTER SDS+

SDS+	
No.	specification
20745	1



FESTA

ADAPTER SDS + NA BIT 1/4"

SDS+ →	
No.	Specification
20743	75 mm
	20



FESTA

CHUCK DRILL

1/2"	
No.	specification
20960	1-13 mm + 2 klíče, 1/2 - 20 UNF
20966	spare key
	3
	25



FESTA

DRILL CHUCK QUICKGRIP

1/2"	
No.	specification
20965	1,5 - 13 mm 1/2' - 20 UNF
	1



DRILL CHUCK QUICKGRIP

1/2"	
No.	specification
20961	1,5 - 13 mm 1/2' - 20 UNF
	1



ADAPTER FOR DRILLING 90°

No.	specification
20365	Ø 1 - 10 mm
	10



DRILL CHUCK QUICKGRIP FOR AKU

No.	specification
20963	Ø 1 - 6 mm
	10



FESTA

DUST EXTRACTOR

No.	specifications
28267	max. 70 mm
	1

DRILLING AND BORING CROW LEADER

No.	specification
20379	Ø 4, 5, 6, 7, 8, 10, 12 mm
	10

TECHNICAL SPECIFICATIONS



PRODUCT CATALOG NUMBER	28000	28001	28002	28003	28004
Name	Hammer drill cordless	Hammer drill cordless	Hammer drill cordless	Hammer drill cordless	Hammer drill cordless
Speed without load	I.0-550 min ⁻¹ II.0-2000 min ⁻¹	I.0-550 min ⁻¹ II.0-2000 min ⁻¹	I.0-550 min ⁻¹ II.0-2000 min ⁻¹	I.0-500 min ⁻¹ II.0-1800 min ⁻¹	I.0-500 min ⁻¹ II.0-1800 min ⁻¹
Number of hits	I.0-8800min ⁻¹ II.0-32000min ⁻¹	I.0-8800min ⁻¹ II.0-32000min ⁻¹	I.0-8800min ⁻¹ II.0-32000min ⁻¹	0-19200 min ⁻¹	0-19200 min ⁻¹
Number of strokes					
Torque	80 Nm	80 Nm	80 Nm	45 Nm	45 Nm
Max. battery voltage	20V	20V	20V	20V	20V
Number of torque stages	20+1+1	20+1+1	20+1+1	19+1+1	19+1+1
Clamping head	2-13 mm	2-13 mm	2-13 mm	2-13 mm	2-13 mm
Weight without battery	1,4kg	1,4kg	1,4kg	1,3kg	1,3kg
Cover	IPX0	IPX0	IPX0	IPX0	IPX0
Sound pressure level uncertainty K	LpA=97,04dB(A) K=5dB(A)	LpA=97,04dB(A) K=5dB(A)	LpA=97,04dB(A) K=5dB(A)	LpA=79dB(A) K=5dB(A)	LpA=79dB(A) K=5dB(A)
Sound power level uncertainty K	LwA=86,04dB(A) K=5dB(A)	LwA=86,04dB(A) K=5dB(A)	LwA=86,04dB(A) K=5dB(A)	LwA=90dB(A) K=5dB(A)	LwA=90dB(A) K=5dB(A)
Vibration without hammering into the metal	$\alpha_{h,D}=3,9m/s^2$ K=1,5m/s ²	$\alpha_{h,D}=3,9m/s^2$ K=1,5m/s ²	$\alpha_{h,D}=3,9m/s^2$ K=1,5m/s ²	$\alpha_{h,D}=2,4m/s^2$ K=1,5m/s ²	$\alpha_{h,D}=2,4m/s^2$ K=1,5m/s ²
Vibration without hammering into concrete	$\alpha_{h,ID}=11,4m/s^2$ K=1,5m/s ²	$\alpha_{h,ID}=11,4m/s^2$ K=1,5m/s ²	$\alpha_{h,ID}=11,4m/s^2$ K=1,5m/s ²	$\alpha_{h,ID}=7,5m/s^2$ K=1,5m/s ²	$\alpha_{h,ID}=7,5m/s^2$ K=1,5m/s ²
Maximum vibration, uncertainty K					
Strike force					
Drilling diameter					
Vibration into the concrete -main handle					
Vibration in concrete - additional handle					
Package contents	drill, 2.4 A charger, battery 2.0 Ah, 4.0 Ah battery, additional handle, suitcase	drill, charger 2.4 A, battery 2.0 Ah, additional handle, suitcase	drill	drill, 2.4 A charger, 2x 2.0 Ah battery, 6x bit, carrier, 6x drill, suitcase	drill



28005	28006	28007	28008	28021	28025
Drill cordless screwdriver	Drill cordless screwdriver	Drill cordless screwdriver	Cordless screwdriver	Cordless impact wrench	Cordless hammer drill
1.0-350 min ⁻¹ 11.0-1300 min ⁻¹	1.0-350 min ⁻¹ 11.0-1300 min ⁻¹	1.0-350 min ⁻¹ 11.0-1300 min ⁻¹	200 min ⁻¹	0-2000 min ⁻¹	1.0-300 min ⁻¹ 11.0-1000 min ⁻¹
					0-5000bpm
				0-3000bpm	
28 Nm	28 Nm	20 Nm	3 Nm	150 Nm	
20V	20V	12V	3.6V	20V	20V
19+1	19+1	19+1	6+1		
1-10mm	1-10mm	1-10mm	1/4" hexagon	1/4" hexagon	SDS+
0,9kg	0,9kg	*1kg	*0,4kg	1,2kg	1,7kg
IPX0	IPX0	IPX0	IPX0	IPX0	IPX0
LpA=69dB(A) K=5dB(A)	LpA=69dB(A) K=5dB(A)	LpA=78dB(A) K=5dB(A)	LpA=58dB(A) K=3dB(A)	LpA=92dB(A) K=3dB(A)	LpA=82,98dB(A) K=3dB(A)
LwA=80dB(A) K=5dB(A)	LwA=80dB(A) K=5dB(A)	LwA=67dB(A) K=5dB(A)	LwA=69dB(A) K=3dB(A)	LwA=103dB(A) K=3dB(A)	LwA=93,98dB(A) K=3dB(A)
$\alpha_{h,D} < 1,9m/s^2$ K=1,5m/s ²	$\alpha_{h,D} < 1,9m/s^2$ K=1,5m/s ²	$\alpha_{h,D} = 2,1m/s^2$ K=1,5m/s ²			
$\alpha_{h,D} = 10,1m/s^2$ K=1,5m/s ²	$\alpha_{h,D} = 10,1m/s^2$ K=1,5m/s ²	$\alpha_{h,D} = 7,5m/s^2$ K=1,5m/s ²			
			$\alpha_h < 2,5m/s^2$ K=1,5m/s ²	$\alpha_{h,D} = 15,9m/s^2$ K=1,5m/s ²	
					1,2J
					Steel: 10mm concrete: 20mm Wood: 20mm
					$\alpha_{h,(HD)} = 5,582m/s^2$ K=1,5m/s ²
					$\alpha_{h,(HD)} = 5,523m/s^2$ K=1,5m/s ²
drill, 2.4 A charger, 2x 2.0 Ah battery, 6x bit, carrier, 6x drill, suitcase	drill	drill, 2.4 A charger, 2x 1.5 Ah Battery, 6x bits, carrier, 6x drill, suitcase	screwdriver, charger 0.5 A, 1.5 Ah battery, 5x bit	tightener	drilling hammer, additional handle, depth stop

* weight is stated including battery

TECHNICAL SPECIFICATIONS



PRODUCT CATALOG NUMBER	28030	28032	28035	28040
Name	Cordless angle grinder	Cordless angle grinder	Cordless circular saw	Battery orbital sander
No-load speed	8500 min ⁻¹	8000 min ⁻¹	3650 min ⁻¹	10000 min ⁻¹
Number of oscillations without load				
Forward				
Number of pre-oscillation degrees				
Number of blades of the saw blade				
Maximum cut profile				
Maximum wheel diameter	125 mm	115 mm		
Support disc				125 mm
8 suction holes on the circle				65 mm
Eccentricity of the wheel				5 mm
Spindle thread size	M14	M14		
Maximum thickness of cut material	15 mm	15 mm		
Max. battery voltage	20V	20V	20V	20V
Adjustable cutting angle			0-45°	
Cut at an angle of 45 °			35 mm	
Cut at an angle of 90 °			50 mm	
Oscillation angle				
Dimension of delta grinding Base				
Vibration speed control				
Attaching the saw blade				
Stroke of the saw blade				
Base plate size			28 cm x 13,3 cm	
Weight without battery	1,6kg	1,6kg	2,7kg	1kg
Wheel diameter			165 mm	
Wheel body thickness			1,4 mm ± 5% mm	
Thickness SK of the blade blade			2,0 ± 5% mm	
Cutting width			2,3 ± 5% mm	
Diameter of the wheel hole after clamping			16 mm	
Number of disc teeth			24	
Cover	IPX0	IPX0	IPX0	IPX0
Nails-type, height x width x thickness				
Buckles-span x height x width x thickness				
Max. length of nails / clips into soft mats.				
Max. length of nails / clips into hard matt.				
Average / max. shooting frequency				
Operating time (4 AH battery, fully charged)				
Nail / staple magazine capacity				
Sound pressure level uncertainty K	LpA=87,1dB(A) K=3dB(A)	LpA=76,67dB(A) K=3dB(A)	LpA=84dB(A) K=3dB(A)	LpA=76dB(A) K=3dB(A)
Sound power level uncertainty K	LwA=98,1dB(A) K=3dB(A)	LwA=87,67dB(A) K=3dB(A)	LwA=95dB(A) K=3dB(A)	LwA=87dB(A) K=3dB(A)
Vibration when grinding the surface	$a_{h,AG}=8,363m/s^2$ K=1,5m/s ²	$a_{h,AG}=5,324m/s^2$ K=1,5m/s ²		
Vibration for cutting the board				
Vibration for sheet metal cutting				
Vibration for cutting Wood:en frames				
Maximum vibration, uncertainty K			$a_h < 2,5m/s^2$ K=1,5m/s ²	$a_h = 9,5m/s^2$ K=1,5m/s ²
Package contents	grinder, wheel cover, additional handle, wrench	grinder, wheel cover, additional handle, wrench	saw, depth stop, saw blade	grinder, dust collection bag



28045	28050	28055	28070
Cordless device multi-functional	Cordless jigsaw	Cordless reciprocating saw	Cordless nailer and stapler
5000-15000 min ⁻¹		0-3000 min ⁻¹	
		1°	
	3+0		
	0-2400 min ⁻¹		
	Steel: 6mm, Wood: 80mm	Wood: 100 mm, Steel: 5 mm, aluminum / copper: 20 mm	
20V		20V	20V
	bevel cut max. 45 °		
3°			
90 mm			
YES			
universal		universal	
		20 mm	
1kg	1,8kg	1,7kg	2,7kg
IPX0	IPX0	IPX0	IPX0
			F, 20-50mm x 1,2mm x 1,0 mm
			6,0mm x 19-40mm x 1,2mm x 1,0mm
			50 mm
			30 mm
			60/100 min ⁻¹
			1 hour
			100 pieces
LpA=78dB(A) K=3dB(A)	LpA=88,1dB(A) K=5dB(A)	LpA=87,33dB(A) K=5dB(A)	LpA=79,9dB(A) K=3dB(A)
LwA=89dB(A) K=3dB(A)	LwA=99,1dB(A) K=5dB(A)	LwA=98,33dB(A) K=5dB(A)	LwA=90,9dB(A) K=3dB(A)
	$\alpha_{h,B}=3,3m/s^2$ $K=1,5m/s^2$ $\alpha_{h,M}=4m/s^2$ $K=1,5m/s^2$	$\alpha_{h,B}=21,10m/s^2$ $K=1,5m/s^2$	
		$\alpha_{h,WB}=21,98m/s^2$ $K=1,5m/s^2$	
$\alpha_h=2,8m/s^2$ $K=1,5m/s^2$			$\alpha_h=1,39m/s^2$ $K=1,5m/s^2$
grinder, attachments (saw, scraper, carrier), 3x sandpaper P80	saw, guide rail, suction attachment, 2x saw blade	saw, 2x saw blade	nailer / stapler, 200x nails, 200x staples

TECHNICAL SPECIFICATIONS



PRODUCT CATALOG NUMBER	28075	36328	36329	28060	28076
Name	Air compressor AKU	Tile vibration leveling machine AKU	Tile vibration leveling machine AKU	Caulking gun AKU	Radio AKU DAB+ / FM / BT
Manometer	psi; bar; kgf/cm ² ; kPa				
Max. pressure	120 psi / 8,2 bar				
Hose	Ø 10,5 x 600 mm				
Suction cup		Ø 123 mm	Ø 123 mm		
Suction capacity		60 kg	60 kg		
Vibration		12 levels of adjustment 3500 - 8500 r/min	12 levels of adjustment 3500 - 8500 r/min		
Torque				6500 N	
Adjustable speed				0 - 8,7 mm/s	
Max. cartridge capacity				310 ml	
Tuner					DAB+ / FM
External input					Bluetooth 5.0, aux IN jack 3,5 mm
Power					2 x 15 W
Display					color 2,4"
Power supply					adapter 230 V, battery Li-ion FESTA share 20 V
Preset memory					30 (DAB+), 30 (FM)
Water resistance					IPX54
Weight		3 kg	3 kg	1,7 kg	1,3kg
Max. battery voltage	20 V	20 V	20 V	20 V	20 V
Package contents	Air compressor, car battery adapter, 3x inflation adap- tators	Tile vibration leveling machine, battery 2,0 Ah, charger, case	Tile vibration leveling machine, case	Caulking gun	Radio, adapter 230 V



PRODUCT CATALOG NUMBER	28221	28225	28220	28230	28210	28215
Name	Hammer drill SDS MAX	Hammer drill SDS+	Hammer drill	Circular saw	Angle grinder	Angle grinder
Performance	1 500 W	1 500 W	800 W	1 400 W	900 W	2 400 W
No-load speed	0 - 520 min-1	0 - 850 min-1	0 - 1 350 min-1	0 - 4 500 min-1	0 - 11 000 min-1	0 - 6 600 min-1
Number of hits	0 - 4 100	0 - 4 500	0 - 5 500			
Strike force	12 J	6 J	2,8 J			
Clamping head / shaft	SDS MAX	SDS+	SDS+ chuck 2 - 13 mm	20 mm	M14 / 22,2 mm	M14 / 22,2 mm
Adjustable cutting angle				0 - 45°		
Cut at an angle of 45°				42 mm		
Cut at an angle of 90°				63 mm		
Maximum wheel diameter				185 mm	125 mm	230 mm
Weight	6,8 kg	5 kg	3,2 kg	4,3 kg	2 kg	5,8 kg
Power cord length material	3 m rubber	2 m rubber	2 m rubber	2 m plastic	2 m rubber	2 m rubber
Package contents	hammer drill, side handle, depth gauge, wrench, plastic case, spare carbon brushes, accessories SDS MAX: <ul style="list-style-type: none"> ⌀ 16 x 280 mm 18 x 320 mm 	hammer drill, side handle, depth gauge, wrench, plastic case, spare carbon brushes, accessories SDS+: <ul style="list-style-type: none"> ⌀ 8, 10, 12 x 160 mm ▼ 20 x 250 mm 14 x 250 mm 	hammer drill, side handle, depth gauge, chuck ⌀ 2 - 13 mm, plastic case, vaseline, spare carbon brushes, accessories SDS+: <ul style="list-style-type: none"> ⌀ 6, 8, 10 x 160 mm ▼ 20 x 250 mm 14 x 250 mm 	circular saw, side guide, wrench, spare carbon brushes, saw blade <ul style="list-style-type: none"> ⌀ 185 x 2,3 / 1,3 x 20 mm 24T 	angle grinder, protective guard, side handle, wrench, spare carbon brushes	angle grinder, protective guard, side handle, wrench, spare carbon brushes

NEW

speed
1000 - 1850 min⁻¹

length
110 - 180 cm

power
750 W

disc
diameter
Ø 225 mm



ergonomic rubberized handle for a comfortable and secure grip



FESTO
POWER X TOOLS

DRYWALL SANDER

230V ~ 50Hz	750W	1000-1850min ⁻¹	Ø 225mm	110-180 cm
LED	4m	DRYWALL		



No. 28240 Specifications

1

NEW



FESTA
POWER X TOOLS

VACUUM CLEANER 30L

230 V ~50 Hz	1600 W	MAX 2000W	82dB	IPX4	3m	5m
-----------------	-----------	--------------	------	------	----	----

30L	WET DRY	AUTO ON-OFF	AUTOMATIC FILTER CLEANING	HEPA A
-----	------------	----------------	------------------------------	-----------

No.	Specifications	
28345		1
28346	HEPA filtr	1

NEW



**WEST
BERG**

VACUUM CLEANER 30L

230 V ~50 Hz	1200 W	3m	5m	SEMI-AUTOMATIC FILTER CLEANING
-----------------	-----------	----	----	-----------------------------------

30L	WET DRY	AUTO ON-OFF	HEPA A
-----	------------	----------------	-----------

No.	Specifications	
28340		1
28342	HEPA filtr	1

FESTA
 POWER X TOOLS

ELECTRIC MIXER FOR BUILDING MIXTURES

Input	1800 W
Voltage / frequency	230 V / 50 Hz
Gears	2
1st gear (idle speed)	0 - 450 rpm
2nd gear (idle speed)	0 - 790 rpm
Overload protection	Yes
Mixing basket diameter	100 mm
Broom length	570 mm
Weight	5,6 kg



No.	specification	
35311	stirrer	1
35318	spare carbon brushes	1
35319	spare stirrers - pair (L + R)	1

FESTA
 POWER X TOOLS

ELECTRIC MIXER 1600 W

Power input	1600 W
Voltage	230 V / 50 Hz
Number of gears	2
No-Load-speed	0 - 480 rpm
No-Load-speed	0 - 800 rpm
Protection	Yes
Thread	M 14
Mixing paddle	140 mm
Length of mixing paddle	600 mm
Weight	4,7 kg



No.	specification	
35310		1
35317	spare carbon brushes	1

FESTA
 POWER X TOOLS

ELECTRIC MIXER 850W

Power input	850 W
Voltage	230 V / 50 Hz
Number of gears	1
No-Load-speed	0 - 500 rpm
No-Load-speed	-
Protection	Yes
Thread	M 14
Mixing paddle	120 mm
Length of mixing paddle	600 mm
Weight	3,7 kg



No.	specification	
35300		1
35316	spare carbon brushes	1



NEW

WEST BERG

ELECTRIC MIXER 1600W

Power input	1600 W
Voltage	230 V / 50 Hz
Number of gears	2
No-Load-speed	180 - 400 ot./min.
No-Load-speed	300 - 700 ot./min.
Protection	Yes
Thread	M 14
Mixing paddle	140 mm
Length of mixing paddle	600 mm
Weight	5,4 kg

M14	Zn	CE	
No.	specification		
35305			1
35315	spare carbon brushes		1



NEW



FESTA
POWER X TOOLS

HIGH-PRESSURE CLEANER

230 V ~50 Hz	1800 W	IPX5	MAX 7 l/min	MAX 140 bar	MAX 50°C	5m	AUTO STOP	7,8 kg	
------------------------	---------------	-------------	--------------------	--------------------	-----------------	-----------	------------------	---------------	--

No.	Specifications	
45271		1



FESTA

HIGH PRESSURE CLEANER

230 V ~50 Hz	1500 W	MAX 120 bar	MAX 6 l/min	IPX5	5m	AUTO STOP	
------------------------	---------------	--------------------	--------------------	-------------	-----------	------------------	--

No.	dimensions	
45270	high pressure cleaner	1



POLYSTYRENE CUTTER

- voltage | frequency: 230 V / 50 Hz
- power consumption: 200 W
- length of cut: 137 cm
- height of cut: 35 cm
- protection: IP44
- angle of cut: 0° - 90°
- equipment: stand, foot switch, scaffold holder, 2x Ni-Cr cutting wire, cleaning brass brush, tools and fasteners, plastic box with wheels



No. Specification
35348



1

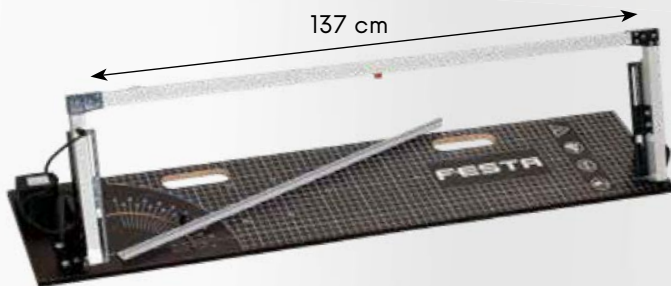
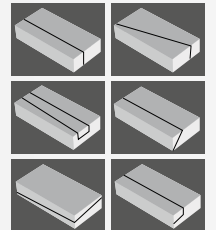
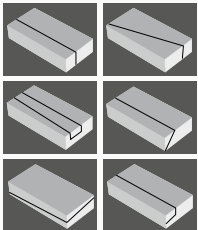

POLYSTYRENE CUTTER

- voltage | frequency: 230 V / 50 Hz
- power consumption: 200 W
- length of cut: 137 cm
- height of cut: 35 cm
- protection: IP44
- angle of cut: 0° - 90°



· equipment: Ni-Cr cutting wire, cleaning brass brush, inbus

No. specification
35345



1



POLYSTYRENE CUTTER

- voltage | frequency: 230 V / 50 Hz
- power consumption: 160 W
- length of cut: 117 cm
- height of cut: 35 cm
- protection: IP44
- angle of cut: 0° - 90°



· equipment: Ni-Cr cutting wire, cleaning brass brush, inbus

No. specification
35330



1



FESTA

POLYSTYRENE CUTTER

- voltage | frequency: 230 V / 50 Hz
- power consumption: 160 W
- length of cut: 117 cm
- height of cut: 52 cm
- protection: IP44
- angle of cut: 0° - 90°



· equipment: Ni-Cr cutting wire, cleaning brass brush, inbus

No.	specification	
35344		1



FESTA

FOOT SWITCH FOR POLYSTYRENE CUTTER

· for 35330, 35345, 35348



No.	Specification	
35334		1



FESTA

STAND FOR POLYSTYRENE CUTTER

· for 35330, 35345, 35348



No.	Specification	
35336		1



FESTA

REPLACEMENT SPRING FOR A POLYSTYRENE CUTTER

· for 35330, 35345, 35348



No.	Specification	
35332		1



FESTA

SPARE POWER ADAPTER FOR A POLYSTYRENE CUTTER

· for 35330, 35345, 35348



- voltage/frequency: 230 V / 50Hz
- output: 36 V / 5 A
- power: 200 W



No.	specification	
35347		1



FESTA

SCAFFOLD HOLDER FOR POLYSTYRENE CUTTER

· for 35330, 35345, 35348



No.	Specification	
35333		1



SPARE HEATING STRING CR-NI FOR POLYSTYRENE CUTTER



No.	specification	
35331	for cutter 117 cm	1
35346	for cutter 137 cm	1



Li-ion
technology

FESTA
POWER X TOOLS

CORDLESS POLYSTYRENE CUTTER

- battery 36 V, 1,5Ah Li-ion
- power 180 W
- temperature max 350 C°
- length of knife 20 cm
- equipment: 2 pcs battery, charger, blade, cleaning brass brush, inbus



No.	specification	
35323	electric polystyrene cutter	1
35328	Spare knife for polystyrene cutter 14 cm	1
35329	Spare knife for polystyrene cutter 25 cm	1



FESTA
POWER X TOOLS

ELECTRIC POLYSTYRENE CUTTER

- voltage / frequency 230 V/50 Hz
- power consumption 250 W
- temperature 50-600 C°
- length of knife 25 cm
- length of supply cable 3 m



· equipment: cleaning brass brush, inbus, dlades 25 and 30 cm, case

No.	specification	
35326	electric polystyrene cutter	1
35328	Spare knife for polystyrene cutter 14 cm	1
35329	Spare knife for polystyrene cutter 25 cm	1



GUIDE BAR FOR POLYSTYRENE CUTTER

· for 35323, 35326

No.	specification	
35327	Guide bar	1
35335	Spare knife - 30 cm	1

FESTA
POWER X TOOLS

POLYSTYRENE ELECTRIC CUTTER



· temperature regulation

No.	specification	
35325	220 W	1





FESTA

**WELDING INVERTER
TIG/MMA 160 A**

Voltage / frequency:	230 V / 50 Hz
Voltage free:	55 V
Regulatory range welding currents:	10 - 160 A
Diameter of electrode:	1,5 - 4,0 mm
Working cycle:	TIG- 160 A / 60%, MMA- 140 A / 60%
Protection class:	IP 21
Type of welding:	TIG/MMA
Dimensions:	405 x 165 x 270 mm
Technology:	Anti-stick, Arc-force, Hot start, Lift TIG
Weight:	6 kg



No.	specification
70040	Welding inverter TIG/MMA160A



FESTA

FESTA

SELFDARKENING WELDING HELMET

View size:	98 x 80 mm
Lens reaction time	1/25 000 s
Darkening	DIN 5-8 / 9-13
UV/IR protection	DIN 16
Optical class	1 1 1 2
Working cycle:	4
Power supply:	Solar cell + replaceable battery CR2450
Operating mode	Welding, grinding



No.	specification
70064	active
70066	replacement protective plexiglass



1
1



LCD display





FESTA

SELFDARKENING WELDING HELMET



No.	specification	quantity
70063	active	4



SELFDARKENING WELDING HELMET



No.	specification	quantity
70060	active	4



WELDING HELMET



No.	specification	quantity
70061		4



REPLACEMENT PROTECTIVE GLASS FOR WELDING HELMET

2x

No.	specification	quantity
70065	113 x 80 mm	20



WELDING GOGGLES



No.	specification	quantity
70062		1

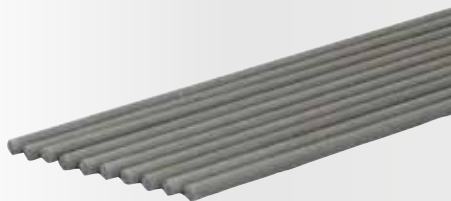

WELDING RUTILE ELECTRODE

certificated

No.	specification	množství	quantity
70021	Ø 2,0 x 300 mm	10 pcs	1
70020	Ø 2,0 x 300 mm	2,5 kg	8
70026	Ø 2,5 x 300 mm	10 pcs	1
70025	Ø 2,5 x 300 mm	2,5 kg	8
70033	Ø 3,2 x 350 mm	10 pcs	1
70032	Ø 3,2 x 350 mm	5 kg	4

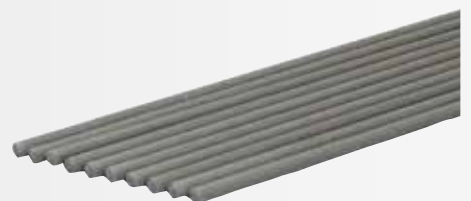

WELDING BASIC ELECTRODE

certificated

No.	specification	množství	quantity
70030	Ø 2,0 x 300 mm	2,5 kg	1
70031	Ø 2,0 x 300 mm	5 kg	1
70035	Ø 2,5 x 300 mm	2,5 kg	8
70036	Ø 2,5 x 300 mm	10 pcs	1
70037	Ø 3,2 x 350 mm	5 kg	5



WELDING HAMMER



No.	specification	quantity
19115	320 g	1



ELECTRODE HOLDER



No.	specification	quantity
70070	300 A	1



WELDING PLIERS



No.	specification	quantity
70075	300 A	1



FESTA

MAGNETIC WELDING HOLDER



No.	specification	nosnost	
70096	150 x 130 x 30 mm · 45°, 90°, 135°	25 kg	10

MAGNETIC WELDING HOLDER



No.	specification	nosnost	
70090	85 x 85 mm · 45°, 90°	9 kg	10



MAGNETIC WELDING HOLDER



No.	specification	nosnost	
70093	95 x 64 mm · 30°, 45°, 60°, 75°, 90°	9 kg	10
70094	120 x 90 mm · 30°, 45°, 60°, 75°, 90°	18 kg	10
70095	137 x 110 mm · 30°, 45°, 60°, 75°, 90°	27 kg	10

MAGNETIC WELDING HOLDER



No.	specification	nosnost	
70091	95 x 109 x 25 mm · 45°, 90°, 135°	13 kg	10
70092	130 x 150 x 32 mm · 45°, 90°, 135°	22 kg	5



FESTA
POWER X TOOLS

PIPE WELDER

- voltage / frequency 230 V / 50 Hz
- power consumption 750 / 1500 W
- temperature 0-300 C°
- extensions Ø 20,25,32,40,50,63 mm
- weight 1,6 kg



· package included: measuring tape, spirit level, screwdriver, hex key, 6x welding adapter, stand, shelf case

No.	
17182	1

FESTA
POWER X TOOLS

PIPE WELDER

- voltage / frequency 230 V / 50 Hz
- power consumption 800 / 1000 W
- temperature 0-300 C°
- extensions Ø 16, 20, 25, 32 mm
- weight 1 kg



· package included: hex key, 4x welding adapter, stand, shelf case

No.	
17183	1

FESTA

COMPRESSOR 6 L - OILLESS



Voltage / frequency:	230 V / 50Hz
Power consumption:	1,2 kW (1,5HP)
Tank volume :	6 l
Max. pressure:	8 Bar
Speed:	3900 min.
Suction power:	180 l/min.
Filling performance:	116 l/min.
Weight:	10 kg



No.	specification	
35360		1



COMPRESSOR 24 L OILLESS



Output:	1100 W
Power supply:	230 V / 50Hz
Run without load:	2850 min-1
Work pressure:	8 bar
Free Air Intake:	160 l / min
Type:	without oil
Storage capacity:	24 L
Weight:	23 kg



No.	specification	
35361	1,1 kW, 24 l	1



COMPRESSOR 24 L



Output:	1500 W
Power supply:	230 V / 50Hz
Run without load:	2850 min-1
Work pressure:	8 bar
Free Air Intake:	200 l / min
Type:	oleic
Storage capacity:	24 L
Weight:	24 kg



No.	specification	
35362	1,5 kW, 24 l	1



500 ml

FESTA

SPRAY GUN

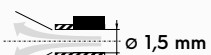

No.	specification	
48020	upper	1



600 ml

FESTA

SPRAY GUN

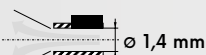

No.	specification	
48021	upper	1
48047	spare nozzle \varnothing 1,7 mm	1

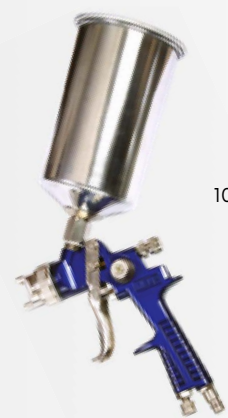

1000 ml

FESTA

SPRAY GUN



No.	specification	
48022	upper	1
48046	spare nozzle \varnothing 1,5 mm	1

FESTA
BLOW GUN

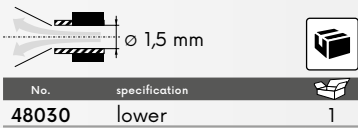

FESTA
SPRAY GUN FOR PAINTS AND PLASTERS

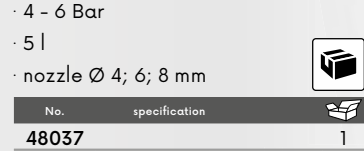

FESTA
BLOW GUN WITH ADAPTERS

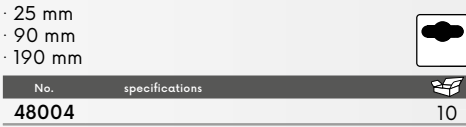

FESTA
BLOW GUN



FESTA
BLOW GUN

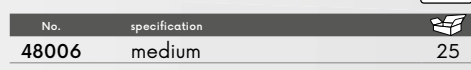

FESTA
BLOW GUN



FESTA
SPRAY GUN



FESTA
UNDER COATING GUN





FESTA

BLOW GUN WITH A DIGITAL PRESSURE GAUGE

- 0 - 10 bar
- LCD display
- bar, kPa, Psi, kgf/cm²

2x AAA

No.	specifications	
48011	0 - 10 bar	10



FESTA

RINSE GUN WITH MANOMETR

No.	specification	
48010		1



FESTA

COMPRESSOR SET

5x

- 1. spray gun with bottom reservoir
- 2. bladder gun with nanometer
- 3. spray gun with top shelf
- 4. blowing guns
- 5. hose with quick couplings

No.	specification	
48001		1



FESTA

COMPRESSOR SET

3x

- 1. blow guns with manometer
- 2. blow guns
- 3. hose with quick couplings

No.	specification	
48002		1

NEW

COMPRESSOR AIR HOSE FITTINGS

8x

No.	Specifications	
48013		1



FESTA

GUN HOSE INCLUDED CONNECTORS

No.	specification	
48043	5 m 8 atm ø 10 mm	1



FESTA

GUN HOSE INCLUDED CONNECTORS

No.	specification	
48040	5 m 8 atm ø 8 mm	1
48041	10 m 8 atm ø 8 mm	1
48042	15 m 8 atm ø 8 mm	1



FESTA

GUN HOSE INCLUDED CONNECTORS

No.	specification	
48031	5 m ø 9/15 mm	1
48032	10 m ø 9/15 mm	1
48033	15 m ø 9/15 mm	1
48034	20 m ø 9/15 mm	1

FESTA

FILTER

· max. pressure **10 bar**



No.	specification	
48008	G 1/4'	1

FESTA

PRESSURE REGULATOR

· working pressure **0 - 10 bar**



No.	specification	
48009	G 1/4'	1

FESTA

SPARE NOZZLE

· suitable for 48021



No.	specification	
48047	nozzle Ø 1,7 mm	1

FESTA

SPARE NOZZLE

· suitable for 48022



No.	specification	
48046	nozzle Ø 1,5 mm	1

TABLE OF WHITWORTHS PIPE THREADS

SIZE OF THREADS IN INCH	MAX. OUTER Ø OF THREADS
1/8	9,728
1/4	13,157
3/8	16,662
1/2	20,955
3/4	26,441
1	33,249

HOSE CONNECTOR WITH THREAD

No.	specification	
48075	1/4' out	10
48076	3/8' out	10
48077	1/2' out	10
48095	1/4' in	10
48096	3/8' in	10
48097	1/2' in	10

ADAPTER WITH THREAD

No.	specification	
48080	1/4' out	10
48081	3/8' out	10
48090	3/8' in	10
48091	1/4' in	10

DOUBLE ADAPTER

No.	specification	
48050	connection 1/4' out x 1/4' out	10
48051	reduction 1/4' out x 3/8' out	10

ADAPTER WITH THREAD

No.	specification	
48085	1/4' - 6 mm	10
48086	3/8' - 9 mm	10
48087	1/2' - 13 mm	10

HOSE CONNECTOR

No.	specification	
48070	1/4' - 6 mm	10
48071	3/8' - 9 mm	10
48072	1/2' - 13 mm	10

ADAPTER

No.	specification	
48054	3/8' out x 1/4' in	10
48055	1/2' out x 3/8' in	10
48056	reduction 3/8' out x 1/2' in	10
48057	reduction 1/4' out x 3/8' in	10

ADAPTER

No.	specification	
48060	Ø 6 mm - 1/8' out	10
48061	Ø 6 mm - 1/4' out	10
48062	Ø 6 mm - 3/8' out	10
48063	Ø 9 mm - 1/4' out	10
48064	Ø 9 mm - 3/8' out	10
48065	Ø 13 mm - 1/4' out	10
48066	Ø 13 mm - 3/8' out	10
48067	Ø 6 mm - 3/8' in	10
48068	Ø 9 mm - 3/8' in	10
48093	Ø 6 mm - 1/4' in	10
48094	Ø 9 mm - 1/4' in	10



FESTA
POWER X TOOLS

HEATING GUN

voltage	230V / 50Hz
power consumption	2000W
position of switch	0 - I (350°C) - II (550°C)
accessories	stainless extensions - 4 pcs



No.	specification	
35320	2000 W	1



FESTA
POWER X TOOLS

HEATING GUN WITH REGULATION OF TEMPERATURE AND AIR FLOW

voltage	230V / 50Hz
power consumption	2000W
position of switch	0 - I (50°C) - II (50 - 600°C)
air flow	120 - 500 l/min.
accessories	stainless extensions - 4 pcs



No.	specification	
35322	2000 W	1

· digital display



NEW



WEST BERG

SOLDERING GUN KIT

230V
~ 50Hz **175W**

No.	Specifications	
28275		1
28278	tips 3pcs	1



NEW



WEST BERG

SOLDERING IRON

230V
~ 50Hz **60W**

No.	Specifications	
28280		1
28282	tips 2pcs	1





FESTA
POWER X TOOLS

**HOT MELT GLUE GUN
WIRELESS**

· Ø glue stick 11,2 mm

230V
~ 50Hz **80W**



No. specification
89975

20

NEW

FESTA
POWER X TOOLS



**HOT MELT
GLUE GUN**

· Ø glue stick 7,2 mm

230V
~ 50Hz **12W**



No. Specifications
89775

1



**HOT MELT
GLUE GUN**

· Ø glue stick 7,2 mm

230V
~ 50Hz **15W**



No. specification
89970

25



**HOT MELT
GLUE GUN**

· Ø glue stick 11,2 mm

230V
~ 50Hz **60W**



No. specification
89973

20



HOT MELT GLUE STICK

No.	Ø	length		
89980	7,2 mm	100 mm	12 pcs	100
89988	7,2 mm	100 mm	1 kg	25



HOT MELT GLUE STICK

No.	Ø	length		
89985	11,2 mm	200 mm	10 pcs	50
89987	11,2 mm	200 mm	1 kg	25



HOT MELT GLUE STICK

No.	Ø	length		
89989	7,2 mm	100 mm	12 pcs	100
89990	11,2 mm	200 mm	10 pcs	50



ELECTRIC HEATER

voltage	230V ~50Hz
output	3300W
current load	14.5A
set up performance	30/1650/3300W
temperature range	5-40°C
protection	IP24
specification	27 x 25.5 x 40cm
weight	4.8 kg



- fast and efficient heating of cellars, workshps, shops, party tents, greenhouses etc.
- does not consume oxygen
- safe operation, continuous power control, room thermostat, fan.
- stainless steel heating element
- possibility of summer use for ventilation without heating
- low noise
- high-quality processing, materials, robust steel construction, easy and safe handling, long service life



No.	specification
35833	3,3 kW



1

GAS HEATER

gas	G30-I3B/P
gas pressure	0.7bar
voltage	230V 50Hz
engine output	25W
max. gas consumption	1.11 Kg/h
max. heat output	15KW
max. volume of hot air	300m3/h

- fast and efficient heating during construction worpcs, workshps
- it consumes oxygen!
- direct air heating with forced circulation - rapid heat gain
- safe operation, smooth power regulation
- thermostat and safety valve against overheating and leakage
- accessories included - controller and inlet gas hose
- high-quality processing, materials, robust steel construction, easy and safe handling with a long service life



No.	specification
35845	15 kW



1

GAS HEATER

gas	g30-i3b/p
gas pressure	1.5bar
voltage	230v 50hz
engine output	70w
max. gas consumption	2.2kg/h
max. heat output	30kw
max. volume of hot air	750m3/h

- fast and efficient heating during construction worpcs, workshps
- it consumes oxygen!
- direct air heating with forced circulation - rapid heat gain
- safe operation, smooth power regulation
- thermostat and safety valve against overheating and leakage
- accessories included - controller and inlet gas hose
- high-quality processing, materials, robust steel construction, easy and safe handling with a long service life



No.	specification
35850	30 kW



1



FESTA

LED LAMP ON BUILDING SITE



No.	specification	
37611		1



FESTA

LED LAMP ON BUILDING SITE

· max height 180 cm

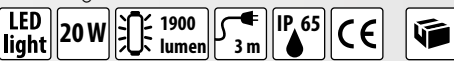

No.	specification	
37615	20 W	1
37616	2 x 20 W	1



NEW



FESTA
INDUSTRY

EXTENSION CORD REEL

- rubber - IP44
- H07RN-F3G - 2,5mm²
- equipped with a thermal fuse
- 16 A max. / 3680 W max.
- 4 socket

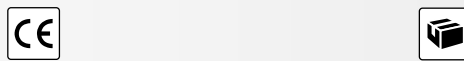

No.	specifications	
37740	length 25 m, 2,5 mm ²	2
37741	length 50 m, 2,5 mm ²	2

NEW



FESTA
INDUSTRY

EXTENSION CORD REEL

- rubber - IP44
- H05RR-F3G - 1,5mm²
- equipped with a thermal fuse
- 16 A max. / 3680 W max.
- 4 socket

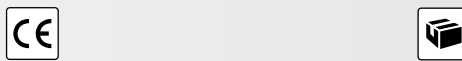

No.	specifications	
37750	length 25 m, 1,5 mm ²	2
37751	length 50 m, 1,5 mm ²	2



FESTA

EXTENSION CORD REEL

- IP20
- H05VV - F3G 1,5mm²
- equipped with a thermal fuse
- Welding power: 1000 W max.
- Output power: 3000 W max.
- 4 sockets



No.	specification	
37760	length 25 m, 1,5 mm ²	2
37761	length 50 m, 1,5 mm ²	2

FESTA
INDUSTRY

EXTENSION CORD

- rubber - IP44
- H07RN-F3G - 1,5mm²
- 16 A max. / 3680 W max.



No.	specifications	
37744	length 5 m, 1,5 mm ²	8
37745	length 10 m, 1,5 mm ²	4
37746	length 20 m, 1,5 mm ²	8
37747	length 30 m, 1,5 mm ²	8

NEW

FESTA

EXTENSION CORD

- IP20
- H05VV-F3G - 1,5mm²
- 16 A max. / 3680 W max.



No.	specifications	
37730	length 10 m, 1,5 mm ²	8
37731	length 20 m, 1,5 mm ²	4
37732	NEW length 30 m, 1,5 mm ²	8
37733	NEW length 40 m, 1,5 mm ²	4





56

DRILLS FOR METAL



63

DRILLS, HOLESAWS,
ROUTER BITS



67

MASONRY DRILLS, CHISELS



71

DIAMOND HOLESAW



74

DIAMANT DISCS



76

CUTTING AND GRINDING
DISCS



80

ROTATING AND GRINDING
BRUSHES

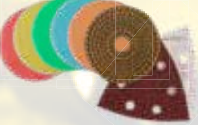

82

GRINDING DISC AND
PAPERS



86

JIG SAW BLADES

DRILLS, CUTTING
AND DRILLING TOOLS

54 - 93



FESTA

FULLY GROUND DRILL HSS-G

Co 5%, W 6%
Mo 5%, Cr 4%, V 4%

HSS

DIN 338

135°

INOX

1400 MPa



No.	specification		No.	specification		No.	specification	
22510	Ø 1,00 mm	1	22548	Ø 4,80 mm	1	22590	Ø 9,00 mm	1
22515	Ø 1,50 mm	1	22550	Ø 5,00 mm	1	22595	Ø 9,50 mm	1
22520	Ø 2,00 mm	1	22555	Ø 5,50 mm	1	22600	Ø 10,00 mm	1
22525	Ø 2,50 mm	1	22560	Ø 6,00 mm	1	22602	Ø 10,20 mm	1
22530	Ø 3,00 mm	1	22565	Ø 6,50 mm	1	22605	Ø 10,50 mm	1
22532	Ø 3,20 mm	1	22568	Ø 6,80 mm	1	22610	Ø 11,00 mm	1
22535	Ø 3,50 mm	1	22570	Ø 7,00 mm	1	22615	Ø 11,50 mm	1
22540	Ø 4,00 mm	1	22575	Ø 7,50 mm	1	22620	Ø 12,00 mm	1
22542	Ø 4,20 mm	1	22580	Ø 8,00 mm	1	22625	Ø 12,50 mm	1
22545	Ø 4,50 mm	1	22585	Ø 8,50 mm	1	22630	Ø 13,00 mm	1

FESTA

FULLY GROUND DRILL HSS-G W9%

W 9%, Mo 3%
Cr 4%, V 1%

HSS

DIN 338

INOX

1100 MPa



MOQ



No.	set content		No.	set content		No.	set content		No.	set content	
19530	Ø 1,00 mm	10	19579	Ø 5,90 mm	5	19612	Ø 9,20 mm	5	19639	Ø 11,90 mm	3
19535	Ø 1,50 mm	10	19580	Ø 6,00 mm	5	19613	Ø 9,30 mm	5	19640	Ø 12,00 mm	3
19536	Ø 1,60 mm	10	19585	Ø 6,50 mm	5	19614	Ø 9,40 mm	5	19641	Ø 12,10 mm	3
19537	Ø 1,70 mm	10	19586	Ø 6,60 mm	5	19615	Ø 9,50 mm	3	19642	Ø 12,20 mm	3
19538	Ø 1,80 mm	10	19587	Ø 6,70 mm	5	19616	Ø 9,60 mm	3	19643	Ø 12,30 mm	3
19539	Ø 1,90 mm	10	19588	Ø 6,80 mm	5	19617	Ø 9,70 mm	3	19644	Ø 12,40 mm	3
19540	Ø 2,00 mm	10	19589	Ø 6,90 mm	5	19618	Ø 9,80 mm	3	19645	Ø 12,50 mm	3
19543	Ø 2,30 mm	10	19590	Ø 7,00 mm	5	19619	Ø 9,90 mm	3	19646	Ø 12,60 mm	1
19544	Ø 2,40 mm	10	19591	Ø 7,10 mm	5	19620	Ø 10,00 mm	3	19647	Ø 12,70 mm	1
19545	Ø 2,50 mm	10	19593	Ø 7,30 mm	5	19621	Ø 10,10 mm	3	19648	Ø 12,80 mm	1
19550	Ø 3,00 mm	10	19594	Ø 7,40 mm	5	19622	Ø 10,20 mm	3	19649	Ø 12,90 mm	1
19552	Ø 3,20 mm	10	19595	Ø 7,50 mm	5	19623	Ø 10,30 mm	3	19650	Ø 13,00 mm	1
19554	Ø 3,40 mm	10	19596	Ø 7,60 mm	5	19624	Ø 10,40 mm	3	19651	Ø 13,20 mm R13	1
19555	Ø 3,50 mm	10	19597	Ø 7,70 mm	5	19625	Ø 10,50 mm	3	19652	Ø 13,50 mm R13	1
19557	Ø 3,70 mm	10	19598	Ø 7,80 mm	5	19626	Ø 10,60 mm	3	19653	Ø 14,00 mm R13	1
19559	Ø 3,90 mm	10	19599	Ø 7,90 mm	5	19627	Ø 10,70 mm	3	19654	Ø 14,50 mm R13	1
19560	Ø 4,00 mm	10	19600	Ø 8,00 mm	5	19628	Ø 10,80 mm	3	19655	Ø 15,00 mm R13	1
19562	Ø 4,20 mm	10	19601	Ø 8,10 mm	5	19629	Ø 10,90 mm	3	19656	Ø 15,50 mm R13	1
19564	Ø 4,40 mm	10	19603	Ø 8,30 mm	5	19630	Ø 11,00 mm	3	19657	Ø 16,00 mm R13	1
19565	Ø 4,50 mm	10	19604	Ø 8,40 mm	5	19631	Ø 11,10 mm	3	19658	Ø 16,50 mm R13	1
19567	Ø 4,70 mm	10	19605	Ø 8,50 mm	5	19632	Ø 11,20 mm	3	19659	Ø 17,00 mm R13	1
19568	Ø 4,80 mm	10	19606	Ø 8,60 mm	5	19633	Ø 11,30 mm	3	19660	Ø 17,50 mm R13	1
19570	Ø 5,00 mm	5	19607	Ø 8,70 mm	5	19634	Ø 11,40 mm	3	19661	Ø 18,00 mm R13	1
19574	Ø 5,40 mm	5	19608	Ø 8,80 mm	5	19635	Ø 11,50 mm	3	19662	Ø 18,50 mm R13	1
19575	Ø 5,50 mm	5	19609	Ø 8,90 mm	5	19636	Ø 11,60 mm	3	19663	Ø 19,00 mm R13	1
19576	Ø 5,60 mm	5	19610	Ø 9,00 mm	5	19637	Ø 11,70 mm	3	19664	Ø 19,50 mm R13	1
19577	Ø 5,70 mm	5	19611	Ø 9,10 mm	5	19638	Ø 11,80 mm	3	19665	Ø 20,00 mm R13	1
19578	Ø 5,80 mm	5									

FESTA

BOX WITH FULLY GROUND DRILLS HSS-G W 9%

W 9%, Mo 3%
Cr 4%, V 1%

HSS

DIN 338

INOX

1100 MPa



No.	specification	
19669		1
90191	without drills	1

No.	set content	No.	set content
19530	Ø 1,00 mm 20x	19585	Ø 6,50 mm 15x
19535	Ø 1,50 mm 20x	19590	Ø 7,00 mm 15x
19540	Ø 2,00 mm 20x	19595	Ø 7,50 mm 15x
19545	Ø 2,50 mm 20x	19600	Ø 8,00 mm 15x
19550	Ø 3,00 mm 20x	19605	Ø 8,50 mm 15x
19552	Ø 3,20 mm 20x	19610	Ø 9,00 mm 15x
19555	Ø 3,50 mm 20x	19615	Ø 9,50 mm 15x
19558	Ø 3,80 mm 20x	19620	Ø 10,00 mm 15x
19560	Ø 4,00 mm 30x	19625	Ø 10,50 mm 6x
19562	Ø 4,20 mm 20x	19630	Ø 11,00 mm 6x
19565	Ø 4,50 mm 20x	19635	Ø 11,50 mm 6x
19568	Ø 4,80 mm 20x	19640	Ø 12,00 mm 6x
19570	Ø 5,00 mm 15x	19645	Ø 12,50 mm 6x
19575	Ø 5,50 mm 15x	19650	Ø 13,00 mm 6x
19580	Ø 6,00 mm 30x		

FESTA

FULLY GROUND DRILL

W 4%, Mo 3%
Cr 4%, V 1%

HSS

DIN
338



ALU

900
MPa



MOQ

No.	specification		No.	specification		No.	specification		No.	specification	
19670	Ø 0,6 mm	10	19703	Ø 4,0 mm	10	19736	Ø 7,3 mm	10	19769	Ø 10,6 mm	5
19671	Ø 0,8 mm	10	19704	Ø 4,1 mm	10	19737	Ø 7,4 mm	10	19770	Ø 10,7 mm	5
19672	Ø 0,9 mm	10	19705	Ø 4,2 mm	10	19738	Ø 7,5 mm	10	19771	Ø 10,8 mm	5
19673	Ø 1,0 mm	10	19706	Ø 4,3 mm	10	19739	Ø 7,6 mm	10	19772	Ø 11,0 mm	5
19674	Ø 1,1 mm	10	19707	Ø 4,4 mm	10	19740	Ø 7,7 mm	10	19773	Ø 11,2 mm	5
19675	Ø 1,2 mm	10	19708	Ø 4,5 mm	10	19741	Ø 7,8 mm	10	19774	Ø 11,3 mm	5
19676	Ø 1,3 mm	10	19709	Ø 4,6 mm	10	19742	Ø 7,9 mm	10	19775	Ø 11,4 mm	5
19677	Ø 1,4 mm	10	19710	Ø 4,7 mm	10	19743	Ø 8,0 mm	10	19776	Ø 11,5 mm	5
19678	Ø 1,5 mm	10	19711	Ø 4,8 mm	10	19744	Ø 8,1 mm	10	19777	Ø 11,6 mm	5
19679	Ø 1,6 mm	10	19712	Ø 4,9 mm	10	19745	Ø 8,2 mm	10	19778	Ø 11,7 mm	5
19680	Ø 1,7 mm	10	19713	Ø 5,0 mm	10	19746	Ø 8,3 mm	10	19779	Ø 11,8 mm	5
19681	Ø 1,8 mm	10	19714	Ø 5,1 mm	10	19747	Ø 8,4 mm	10	19780	Ø 11,9 mm	5
19682	Ø 1,9 mm	10	19715	Ø 5,2 mm	10	19748	Ø 8,5 mm	10	19781	Ø 12,0 mm	5
19683	Ø 2,0 mm	10	19716	Ø 5,3 mm	10	19749	Ø 8,6 mm	5	19782	Ø 12,2 mm	5
19684	Ø 2,1 mm	10	19717	Ø 5,4 mm	10	19750	Ø 8,7 mm	5	19783	Ø 12,5 mm	5
19685	Ø 2,2 mm	10	19718	Ø 5,5 mm	10	19751	Ø 8,8 mm	5	19784	Ø 12,8 mm	5
19686	Ø 2,3 mm	10	19719	Ø 5,6 mm	10	19752	Ø 8,9 mm	5	19785	Ø 12,9 mm	5
19687	Ø 2,4 mm	10	19720	Ø 5,7 mm	10	19753	Ø 9,0 mm	5	19786	Ø 13,0 mm	5
19688	Ø 2,5 mm	10	19721	Ø 5,8 mm	10	19754	Ø 9,1 mm	5	19787	Ø 13,2 mm R13	5
19689	Ø 2,6 mm	10	19722	Ø 5,9 mm	10	19755	Ø 9,2 mm	5	19788	Ø 13,5 mm R13	5
19690	Ø 2,7 mm	10	19723	Ø 6,0 mm	10	19756	Ø 9,3 mm	5	19789	Ø 14,0 mm R13	5
19691	Ø 2,8 mm	10	19724	Ø 6,1 mm	10	19757	Ø 9,4 mm	5	19790	Ø 14,5 mm R13	5
19692	Ø 2,9 mm	10	19725	Ø 6,2 mm	10	19758	Ø 9,5 mm	5	19791	Ø 15,0 mm R13	5
19693	Ø 3,0 mm	10	19726	Ø 6,3 mm	10	19759	Ø 9,6 mm	5	19792	Ø 15,5 mm R13	5
19694	Ø 3,1 mm	10	19727	Ø 6,4 mm	10	19760	Ø 9,7 mm	5	19793	Ø 16,0 mm R13	5
19695	Ø 3,2 mm	10	19728	Ø 6,5 mm	10	19761	Ø 9,8 mm	5	19794	Ø 16,5 mm R13	5
19696	Ø 3,3 mm	10	19729	Ø 6,6 mm	10	19762	Ø 9,9 mm	5	19795	Ø 17,0 mm R13	5
19697	Ø 3,4 mm	10	19730	Ø 6,7 mm	10	19763	Ø 10,0 mm	5	19796	Ø 17,5 mm R13	5
19698	Ø 3,5 mm	10	19731	Ø 6,8 mm	10	19764	Ø 10,1 mm	5	19797	Ø 18,0 mm R13	5
19699	Ø 3,6 mm	10	19732	Ø 6,9 mm	10	19765	Ø 10,2 mm	5	19798	Ø 18,5 mm R13	5
19700	Ø 3,7 mm	10	19733	Ø 7,0 mm	10	19766	Ø 10,3 mm	5	19799	Ø 19,0 mm R13	5
19701	Ø 3,8 mm	10	19734	Ø 7,1 mm	10	19767	Ø 10,4 mm	5	19800	Ø 19,5 mm R13	5
19702	Ø 3,9 mm	10	19735	Ø 7,2 mm	10	19768	Ø 10,5 mm	5	19801	Ø 20,0 mm R13	5

FESTA

BOX WITH FULLY GROUND DRILLS HSS 4341

W 4%, Mo 3%
Cr 4%, V 1%

HSS

DIN
338



ALU

900
MPa



No.	specification	
19802		1
90192	without drills	1

No.	set content	No.	set content
19673	Ø 1,00 mm 20x	19728	Ø 6,50 mm 20x
19678	Ø 1,50 mm 20x	19733	Ø 7,00 mm 10x
19683	Ø 2,00 mm 20x	19738	Ø 7,50 mm 10x
19688	Ø 2,50 mm 20x	19743	Ø 8,00 mm 10x
19693	Ø 3,00 mm 30x	19748	Ø 8,50 mm 10x
19695	Ø 3,20 mm 30x	19753	Ø 9,00 mm 10x
19698	Ø 3,50 mm 30x	19758	Ø 9,50 mm 10x
19701	Ø 3,80 mm 30x	19763	Ø 10,00 mm 10x
19703	Ø 4,00 mm 30x	19768	Ø 10,50 mm 10x
19705	Ø 4,20 mm 30x	19772	Ø 11,00 mm 10x
19708	Ø 4,50 mm 30x	19776	Ø 11,50 mm 10x
19711	Ø 4,80 mm 30x	19781	Ø 12,00 mm 10x
19713	Ø 5,00 mm 20x	19783	Ø 12,50 mm 10x
19718	Ø 5,50 mm 20x	19786	Ø 13,00 mm 5x
19723	Ø 6,00 mm 20x		

FESTA

DRILL HSS EXTENDED

W 4%, Mo 3%
Cr 4%, V 1%

HSS

DIN
340



ALU



MOQ

No.	specification		No.	specification		No.	specification	
20220	Ø 2,0 mm x 85 mm	1	20245	Ø 4,5 mm x 126 mm	1	20280	Ø 8,0 mm x 165 mm	1
20225	Ø 2,5 mm x 95 mm	1	20250	Ø 5,0 mm x 132 mm	1	20290	Ø 9,0 mm x 175 mm	1
20230	Ø 3,0 mm x 100 mm	1	20255	Ø 5,5 mm x 139 mm	1	20296	Ø 10,0 mm x 184 mm	1
20235	Ø 3,5 mm x 110 mm	1	20260	Ø 6,0 mm x 139 mm	1			
20240	Ø 4,0 mm x 119 mm	1	20270	Ø 7,0 mm x 156 mm	1			

TITANIUM DRILL HSS TIN

* titanium surface to enhance performance and durability

TiN HSS DIN 338



No.	specification	
20400	Ø 1,0 mm	1
20401	Ø 1,5 mm	1
20402	Ø 2,0 mm	1
20403	Ø 2,5 mm	1
20404	Ø 3,0 mm	1
20405	Ø 3,2 mm	1
20406	Ø 3,5 mm	1
20407	Ø 3,8 mm	1
20408	Ø 4,0 mm	1
20409	Ø 4,2 mm	1
20410	Ø 4,5 mm	1

No.	specification	
20411	Ø 4,8 mm	1
20412	Ø 5,0 mm	1
20413	Ø 5,5 mm	1
20414	Ø 6,0 mm	1
20415	Ø 6,5 mm	1
20416	Ø 6,8 mm	1
20417	Ø 7,0 mm	1
20418	Ø 7,5 mm	1
20419	Ø 8,0 mm	1
20420	Ø 8,5 mm	1
20421	Ø 9,0 mm	1

No.	specification	
20422	Ø 9,5 mm	1
20423	Ø 10,0 mm	1
20424	Ø 10,2 mm	1
20425	Ø 10,5 mm	1
20426	Ø 11,0 mm	1
20427	Ø 11,5 mm	1
20428	Ø 12,0 mm	1
20429	Ø 12,5 mm	1
20430	Ø 13,0 mm	1

DRILL HSS

HSS DIN 338

ALU



No.	specification	
19841	Ø 4,1 mm 5 ks	10
19842	Ø 4,2 mm 5 ks	10
19845	Ø 4,5 mm 5 ks	10
19885	Ø 8,5 mm 1 ks	10
19895	Ø 9,5 mm 1 ks	10



FESTA

FULLY GROUND DRILL SET HSS

W 9%, Mo 3% Cr 4%, V 1% HSS DIN 338

13x



No.	specification	
20333	Ø 1,5 - 6,5 mm	20



FESTA

FULLY GROUND DRILL SET HSS

W 9%, Mo 3% Cr 4%, V 1% HSS DIN 338

19x



No.	specification	
20334	Ø 1,0 - 10,0 mm	20



FESTA

FULLY GROUND DRILL SET HSS

W 9%, Mo 3% Cr 4%, V 1% HSS DIN 338

25x



No.	specification	
20335	Ø 1,0 - 13,0 mm	5



FESTA

DRILL SET

W 4%, Mo 3% Cr 4%, V 1% HSS DIN 338

13x



No.	specification	
20336	Ø 1,5 - 6,5 mm	1



FESTA

DRILL SET

W 4%, Mo 3% Cr 4%, V 1% HSS DIN 338

19x



No.	specification	
20337	Ø 1,0 - 10,0 mm	20



FESTA

DRILL SET

W 4%, Mo 3% Cr 4%, V 1% HSS DIN 338

25x



No.	specification	
20338	Ø 1,0 - 13,0 mm	10

FESTA

DRILL SET

TiN



9x



No.	specification
20317	Ø 5-6-8 mm



20

FESTA

DRILL SET WITH HEXAGON STALK

1/4" HSS



7x



No.	specification
20316	Ø 1,5-2-3-4-5-5,5-6 mm



20



DRILL SET

HSS DIN 338



19x

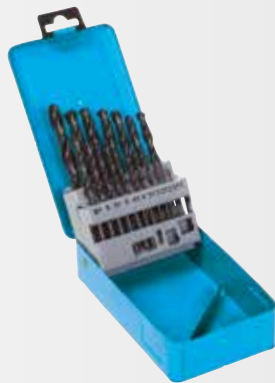

No.	specification
20305	Ø 1,0 - 13,0 mm

25

DRILL SET

HSS DIN 338



25x



No.	specification
20311	Ø 1,0 - 13,0 mm

10

DRILL SET

HSS DIN 338



13x



No.	specification
20300	Ø 1,5 - 6,5 mm

50

DRILL SET

HSS DIN 338



19x



No.	specification
20310	Ø 1 - 13 mm

10

DRILL AND BIT SET

- wood drill Ø 3 · 4 · 5 · 6 · 8 mm
- metal drill Ø 1 · 1,5 · 2 · 2,5 · 3 · 3,5 · 4 · 4,5 · 5 · 5,5 · 6 · 7 · 8 · 10 mm
- masonry drill Ø 4 · 5 · 6 · 8 · 10 mm
- flat wooden drill Ø 16 · 22 · 25 mm
- holesaw Ø 32 · 38 · 44 · 54 mm
- depth stops Ø 6 · 8 · 10 mm
- centre punch
- drill bit diameter measuring gauge

- bit 25 mm
 - ⊖ S 3 · 4 · 4 · 5 · 5 · 6 · 6 · 7
 - ⊕ PH 0 · 0 · 1 · 1 · 2 · 2 · 2 · 3 · 3
 - ⊗ PZ 0 · 0 · 1 · 1 · 2 · 2 · 2 · 3 · 3
 - H 2 · 2,5 · 3 · 3,5 · 4 · 5 · 6
 - ⊗ T 10 · 15 · 20 · 25 · 27 · 30 · 40
- bit 50 mm
 - ⊖ S 4 · 5 · 6 · 6
 - ⊕ PH 1 · 2 · 2 · 3
 - ⊗ PZ 1 · 2 · 2 · 3
- adapter
 - 4 · 5 · 6 · 7 · 8 · 9 · 10 · 13 mm
- deburrer
- bit holder



DRILL SET

HSS DIN 338



19x

100x

No.	specification	No.	specification
20340		20315	Ø 1 - 10 mm

DRILL SET

TiN HSS DIN 338



19x



DRILL SET

HSS DIN 338



19x



No.	specification	No.	specification
20320	Ø 1 - 10 x 0,5 mm	20321	Ø 1 - 10 x 0,5 mm



DRILL SHARPENER

No.	specification
20380	for Ø 3,5 - 10 mm

FESTA HOLESAW BI-METAL



No.	specification
24419	Ø 19 mm
24420	Ø 20 mm
24422	Ø 22 mm
24425	Ø 25 mm
24429	Ø 29 mm
24432	Ø 32 mm
24435	Ø 35 mm
24437	Ø 37 mm
24444	Ø 44 mm
24451	Ø 51 mm
24457	Ø 57 mm
24464	Ø 64 mm
24468	NEW Ø 68 mm
24476	Ø 76 mm
24483	Ø 83 mm



FESTA

HOLESAW HOLDER

No.	specification
24410	for Ø 14 - 30 mm



FESTA

HOLESAW HOLDER

No.	specification
24411	for Ø 32 - 152 mm



FESTA

SPARE DRILL FOR HOLESAW HOLDER

No.	specification
24412	



FESTA

DRILLS HSS,
HOLESAW BI-METAL
SET

HSS



9x

No.	specification
24750	Ø 19, 22, 29, 38, 44, 57 mm



10



FESTA

DRILLS HSS,
HOLESAW BI-METAL
SET

HSS



13x

No.	specification
24751	Ø 19, 22, 29, 35, 38, 44, 51, 57, 64 mm



10



FESTA

STEP DRILL TIN

TiN

HSS



No.	specification
20489	Ø 4 - 12 mm 9 steps 20
20490	Ø 4 - 20 mm 9 steps 10
20491	Ø 5 - 35 mm 13 steps 10
20492	Ø 7 - 40,5 mm 13 steps 5



FESTA

STEP DRILL SET TIN

TiN

HSS



3x

No.	specification
20495	Ø 4 - 12, 4 - 20, 4 - 32 mm



1



STEP DRILL HSS

HSS



No.	specification
20487	Ø 4 - 20 mm 9 steps 10
20488	Ø 5 - 35 mm 13 steps 10
20494	Ø 4 - 32 mm 15 steps 10
20493	Ø 7 - 40,5 mm 13 steps 1



STEP DRILL SET

HSS



3x

No.	specification
20496	Ø 4 - 12, 4 - 20, 4 - 32 mm



1





FESTA
SCREW EXTRACTORS

- ∅ 4 mm ∅ 11 mm
- ∅ 4,5 mm ∅ 15 mm
- ∅ 6,5 mm ∅ 19 mm
- ∅ 7,5 mm ∅ 24 mm

8x	
No.	specification
20387	5



FESTA
SCREW EXTRACTORS

- ∅ 4 mm
- ∅ 4,5 mm
- ∅ 6 mm
- ∅ 7,5 mm
- ∅ 11 mm

5x	
No.	specification
20386	10



FESTA
SCREW EXTRACTORS

- ∅ 4 mm
- ∅ 4,5 mm
- ∅ 6 mm
- ∅ 7,5 mm
- ∅ 11 mm

5x	
No.	specification
20385	10



TAPS RATCHET

No.	specification	
20397	M3 - M8	10



FESTA
DIE WRENCH

DIN 225		
No.	specification	
20396	25 x 9 mm	10



FESTA
TAP WRENCH

DIN 1814		
No.	specification	
20394	M5 - M20	10
20395	1 - 1/2', M3 - M12	10



FESTA
TAPS AND DIES SET

32x		
No.	specification	
20391	M 3, 4, 5, 6, 8, 10, 12 mm	1



FESTA
TAPS SET

21x		
No.	specification	
20390	M 3, 4, 5, 6, 8, 10, 12 mm	1

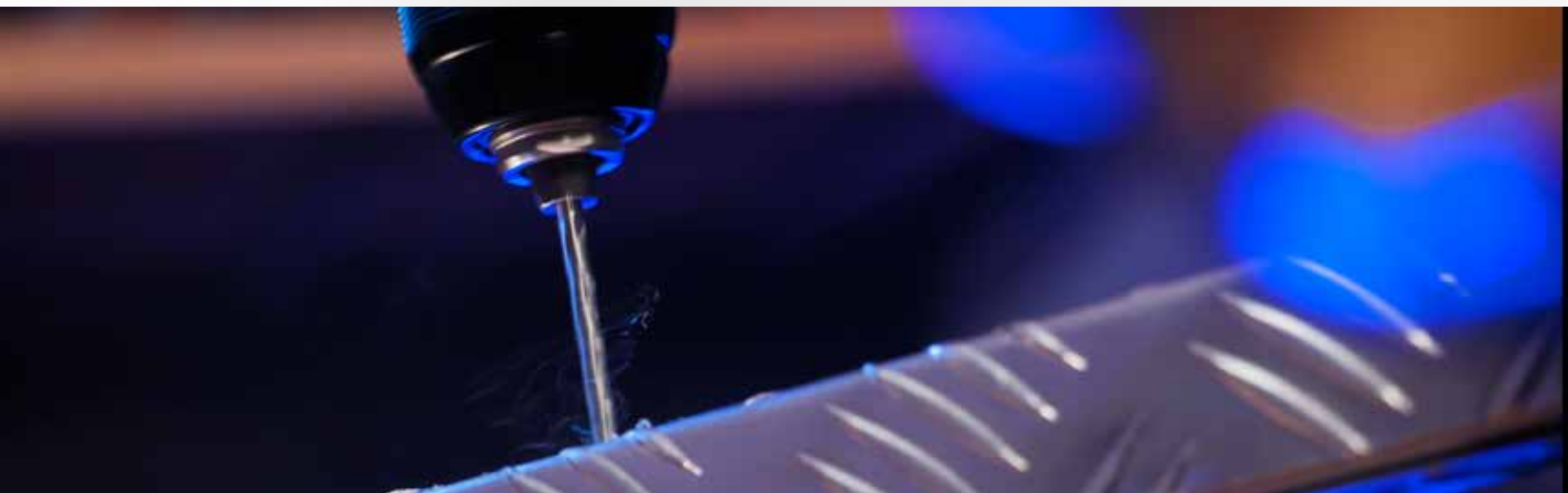

NEW

FESTA

FORSTNER DRILL BIT

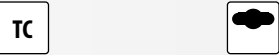

No.	Specification	
21531	Ø 15 mm	1
21532	Ø 20 mm	1
21533	Ø 25 mm	1
21534	Ø 30 mm	1
21535	Ø 35 mm	1
21536	Ø 40 mm	1



FESTA

FESTA

AUGER BIT



No.	specification	
20980	Ø 6 x 230 mm	1
20957	Ø 6 x 300 mm	1
20981	Ø 8 x 230 mm	1
20958	Ø 8 x 300 mm	1
20982	Ø 10 x 230 mm	1
20896	Ø 10 x 300 mm	1
20913	Ø 10 x 450 mm	1
20983	Ø 12 x 230 mm	1
20897	Ø 12 x 300 mm	1
20915	Ø 12 x 450 mm	1
20920	Ø 12 x 600 mm	1
20898	Ø 14 x 300 mm	1
20916	Ø 14 x 450 mm	1
20921	Ø 14 x 600 mm	1

No.	specification	
20984	Ø 16 x 230 mm	1
20899	Ø 16 x 300 mm	1
20917	Ø 16 x 450 mm	1
20922	Ø 16 x 600 mm	1
20918	Ø 18 x 450 mm	1
20923	Ø 18 x 600 mm	1
20919	Ø 20 x 450 mm	1
20924	Ø 20 x 600 mm	1
20724	Ø 22 x 450 mm	1
20725	Ø 24 x 450 mm	1
20726	Ø 26 x 450 mm	1
20727	Ø 28 x 450 mm	1
20728	Ø 30 x 450 mm	1

FESTA

AUGER BIT SET



5x

No.	specification	
20911	Ø 8, 10, 12, 14, 16 x 460 mm	10



FESTA

AUGER BIT SET



6x

No.	specification	
20912	Ø 6, 8, 10, 12, 16, 20 x 230 mm	10



DRILL FOR WOOD



No.	specification	
20729	Ø 6 x 400 mm	1
20731	Ø 8 x 400 mm	1
20736	Ø 8 x 600 mm	1
20730	Ø 10 x 400 mm	1
20737	Ø 10 x 600 mm	1



No.	specification	
20732	Ø 12 x 400 mm	1
20738	Ø 12 x 600 mm	1
20733	Ø 14 x 400 mm	1
20739	Ø 14 x 600 mm	1

No.	specification	
20734	Ø 16 x 400 mm	1
20740	Ø 16 x 600 mm	1
20735	Ø 18 x 400 mm	1
20741	Ø 18 x 600 mm	1



FESTA
FULLY GROUND DRILL

No.	specification	
20210	Ø 7,5, 5 mm	1



DRILL - WOOD

No.	specification	
21440	Ø 4 x 75 mm	1
21441	Ø 5 x 85 mm	1
21442	Ø 6 x 90 mm	1
21443	Ø 7 x 105 mm	1
21444	Ø 8 x 115 mm	1
21445	Ø 9 x 120 mm	1
21446	Ø 10 x 120 mm	1



SAW DRILL

No.	specification	
20460	Ø 6 mm	50



WOOD DRILL SET

No.	specification	
20910	8 pcs Ø 3, 4, 5, 6, 7, 8, 9, 10 mm	10
20905	5 pcs Ø 4, 5, 6, 8, 10 mm	10



FORSTNER BIT SET

No.	specification	
21530	Ø 15, 20, 25, 30, 35 mm Ø 8 mm	20



SAW DRILL SET

No.	specification	
20450	Ø 3, 4, 5, 6, 6.5, 8 mm	20

FLAT WOODEN DRILL SET

No.	specification	
20901	Ø 10, 12, 16, 18, 20, 25 mm	20



GIMLET SET

No.	specification	
20381	Ø 2, 3, 4, 5 mm	20





FESTA

HOLESAW SET

- Ø 19 mm
- Ø 22 mm
- Ø 25,5 mm
- Ø 36 mm
- Ø 44 mm
- Ø 51 mm
- Ø 60 mm
- Ø 67 mm
- Ø 76 mm
- Ø 82 mm
- hex key
- 2x head



12x

No.	specification	
24712	6 tpi	20



FESTA

HOLESAW SET

- Ø 64 mm
- Ø 73 mm
- Ø 89 mm
- Ø 102 mm
- Ø 127 mm
- hex key
- head



8x

No.	specification	
24706	6 tpi	20



FESTA

RING-SHAPED CROWN ADJUSTABLE

Ø 19 - 127 mm



No.	Specification	
24415	Ø 19 - 127 mm	max. hloubka 29 mm

FESTA

HOLESAW



No.	specification	
24715	1' Ø 67 mm	6 tpi
24713	1' Ø 73 mm	6 tpi
24714	1' Ø 102 mm	6 tpi
24720	1' Ø 152 mm	6 tpi



HOLESAW SET



No.	specification	
24721	1' Ø 26, 32, 38, 45, 50, 56, 63 mm	10
24722	2' Ø 26, 32, 38, 45, 50, 56, 63 mm	10

ADJUSTABLE HOLESAW DRILL



No.	specification	
24716	Ø 30 - 120 mm	5



FESTA

CYLINDRICAL RASP

M14



No.	specification	
21807	Ø 30 mm / 60 mm	1

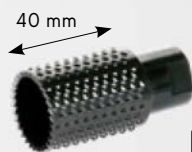

FESTA

BALL RASP

M14



No.	specification	
21808	Ø 30 mm / 105 mm	10

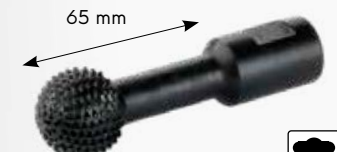



ROTARY RASP SET

5x



No.	specification	1
21541		25



MOUNDED STONE SET

5x



No.	specification	1
21540	Ø 3 mm, 6 mm	12

GRINDING ACCESSORIES

190x



No.	specification	5
24755		

GRINDING ACCESSORIES

150x



No.	specification	10
24756		



ROUTER BIT SET



5x



No.	specification	10
21450	Ø 8 mm	



ROUTER BIT SET



12x

No.	specification	10
21451	Ø 8 mm	



ROUTER BIT SET



24x

No.	specification	1
21452	Ø 8 mm	



ROUTER BIT SET



35x

No.	specification	1
21453	Ø 8 mm	



ROUTER BIT SET



59x

No.	specification	1
21454	Ø 8 mm	

FESTA

MASONRY DRILL

DIN 8039



· two drilling bit



No.	specification	A mm	B mm	
20673	Ø 3 mm	60	30	100
20674	Ø 4 mm	75	40	100
20675	Ø 5 mm	85	50	100
20676	Ø 6 mm	100	60	100
20677	Ø 6 mm	200	160	50
20685	Ø 6 mm	300	260	50
20678	Ø 8 mm	120	75	50
20686	Ø 8 mm	200	155	50

No.	specification	A mm	B mm	
20687	Ø 8 mm	300	255	25
20688	Ø 8 mm	400	340	25
20680	Ø 10 mm	120	70	50
20690	Ø 10 mm	200	150	50
20691	Ø 10 mm	300	250	25
20692	Ø 10 mm	400	340	25
20682	Ø 12 mm	150	100	50
20694	Ø 12 mm	300	250	25

No.	specification	A mm	B mm	
20696	Ø 12 mm	400	340	25
20684	Ø 14 mm	150	90	25
	reduction Ø 10 mm			
20697	Ø 14 mm	300	240	5
	redukce Ø 10 mm			
20698	Ø 14 mm	400	340	15
	reduction Ø 10 mm			

FESTA

MASONRY DRILL SDS+

SDS+

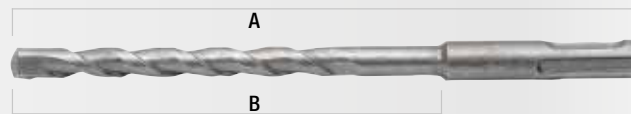

· two drilling bit

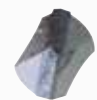

No.	specification	A mm	B mm	
20855	Ø 14 mm	160	75	

No.	specification	A mm	B mm	
				25

No.	specification	A mm	B mm	
				25

FESTA

MASONRY DRILL SDS+

SDS+

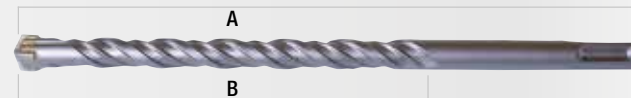

· four drilling bit with increment of feat and lifetime



No.	specification	A mm	B mm	
20748	Ø 6 mm	110	40	50
20749	Ø 6 mm	160	90	50
20750	Ø 6 mm	210	140	50
20751	Ø 6 mm	260	190	50
20861	Ø 6,5 mm	230	160	50
20862	Ø 6,5 mm	300	230	50
20752	Ø 8 mm	110	40	50
20753	Ø 8 mm	160	90	50
20754	Ø 8 mm	210	140	50
20755	Ø 8 mm	260	190	50
20825	Ø 8 mm	350	280	50
20756	Ø 10 mm	160	90	50
20757	Ø 10 mm	210	140	50
20758	Ø 10 mm	260	190	50
20759	Ø 10 mm	350	280	50
20760	Ø 10 mm	450	380	50
20761	Ø 10 mm	600	530	50
20762	Ø 10 mm	1000	930	50
20764	Ø 12 mm	160	80	50
20765	Ø 12 mm	210	130	50
20766	Ø 12 mm	260	180	50
20767	Ø 12 mm	350	270	50

No.	specification	A mm	B mm	
20768	Ø 12 mm	460	380	50
20769	Ø 12 mm	600	520	25
20770	Ø 12 mm	1000	920	25
20771	Ø 14 mm	160	80	25
20772	Ø 14 mm	260	180	25
20773	Ø 14 mm	350	270	25
20774	Ø 14 mm	460	380	25
20775	Ø 14 mm	600	520	25
20776	Ø 14 mm	1000	920	30
20777	Ø 16 mm	160	80	25
20778	Ø 16 mm	210	130	25
20779	Ø 16 mm	260	180	25
20780	Ø 16 mm	350	270	25
20781	Ø 16 mm	460	380	25
20782	Ø 16 mm	600	520	30
20783	Ø 16 mm	1000	920	25
20784	Ø 18 mm	260	180	25
20785	Ø 18 mm	450	370	25
20786	Ø 18 mm	600	520	32
20787	Ø 18 mm	1000	920	20
20788	Ø 20 mm	450	370	20
20789	Ø 20 mm	600	520	20

No.	specification	A mm	B mm	
20790	Ø 20 mm	800	720	25
20791	Ø 20 mm	1000	920	10
20792	Ø 22 mm	450	365	20
20793	Ø 22 mm	600	520	20
20794	Ø 22 mm	800	715	20
20795	Ø 22 mm	1000	920	10
20796	Ø 24 mm	450	365	10
20797	Ø 24 mm	600	520	20
20798	Ø 24 mm	800	715	10
20799	Ø 24 mm	1000	920	10
20870	Ø 26 mm	450	370	10
20871	Ø 26 mm	650	570	20
20872	Ø 26 mm	800	720	10
20873	Ø 26 mm	1000	920	10
20874	Ø 28 mm	450	365	10
20875	Ø 28 mm	600	565	20
20876	Ø 28 mm	800	715	10
20877	Ø 28 mm	1000	915	10
20878	Ø 30 mm	450	365	10
20879	Ø 30 mm	600	565	20
20880	Ø 30 mm	800	715	10
20881	Ø 30 mm	1000	915	10

FESTA

MASONRY DRILL SDS MAX

SDS MAX

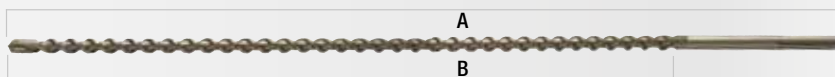

· four drilling bit with increment of feat and lifetime



No.	specification	A mm	B mm	
20508	Ø 16 mm	550	395	5
20510	Ø 18 mm	550	395	5
20520	Ø 18 mm	800	650	5
20511	Ø 20 mm	550	395	5
20521	Ø 20 mm	800	650	5

No.	specification	A mm	B mm	
20512	Ø 22 mm	550	395	5
20522	Ø 22 mm	800	650	5
20513	Ø 24 mm	550	395	5
20523	Ø 24 mm	800	650	5
20514	Ø 28 mm	550	395	5

No.	specification	A mm	B mm	
20524	Ø 28 mm	800	650	5
20515	Ø 30 mm	550	395	5
20525	Ø 30 mm	800	650	5
20516	Ø 40 mm	550	395	2
20526	Ø 40 mm	800	650	1

MASONRY DRILL SET SDS+

5x SDS+



No.	specification		
20890	Ø 5, 6, 8, 10, 12 mm 160 mm		25

MASONRY DRILL SET SDS+

6x SDS+



No.	specification		
20891	Ø 5, 6, 8 mm 110 mm Ø 8, 10, 12 mm 160 mm		25

MASONRY DRILL SET

6x DIN 8039



No.	specification		
20895	Ø 5, 6, 8, 10, 12 mm		25

MASONRY DRILL SET



No.	specification		
20805	5 pcs Ø 4 - 10 mm		10
20820	8 pcs Ø 3 - 10 mm		10



FESTA CHISEL SET

SDS+

4x



No.	specification		
20954	250 mm		1



ADVERTISING STAND

No.	specification		
20999			1

FESTA MASONRY DRILL AND CHISEL SET SDS+

- gad
- chisel
- drill Ø 5-12 mm

17x SDS+



No.	specification		
20952			1

FESTA MASONRY DRILL AND CHISEL SET SDS+

- chisel 250 mm
- chisel hollow 22 x 250 mm
- flat 20 x 250 mm

- Ø 5 x 110 mm
- Ø 6 x 110 mm
- Ø 8 x 160 mm
- Ø 10 x 160 mm
- Ø 12 x 160 mm
- Ø 14 x 210 mm
- Ø 16 x 210 mm
- Ø 18 x 310 mm
- Ø 20 x 450 mm

12x SDS+



No.	specification		
20950			5



FESTA FLAT CHISEL SDS+

SDS+



No.	specification		
20996	250 x 100 mm		1

NEW



FESTA
FLAT CHISEL SDS +

SDS+

No.	Specification	
20997	445 x 130 mm	1

NEW

FESTA
FLAT CHISEL
SDS MAX

SDS MAX



No.	Specification	
20932	450 x 100 mm	1

FESTA
FLAT CHISEL, 15° ANGLE

SDS+

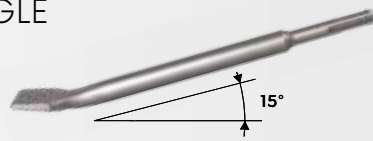

No.	specification	
20936	40 x 250 mm	5

FESTA
FLAT CHISEL

SDS+



No.	specification	
20948	20 x 250 mm	25
20990	20 x 400 mm	25
20949	40 x 250 mm	25
20991	40 x 400 mm	25

FESTA
CHISEL

SDS MAX



No.	specification	
20940	25 x 280 mm	5
20941	40 x 280 mm	5
20942	75 x 280 mm	5
20943	25 x 400 mm	5
20944	40 x 400 mm	5
20945	25 x 600 mm	5
20946	50 x 600 mm	5

FESTA
HAMMER CHISEL

SDS+



No.	specification	
20947	250 mm	25
20992	400 mm	25

FESTA
HAMMER CHISEL

SDS MAX



No.	specification	
20937	∅ 18 x 280 mm	5
20938	∅ 18 x 400 mm	5
20939	∅ 18 x 600 mm	2

FESTA
CHISEL

SDS+



No.	specification	
20956	22 x 250 mm	25

FESTA
MASONRY HOLESAW WITH TC TOOTH
SDS+

clamping clip for drill bits 24730, 24731 a 24732

SDS+



No.	specification	
24719	∅ 67 mm	1
24717	∅ 73 mm	1
24723	∅ 80 mm	1
24718	∅ 100 mm	1
24757	∅ 115 mm	1
24758	∅ 125 mm	1
24759	∅ 150 mm	1

FESTA
CLAMPING CLIP FOR DRILL BITS

SDS MAX

No.	specification	
24730	180 mm	1



FESTA
CLAMPING CLIP FOR DRILL BITS

SDS+

No.	specification	
24731	300 mm	1
24732		1





FESTA

HOLESAW SET FOR TILES



6x



No.	specification	
24745	Ø 33, 53, 67, 73 mm driving peg, drill	1



FESTA

HOLESAW SET



8x

No.	specification	
24747	Ø 33, 53, 67, 73, 83 mm drivig peg, drill, file	1

FESTA

HOLESAW



No.	specification	
24735	Ø 33 mm	1
24736	Ø 43 mm	1
24737	Ø 53 mm	1
24738	Ø 67 mm	1
24739	Ø 73 mm	1
24740	Ø 83 mm	1
24741	Ø 103 mm	1



FESTA

HOLESAW SET FOR TILES

3x



No.	specification	
24746	Ø 103 mm + driving peg, drill	1



FESTA

DRILL FOR HOLESAW



No.	specification	
24749		50



FESTA

DRIVING PEG FOR HOLESAW



No.	specification	
24748	Ø 33 - 83 mm	10
24743	Ø 33 - 103 mm	10



FESTA

CARBIDE HOLESAW

· for glass and ceramics drilling
· cooling required



No.	specification	
24770	Ø 4 mm	1
24771	Ø 6 mm	1
24772	Ø 8 mm	1
24773	Ø 10 mm	1
24774	Ø 12 mm	1



HOLESAW WITH COVER

No.	specification	
24726	Ø 20-95mm	1



HOLESAW

No.	specification	
24725	Ø 20-95mm	10



FESTA

FILE FOR TILES, ROUND



No.	specification	
22200	160 mm	20



FESTA

FILE FOR TILES, FLAT

· for grinding bricks before inserting a wall anchor



No.	specification	
22201	200 mm double asperity	20





DIAMOND HOLESAW SET

- Ø 6 mm
- Ø 8 mm
- Ø 10 mm
- Ø 12 mm
- Ø 20 mm
- Ø 28 mm
- Ø 35 mm
- Ø 45 mm
- Ø 55 mm
- Ø 68 mm

cutting / grinding disc Ø 125 mm x 2,0 mm Ø 22,2 mm
 cutting disc Ø 125 mm x 1,2 mm Ø 22,2 mm
 diamond grinding cone Ø 0 - 50 mm
 diamond sanding sponge block 90 x 55 mm P60

13x M14

- ceramic tiles and pavement
- marble
- granite

· no need to cool with water



No.	specification	
24652		1



DIAMOND HOLESAW

M14

- ceramic tiles and pavement
- marble
- granite

· no need to cool with water



No.	specification	
24620	Ø 6 mm M14	1
24621	Ø 8 mm M14	1
24622	Ø 10 mm M14	1
24623	Ø 12 mm M14	1
24624	Ø 14 mm M14	1
24627	Ø 20 mm M14	1
24630	Ø 28 mm M14	1
24633	Ø 35 mm M14	1
24636	Ø 45 mm M14	1
24638	Ø 55 mm M14	1
24640	Ø 68 mm M14	1
24642	NEW Ø 72 mm M14	1
24643	Ø 75 mm M14	1



DIAMOND HOLESAW SET

- Ø 6 mm
- Ø 8 mm
- Ø 10 mm
- Ø 20 mm
- Ø 35 mm
- Ø 45 mm
- Ø 55 mm
- Ø 68 mm

8x M14

- ceramic tiles and pavement
- marble
- granite

· no need to cool with water



No.	specification	
24651		1



DIAMOND GRINDING DRUM

M14

- ceramic tiles and pavement
- marble
- granite

· no need to cool with water



No.	specification	
24795	Ø 20 / 50 mm	1
24797	Ø 6 / 50 mm	1
24799	Ø 10 / 50 mm	1



DIAMOND GRINDING CONE

M14

- ceramic tiles and pavement
- marble
- granite

· no need to cool with water



No.	specification	
24775	NEW Ø 2 - 35 mm	1
24777	Ø 2 - 75 mm	1
24778	Ø 2 - 50 mm	1



1 Ø 2 mm - Ø 75 mm



DIAMOND GRINDING CONE

M14

- ceramic tiles
- marble
- granite

no need to cool with water



No.	Specification	Icon
24779	Ø 20 - 48 mm	1



DIAMOND GRINDING DRUM

M14

- ceramic tiles and pavement
- marble
- granite

no need to cool with water



No.	Specification	Icon
24663	Ø 50 mm	1



DIAMOND HOLESAW

M14

- ceramic tiles
- marble
- granite

no need to cool with water



No.	specification	úchyt	Icon	No.	specification	úchyt	Icon
24760	Ø 6 mm	M14	1	24766	Ø 35 mm	M14	1
24761	Ø 8 mm	M14	1	24776	Ø 40 mm	M14	1
24762	Ø 10 mm	M14	1	24767	Ø 45 mm	M14	1
24763	Ø 12 mm	M14	1	24791	Ø 50 mm	M14	1
24764	Ø 14 mm	M14	1	24768	Ø 53 mm	M14	1
24670	Ø 16 mm	M14	1	24792	Ø 60 mm	M14	1
24671	Ø 18 mm	M14	1	24793	Ø 65 mm	M14	1
24790	Ø 20 mm	M14	1	24769	Ø 68 mm	M14	1
24672	Ø 22 mm	M14	1	24794	Ø 75 mm	M14	1
24673	Ø 25 mm	M14	1	24796	Ø 83 mm	M14	1
24765	Ø 28 mm	M14	1	24677	Ø102 mm	M14	1
24674	Ø 30 mm	M14	1	24676	Ø 110 mm	M14	1
24675	Ø 32 mm	M14	1	24678	Ø125 mm	M14	1



DIAMOND GRINDING DISC

M14

- ceramic tiles and pavement
- marble
- granite

no need to cool with water



No.	Specification	Icon
24661	Ø 50 mm	1



DIAMOND HOLESAW - SET

7x M14

- ceramic tiles
- marble
- granite

no need to cool with water



No.	Specification	Icon
24650		1



DIAMOND HOLESAW

- ceramic tiles
- marble
- granite



No.	specification	Icon
24700	Ø 6 mm	1
24701	Ø 8 mm	1
24702	Ø 10 mm	1
24703	Ø 12 mm	1
24704	Ø 14 mm	1
24705	Ø 20 mm	1



FESTA

COOLING WAX FOR DIAMOND HOLESAW



No.	specification	
24710	30 ml	1

FESTA

DIAMOND HOLESAW - SET



6x

- ceramic tiles
- marble
- granite

No.	specification	
24798	Ø 6, 8, 10, 12, 14, 20 mm	1



FESTA

DIAMOND DISC CUTTING AND GRINDING

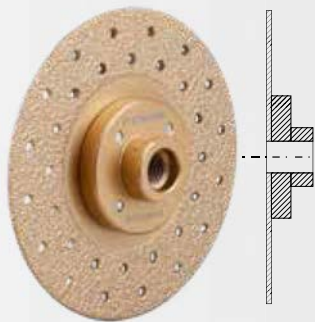

M14

- ceramic tiles
- marble
- granite

- no need to cool with water

No.	Specification	
24655	Ø 115 mm M14	1

FESTA

DIAMOND DISC GRINDING

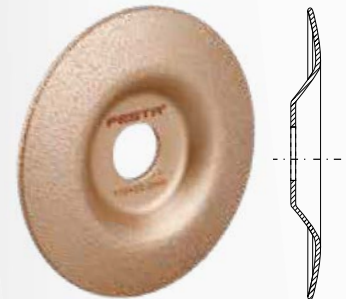

- ceramic tiles
- marble
- granite

- no need to cool with water

No.	Specification	
24658	Ø 115 mm Ø 22,2 mm	1

FESTA

DRILL FOR GLASS AND CERAMICS

TiN 1/4"

- ceramic tiles
- glass
- marble
- granite

No.	specification	
24780	Ø 4 mm	40
24781	Ø 5 mm	40
24782	Ø 6 mm	40
24783	Ø 8 mm	40
24784	Ø 10 mm	40
24785	Ø 12 mm	40
24786	Ø 14 mm	1
24787	Ø 16 mm	1
24788	Ø 18 mm	1
24789	Ø 20 mm	1



FESTA

DRILL FOR GLASS AND CERAMICS, SET

- Ø 4 mm
- Ø 5 mm
- Ø 6 mm
- Ø 8 mm
- Ø 10 mm

5x

- ceramic tiles and pavement
- marble
- granite

- no need to cool with water

No.	specification	
24734		1





DIAMOND CUTTING / GRINDING DISC

- ceramic tiles and pavement
- marble
- granite

no need to cool with water



No.	specifications		
21230	Ø 115 mm x 1,8 mm	Ø 22,2 mm	1
21231	Ø 125 mm x 2,0 mm	Ø 22,2 mm	1



DIAMOND CUTTING DISC TURBO EXTREME

- reinforced concrete
- ceramic tiles and pavement
- marble
- granite

no need to cool with water

No.	specifications		
21205	Ø 125 mm x 2,0 mm	Ø 22,2 mm	1
21209	Ø 230 mm x 2,6 mm	Ø 22,2 mm	1



DIAMOND CUTTING DISC

- ceramic tiles and pavement
- marble
- granite

no need to cool with water

No.	specifications		
21234 NEW	Ø 115 mm x 1,2 x 8 mm	Ø 22,2 mm	1
21235	Ø 125 mm x 1,2 x 8 mm	Ø 22,2 mm	1
21238 NEW	Ø 200 mm x 1,6 x 11 mm	Ø 25,4 mm	1



DIAMOND DISC FESTA INDUSTRY

- ceramic tiles and pavement
- marble
- granite

no need to cool with water

No.	specification		
21200	Ø 115 mm 1,4 mm Ø 22,2 mm		1
21201	Ø 125 mm 1,4 mm Ø 22,2 mm		1
21204	Ø 200 mm 1,8 mm Ø 25,4 mm		1
21203	Ø 230 mm 1,8 mm Ø 22,2 mm		1



FESTA

DIAMOND DISC SEGMENTED



No.	specification	
21311	Ø 115 mm Ø 22,2 mm	1
21312	Ø 125 mm Ø 22,2 mm	1
21315	Ø 150 mm Ø 22,2 mm	1
21318	Ø 180 mm Ø 22,2 mm	1
21323	Ø 230 mm Ø 22,2 mm	1
21324	Ø 300 mm Ø 25,4 mm	1
21327	Ø 350 mm Ø 25,4 mm	1
21326	Ø 400 mm Ø 25,4 mm	1



FESTA

DIAMOND DISC TURBO



No.	specification	
21411	Ø 115 mm Ø 22,2 mm	1
21412	Ø 125 mm Ø 22,2 mm	1
21415	Ø 150 mm Ø 22,2 mm	1
21418	Ø 180 mm Ø 22,2 mm	1
21423	Ø 230 mm Ø 22,2 mm	1
21424	Ø 300 mm Ø 25,4 mm	1



FESTA

DIAMOND DISC FULL



No.	specification	
21210	Ø 110 mm Ø 22,2 mm	1
21211	Ø 115 mm Ø 22,2 mm	1
21212	Ø 125 mm Ø 22,2 mm	1
21215	Ø 150 mm Ø 22,2 mm	1
21218	Ø 180 mm Ø 22,2 mm	1
21219	Ø 180 mm Ø 25,4 mm	1
21220	Ø 200 mm Ø 25,4 mm	1
21223	Ø 230 mm Ø 22,2 mm	1
21224	Ø 300 mm Ø 25,4 mm	1



FESTA
INDUSTRY

UNIVERSAL DIAMOND CUTTING DISC



No.	specification	
21301	Ø 125 mm Ø 22,2 mm 1,5 mm	1
21303	Ø 230 mm Ø 22,2 mm 1,8 mm	1



FESTA

DIAMOND DISCS SEGMENTED, DOUBLE



No.	specification	
21195	Ø 125 x 22,2 mm	1



6 mm



DIAMOND DISC FULL



No.	specification	
21010	Ø 110 mm Ø 22,2 mm	1
21011	Ø 115 mm Ø 22,2 mm	1
21012	Ø 125 mm Ø 22,2 mm	1
21015	Ø 150 mm Ø 22,2 mm	1
21018	Ø 180 mm Ø 22,2 mm	1
21023	Ø 230 mm Ø 22,2 mm	1



DIAMOND DISC SEGMENTED



No.	specification	
21110	Ø 110 mm Ø 22,2 mm	1
21111	Ø 115 mm Ø 22,2 mm	1
21112	Ø 125 mm Ø 22,2 mm	1
21115	Ø 150 mm Ø 22,2 mm	1
21118	Ø 180 mm Ø 22,2 mm	1
21123	Ø 230 mm Ø 22,2 mm	1



DIAMOND DISC TURBO



No.	specification	
21130	Ø 110 mm Ø 22,2 mm	1
21135	Ø 115 mm Ø 22,2 mm	1
21140	Ø 125 mm Ø 22,2 mm	1
21150	Ø 150 mm Ø 22,2 mm	1
21180	Ø 180 mm Ø 22,2 mm	1
21190	Ø 230 mm Ø 22,2 mm	1



FESTA

DIAMOND GRINDING DISC



No.	specifications		
21435	Ø 115 mm	Ø 22,2 mm	1
21436	Ø 125 mm	Ø 22,2 mm	1
21437	Ø 150 mm	Ø 22,2 mm	1



FESTA

DIAMOND DISC GRINDING DOUBLE BRED



No.	specification		
21430	Ø 115 mm	Ø 22,2 mm	1
21431	Ø 125 mm	Ø 22,2 mm	1
21432	Ø 150 mm	Ø 22,2 mm	1



FESTA

DIAMOND DISC GRINDING TURBO



No.	specification		
21425	Ø 100 mm	Ø 22,2 mm	1
21426	Ø 115 mm	Ø 22,2 mm	1
21427	Ø 125 mm	Ø 22,2 mm	1
21428	Ø 150 mm	Ø 22,2 mm	1



FESTA
INDUSTRY

CUTTING DISC FOR METAL



No.	specification		
22258	Ø 115 mm	Ø 22,2 mm x 0,8 mm	25
22260	Ø 115 mm	Ø 22,2 mm x 1 mm	25
22263	Ø 115 mm	Ø 22,2 mm x 1,6 mm	25
22264	Ø 115 mm	Ø 22,2 mm x 2 mm	25
22259	Ø 125 mm	Ø 22,2 mm x 0,8 mm	25
22266	Ø 125 mm	Ø 22,2 mm x 1 mm	25
22269	Ø 125 mm	Ø 22,2 mm x 1,6 mm	25
22270	Ø 125 mm	Ø 22,2 mm x 2 mm	25
22273	Ø 150 mm	Ø 22,2 mm x 1,6 mm	25
22274	Ø 150 mm	Ø 22,2 mm x 2 mm	25
22275	Ø 150 mm	Ø 22,2 mm x 2,5 mm	25
22277	Ø 180 mm	Ø 22,2 mm x 2 mm	25
22280	Ø 230 mm	Ø 22,2 mm x 2 mm	25
22281	Ø 230 mm	Ø 22,2 mm x 2,5 mm	25

FESTA
INDUSTRY

CUTTING DISC FOR ALUMINIUM



No.	specification		
22285	Ø 115 mm	Ø 22,2 mm x 1 mm	1
22286	Ø 125 mm	Ø 22,2 mm x 1 mm	1

FESTA
INDUSTRY

CUTTING DISC FOR STONE



No.	specification		
22294	Ø 230 mm	Ø 22,2 mm x 3 mm	1

FESTA

CUTTING DISC FOR METAL



No.	specification	
22211	Ø 115 mm Ø 22,2 mm x 1 mm	INOX 50
22212	Ø 115 mm Ø 22,2 mm x 1,2 mm	INOX 50
22225	Ø 125 mm Ø 22,2 mm x 1 mm	INOX 50
22217	Ø 125 mm Ø 22,2 mm x 1,2 mm	INOX 50

FESTA

CUTTING DISC FOR METAL

10x



No.	specification	
22228	Ø 115 mm Ø 22,2 mm x 1 mm	INOX 1
22229	Ø 125 mm Ø 22,2 mm x 1,2 mm	INOX 1

FESTA

CUTTING DISC FOR METAL



No.	specification	
22251	Ø 115 mm Ø 22,2 mm x 1,6 mm	50
22215	Ø 115 mm Ø 22,2 mm x 2 mm	50
22216	Ø 115 mm Ø 22,2 mm x 2,5 mm	50
22252	Ø 125 mm Ø 22,2 mm x 1,6 mm	25
22218	Ø 125 mm Ø 22,2 mm x 2,5 mm	25
22219	Ø 150 mm Ø 22,2 mm x 1,2 mm	25
22253	Ø 150 mm Ø 22,2 mm x 1,6 mm	50
22220	Ø 150 mm Ø 22,2 mm x 2,5 mm	50
22254	Ø 180 mm Ø 22,2 mm x 1,6 mm	50
22222	Ø 180 mm Ø 22,2 mm x 2,5 mm	25
22255	Ø 230 mm Ø 22,2 mm x 1,6 mm	25
22224	Ø 230 mm Ø 22,2 mm x 2,5 mm	25

FESTA

GRINDING DISC FOR METAL



No.	specification	
22240	Ø 115 mm Ø 22,2 mm x 6,4 mm	25
22242	Ø 125 mm Ø 22,2 mm x 6,4 mm	25
22244	Ø 150 mm Ø 22,2 mm x 6,4 mm	25
22246	Ø 180 mm Ø 22,2 mm x 6,4 mm	25
22248	Ø 230 mm Ø 22,2 mm x 6,4 mm	25

FESTA

CUTTING DISC FOR METAL DIAMOND



No.	specification	
21306	Ø 125 mm Ø 22,2 mm 1,3 mm	1
21308	Ø 230 mm Ø 22,2 mm 1,8 mm	1

FESTA

CUTTING DISC FOR STONE



No.	specification	
22230	Ø 115 mm Ø 22,2 mm x 2,5 mm	50
22232	Ø 125 mm Ø 22,2 mm x 2,5 mm	50
22234	Ø 150 mm Ø 22,2 mm x 2,5 mm	25
22236	Ø 180 mm Ø 22,2 mm x 2,5 mm	25
22238	Ø 230 mm Ø 22,2 mm x 2,5 mm	25

FESTA

UNIVERSAL CUTTING DISC CARBIDE



No.	specification	
21192	Ø 125 mm Ø 22,2 mm	1
21194	Ø 230 mm Ø 22,2 mm	1



FESTA
RASP WHEEL

No.	specifications			
21806	Ø 125 mm	Ø 22,2 mm		1



FESTA
RASP WHEEL
MEDIUM
COARSE

No.	specification			
21802	Ø 125 mm	Ø 22,2 mm	3 mm	10



FESTA
RASP WHEEL
COARSE

No.	specification			
21801	Ø 125 mm	Ø 22,2 mm	3 mm	10



FESTA
SAW RASP DISC

No.	Specification			
21803	Ø 125 mm	Ø 22,2 mm		1

NEW



FESTA
SAW RASP DISC

No.	Specification			
21805	Ø 125 mm	Ø 22,2 mm		1



FESTA
DISC
FOR WOOD
WITH HOLES

· grinding disc suitable for grinding wood

No.	specification			
21800	Ø 125 mm	Ø 22,2 mm		1



FESTA
CYLINDRICAL RASP

M14

No.	specifications			
21807	Ø 30 mm / 60 mm			1



FESTA
WOOD
CARVING DISC

No.	Specification			
21804	Ø 125 mm	Ø 22,2 mm	14T	1



FESTA
BALL RASP

M14

No.	specifications			
21808	Ø 30 mm / 105 mm			10

NEW



CUTTING DISC FOR WOOD



No.	Specifications	
21809	Ø 125 mm x 4T Ø 22,2 mm	1

NEW



FESTA

MULTI-PLATE DOUBLE-SIDED DISC



INOX

No.	specifications	hrubost	
21760	Ø 125 mm Ø 22,2 mm	P40	10
21761	Ø 125 mm Ø 22,2 mm	P60	10
21762	Ø 125 mm Ø 22,2 mm	P80	10
21763	Ø 125 mm Ø 22,2 mm	P100	10
21764	Ø 125 mm Ø 22,2 mm	P120	10

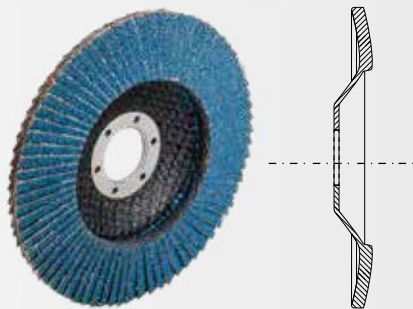

FESTA

MULTI-PLATE DISC

grinding disc suitable for grinding stainless steel



INOX

No.	specification	asperity	
22140	Ø 115 mm Ø 22,2 mm	P40	5
22141	Ø 115 mm Ø 22,2 mm	P60	5
22142	Ø 115 mm Ø 22,2 mm	P80	5
22143	Ø 115 mm Ø 22,2 mm	P100	5
22145	Ø 125 mm Ø 22,2 mm	P40	5
22146	Ø 125 mm Ø 22,2 mm	P60	5
22147	Ø 125 mm Ø 22,2 mm	P80	5
22148	Ø 125 mm Ø 22,2 mm	P100	5
22150	Ø 150 mm Ø 22,2 mm	P40	5
22151	Ø 150 mm Ø 22,2 mm	P60	5
22155	Ø 150 mm Ø 22,2 mm	P80	5
22156	Ø 150 mm Ø 22,2 mm	P100	5

NEW



FESTA INDUSTRY

DIAMOND DISC MULTI-PLATE



- ceramic tiles and pavement
- marble
- granite



- no need to cool with water

No.	specifications			
24647	Ø 115 mm Ø 22,2 mm	● P60		1
24648	Ø 115 mm Ø 22,2 mm	● P120		1
24649	Ø 115 mm Ø 22,2 mm	● P200		1

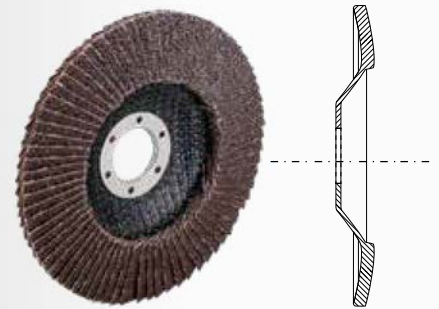

MULTI-PLATE DISC



No.	specification	asperity	
21780	Ø 115 mm Ø 22,2 mm	P40	10
21781	Ø 115 mm Ø 22,2 mm	P60	10
21782	Ø 115 mm Ø 22,2 m	P80	10
21783	Ø 115 mm Ø 22,2 mm	P100	10
21784	Ø 115 mm Ø 22,2 mm	P120	10
21786	Ø 125 mm Ø 22,2 mm	P40	10
21787	Ø 125 mm Ø 22,2 mm	P60	10
21788	Ø 125 mm Ø 22,2 mm	P80	10
21789	Ø 125 mm Ø 22,2 mm	P100	10
21790	Ø 125 mm Ø 22,2 mm	P120	10
21792	Ø 150 mm Ø 22,2 mm	P40	10
21793	Ø 150 mm Ø 22,2 mm	P60	10
21794	Ø 150 mm Ø 22,2 mm	P80	10
21795	Ø 150 mm Ø 22,2 mm	P100	10
21796	Ø 150 mm Ø 22,2 mm	P120	10

BRUSH NYLON WITH PAD



No.	specification	
21798	Ø 125 mm Ø 22,2 mm	1





FESTA



FESTA
BEVEL BRUSH, BRASS COATED

· brass coated

M14 

No.	specification	wire	
21900	Ø 100 mm M14	s 0,3	60
21902	Ø 125 mm M14	s 0,3	42



FESTA
BEVEL BRUSH, BRASS COATED

· brass coated

M14 

No.	specification	wire	
22001	Ø 100 mm M14	s 0,3	60
21901	Ø 125 mm M14	s 0,3	42



FESTA
BEVEL BRUSH, BRASS

· brass

M14 

No.	specification	wire	
21920	Ø 100 mm M14	s 0,3	60



FESTA
CUP BRUSH, BRASS COATED

· brass coated

M14 

No.	specification	wire	
21903	Ø 65 mm M14	s 0,3	60
22002	Ø 75 mm M14	s 0,3	80
21904	Ø 85 mm M14	s 0,3	60
22003	Ø 100 mm M14	s 0,3	36
21905	Ø 125 mm M14	s 0,3	24
21906	Ø 150 mm M14	s 0,3	12



FESTA
CUP BRUSH, BRASS

· brass

M14 

No.	specification	wire	
21925	Ø 75 mm M14	0,3 mm	80
21926	Ø 100 mm M14	0,3 mm	36



FESTA
RADIAL BRUSH, BRASS COATED

· brass coated

· reduction rings

M14 

No.	specification	wire	
22007	Ø 100 mm Ø 20 mm	s 0,3	60
22008	Ø 125 mm Ø 20 mm	s 0,3	42
22009	Ø 150 mm Ø 32,2 mm	s 0,3	32
22010	Ø 175 mm Ø 32,2 mm	s 0,3	20
22011	Ø 200 mm Ø 32,2 mm	s 0,3	20



FESTA
CUP BRUSH, KNOTTED - INOX

· hardened

INOX M14 

No.	specification	wire	
22037	Ø 65 mm M14	s 0,5	60
22038	Ø 80 mm M14	s 0,5	24



FESTA
CUP BRUSH, KNOTTED

· hardened

M14 

No.	specification	wire	
22004	Ø 65 mm M14	s 0,3	60
22005	Ø 75 mm M14	s 0,3	24
22006	Ø 100 mm M14	s 0,3	24
21907	Ø 125 mm M14	s 0,3	24
21908	Ø 150 mm M14	s 0,3	12



FESTA
RADIAL BRUSH, KNOTTED

· hardened

M14 

No.	specification	wire	počet copů	
21911	Ø 100 mm M14	s 0,5	30	60
21912	Ø 115 mm M14	s 0,5	32	42
21913	Ø 125 mm M14	s 0,5	36	42
21914	Ø 150 mm M14	s 0,5	40	32



FESTA

RADIAL BRUSH, KNOTTED

· hardened

M14

No.	specification	wire	
22012	Ø 100 mm M14	s 0,5	60
22013	Ø 115 mm M14	s 0,5	42
22014	Ø 125 mm M14	s 0,5	42
22015	Ø 150 mm M14	s 0,5	32
22016	Ø 178 mm M14	s 0,5	20



FESTA

RADIAL BRUSH, KNOTTED

· hardened

INOX M14

No.	specification	wire	
22039	Ø 100 mm M14	s 0,5	60
22040	Ø 125 mm M14	s 0,5	42



FESTA

BEVEL BRUSH, KNOTTED

· hardened

M14

No.	specification	wire	
22017	Ø 100 mm M14	s 0,5	60
21909	Ø 115 mm M14	s 0,5	42
21910	Ø 125 mm M14	s 0,5	42



FESTA

BEVEL BRUSH, KNOTTED

· hardened

No.	specification	wire	
22023	Ø 75 mm	s 0,5	10



FESTA

CUP BRUSH KNOTTED, SHANK

· hardened

No.	specification	wire	
22024	Ø 75 mm	s 0,5	12



FESTA

BEVEL BRUSH KNOTTED, SHANK

· hardened

No.	specification	wire	
22025	Ø 75 mm	s 0,5	12

NEW



FESTA

BEVEL BRUSH KNOTTED

No.	Specifications	
21950	Ø 200 mm 25,4 mm	1



FESTA

CUP BRUSH BRASS COATED

· brass coated

No.	specification	wire	
22030	Ø 65 mm	s 0,3	12
22031	Ø 75 mm	s 0,3	12



FESTA

RADIAL BRUSH BRASS COATED

· brass coated

No.	specification	wire	
22026	Ø 50 mm	s 0,3	15
22027	Ø 63 mm	s 0,3	15
22028	Ø 75 mm	s 0,3	10
22029	Ø 100 mm	s 0,3	15



FESTA

END BRUSH, SHANK

No.	specification	wire	
22058	Ø 12 mm	s 0,3	25
22059	Ø 25 mm	s 0,3	25



FESTA

END BRUSH, SHANK

· brass coated

No.	specification	wire	
22018	Ø 12 mm	s 0,3	15
22019	Ø 17 mm	s 0,3	15
22020	Ø 25 mm	s 0,3	25



FESTA

END BRUSH, KNOTTED

· hardened

No.	specification	wire	
22021	Ø 19 mm	s 0,5	30
22022	Ø 22 mm	s 0,5	25



FESTA

CUP BRUSH, NYLON

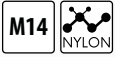

No.	specification	wire	
21940	Ø 75 mm M14	1,2 mm	1
21941	Ø 100 mm M14	1,2 mm	1



FESTA

RADIAL BRUSH, NYLON



No.	specification	wire	
21930	Ø 125 mm M14	1,2 mm	10
21931	Ø 150 mm M14	1,2 mm	15

Ø 6 mm



FESTA

FLAPPER BRUSH, NYLON, SHANK



No.	specification	wire	
22032	Ø 100 mm	1,2 mm	12

Ø 6 mm



FESTA

RADIAL BRUSH, NYLON, STALK



No.	specification	wire	
21935	Ø 50 mm	1,2 mm	1
21936	Ø 75 mm	1,2 mm	1
21937	Ø 100 mm	1,2 mm	1



Ø 6 mm

NYLON BRUSH DISC, SHANK



No.	specification	
22088	Ø 65 mm	9
22090	Ø 100 mm	5



BRUSH NYLON WITH PAD



No.	specification	
22083	Ø 115 mm Ø 22,2 mm	10
22084	Ø 125 mm Ø 22,2 mm	10
22085	Ø 150 mm Ø 22,2 mm	10



NYLON BRUSH DISC



No.	specification	
22095	Ø 178 mm	1

NEW

FESTA

DIAMOND GRINDING DISC WITH VELCRO

- ceramic tiles
- glass
- marble
- granite



• backing pad 22043

No.	specifications	asperity	
24665	Ø 100 mm	● P60	10
24666	Ø 100 mm	● P120	10
24667	Ø 100 mm	● P200	10



FESTA

DIAMOND POLISHING DISC Ø 100 MM, WITH VELCRO

- ceramic tiles
- glass
- marble
- granite



• backing pad 22043

No.	asperity	
22701	50	1
22702	100	1
22703	200	1
22704	400	1
22705	800	1
22706	1500	1
22707	3000	1



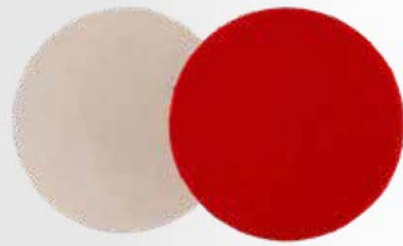

POLISHING PAD



No.	specification	specification	
22065	Ø 125 mm	bind with velcro	20
22066	Ø 150 mm	bind with velcro	20

POLISHING FELT WITH VELCRO



No.	specification	
22070	Ø 115 mm	20
22071	Ø 125 mm	20
22072	Ø 150 mm	20

FESTA

BACKING PAD, BIND WITH VELCRO

- M14 | Ø 8 mm
- EVA 10 mm

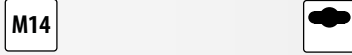

No.	specification	
22062	Ø 115 mm	25
22063	Ø 125 mm	25
22064	Ø 150 mm	10

FESTA

BACKING PAD FOR FIBER DISC

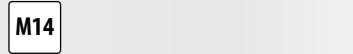

No.	specification	
22073	Ø 125 mm, M14	1
22074	Ø 150 mm, M14	1



FESTA

BACKING PAD FOR DIAMOND POLISHING DISCS

- for angle grinding machine
- for 24665-24667, 22701-22707

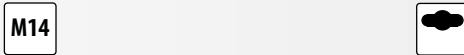

No.	specification	
22043	Ø 100 mm	1



BACKING PAD

- for angle grinding machine

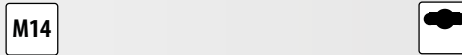

No.	specification	
22044	Ø 125 mm	M14 bind with velcro 15
22060	Ø 150 mm	M14 bind with velcro 6



ADAPTER



No.	specification	
22087		1



BACKING PAD

No.	specification	
22061	Ø 125 mm	bind with velcro 6



BACKING PAD

No.	specification	
22041	Ø 125 mm	bind with screw 11
22042	Ø 125 mm	bind with velcro 11



NYLON BRUSH DISK



No.	specification	
22091	Ø 50 mm	P240 1
22092	Ø 75 mm	P240 1
22093	Ø 100 mm	P240 1

FESTA

FIBER DISC - Ø 125 MM



No.	asperity	
22160	P40	1
22161	P60	1
22162	P80	1
22163	P100	1
22164	P120	1



FESTA

FIBER DISC - Ø 150 MM



No.	asperity	
22167	P80	1



FESTA

SANDING PAPER Ø 125 MM, WITH VELCRO

3x

No.	asperity	
22045	P40	1
22046	P60	1
22047	P80	1
22048	P100	1
22049	P120	1
22050	P150	1
22051	P180	1
22052	P220	1



FESTA

SANDING PAPER Ø 150 MM, WITH VELCRO

3x

No.	asperity	
22053	P40	1
22054	P60	1
22055	P80	1
22056	P100	1
22057	P120	1

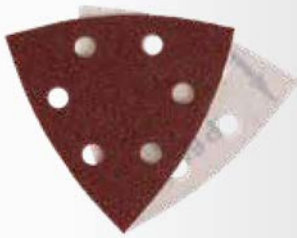

FESTA

VIBRATORY CUT
94 X 94 X 94 MM

No.	asperity	
21831	P60	1
21832	P80	1
21834	P120	1



SANDING PAPER, WITH
VELCRO 125 MM

3x

No.	asperity	
22096	P40	20
22097	P60	20
22098	P80	20
22099	P120	20



FESTA

ENDLESS SANDING BELT
75 X 533 MM

3x

No.	asperity	
21810	P40	20
21811	P60	20
21812	P80	20
21813	P100	20
21814	P120	20



SANDING PAPER 93 X 230 MM

5x

No.	asperity	number of holes	
21740	P40	8	20
21741	P60	8	20
21742	P80	8	20
21743	P100	8	20
21744	P120	8	20



SANDING PAPER 115 X 280 MM

5x

No.	asperity	number of holes	
21750	P40	10	20
21751	P60	10	20
21752	P80	10	20
21753	P100	10	20
21754	P120	10	20



SANDING CLOTH 230 X 280 MM

10x

No.	asperity	
21732	P40	1
21734	P60	1
21735	P80	1
21736	P100	1
21737	P120	1



SANDING PAPER WATERPROOF
230 X 280 MM

10x

No.	asperity	
21701	P60	1
21702	P80	1
21703	P100	1
21704	P120	1
21705	P150	1
21706	P180	1
21709	P240	1



SANDING PAPER 230 X 280 MM

10x

No.	asperity	
21715	P40	1
21716	P60	1
21717	P80	1
21718	P100	1
21719	P120	1
21720	P150	1
21721	P180	1
21724	P240	1

NEW



FESTA

HOLDER FOR SANDING PAPER

· Ø 150 mm



No.	Specifications	
22119		1

FESTA

HOLDER FOR SANDING PAPER

· quick grip



No.	specification	
22067	170 x 70 mm	10

HOLDER FOR SANDING PAPER



No.	specification	
22075	210 x 105 mm	100
22076	160 x 85 mm	100

HOLDER FOR SANDING PAPER



No.	specification	
22077	125 x 68 mm	10

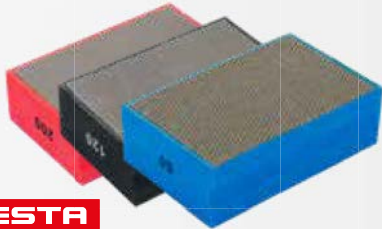

FESTA

DIAMOND SANDING SPONGE BLOCK

· 90 x 55 x 25 mm

- ceramic tiles
- glass
- marble
- granite



No.	asperity	
22115	P60	10
22116	P120	10
22117	P200	10

GRINDING LAMELL DISC WITH SHANK

No.	asperity	specification	
21850	P40		1
21851	P60		1
21852	P80	20 x 20, Ø 6 mm	1
21853	P100		1
21854	P120		1
21855	P40		1
21856	P60		1
21857	P80	30x30, Ø 6mm	1
21858	P100		1
21859	P120		1
21860	P40		1
21861	P60		1
21862	P80	60x30, Ø 6mm	1
21863	P100		1
21864	P120		1



FESTA

SANDING SPONGE BLOCK 100 X 70 X 28 MM - BEVELED



No.	asperity	
22106	P 60	10
22107	P 80	10
22108	P 100	10
22109	P 120	10



FESTA

SANDING SPONGE BLOCK 100 X 70 X 25 MM



No.	asperity	
22100	P60	20
22101	P80	20
22102	P100	20
22103	P120	20
22104	P180	20
22105	P220	20



FESTA

SANDING SPONGE BLOCK 120 X 95 X 10 MM



No.	asperity	
22110	P80	20
22111	P120	20
22112	P180	20
22113	P220	20

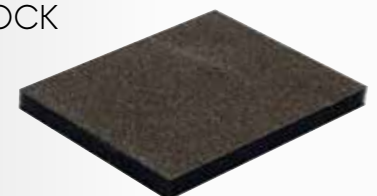

FESTA



No.	specification	number of teeth	
Ø 115 mm			
22300	Ø 115 x 22 mm	40	1
Ø 125 mm			
22301	Ø 125 x 22 mm	40	1
Ø 140 mm			
22302	Ø 140 x 20 mm	24	1
22303	Ø 140 x 20 mm	30	1
Ø 150 mm			
22305	Ø 150 x 20 mm	24	1
Ø 160 mm			
22307	Ø 160 x 20 mm	18	1
22309	Ø 160 x 20 mm	24	1
22310	Ø 160 x 20 mm	30	1
22311	Ø 160 x 20 mm	36	1
22312	Ø 160 x 20 mm	48	1
22313	Ø 160 x 20 mm	60	1
Ø 165 mm			
22314	Ø 165 x 20 mm	24	1
Ø 180 mm			
22315	Ø 180 x 30 mm	24	1
22317	Ø 180 x 30 mm	50	1
22318	Ø 180 x 20 mm	50	1
Ø 185 mm			
22316	Ø 185 x 20 mm	24	1
Ø 190 mm			
22319	Ø 190 x 20 mm	40	1
22320	Ø 190 x 30 mm	40	1
Ø 200 mm			
22322	Ø 200 x 30 mm	24	1
22324	Ø 200 x 30 mm	40	1
22326	Ø 200 x 30 mm	60	1
Ø 205 mm			
22328	Ø 205 x 30 mm	40	1
22329	Ø 205 x 30 mm	60	1
Ø 210 mm			
22332	Ø 210 x 30 mm	40	1
22333	Ø 210 x 30 mm	60	1
Ø 250 mm			
22335	Ø 250 x 30 mm	40	1
22337	Ø 250 x 30 mm	60	1
Ø 300 mm			
22340	Ø 300 x 30 mm	40	1
22343	Ø 300 x 30 mm	60	1
22345	Ø 300 x 30 mm	96	1
Ø 350 mm			
22350	Ø 350 x 30 mm	40	1
22351	Ø 350 x 30 mm	54	1
Ø 400 mm			
22355	Ø 400 x 30 mm	40	1
22357	Ø 400 x 30 mm	60	1
Ø 500 mm			
22365	Ø 500 x 30 mm	60	1
Ø 600 mm			
22370	Ø 600 x 30 mm	60	1



FESTA

CIRCULAR SAW BLADE TCT

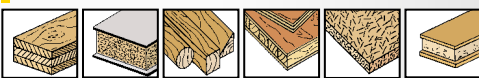

DISTANCE RING

No.	specification	
22399	Ø 20 16 mm	1
22398	Ø 30 25 mm	1

FESTA

OSCILLATING MULTI-TOOL ACCESSORY SET

for 28045



4x

3x BI-METAL



1x SK5

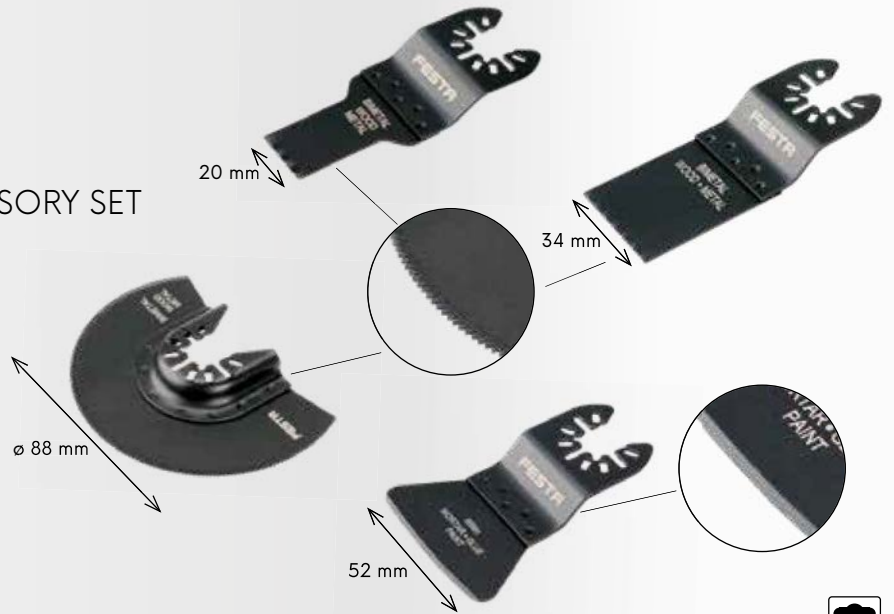

No. specifications

24322



10

FESTA

OSCILLATING MULTI-TOOL ACCESSORY SET

for 28045



4x

3x CARBIDE



1x

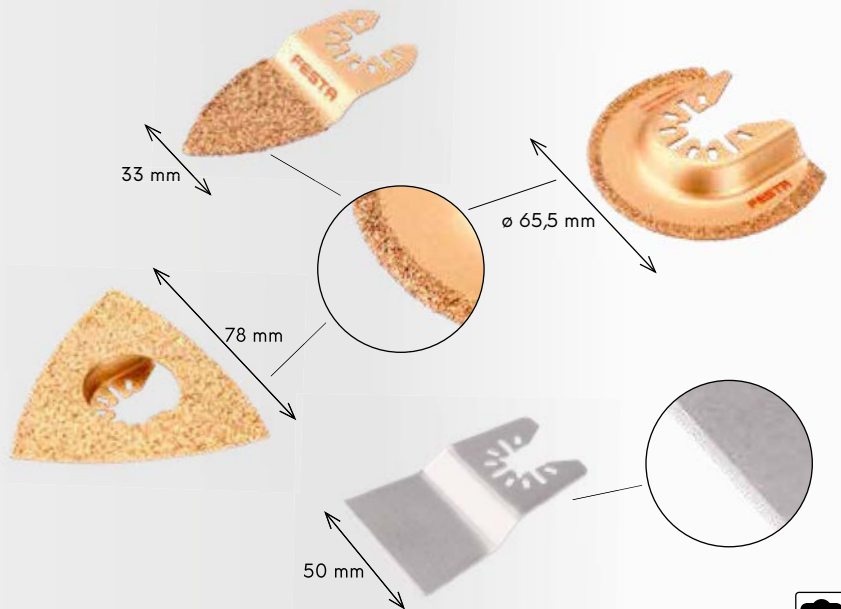

No. specifications

24321



10

OSCILLATING MULTI-TOOL ACCESSORY SET

for 28045



HCS 3x

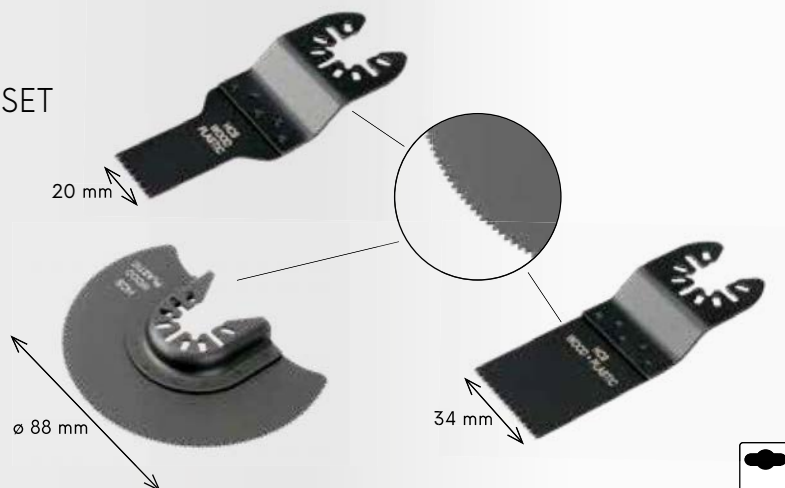

No. specifications

24320



10

PROFESSIONAL JIG SAW BLADES
MADE IN GERMANY BY CAUTERIZING WITH LASER



JIG SAW BLADES FIT JIG SAW LIKE: AEG, BOSCH, FESTO, MAKITA, METABO

	24060	50mm/1mm	0,7 mm/ 36TPI	31007	5 pcs	10	
	24061	50mm/1mm	1,2 mm/ 21TPI	31012	5 pcs	10	
	24062	50mm/1mm	2,0 mm/ 13TPI	31020	5 pcs	10	
	24063	75mm/1mm	3,0 mm/ 8TPI	31030	5 pcs	10	
	24064	100mm/1mm	1,2 mm/ 21TPI	31112	5 pcs	10	
	24065	100mm/1,3mm	2,0 mm/ 13TPI	31112	5 pcs	10	
	24066	75mm/1,45mm	2,0 mm/ 13TPI	31220	5 pcs	10	
	24067	120mm/1,3mm	1,8 - 2,4 mm/ 10 - 14 TPI	31220	5 pcs	10	
	24068	75mm/1,45mm	2,5 mm/ 10 TPI	32225	5 pcs	10	
	24069	75mm/1,45mm	4 mm/ 6 TPI	32240	5 pcs	10	
	24070	75mm/1,3mm	4 mm/ 6 TPI	32340	5 pcs	10	
	24071	75mm/1,3mm	4 mm/ 6 TPI	32440	5 pcs	10	
	24072	75mm/1,45mm	2,5 mm/ 10 TPI	32625	5 pcs	10	
	24073	85mm/1,45mm	3 mm/ 8 TPI	32730	5 pcs	10	
	24074	85mm/1,45mm	4 mm/ 6 TPI	32730	5 pcs	10	
	24075	75mm/1,45mm	2,5 1,2 mm/10 21 TPI	32825	5 pcs	10	
	24076	75mm/1,7mm	4 mm 6 TPI	32940	5 pcs	10	
	24077	120mm/1,3mm	4 mm 6 TPI	32040	5 pcs	10	
	24078	105mm/1,45mm	4 mm 6 TPI	34040	5 pcs	10	
	24055	55mm	carbide		5 pcs	1	

JIG SAW BLADES FIT JIG SAW LIKE: BLACK & DECKER, SKIL, FERM

	24080	50mm 1,0 mm	1,2 21 TPI	11012	5 pcs	10	
	24081	75mm 1,0 mm	3,0 8 TPI	11030	5 pcs	10	
	24082	75mm 1,45 mm	2,5 10 TPI	12225	5 pcs	10	
	24083	75mm 1,45 mm	4 6 TPI	12240	5 pcs	10	
	24084	75mm 1,3 mm	4 6 TPI	12340	5 pcs	10	
	24085	50mm 1,0 mm	2,0 13 TPI	12420	5 pcs	10	
	24086	75mm 1,3 mm	4,0 6 TP	12440	5 pcs	10	
	24087	75mm 1,45 mm	2,5 10 TPI	12625	5 pcs	10	

	mild steel		sheet metal		stainless steel		laminated boards
	non-ferrous-metals		hard and soft wood		chipboards		plastic
	plywood		batten board		nail infested wood		
	sandwichmaterial		tile		aluminium		

JIG SAW BLADES STAND

- items in stand - 24060 · 5 pcs
- 24080 · 5 pcs
- 24061 · 5 pcs
- 24062 · 5 pcs
- 24081 · 5 pcs
- 24063 · 5 pcs
- 24066 · 5 pcs
- 24067 · 5 pcs
- 24082 · 5 pcs
- 24068 · 5 pcs
- 24083 · 5 pcs
- 24069 · 5 pcs
- 24084 · 5 pcs
- 24070 · 5 pcs
- 24086 · 5 pcs
- 24071 · 5 pcs
- 24087 · 5 pcs
- 24072 · 5 pcs
- 24073 · 5 pcs
- 24074 · 5 pcs
- 24075 · 5 pcs
- 24076 · 5 pcs



JIG SAW BLADES SET



5x



No.	specification	
24045		50

No.	specification	
24099	64 x 50 cm - without blades	1
24098	64 x 50 cm - with blades	1

FESTA

SAW BLADE

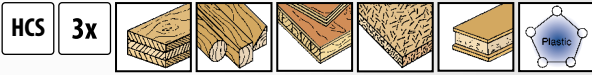

No.	specification	
24301	150 x 19 x 1,3 mm TPI 6	1

FESTA

SAW BLADE



No.	specification	
24302	225 x 19 x 1,3 mm TPI 3	1

FESTA

SAW BLADE

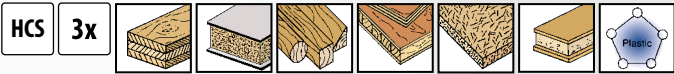

No.	specification	
24303	200 x 19 x 1,3 mm TPI 6 - 10	1

FESTA

SAW BLADE

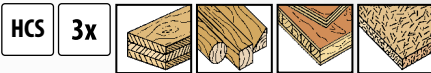

No.	specification	
24304	240 x 19 x 1,5 mm TPI 5	1

FESTA

SAW BLADE

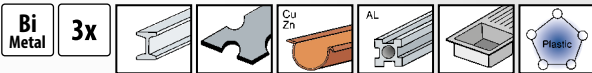

No.	specification	
24305	150 x 19 x 1 mm TPI 24	1

FESTA

SAW BLADE

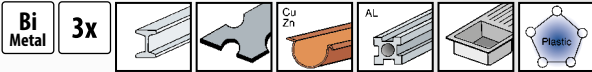

No.	specification	
24306	150 x 19 x 1 mm TPI 9	1

FESTA

SAW BLADE



No.	specification	
24308	225 x 19 x 1 mm TPI 10 - 14	1

FESTA

SAW BLADE



No.	specification	
24310	150 x 22 x 1,6 mm TPI 9	1

FESTA

SAW BLADE

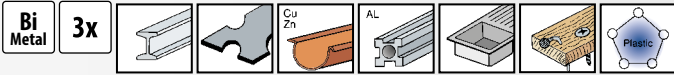

No.	specification	
24313	225 x 22 x 1,6 mm TPI 6	1

FESTA

HSS JIG SAW FOR METALS

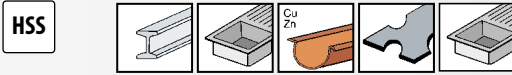

No.	specification	
24050	203 x 19 x 1 mm TPI 10 - 14	25

FESTA

SAW BLADE

· carbide technology, long life

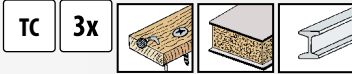

No.	specification	
24312	225 x 19 x 1,3 mm TPI 6 - 9	1

FESTA

SAW BLADE



No.	specification	
24315	305 x 50 x 1,5 mm	1
24316	455 x 50 x 1,5 mm	25

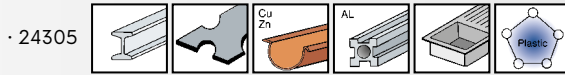
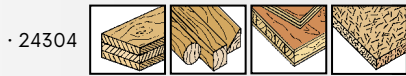
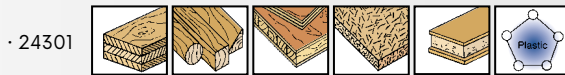

FESTA

SAW BLADE SET



No.	specification	
24314		1



FESTA

HANDLE FOR SAW BLADES

· handle + 2x saw blade
· for reciprocating saw blades



No.	specifications	
24325		1





FESTA
INDUSTRY



HACKSAW BLADE

· heat treated teeth



No.	specification	
24185	533 mm	1
24186	610 mm	1
24187	760 mm	1
24188	800 mm	1
24189	914 mm	1

FESTA

SAW BLADE

· heat treated teeth



No.	specification	
24169	350 mm	10
24167	450 mm	10
24166	533 mm	10
24163	610 mm	10
24164	760 mm	10
24168	800 mm	10
24165	914 mm	10



HACKSAW BLADE



No.	specification	
24195	span 3 mm 300 mm	1
24196	span 4 mm 300 mm angled tooth	1
24197	span 5 mm 300 mm hardened tooth	1
24192	blade for butcher saw 450 mm	1

HACKSAW BLADE

No.	specification	
24160	span 3 mm 300 mm	20
24161	span 4 mm 300 mm	20
24162	span 5 mm 300 mm	50



HACKSAW BLADE

10x



No.	specification	
24108	6 mm 150 mm	1

ROD SAW BLADE



No.	specification	
24120	300 mm	50

FESTA

SAW BLADE BI - METAL

8 % COBALT

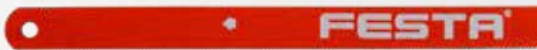

No.	specification	
24180	300 mm	125

FESTA

HACKSAW BLADE



MOQ



No.	specification	
24109	12,5 mm 300 mm for metal	144
24118	25 mm 300 mm for metal double sided	72
24119	25 mm 300 mm for metal and wood	72





96

MEASURING TAPE



101

FOLDING RULE



104

RULES AND SQUARES



106

SPIRIT AND SCREEDING
LEVELS

112

LASER MEASURING
DEVICE

116

PENCILS AND MARKERS



120

SPRAYERS



122

CUTTERS



137

CUTTERS, PLIERS FOR
PVC PIPES

140

SCREWDRIVERS



146

BITS



154

SOCKET SETS AND RATCHETS



159

HEADS, EXTENSIONS,
ADAPTERS

164

SPANNERS



169

PLIERS



179

TINSMITH PLIERS



182

RIVETERS



188

FILES AND RASPS



190

SAWS FOR WOOD, METAL
AND ETC

195

HAMMERS, MALLETS



203

CLAMPS

WORKSHOP TOOLS

94 - 205



KOMELON®

· HIGHLY PRECIOUS AND QUALITY MEASUREMENTS

- II. class accuracy reg. ČSN 251104, EEC 755345
- nylon coating of the blade DURA NY Coat™ guarantees 10x higher resistant of the measuring blade

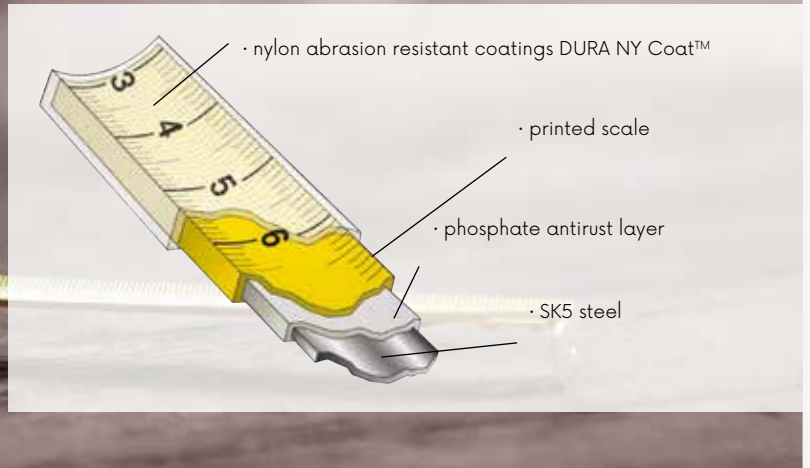

· Nylon abrasion resistant coatings DURA NY Coat™

KOMELON® MEASURING TAPE



No.	specification	
10002	2 m · 16 mm	10
10003	3 m · 16 mm	10
10005	5 m · 19 mm	10
10008	8 m · 25 mm	10



· Nylon abrasion resistant coatings DURA NY Coat™

KOMELON® MEASURING TAPE



No.	specification	
10025	5 m · 25 mm	10



· Nylon abrasion resistant coatings DURA NY Coat™

KOMELON® MEASURING TAPE

- automatic break
- anti-slip rubber coating



No.	specification	
10033	3 m · 16 mm	6
10035	5 m · 19 mm	6



KOMELON® MEASURING TAPE



No.	specification	
10043	3 m · 16 mm	30
10045	5 m · 19 mm	30
10048	8 m · 25 mm	12



KOMELON® LONG STEEL TAPE



No.	specification	
10110	10 m · 10 mm	6
10120	20 m · 10 mm	6
10130	30 m · 10 mm	6



KOMELON® FIBERGLASS TAPE



No.	specification	
10330	10 m · 13 mm	6
10332	20 m · 13 mm	6
10334	30 m · 13 mm	6
10336	50 m · 13 mm	6



KOMELON®
FIBERGLASS TAPE



No.	specification	
10430	30 m · 13 mm	1
10450	50 m · 13 mm	1
10490	100 m · 13 mm	1



· illustration photo

PROMOTIONAL STAND

No.	specification	
10998		1

KOMELON®
PROMOTIONAL STAND

· items in stand 10996

- 10003 · 5 pcs
- 10005 · 4 pcs
- 10008 · 1 pcs
- 10033 · 2 pcs
- 10035 · 3 pcs
- 10045 · 2 pcs
- 10025 · 3 pcs
- 10110 · 1 pcs
- 10120 · 1 pcs
- 10130 · 1 pcs
- 10430 · 1 pcs
- 10330 · 1 pcs
- 10332 · 1 pcs
- 10334 · 1 pcs
- 10336 · 1 pcs



· illustration photo

No.	specification	
10999	promotional stand for measuring tapes	1
10996	stand filled with items	1



· Information about the tape



A · length of tape

B · accuracy class

C · declaration of conformity - CE

D · year of manufacture

E · the number of the accredited certification office issuing the certificate

F · producer

G · special tape adjustment

H · the temperature at which the test was performed

FESTA



FESTA
MEASURING TAPE

- scale with big numerals
- anti-slip rubber coating
- nylon coat

No.	specification	
11353	3 m · 19 mm	12
11355	5 m · 19 mm	12
11356	5 m · 25 mm	12
11358	8 m · 25 mm	6
11360	10 m · 25 mm	6



FESTA
MEASURING TAPE

- nylon coat
- ABS housing
- chrome coated metal clip
- automatic break
- antislip rubber coating PTE
- hanger

No.	specification	
11343	3 m · 16 mm	6
11345	5 m · 19 mm	6
11347	7,5 m · 25 mm	6



FESTA
MEASURING TAPE - MAGNET

- 3 x break
- magnetic hook
- lock up
- anti-slip rubber coating

No.	specification	
11323	3 m · 19 mm	10
11325	5 m · 25 mm	10
11327	7,5 m · 25 mm	6



FESTA
MEASURING TAPE
MAGNETIC

- magnetic hook
- anti-slip rubber coating
- fluorescent tape
- scale with big numerals

No.	specification	
11102	2 m · 16 mm	10
11103	3 m · 16 mm	10
11105	5 m · 19 mm	12
11106	5 m · 25 mm	12
11107	7,5 m · 25 mm	10
11110	10 m · 25 mm	6



FESTA
MEASURING TAPE

- scale with big numerals

No.	specification	
11226	2 m · 16 mm	10
11239	3 m · 19 mm	10
11259	5 m · 19 mm	12
11260	7,5 m · 25 mm	6



FESTA
MEASURING TAPE

- automatic break
- anti-slip rubber coating

No.	specification	
11333	3 m · 16 mm	12
11335	5 m · 19 mm	12
11337	7,5 m · 25 mm	6
11338	10 m · 25 mm	6



FESTA
MEASURING TAPE COMPACT

- small size of measuring tape
- nylon coat

No.	specification	
11220	3 m · 16 mm	12
11221	5 m · 19 mm	12



Johnny®

MEASURING TAPE

· matt adjustment of tape

II. class



No.	specification	
11002	2 m · 13 mm	12
11003	3 m · 13 mm	12
11005	5 m · 13 mm	12
11006	5 m · 19 mm	12
11007	7,5 m · 19 mm	12
11008	10 m · 25 mm	12



MEASURING TAPE - ERGO

· lock up
· anti-slip rubber coating



No.	specification	
11082	2 m · 16 mm	12
11083	3 m · 16 mm	12
11085	5 m · 19 mm	12



MEASURING TAPE

· metric and inch scale
· anti-slip rubber coating



No.	specification	
11416	5 m · 19 mm	10



MEASURING TAPE

· lock up



No.	specification	
11200	2 m · 13 mm	24
11201	2 m · 16 mm	24
11202	2 m · 19 mm	24
11204	3 m · 13 mm	24
11205	3 m · 16 mm	24
11206	3 m · 19 mm	24
11207	5 m · 19 mm	12
11208	5 m · 25 mm	12
11209	7,5 m · 25 mm	12
11210	10 m · 25 mm	12

MEASURING TAPE WITH PRINTED NAME, 3M · 16 MM

CE II. class

Č.p.	jméno na metru	Č.p.	jméno na metru	Č.p.	jméno na metru	Č.p.	jméno na metru
13500	JIŘÍ	13509	MIROSLAV	13518	VÁCLAV	13527	MISTR
13501	PETR	13510	BIG BOSS	13519	JAKUB	13528	ONDŘEJ
13502	JOSEF	13511	ZDENĚK	13520	LUKÁŠ	13529	MAREK
13503	TOMÁŠ	13512	MICHAL	13521	2X MĚŘ	13530	STANISLAV
13504	JAN	13513	MILAN	13522	LADISLAV	13531	BOREC
13505	MARTIN	13514	KAREL	13523	DAVID	13532	TATÍNEK
13506	JAROSLAV	13515	VLADIMÍR	13524	ROMAN	13533	ANTONÍN
13507	FRANTIŠEK	13516	DĚDEČEK	13525	ŠIKULA	13534	ALEŠ
13508	PAVEL	13517	MŮJ METR	13526	RADEK		



10



FESTA

LONG STEEL TAPE

· loop

CE II. class



No.	specification	
12010	10 m · 10 mm	1
12020	20 m · 10 mm	1
12030	30 m · 10 mm	1
12050	50 m · 10 mm	6



FESTA

FIBERGLASS TAPE

· loop

CE II. class



No.	specification	
12110	10 m · 13 mm	6
12120	20 m · 13 mm	1
12130	30 m · 13 mm	1
12150	50 m · 13 mm	1



FESTA

LONG STEEL TAPE

· loop + hook

CE II. class



No.	specification	
12220	20 m · 10 mm	6
12230	30 m · 10 mm	6
12250	50 m · 10 mm	6



FESTA

LONG STEEL TAPE

· loop



No.	specification	
12433	30 m · 12,5 mm	20
12435	50 m · 12,5 mm	10



MEASURING WHEEL

- resistant, light and compact
- counter attribute when moving forward and subtract when moving back
- built-in lighting - 2 x AAA bateries in handle
- with bag



No.	specification	
15989	max. 10 km	2



FESTA

TELESCOPIC MEASURING POLE

· with bag

No.	specification	
15983	0,7 - 3 m	10
15985	1,1 - 5 m	10
15988	1,6 - 8 m	5



FLAT SELF ADHESIVE METAL MEASURING TAPE



No.	specification	
11311	1 m · 12,5 mm	30
11312	2 m · 12,5 mm	30
11313	3 m · 16 mm	30
11314	5 m · 19 mm	30



MEASURING TAPE KEYCHAIN

No.	specification	
11420	1 m · 6 mm orange	24



FESTA

MEASURING TAPE KEYCHAIN

- scale with big numerals
- properties of classical measuring tape



No.	specification	
11410	2 m · 16 mm 6 colour	12



MEASURING TAPE KEYCHAIN

No.	specification	
11444	1 m · 6 mm white	20



MEASURING TAPE KEYCHAIN

No.	specification	
11425	1 m · 6 mm	25



LIBELA - KEYCHAIN

No.	specification	
11445		100

FOLDING RULE



No.	specification	
13010	1 m · white	20
13020	2 m · white	10
13021	1 m · yellow	20
13022	2 m · yellow	10
13023	2 m · white - yellow	10



FOLDING RULE



No.	specification	
13111	1 m · yellow	10
13120	2 m · yellow	5

FOLDING RULE



No.	specification	
13211	1 m	1
13220	2 m	1



FOLDING RULE WITH NAME



No.	name	No.	name		
13401	JIRÍ	13426	DANIEL	10	
13402	JAN	13427	ANTONÍN		
13403	PETR	13428	VOJTĚCH	13451	JANA
13404	JOSEF	13429	FILIP	13452	EVA
13405	PAVEL	13430	ADAM	13453	PETRA
13406	MARTIN	13431	MILOSLAV	13454	MAJKA
13407	JAROSLAV	13432	MATĚJ	13455	HANA
13408	TOMÁŠ	13433	ALEŠ	13456	ANNA
13409	MIROSLAV	13434	JAROMÍR	13457	LENKA
13410	ZDENĚK	13435	LIBOR	13458	KATKA
13411	FRANTIŠEK	13436	DOMINIK	13459	LUCIE
13412	VÁCLAV	13437	PATRIK	13460	ALENA
13413	MICHAL	13438	VLASTIMIL	13461	VERONIKA
13414	MILAN	13439	JINDŘICH	13462	MARTINA
13415	KAREL	13440	MILOŠ	13463	JITKA
13416	JAKUB	13441	JÁN	13464	BIG BOSS
13417	LUKÁŠ	13442	PETER	13465	2 x MĚŘ
13418	DAVID	13443	ONDREJ	13466	TATÍNEK
13419	VLADIMÍR	13444	JOZEF	13467	DĚDEČEK
13420	LADISLAV	13445	PAVOL	13468	ŠIKULA
13421	ONDŘEJ	13446	L'UBOMÍR	13469	MISTR
13422	ROMAN	13447	KAROL	13470	MACHR
13423	STANISLAV	13448	RADOSLAV	13471	BOREC
13424	MAREK	13449	VOJTĚCH	13472	UŽ JE MŮJ
13425	RADEK	13450	ZDENKO	13473	MŮJ METR

STAND FOR FOLDING RULE

· items in stand 13399

- 13401 · 15 pcs
- 13402 · 15 pcs
- 13403 · 15 pcs
- 13404 · 15 pcs
- 13405 · 15 pcs
- 13406 · 15 pcs
- 13412 · 15 pcs
- 13413 · 15 pcs
- 13414 · 15 pcs
- 13415 · 15 pcs
- 13416 · 15 pcs
- 13417 · 15 pcs
- 13418 · 15 pcs
- 13419 · 15 pcs
- 13420 · 15 pcs
- 13421 · 10 pcs
- 13422 · 10 pcs
- 13423 · 10 pcs
- 13424 · 10 pcs
- 13425 · 10 pcs
- 13426 · 10 pcs
- 13427 · 10 pcs
- 13428 · 10 pcs
- 13429 · 10 pcs
- 13430 · 10 pcs
- 13431 · 10 pcs
- 13432 · 10 pcs
- 13433 · 10 pcs
- 13434 · 10 pcs
- 13435 · 10 pcs
- 13436 · 10 pcs
- 13437 · 10 pcs
- 13438 · 10 pcs
- 13439 · 10 pcs
- 13440 · 10 pcs



No.	specification	
13399	Stand filled with items	1
13400	Only stand without items	1



FESTA

WORKSHOP CALIPER DIGITAL



No.	specification	
14007	150 0,01 mm	10
14008	200 0,01 mm	10
14009	300 0,01 mm	10

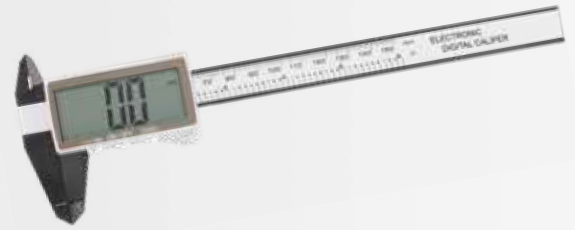

WORKSHOP CALIPER DIGITAL FIBERGLASS

· accuracy 0.2 mm, resolution 0.1 mm

No.	specification	
14013	150 0,2 mm	10

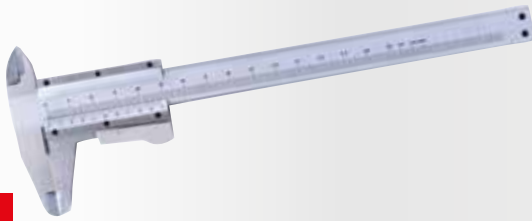

FESTA

WORKSHOP CALIPER



No.	specification	
14004	150 0,02 mm	10

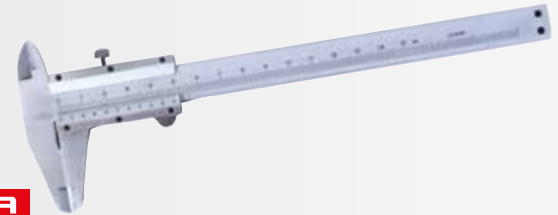

FESTA

WORKSHOP CALIPER



No.	specification	
14001	150 0,02 mm	10
14002	200 0,02 mm	10
14003	300 0,02 mm	10



FESTA

OUTSIDE MICROMETER



No.	specification	
14040	0 - 0,25 0,01 mm	10
14045	25 - 50 0,01 mm	10



WORKSHOP CALIPER

HOBBY

No.	specification	
14006	150 mm	50



FESTA

DIAL INDICATOR



No.	specification	
14035	0 - 10mm 0,01 mm	10



FEELER GAGES

· 20 leaves



No.	specification	
14080	0,05 - 1 mm	10



DRAWING-COMPASS



No.	specification	
13285	200 mm	10



FESTA

MARKING TOOL



No.	specification	
13281	150 mm	50



FESTA

MARKING TOOL



No.	specification	
13282	200 mm	50

FESTA

RULER WITH HANDLE

ALU



No.	specification	
14030	600 mm	6

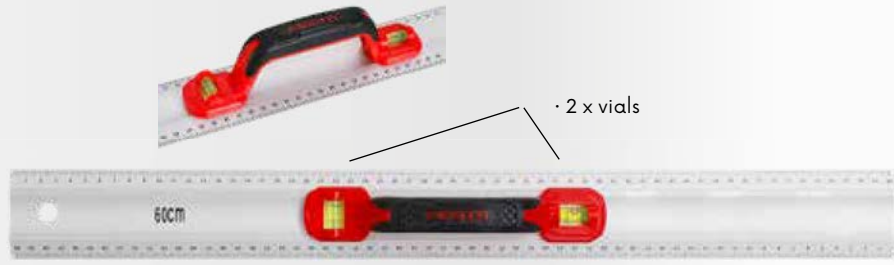

FESTA

RULER ALUMINIUM

ALU



No.	specification	
14015	400 mm	48
14017	600 mm	50
14019	1000 mm	40



FESTA

STAINLESS STEEL RULER

INOX



No.	specification	
14010	300 mm	10
14011	600 mm	10
14012	1000 mm	10



FESTA

PROTRACTOR

· with case

No.	specification	
14060	0° - 180° · 150 x 200 mm	10
14070	0° - 180° · 300 x 500 mm	5

PROTRACTOR

HOBBY

No.	specification	
14075	0° - 180° · 230 x 500 mm	30



MULTIPURPOSE FOLDING RULER

No.	Specification
14077	



10



MULTIPURPOSE RULE



No.	specification	
14480	250 x 120 mm	1



CONTOUR DUPLICATOR TEMPLATE



No.	specification	
14090	125 x 30 mm	1
14091	250 x 30 mm	1

FESTA

MULTIFUNCTION SQUARE 3D



No.	specifications	
14418		10



FESTA

MULTIFUNCTION SQUARE



No.	specification	
14420	180 mm	10
14421	300 mm	10

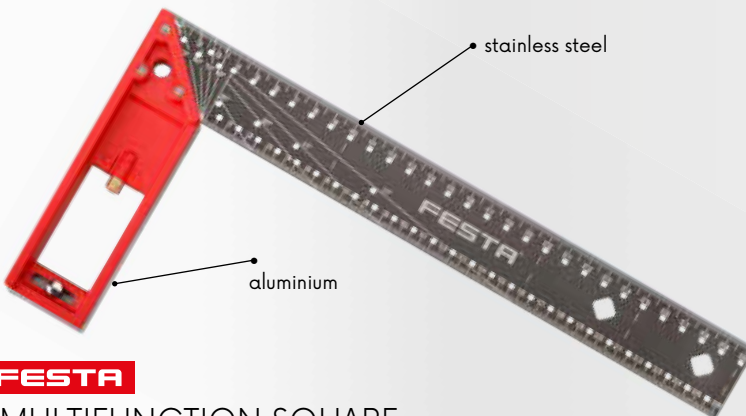

FESTA

MULTIFUNCTION SQUARE



No.	Specification	
14415	300 mm	6
14417	400 mm	6

FESTA

SQUARE - FOLDABLE

ALU



No.	specification	
14445	600 x 600 mm	1
14446	1200 x 1200 mm	1

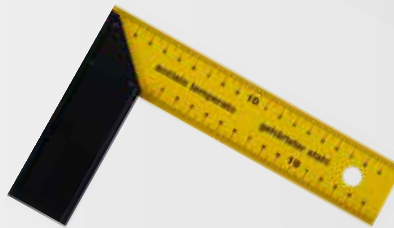

FESTA
SQUARE

ALU



No.	specification	
14450	190 x 355 mm	6
14451	200 x 405 mm	6

FESTA
SQUARE



No.	specification	
14220	200 x 125 mm	10
14225	250 x 135 mm	10
14230	300 x 135 mm	10
14235	350 x 190 mm	10
14240	400 x 190 mm	10
14250	500 x 210 mm	10

FESTA
SQUARE



No.	specification	
14350	500 x 235 mm	10
14360	600 x 300 mm	10
14370	700 x 300 mm	10
14380	800 x 320 mm	10
14399	1000 x 360 mm	10

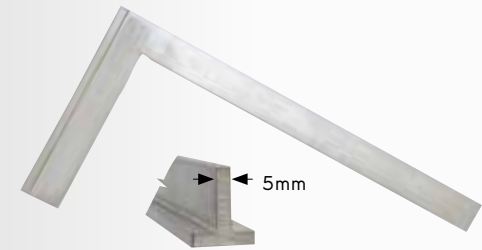
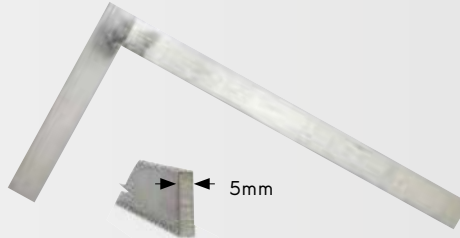
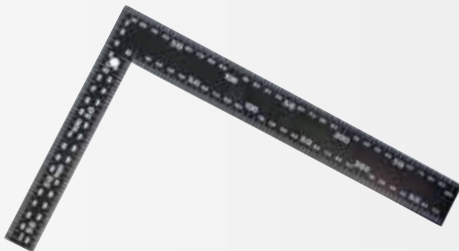

SQUARE

No.	specification	
14410	300 x 200 mm	50
14411	600 x 400 mm	36

SQUARE FLAT

Zn

No.	specification	
14471	150 x 100 mm	25
14472	250 x 125 mm	25
14473	400 x 200 mm	30
14474	600 x 300 mm	25

SQUARE

Zn

No.	specification	
14490	100 x 50 mm	10
14491	150 x 75 mm	10
14492	250 x 125 mm	10
14493	400 x 200 mm	10
14494	600 x 300 mm	10



SQUARE

No.	specification	
14455	300 x 200 mm	50
14456	500 x 250 mm	50
14457	700 x 300 mm	40
14458	1000 x 450 mm	30

TRY SQUARE

ALU HOBBY

No.	specification	
14425	250 x 130 mm	12
14430	300 x 130 mm	12
14435	350 x 156 mm	12
14440	400 x 156 mm	12

BEVEL SQUARE WOODEN



No.	specification	
14025	255 x 285 mm	1

MADE IN EUROPE

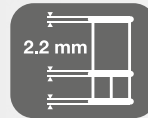
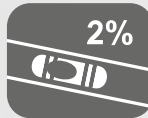

Every piece is electronically tested and has its evidence number, the producer is the holder of certificate ISO 90001



HORIZONT
MASTER



HORIZONT
LEVEL MASTER, 2 VIALS

ALU

No.	specification	
15033	60 cm	10



HORIZONT
LEVEL MASTER, 3 VIALS

ALU

No.	specification	
15034	80 cm	10
15035	100 cm	10



HORIZONT
LEVEL MASTER, 3 VIALS, 2 HANDLES

ALU

No.	specification	
15036	120 cm	10
15037	150 cm	10
15039	200 cm	10

HORIZONT®

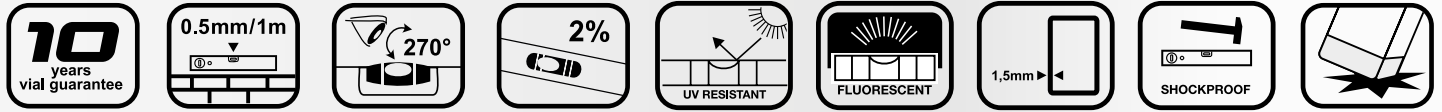

Every piece is electronically tested and has its evidence number, the producer is the holder of certificate ISO 9001

HORIZONT® LEVEL, 2 VIALS



No.	specification	
15003	30 cm	30
15004	40 cm	30
15005	50 cm	30
15006	60 cm	30
15008	80 cm	30
15010	100 cm	30
15012	120 cm	10
15015	150 cm	10
15018	180 cm	10
15020	200 cm	10



HORIZONT® LEVEL, 3 VIALS



No.	specification	
15103	30 cm	30
15104	40 cm	30
15105	50 cm	30
15106	60 cm	30
15108	80 cm	30
15110	100 cm	30
15112	120 cm	10
15115	150 cm	10
15118	180 cm	10
15120	200 cm	10



HORIZONT® LEVEL, 2 VIALS + MAGNET



No.	specification	
15204	40 cm	30
15205	50 cm	30
15206	60 cm	30
15208	80 cm	30
15210	100 cm	30
15212	120 cm	10
15215	150 cm	10
15218	180 cm	10
15220	200 cm	10



HORIZONT® GRADIENT LEVEL, 4 VIALS



No.	specification	
15230	80 cm	10

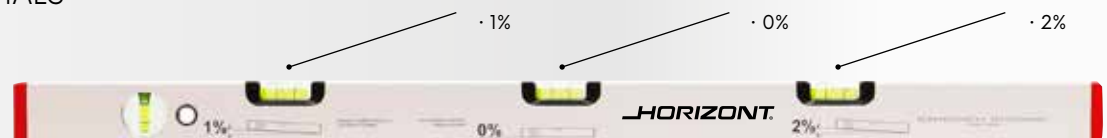

HORIZONT
GRADIENT LEVEL, 1 VIAL



No.	specification	
15235	60 cm	1



HORIZONT
MASON STAFF

ALU

No.	specification	
15310	100 cm	10
15315	150 cm	10
15318	180 cm	10
15320	200 cm	10
15325	250 cm	10
15330	300 cm	10
15335	350 cm	10
15340	400 cm	10



HORIZONT
MASON STAFF, 1 VIAL

ALU

No.	specification	
15415	150 cm	10
15418	180 cm	10
15420	200 cm	10
15425	250 cm	10
15430	300 cm	10



HORIZONT
MASON STAFF, 2 VIALS

ALU

No.	specification	
15510	100 cm	10
15515	150 cm	10
15518	180 cm	10
15520	200 cm	10
15525	250 cm	10
15530	300 cm	10
15535	350 cm	10
15540	400 cm	5



HORIZONT
MASON STAFF, 2 HANDLES, WITHOUT VIALS

ALU

No.	specification	
15615	150 cm	10
15620	200 cm	10
15625	250 cm	10
15630	300 cm	10



HORIZONT

MASON STAFF, 2 VIALS, 2 HANDLES

ALU

No.	specification	
15710	100 cm	10
15715	150 cm	10
15720	200 cm	10
15725	250 cm	10
15730	300 cm	10
15735	350 cm	10
15740	400 cm	5



HORIZONT

MASON STAFF, TRAPEZ

- PROFILE TRAPEZOIDAL
- trapezoidal profile for finer surface finishes
 - suitable for stuccoers and facades
 - suitable for thin-film plasters

ALU

No.	specification	
15810	100 cm	10
15812	120 cm	10
15815	150 cm	10
15818	180 cm	10
15820	200 cm	10
15825	250 cm	10
15830	300 cm	10



HORIZONT

MASON STAFF, "h" PROFIL

- PROFILE "h"
- "h" profile for finer surface finishes
 - suitable for stuccoers and facades
 - suitable for stucco plastering

ALU

No.	specification	
15850	100 cm	10
15853	150 cm	10
15855	180 cm	10
15860	200 cm	10
15870	250 cm	10
15880	300 cm	10



NEW

HORIZONT

CONNECTOR FOR SCREED LEVELS

ALU

No.	Specifications		
15301		1	



HORIZONT

MASON STAFF, 1 VIAL- ADJUSTABLE

ALU

No.	specifications	
15893	65 - 100 cm	1
15894	95 - 150 cm	1
15895	145 - 235 cm	1



HORIZONT

SQUARE

ALU

No.	specification	
14485	800 x 1200 mm	1
14486	1000 x 1500 mm	1



HORIZONT.
STAND FOR
LEVEL HORIZONT

· items in stand 15998

- 15003 · 5 pcs
- 15004 · 5 pcs
- 15005 · 5 pcs
- 15006 · 5 pcs
- 15008 · 5 pcs
- 15010 · 5 pcs
- 15012 · 5 pcs
- 15015 · 3 pcs
- 15018 · 3 pcs
- 15020 · 3 pcs
- 15108 · 3 pcs
- 15206 · 3 pcs
- 15210 · 3 pcs

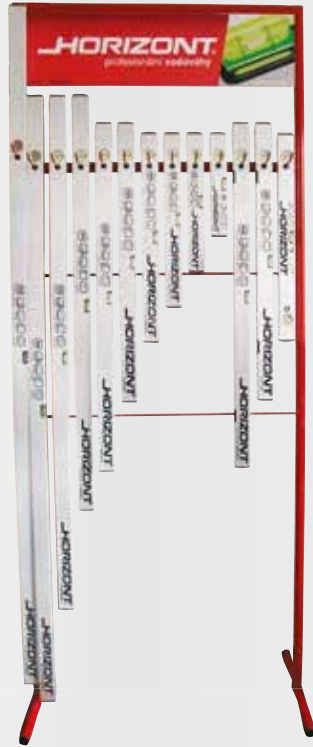

HORIZONT.
STAND FOR LEVEL AND
MASONRY STAFF HORIZONT

· items in stand 15996

- 15004 · 5 pcs
- 15005 · 5 pcs
- 15006 · 5 pcs
- 15008 · 5 pcs
- 15010 · 5 pcs
- 15012 · 5 pcs
- 15015 · 5 pcs
- 15018 · 5 pcs
- 15020 · 5 pcs
- 15315 · 2 pcs
- 15320 · 2 pcs
- 15325 · 3 pcs
- 15515 · 2 pcs
- 15520 · 2 pcs
- 15525 · 3 pcs



No.	specification	
15999	85 x 210 x 50 cm	1
15998	85 x 210 x 50 cm filled with items	1

No.	specification	
15997	55 x 75 x 40 cm	1
15996	55 x 75 x 40 cm filled with items	1

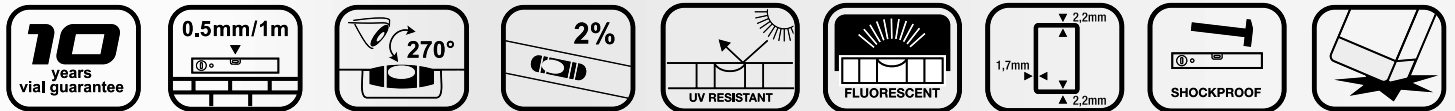

NEW

FESTA
LEVEL,
3 VIALS



No.	Specifications	
15754	400 mm	1
15756	600 mm	1
15758	800 mm	1
15760	1000 mm	1
15762	1200 mm	1
15768	1800 mm	1
15770	2000 mm	1



NIVELA

NIVELA LEVEL - 2 VIALS

- Accuracy 0,5 mm | 1 m (in the basic position)
- UV stable vials
- Shockproof rubber ends
- Profile thickness 2,4 mm

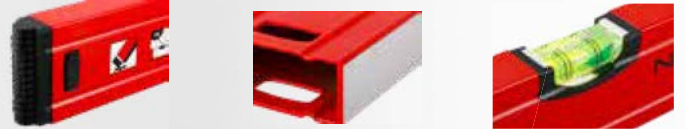

No.	specification	
15904	40 cm	30
15906	60 cm	30
15908	80 cm	30
15910	100 cm	30
15912	120 cm	20
15915	150 cm	10
15920	200 cm	20



NIVELA LEVEL - 3 VIALS

ALU HOBBY

No.	specification	
15954	40 cm	60
15956	60 cm	60
15958	80 cm	60
15960	100 cm	30
15962	120 cm	30
15965	150 cm	30
15970	200 cm	30



LEVEL TO HANG ON TWINE



No.	specification	
15981		1



No.	specification	
15980	230 mm	1

SPIRIT LEVEL FOR POLES

- 3 vials, magnets, fastening belt



No.	specification	
26028		12



GLASSPIPES WITH HOSE



No.	specification	
15992	glass pipes - hose 10 m	1
15993	glass pipes - hose 15 m	1
15990	glass pipes	50
15991	plastic pipes	50



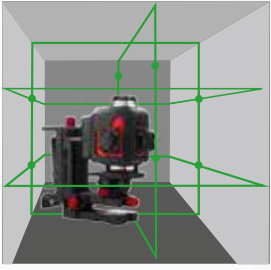

NEW

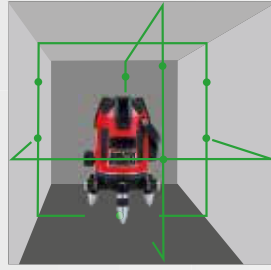

NEW



FESTA

LASER ALL LINE GREEN 4 x 360 °

- 2x horizontal plane + 2x vertical plane (green beam)
- self-levelling range $\pm 4^\circ$
- accuracy: 0,2 mm/m
- indoor: 30 m, outdoor with detector 50 m
- pulse mode – recommended accessory receiver 26209
- inclusive: carrying case, remote control, laser target, Li-ion battery 5200 mAh, professional bracket, mini tripod, charger

$\pm 4^\circ$	max. 50 m	± 0.2 mm/m	II. class	515 nm
1/4"	5/8"	IP54	Li-ion 3.7V 5.2Ah	

No. 26205 Specification 1



FESTA

CROSS-LINE GREEN LASER

- 1x horizontal plane + 4x vertical plane (green beam) + 1x dot
- self-levelling range $\pm 3^\circ$
- accuracy: 0,2 mm/m
- indoor: 20 m, outdoor with detector 50 m
- pulse mode – recommended accessory receiver 26209
- inclusive: carrying case, laser target, Li-ion battery 5200 mAh, professional bracket, mini tripod, charger

$\pm 3^\circ$	max. 50 m	± 0.2 mm/m	II. class	515 nm
5/8"	IP54	Li-ion 3.7V 5.2Ah		

No. 26203 Specification 1





FESTA

CROSS-LINE GREEN LASER 3D

- 1x horizontal plane+2x vertical plane(green beam)
- self-levelling range $\pm 4^\circ$
- accuracy 0,2 mm/m
- indoor: 30 m, outdoor with detector 50 m
- pulse mode – recommended accessory receiver 26209
- inclusive: carrying case, 4xAA alkaline batteries, laser target, goggles, 2600 mAh Li-ion battery, professional bracket, charger, cradle of Li-ion battery

$\pm 4^\circ$	INDOOR 30 m OUTDOOR 50 m	± 0.2 mm/m	II. class	515 nm
IP54	5/8"	1/4"	4x AA	Li-ion 7.4V 2.6Ah



No. Specification

26204

1



FESTA

CROSS-LINE GREEN LASER

- 1x horizontal plane+1x vertical plane(green beam)
- self-levelling range $\pm 3^\circ$
- accuracy 0,2 mm/m
- indoor: 20 m, outdoor with detector 50 m
- pulse mode – recommended accessory receiver 26209
- inclusive: carrying case, 2xAA alkaline batteries, bracket

$\pm 3^\circ$	INDOOR 20 m OUTDOOR 50 m	± 0.2 mm/m	II. class	515 nm
IP54	1/4"	2x AA		

No. Specification

26201

1

FESTA

RANGE-FINDER

- measuring range 0,05 - 50 m
- measuring accuracy ± 2 mm, measuring unit mm/in/ft
- continuous measurement, area measurement, volume measurement, triangle leg measurement, LCD FSTN, addition/subtraction, max./min. measurement, max storage 100 units, backlight, laser class 630-670 nm class 2
- operating temperature 0 - 40°C
- size 112 x 50 x 25 mm, weight 90 g
- inclusive: carrying case, 2xAAA alkaline batteries

max 50 m	± 2 mm	m in ft	630 670 nm
IP54	2x AAA		

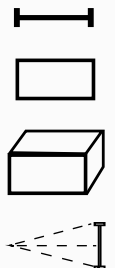

No. Specification

26211

1



FESTA

LASER RECEIVER

- for use with pulsed laser devices to extend the range then 50 m
- inclusive: 9 V battery, bracket
- for 26201, 26203, 26204, 26205

max 50 m	±1.5 mm 10 m	5 kHz	IP54	1x 9V
--------------------	------------------------	--------------	-------------	--------------

No.	Specification	Icon
26209	range: 50 m	1

1/4" + 5/8"



60 - 150 cm

TRIPOD

ALU

No.	specifications	Icon
26219	45 - 120 cm. 1/4" + 5/8"	1

FESTA

DIGITAL INCLINOMETER

- 0° - 360°
- accuracy ±0,1°
- resolution 0,1°
- auto-off function
- HOLD function for measured value storing
- backlight display
- dimensions 60x60x25 mm
- battery 1xAAA



· bag

· magnetic bottom side

0-360°	0.1° LCD DISPLAY	1x AAA	0-50°C	82 g
---------------	----------------------------	---------------	---------------	-------------

No.	specification	Icon
26218		1



FESTA

DIGITAL PROTRACTOR

200 mm	mm inch	LCD DISPLAY	0°-360°
0.05°	+/- 0.2°	MANUAL LOCKING	1x CR2032 3V

No.	specification	Icon
26217	200 mm	1



FESTA

DIGITAL PROTRACTOR

- LCD display
- measuring range 0° - 225°
- resolution 0,1°
- accuracy ± 0,3

ALU	0.1° LCD DISPLAY	3V LITHIUM
------------	----------------------------	-------------------

No.	specification	Icon
26216	300 mm	1

FESTA

MULTIMETER

- DC voltage measurement: 200 mV - 300 V
- AC voltage measurement: 200 mV - 300 V
- DC current measurement: 2000 µA - 10 A
- resistance measurement: 200 Ω - 2 MΩ
- battery check: 1.5V, 9V
- low battery indication
- overload protection

- IEC61010
- CATIII 300V
- GS certificate
- power supply: 9 V battery (6F22)
- dimensions: 70×128×28 mm
- weight: 137 g (with battery)
- accessories: test cables



No.	specifications
18429	



1

FESTA

VOLTAGE TESTER

- AC / DC - 6 V, 12 V, 24 V, 50 V, 120 V, 230 V, 400 V
- resistance to water penetration IP54
- polarity
- CAT III 400 V



No.	specifications
18428	



1

Laserliner®

LUXTEST-MASTER

Professional lighting intensity measuring instrument

- Measurement of lighting intensity in workplaces, offices, public buildings and industry
- Sensitive photodiode with cosine correction for wide-angle light measurement
- Relative measurement function for reference and comparison measurement
- Peak function for registering fast changes in light levels
- Hold function
- Automatic and manual range changeover
- Zeroing function
- Measurement variables: Lux (lm |m²), foot candle (lm |ft²)
- Min |Max display
- 1 |4" tripod connection



No.	specification
-----	---------------

	Measuring range :	20 Lux ... 200000 Lux
26520	Lux accuracy:	± 3% (reference light bulb at 2854 K)
	Cosine angular deviation:	± 2% (30°), ± 6% (60°)



1

specification
Inclusive: battery, carrying case

Laserliner®

AIRFLOWTEST-MASTER

Professional anemometer for measuring air flow, volumetric flow and wind speed

- Integrated sensor for measuring ambient temperature, relative humidity and dew point calculation
- USB interface for saving measured data
- PC software for real-time logging
- Large impeller: 65 mm
- Min |Max display
- 1 |4" tripod connection for long-term measurement
- Illuminated, clearly arranged display with permanently visible ambient temperature and relative humidity



No.	specification
-----	---------------

	Flow rate:	0.80...30 m s ± 2%
26521	Ambient temperature:	-10...60°C ± 1.5°C
	Relative humidity:	20%...80% ± 3%
	Airflow:	0...99990 CMM



RECORDING ON A PC

specification
Inclusive: PC software, USB Cable, batteries, carrying case



1



FESTA

CARPENTER PENCILS HB



MOQ 12

No.	specification	MOQ
13270	HB · 180 mm	96
13271	HB · 180 mm · set 3 pcs	32
13265	HB · 250 mm	96



FESTA

CARPENTER PENCIL HB



MOQ 50



No.	specification	MOQ
13269	HB · 180 mm	50
13266	HB · 250 mm	50



FESTA

CARPENTER PENCIL HB



MOQ 12

No.	specification	MOQ
13272	HB · 250 mm	96
13264	HB · 250 mm · without print	96



FESTA

CARPENTER PENCIL HB



MOQ 50



No.	specification	MOQ
13268	250 mm	50



FESTA

TRIANGULAR PENCIL HB

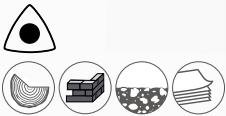

MOQ 12

No.	specification	MOQ
13278	250 mm	96



FESTA

PENCIL 6H

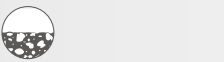

MOQ 12

No.	specification	MOQ
13275	6H · 250 mm	96



FESTA

PENCIL FOR GLASS, CERAMICS



MOQ 12

No.	specification	MOQ
13273	175 mm red graphite - glass. ceramics	144



FESTA

PENCILS WITH COLORFULL GRAPHITE

No.	specification	MOQ
13274	175 mm, red - blue	96



CARPENTER PENCIL HB



MOQ
12

No.	specification	
13280	180 mm	96



PENCILS WITH RED GRAPHITE

MOQ
12

No.	specification	
13276	175 mm	144



· sanding paper

PENCIL SHARPENER



No.		
13261		12



FESTA

AUTOMATIC PENCIL WITH CLIP HB

· spare pencils 13263, 13267



No.	specifications	
13288		20



FESTA

STEEL PENCIL WITH CLIP HB

· spare pencils 13263, 13267



No.	specification	
13262	150 mm	20



FESTA

PENCIL WITH REMOVABLE GRAPHITE HB



No.	specification	
13279	pencil + graphite HB	24
13284	spare graphite 5 pcs	20



FESTA

COLORED PENCILS FOR CARPENTER PENCIL

· pro | for 13262, 13288



No.	Specification	
13267	● 2x yellow ● 2x red ● 2x blue	1



FESTA

BLACK PENCILS HB FOR CARPENTER PENCIL

· for 13262, 13288



No.	Specification	
13263	● 6x black	1





PERMANENT MARKER



No.	Specifications	
13200	○ white	1
13201	● black	1
13202	● red	1



NEW

PERMANENT MARKER



- extra strong tip
- for marking even on greasy and wet surfaces



MOQ
12

No.	specification	
13216	red	12
13217	black	12
13218	blue	12
13219	green	12



PERMANENT MARKER



- 2 types of markers tip
- for marking even on greasy and wet surfaces



No.	specification	
13227	white ALU pen body	40
13222	white PVC pen body	12
13228	red ALU pen body	40
13229	black ALU pen body	40
13230	blue ALU pen body	12
13231	green ALU pen body	12



PERMANENT MARKER



MOQ
12



No.	specification	
13214	white	12
13225	red	12
13226	black	12
13223	blue	12
13224	green	12



PERMANENT MARKER



MOQ
12



No.	specification	
13235	red	12
13236	black	12
13237	blue	12
13238	green	12



FESTA

PERMANENT MARKER



No.	Specification	
13246	● black	1
13247	● red	1
13248	○ white	1



TWO SIDED PERMANENT MARKER - DIFFERENT THICKNESS



MOQ 12



No.	Specification	
13206	○ white	12



TWO SIDED PERMANENT MARKER - DIFFERENT THICKNESS



MOQ 12



No.	specification	
13212	black	12



TWO SIDED PERMANENT MARKER - DIFFERENT THICKNESS



MOQ 12



No.	Specification	
13207	● red	12
13208	● blue	12



PERMANENT MARKER MINI



· length of marker 9 cm

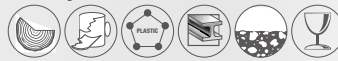

MOQ 72



No.	specification	
13205	● ● ● ●	72



FESTA

UNIVERSAL MARKER SET 5 PCS

· Ø 13 x 110 mm

5x



No.	specification	
13240	5 colour	20
13241	● red	20
13242	● black	20

No.	specification	
13243	● yellow	20
13244	● green	20
13245	○ white	20



MOBILE SPREY HOLDER FOR SPRAY SOPPEC

· For spray trackmarker and Fluo



No.	specification	
13296		1



WAX CRAYON SET 6 PCS

6x



No.	specification	
13277	● ● ● ● ● ●	88



WHITE CHALK

12x



No.	specification	
13260	12 x 12 x 80 mm	46



PISTOL SPREY HOLDER FOR SPRAY SOPPEC

· For spray trackmarker and Fluo



No.	specification	
13295		1



SPRAY FLUORESCENT TRACKMARKER 500 ML

- High visibility due to fluorescent pigment
- Safety cap
- Quick drying 10 min.
- Durability 3 months
- Use - Concrete, Asphalt, Grass, Gravel, Sand, Stone, Wood

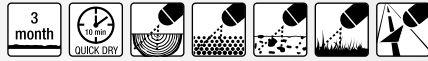

No.	specification	
13250	● yellow	12
13251	● red	12
13252	● orange	12
13253	● green	12
13254	● pink	12
13249	● blue	12



SPRAY FLUORESCENT MARK 6M FLUO 500 ML

- High visibility due to fluorescent pigment
- Safety cap
- Quick drying 10 min.
- Durability 6 months
- Use - Concrete, Asphalt, Grass, Gravel, Sand, Stone, Wood, Glass



No.	specification	
13360	● yellow	12
13361	● red	12
13362	● orange	12
13363	● green	12
13364	● pink	12
13365	○ white	12



SPRAY FLUORESCENT FLUO 500 ML

- High visibility due to fluorescent pigment
- Safety cap
- Quick drying 10 min.
- Durability 12 months
- Use - Concrete, Asphalt, Grass, Gravel, Sand, Stone, Wood, Glass



No.	specification	
13350	● yellow	12
13351	● red	12
13352	● orange	12
13353	● green	12
13354	● pink	12
13355	○ white	12



SPREY FLUORESCENT IDEAL 500 ML

- High visibility due to fluorescent pigment
- Safety cap
- Quick drying 10 min.
- Durability 12 months
- Use - Concrete, Asphalt, Grass, Gravel, Sand, Stone, Wood



No.	specification	
13255	● yellow	12
13256	● red	12
13257	● orange	12
13258	● green	12
13259	● pink	12



KDS®

Knives of Japanese company KDS

- excellent ergonomics of grips
- high performance and lifespan of blades
- blades of the best materials
- low cutting resistance enabling easy cutting



KDS® CUTTER



No.	specification		
16002	LC405 18 mm green	25	
16011	LB10 spare blade	10	



KDS® CUTTER



No.	specification		
16003	G11 18 mm + 2 spare	10	
16012	GB10 spare blade	10	



KDS® CUTTER



No.	specification		
16019	L19 18 mm + 2 spare	10	
16011	LB10 spare blade	10	
16012	GB10 spare blade	10	



KDS® CUTTER



No.	specification		
16004	H11 25 mm	10	
16013	HB10 spare blade	10	



KDS® CUTTER



No.	specification		
16005	S14 9 mm + 2 spare blade	10	
16010	SB10 spare blade	10	



KDS® SCALPEL



No.	specification		
16006	D12 + 16 spare blade	10	

KDS® SPARE BLADES



No.	specification		
16010	SB10 9 0,38 mm	13 segments	20
16011	LB10 18 0,5 mm	15 segments	20
16012	GB10 18 0,6 mm	15 segments	20
16013	HB10 25 0,7 mm	7 segments	10



KDS® SPARE BLADES

- special alloy
- double grinding
- enhanced lifetime
- low cutting resistance
- enabling easy cutting



No.	specification		
16016	LB10B 18 0,5 mm	8 segments	20
16017	HB10B 25 0,7 mm	7 segments	10



KDS® STAND FOR BLADES

No.	specification		
16999	stand	1	
16998	filled stand with items	1	



- items in stand 16998 - 16001 · 5 pcs
- 16003 · 5 pcs
- 16004 · 3 pcs
- 16005 · 3 pcs
- 16006 · 2 pcs
- 16008 · 3 pcs
- 16010 · 4 pcs
- 16012 · 4 pcs
- 16013 · 1 pcs
- 16016 · 4 pcs
- 16018 · 4 pcs
- 16019 · 4 pcs
- 16020 · 4 pcs

• illustration picture



FESTA



blade breaking system



FESTA
INDUSTRY

CUTTER

· Anti-Slip rubber coating



No.	specifications	
16099	18 mm	12

FESTA[®]



FESTA[®]

**CUTTER,
CERAMIC BLADE**

- 3x sharper than the steel blade
- 10x longer lifetime
- Refractory, non-conductive, non-magnetic



No.	specification	
16131	18 mm	10
16066	spare blade 18 mm, 5 pcs	10



FESTA[®]

CUTTER



No.	specification	
16110	L11 18 mm + 1 spare blade	12



FESTA[®]

CUTTER



No.	specification	
16100	L12 18 mm + 1 spare blade	12

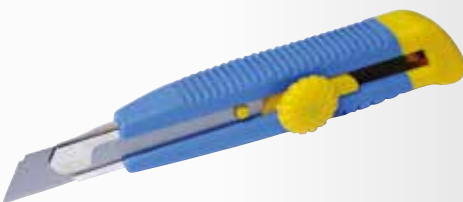

FESTA[®]

CUTTER



No.	specification	
16105	L17 18 mm + 1 spare blade	12



FESTA[®]

CUTTER



No.	specification	
16125	L4 9 mm	24
16120	L8 18 mm	24



FESTA[®]

CUTTER



No.	specification	
16115	L10 9 mm	24



FESTA
CUTTER

No.	specification	
16150	18 mm MOQ	24
16151	18 mm without logo FESTA	20



FESTA
CUTTER

No.	specification	
16136	18 mm	12



FESTA
CUTTER

No.	specification	
16137	25 mm	12



FESTA
CUTTER
· Anti-Slip rubber coating

No.	specification	
16090	18 mm	12



FESTA
CUTTER
· Anti-Slip rubber coating

No.	specification	
16091	25 mm	6



FESTA
CUTTER
· Anti-Slip rubber coating

No.	specification	
16145	L25 18 mm	12



FESTA
CUTTER
· Anti-Slip rubber coating

No.	specification	
16144	L24 18 mm	12



CUTTER

No.	specification	
16143	18 mm	12



CUTTER

No.	specification	
16142	18 mm	12 1



CUTTER

No.	specification	
16025	18 mm	12



FESTA
CUTTER

No.	specification	
16029	18 mm	25



FESTA
CUTTER
· Anti-Slip rubber coating

No.	specification	
16146	18 mm	12



FESTA

CUTTER

· Anti-Slip rubber coating

No.	specification	
16147	25 mm	12



FESTA

CUTTER

· Anti-Slip rubber coating

No.	specification	
16130	L18 18 mm + 5 spare blade	12



FESTA

CUTTER

· Anti-Slip rubber coating

No.	specification	
16135	L20 25 mm + 5 spare blade	6



FESTA

CUTTER

· Anti-Slip rubber coating

No.	specification	
16140	L22 18 mm	12



FESTA

CUTTER

· Anti-Slip rubber coating

No.	specification	
16034	25 mm	12



FESTA

CUTTER

No.	specification	
16085	9 mm	24



FESTA

CUTTER

No.	specification	
16086	18 mm	24



SAFETY KNIFE

No.	specifications	
16044		20



SAFETY KNIFE

· self-retracting blade

No.	specification	
16057	135 mm	12



FESTA

SAFETY KNIFE

No.	specification	
16058		6
16074	spare blade 10 pcs	1



16074



NEW



FESTO

CUTTER KNIFE WITH SCRAPER

+2 SK4



No.	Specifications	
16039		6
16087	spare blades	1



FESTO

CUTTER

+5 ALU



No.	specification	
16037	+ 5 spare blade	6



FESTO

FOLDING KNIFE

+5 ALU



No.	specification	
16023	knife + 5 spare blade	12
16071	spare blade 10 pcs	10



FESTO

FOLDING KNIFE - SET

ALU

No.	specification	
16095	25 blade	1

PRECISION CRAFT KNIFE KIT

22x



No.	specification	
16282		24



PRECISION CRAFT KNIFE KIT

13x



No.	specification	
16281		10



FESTO

CUTTER

· Anti-Slip rubber coating

ALU +2



No.	specification	
16035	+ 2 spare blade	12



FESTO

DOLPHINE CUTTER

ALU +3



No.	specification	
16033	NP 110 + 3 spare blade	5





DOLPHINE CUTTER

ALU



No.	specification	
16032	NP 109	48



ADJUSTABLE CUTTER

ALU

No.	specification	
16031	NS 107 B	24



CUTTER

ALU

No.	specification	
16030	NS 107	24



CUTTER

ALU



No.	specification	
16046	18 mm	12



CUTTER

No.	specification	
16028	S 201 18 mm	24



CUTTER

No.	specification	
16026	P 205 18 mm	30



CUTTER

HOBBY



No.	specification	
16021	P 201 9 mm	60



CUTTER

HOBBY

No.	specification	
16024	P 204 18 mm	60



CUTTER

Anti-Slip rubber coating

No.	specification	
16141	18 mm	24



CUTTER SET

HOBBY 12x

No.	specification	
16053	9 mm	12
16055	18 mm	12



CUTTER SET

HOBBY 3x

No.	specification	
16043		24





CUTTER FOR CARPETS

· for carpet and flooring

No.	specification	
16036	45 mm	12



CUTTER HOOKED FOR FLOORS

· for carpet and flooring

No.	specification	
16041		12



50 mm

WINDOW SCRAPER

ALU		
No.	specification	
16059	50 mm	10
16082	spare blade	1



100 mm

WINDOW SCRAPER

· for use with 18 mm blades for cutters

ALU		
No.	specification	
16054	100 mm	1



100 mm

WINDOW SCRAPER

No.	specification	
16052	48 cm lenght	6
16070	spare blade	25



38 mm

FESTA

SCRAPER WITH RUBBER HANDLE

· Anti-Slip rubber coating

No.	specification	
16049		12
16069	spare blade	1



60 mm

WINDOW SCRAPER

No.	specification	
16051		24



55 mm

WINDOW SCRAPER

No.	specification	
16050		24



SET OF SCRAPERS FOR APPLICATION AND REMOVING SILICONE

3x		
No.	specification	
16042		12

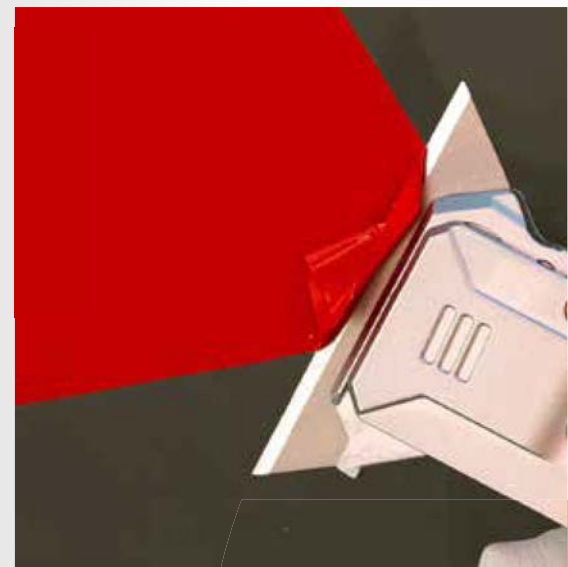



FESTA

SPARE BLADES

- segments
- 3x longer life
- double grinding
- low cutting resistance

SK2 10x



No.	specification	
16064	25 0,7 mm	20



FESTA

SPARE BLADES

- segments
- 3x longer life
- double grinding
- low cutting resistance

SK2 10x



No.	specification	
16062	18 0,7 mm	10



FESTA

SPARE BLADES

- segments
- 3x longer life
- double grinding
- low cutting resistance

SK2 10x



No.	specification	
16063	18 0,7 mm	10



FESTA

SPARE CERAMIC BLADE

- segments
- 3x sharper than the steel blade
- 10x longer lifetime
- Refractory, non-conductive, non-magnetic

5x



No.	specification	
16066	18 0,6 mm	10



SPARE BLADES

- segments
- double grinding

10x



No.	specification	
16078	18 0,5 mm	25



SPARE BLADES

- segments
- double grinding

10x



No.	specification	
16077	18 0,6 mm	25



SPARE BLADES

- segments

10x



No.	specification	
16068	25 0,6 mm	20



SPARE BLADES

- segments

10x



No.	specification	
16065	18 0,5 mm	60



SPARE BLADES

- segments

10x



No.	specification	
16081	18 0,5 mm	60



SPARE BLADES

- segments

10x



No.	specification	
16067	18 0,5 mm	10



SPARE BLADES 30°

- 7 segments

10x



No.	specification	
16061	9 0,4 mm	60



SPARE BLADES

- 13 segments

10x



No.	specification	
16060	9 0,45 mm	10



FESTA

SPARE BLADES

10x



No.	specification	
16072	R 004	10



FESTA

SPARE BLADES

10x



No.	specification	
16075	R 003	10

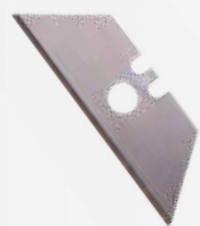

SPARE BLADES

10x

No.	specification	
16071	R 001	60

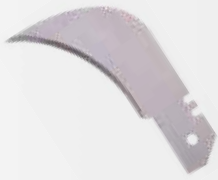

SPARE BLADES

5x

No.	specification	
16083	18 mm	50



SPARE BLADES

10x

No.	specification	
16073	R 002	60



SPARE BLADES

5x

No.	specification	
16084	18 mm	50

FESTA

SPARE BLADES

· for 16058

10x

No.	specification	
16074		1



SPARE BLADES

· for 34315

No.	specification	
34316		1



SPARE BLADES FOR SCRAPER

· for 16052

No.	specification	
16070	100 mm	25



FESTA

KNIFE FOR MINERAL WOOL

No.	specification	
16198	44,5 33 cm	12



FESTA

KNIFE FOR ISOLATION

· for mineral wool, polystyrene

No.	specification	
16199	48 35 cm	10



FESTA

MACHETE

TEFLON

No.	specification	
45069	490 mm	6

3 mm



FESTA

MACHETE

TEFLON

No.	specification	
44950	490 mm	4

3 mm



MACHETE STAINLESS STEEL

INOX

No.	specification	
45083	430 mm	12
45084	600 mm	6



MACHETE

· handle made out of ash wood

No.	specification	
45081	510 mm	36
45082	710 mm	36



FESTA

KNIFE

- nylon handle
- teflon coated blade
- case with fuse and clip



INOX	TEFLON	NYLON	No.	specification	
			16234	21 10 cm	10



FESTA

HUNTING KNIFE



INOX	TEFLON	No.	specification	
		16229	23 10 cm	12



3 mm

FESTA

MULTIFUNCTION CHISEL

- thickened blade



INOX	No.	specification	
	16231	20 8 cm	12



TECHNICAL KNIFE

- thickened blade

INOX	No.	specification	
	16230	21 10 cm	12



FESTA

KNIFE FOR CARPETS AND FLOORING

No.	specification	
16225	20 8,5 cm	12



FESTA

ELECTRICIAN KNIFE

- thickened blade

INOX	No.	specification	
	16212	15 3,2 cm	12



FESTA

STRIPPER CUTTER

No.	specification	
16201	Ø 8 - 27 mm	10



FESTA

ELECTRICIAN KNIFE

INOX	No.	specification	
	16211	20 8,5 cm	10



FESTA

ELECTRICIAN KNIFE

INOX	No.	specification	
	16210	20,5 9 cm	10



FESTA

INOX INOCULATION KNIFE



INOX	No.	specification	
	16219	19 11 cm	24



FESTA

INOX PLANT KNIFE



INOX	No.	specification	
	16218	18,5 10,5 cm	24



FESTA

INOX LOCK KNIFE



INOX	No.	specification	
	16220	18,5 11 cm	24



FESTA

INOX POCKET KNIFE



INOX	No.	specification	
	16235	17,5 8,5 cm	24



FESTA

INOX POCKET KNIFE



INOX	No.	specification	
	16221	21 12 cm	24



FESTA

INOX POCKET KNIFE



INOX	No.	specification	
	16236	22,5 10 cm	24



FESTA

INOX POCKET KNIFE



INOX	No.	specification	
	16209	14,5 5,5 cm	1



FESTA

INOX POCKET KNIFE



INOX	No.	specification	
	16222	20 12 cm	24



FESTA

INOX ALU POCKET KNIFE



INOX	ALU	No.	specification	
		16223	18,5 10,5 cm	24



FESTA

POCKET KNIFE MULTIFUNCTION

· 5 functions

INOX	No.	specification	24
	16228	27 10,5 cm	



FESTA

POCKET KNIFE MULTIFUNCTION

· 10 functions

INOX	No.	specification	24
	16226	17,5 7 cm	



POCKET KNIFE MULTIFUNCTION

· 7 functions

INOX	No.	specification	24
	16224	17,5 7 cm	



HUNTING LOCK KNIFE

· 3 functions

No.	specification	24
16227	20,5 10 cm	



FESTA

MULTIFUNCTION PLIERS

· 9 functions

· bag

CrV	No.	specification	12
	16232		



NEW



FESTA

DRAWKNIFE

CrV	No.	Specifications	1
	24132	250/490 mm	



JACK - PLANE



No.	specification	1
19510	220 x 65 x 130 mm, knife 48 mm	



JACK - PLANE



No.	specification	1
19515	200 x 55 x 130 mm, knife 39 mm	



JACK - PLANE



No.	specification	1
19520	225 x 27 x 155 mm, knife 27 mm	



FESTA

CHISEL

CrV

No.	specification	
19490	6 mm 290 mm	6
19491	8 mm 290 mm	6
19492	10 mm 290 mm	6
19493	12 mm 290 mm	6
19494	14 mm 290 mm	6
19495	16 mm 290 mm	6



FESTA

MULTIFUNCTION CHISEL

INOX

No.	specification	
16231	20 80 mm	12



FESTA

CHISEL SET WITH SHARPPENER STONE

CrV

5x

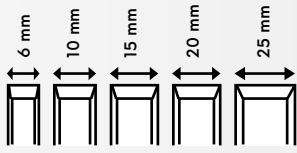

No.	specification	
19451		10



FESTA

CHISEL SET

CrV

4x

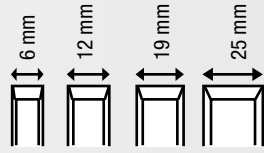

No.	specification	
19457		10



CHISEL SET

4x

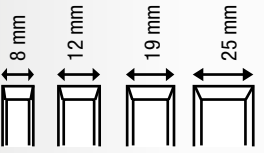

No.	specification	
19455		30

FESTA



FESTA

CHISEL SET

CrV

8x

No.	specification	
19458	365 125mm	1



CHISEL SET

4x

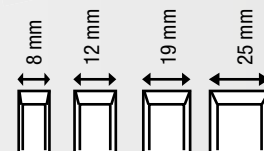

No.	specification	
19450		20



CHISEL SET

12x CrV

No.	specification	
19459		5

FESTA

SHARPENER FOR KNIVES AND SCISSORS 16v1



	30° Anvil	
	45° Anvil	
	50° Anvil	
	23° Bypass	
	35° Bypass	
	65° Bypass	
	Deburrr Tool	



No. specifications

45073



WHETSTONE ROUNDED

No. specification

45370

250 x 33 x 18 mm



WHETSTONE

No. specification

45045

150 x 50 x 30 mm



WHETSTONE

No. specification

45046

205 x 15 mm



SHARPENER FOR KNIVES AND SCISSORS

No. specification

16991



SHARPENER FOR KNIVES AND SCISSORS

No. specification

16990

Ø 50 mm



SHARPENER FOR KNIVES AND SCISSORS

No. specification

45048



SHARPENER FOR KNIVES AND SCISSORS 6 IN 1

No. specification

45068



WINLAND



WINLAND



FESTA
POWER X TOOLS

PIPE WELDER

- voltage / frequency 230 V / 50 Hz
- power consumption 750 / 1500 W
- temperature 0-300 C°
- extensions Ø 20,25,32,40,50,63 mm
- weight 1,6 kg



· package included: measuring tape, spirit level, screwdriver, hex key, 6x welding adapter, stand, shelf case



No.
17182



FESTA
POWER X TOOLS

PIPE WELDER

- voltage / frequency 230 V / 50 Hz
- power consumption 800 / 1000 W
- temperature 0-300 C°
- extensions Ø 16, 20, 25, 32 mm
- weight 1 kg



· package included: hex key, 4x welding adapter, stand, shelf case



No.
17183



FESTA

PLIERS FOR PVC PIPE

Ø max.
42 mm



No.	specification	
17027		10
16315	spare blade	1



SPARE BLADE FOR PLIERS

· for pliers 17027

No.	specification	
16315		1



FESTA



FESTA

PLIERS FOR PVC PIPE

Ø max.
32 mm



No.	Specification	
17037		12



PLIERS FOR PVC PIPE

Ø max.
42 mm

No.	specification	
17026		6



NEW

FESTA

PIPE CUTTER

INOX ALU

ALU Cu PVC



No.	Specifications	
16305	Ø 22 mm	10
16306	Ø 15 mm	10
16307 NEW	Ø 28 mm	10

NEW

FESTA

PVC PIPE CUTTER

PLASTIC INOX

PVC



No.	Specifications	
16308	Ø 20 - 50 mm	10

FESTA

PIPE CUTTER - SET

Ø 15 mm
Ø 22 mm
Ø 28 mm

3x INOX ALU

ALU Cu PVC



No.	Specifications	
16309		10



FESTA

PIPE CUTTER



3-22 mm



No.	specification	
16301		10
16311	spare blade	1

FESTA

PIPE CUTTER



6-64 mm



No.	specification	
16304		6
16312	spare blade	1

PIPE CUTTER



3-32 mm



No.	specification	
16303		10
16311	spare blade	1

PIPE CUTTER



3-32 mm



No.	specification	
16300		10
16310	spare blade	1



SPARE CIRCLE FOR PVC PIPE CUTTER



No.	specification	
16310	∅ 17,5 mm x 6 m for 16300	1
16311	∅ 18,0 mm x 4,5 mm for 16303, 16301	1
16312	∅ 27,5 mm x 6 mm for 16304	1



FESTA

PLIERS FOR THE PROFILE

· plinths, profiles, tubes

5x ∅ 17 mm ∅ 20 mm ∅ 27 mm

No.	specification	
17050	60 250 mm	8



NEW

FESTA

PLASTIC EDGE CLEANER



6-38 mm ALU



No.	Specifications	
16319	∅ 6 - 38 mm	1

FESTA

DEBURRER



1/4"

No.	specification	
16321		1

PLASTIC EDGE CLEANER



6-32 mm



No.	specification	
16320		1

FESTA

CLEAN CUTTER (MILLING) SET

HSS ∅ 25 mm 90°



No.	specification	
20360		10



DEBURRER



No.	specification	
20361		1



SCREWDRIVER



No.	specification	
18113	3 x 75 mm	12
18114	4 x 100mm	12
18115	5,5 x 125 mm	12
18116	6,5 x 150 mm	12
18118	8 x 175 mm	6
18120	10 x 200 mm	6



SCREWDRIVER SHORT

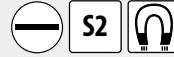

No.	specification	
18124	5,5 x 38 mm	12
18125	6,5 x 38 mm	12



PHILIPS SCREWDRIVER



No.	specification	
18210	0 x 75 mm	12
18211	1 x 75 mm	12
18212	2 x 100 mm	12



PHILIPS SCREWDRIVER SHORT

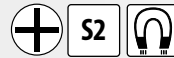

No.	specification	
18215	1 x 38 mm	12
18216	2 x 38 mm	12



POZIDRIVE SCREWDRIVER



No.	specification	
18310	0 x 75 mm	12
18311	1 x 100 mm	12
18312	2 x 100 mm	12
18313	3 x 150 mm	6



POZIDRIVE SCREWDRIVER SHORT

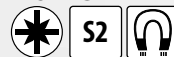

No.	specification	
18321	1 x 38 mm	12
18322	2 x 38 mm	12



TORX SCREWDRIVER



Č.p.	specifikace	
18350	T6	12
18351	T7	12
18352	T8	12
18353	T9	12
18354	T10	12
18355	T15	12
18356	T20	12
18357	T25	12
18358	T27	12
18359	T30	12
18360	T40	6



SCREWDRIVER FOR BITS + 7 BITS



- ⊖ S 5 · 6 mm
- ⊕ PH 1 · 2 · 3
- ⊛ T 15 · 20



SCREWDRIVER FOR BITS + 7 BITS



No.	specification	
18425		10



NEW



SCREWDRIVER AND BIT SET

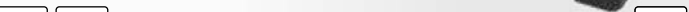

No.	specifications	
18434		1



- screwdriver for bits
- screwdriver for precision bits
- screwdrivers
 - ⊖ 3x75, 5x75, 5x100, 6x100, 6x150, 8x150
 - ⊕ 0x75, 1x75, 1x100, 2x100, 2x150
 - ⊛ T10x75, T15x75
 - ⊖ VDE 2.5x75mm, 4.0x100mm
 - ⊖ voltage tester
 - ⊖ 2.5x40, 3.0x40mm
 - ⊕ 00x40mm, 0x40mm,
 - ⊛ T6x40mm, T7x40mm
- hex
 - 1/16", 5/64", 3/32", 1/8", 5/32", 3/16", 7/32", 1/4"
 - 1.5, 2.0, 2.5, 3.0, 4.0, 5.0, 5.5, 6.0mm
- socket heads
 - 6mm, 7mm, 8mm, 9mm, 10mm, 11mm
- bits
 - ⊖ SL 3mm, 4mm, 4.5mm, 5mm, 5.5mm, 6mm, 7mm, 8mm
 - ⊕ PH0, PH0, PH1, PH1, PH2, PH2, PH3, PH3
 - ⊛ PZ0, PZ0, PZ1, PZ1, PZ2, PZ2, PZ3, PZ3,
 - ⊛ T6, T8, T10, T15, T20, T25, T27, T30, T35, T40
 - H1.5, H2.5, H3.0, H3.5, H4.0, H4.5, H5.0, H5.5, H6, H8
 - ⊖ S0, S1, S2, S3
- precision bits
 - ⊖ SL 1.5mm, 2.0mm, 2.5mm, 3.0mm, 4.0mm
 - ⊕ PH000, PH00, PH0, PH1
 - ⊛ T4, T5, T6, T7, T8, T9, T10, T15, T20
 - H0.7, H0.9



SCREWDRIVER SET

⊖ S 3x75 · 5x100 · 6,5x150mm

⊕ PH 0 · 1 · 2 · 3



7x



No. specification

18402

6



SCREWDRIVER SET

⊖ S 3x75 · 5x100 · 6x150mm

⊕ PH 0 · 1 · 2



6x



No. specification

18403

6



SCREWDRIVER SET

⊖ S 6,5x38 · 5,5x75 · 6,5x100 · 8x150 mm
2,5x50 · 3x50 mm

⊕ PH 2x38 · 1x75 · 2x100 · 3x150 mm
0x50 · 00x50 mm

⊛ T 5x50 · 6x50 · 7x50 · 8x50 · 9x50 · 10x50 mm



18x



No. specification

18424

6



SCREWDRIVER SET

⊖ S 3x75 · 5x100 · 6,5x150 mm

⊛ PZ 0 · 1 · 2



6x



No. specification

18404

6



SCREWDRIVER SET TORX

⊛ T 10 · 15 · 20 · 25 · 30



5x



No. specification

18340

6



SCREWDRIVER SET

⊖ S 3 x 75 · 4x100 · 5,5x125 · 6,5 x 150mm

⊕ PH1 x 100 · 2 x 100mm

⊖ adapter 1/4"

bits:

⊖ S 4 · 5 · 6 · 7

⊕ PH1 · 2 · 3

⊛ PZ1 · 2 · 3

⊛ T 10 · 15 · 20 · 25 · 30

⊖ H 2 · 3 · 4 · 5 · 6



27x



No. specification

18422

27 pcs

6





VDE SCREWDRIVER



Č.p.	specifikace		
18088	3 x 75 mm	S2	12
18089	4 x 100 mm	CrV	12
18090	5,5 x 125 mm	CrV	12
18091	6,5 x 150 mm	CrV	12
18092	8 x 175 mm	CrV	12



PHILIPS VDE SCREWDRIVER



Č.p.	specifikace		
18080	PH 0 x 60 mm	S2	12
18081	PH 1 x 80 mm	CrV	12
18082	PH 2 x 100 mm	CrV	12
18083	PH 3 x 150 mm	CrV	12

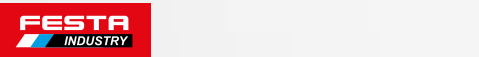

ELECTRO SCREWDRIVER SET



S 4x100 · 5,5x125 mm · voltage detector 0 - 250 V
PH 0x60 · 1x80 · 2x100 mm

Č.p.	specifikace	
18413		6



POZIDRIVE VDE SCREWDRIVER



Č.p.	specifikace		
18084	PZ 0 x 60 mm	S2	12
18085	PZ 1 x 80 mm	CrV	12
18086	PZ 2 x 100 mm	CrV	12
18087	PZ 3 x 150 mm	CrV	12



IMPACT SCREWDRIVER



Č.p.	specifikace		
18062	5,5 x 100 mm		12
18063	7 x 125 mm		6
18064	8 x 150 mm		8
18065	10 x 175 mm		6
18066	10 x 200 mm		6
18067	10 x 250 mm		6



ELECTRO SCREWDRIVER SET

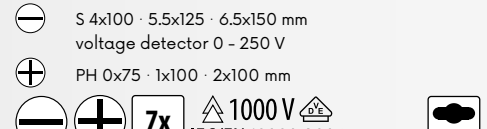

S 4x100 · 5,5x125 · 6,5x150 mm
voltage detector 0 - 250 V
PH 0x75 · 1x100 · 2x100 mm

Č.p.	specifikace	
18410		40



PHILIPS IMPACT SCREWDRIVER



Č.p.	specifikace		
18070	PH 1 x 80 mm		8
18071	PH 2 x 100 mm		12
18072	PH 3 x 150 mm		6



POZIDRIVE IMPACT SCREWDRIVER



Č.p.	specifikace		
18075	PZ 1 x 80 mm		12
18076	PZ 2 x 100 mm		12
18077	PZ 3 x 150 mm		6



SCREWDRIVER + 6 BITS

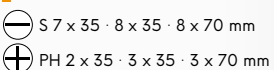

Č.p.	specifikace	
18411		1



SCREWDRIVER SET

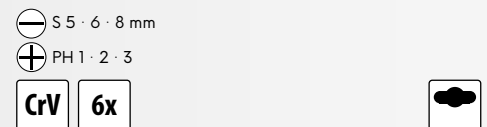

S 5 · 6 · 8 mm
PH 1 · 2 · 3

Č.p.	specifikace	
18423		10

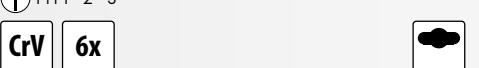



FESTA

SCREWDRIVER AND BIT SET

- ⊖ S 3x75 · 4x75 · 6x100 · 8x150 mm
- ⊕ PH 1x75 · 2x100 mm
- adapter 1/4"
- bits:
 - ⊖ S 4 · 5 · 6 · 7 mm
 - ⊕ PH 1 · 2 · 3
 - ✱ PZ 1 · 2 · 3
 - ⊙ T 10 · 15 · 20
 - ⊙ ↔ ⊠ adapter



No.	specification	
18418		10



FESTA

PHILIPS SCREWDRIVER

- ⊖ S 3x60 · 4x75 · 6x100 · 6x125 mm
- ⊕ PH 0x60 · 1x75 · 2x100 mm



No.	specification	
18400		10



FESTA

PHILIPS SCREWDRIVER

- ⊖ S 3x60 · 6x100 · 6x125 mm
- ⊕ PH 1x75 · 2x100 mm



No.	specification	
18401		1

FESTA

SCREWDRIVER



No.	specification	
18101	3 x 75 mm	10
18102	4 x 100 mm	10
18103	5,5 x 100 mm	10
18104	5,5 x 125 mm	10
18105	6,5 x 100 mm	10
18106	6,5 x 125 mm	10
18107	8 x 160 mm	10
18108	10 x 160 mm	10

FESTA

PHILIPS SCREWDRIVER



No.	specification	
18201	0 x 75 mm	10
18202	1 x 75 mm	10
18203	2 x 100 mm	10
18204	3 x 150 mm	10

FESTA

POZIDRIVE SCREWDRIVER



No.	specification	
18301	0 x 75 mm	10
18302	1 x 75 mm	10
18303	2 x 100 mm	10
18304	3 x 150 mm	10

FESTA

SCREWDRIVER FOR BITS



No.	specification	
18110		12



FESTA

SOCKET SCREWDRIVER

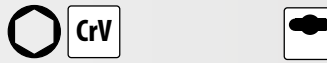

No.	specification	
18455	6 mm	12
18456	7 mm	12
18460	13 mm	12



FESTA

FLEXI SCREWDRIVER FOR HOSE CLAMPS

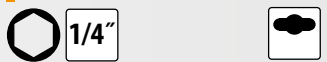

No.	specification	
18451		12



FESTA

FLEXI SCREWDRIVER FOR HOSE CLAMPS

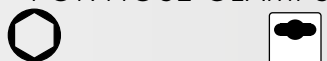

No.	specification	
18450	7 mm	6





SCREWDRIVER FOR BITS WITH RATCHET

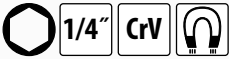

No. specification
18433

6



T SCREWDRIVER FOR BITS WITH RATCHET

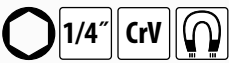

No. specification
18608

6



SCREWDRIVER + 20 BITS

- ⊖ S 3 · 4 · 5 · 6 · 8 mm
- ⊕ PH 0 · 1 · 2 · 3
- adapter + 5 · 6 · 7 · 8 · 9 · 10 · 11 · 12 · 13 mm



No. specification
18420

5



SCREWDRIVER WITH PRECISION BITS

- ⊖ S 1.5 · 2 · 2.5 · 3 · 3.5 mm
- ⊕ PH 000 · 00 · 0 · 1
- ⊛ PZ 0 · 1
- ⊛ T 5 · 6 · 7 · 8 · 9 · 10 · 15 · 20
- ⊛ H 0.9 · 1.3 · 2.0 · 2.5 · 3.0 · 4.0

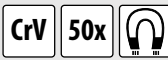

No. specification
18431

6



SCREWDRIVER RATCHET + BITS

- 1/4" ⊖ ↔ ⊕ 1/4"
- ⊖ S 3 · 4 · 5 · 6 · 7 · 5 L
 - ⊕ PH 1 · 2 · 3 · 1 L · 2 L
 - ⊛ PZ 1 · 2 · 3 · 1 L · 2 L
 - ⊛ H 2 · 2.5 · 3 · 4 · 5 · 6
 - ⊛ T 10 · 15 · 20 · 25 · 27 · 30
 - ⊛ SQ 0 · 1 · 2 · 3
 - 1/4" 5 · 6 · 7 · 8 · 9 · 10 · 11 · 12 · 13 mm



No. specification
18419

6



PRECISION SCREWDRIVER SET

- ⊖ S 1,5x50 · 2x50 · 2,5x50 mm
- ⊕ PH 000x50 · 00x50 · 0x50 mm



No. specification
18416

6



PRECISION SCREWDRIVER SET TORX

- ⊛ T 4 · 5 · 6 · 7 · 8 · 9 · 10x50 mm



No. specification
18417

6



PRECISION ELECTRO SCREWDRIVER SET

- ⊖ S 2,4 · 3,0 mm
- ⊕ PH 0 · 1
- ⊛ T 6 · 8



No. specification
18415

10



FESTTA

NEW



FESTTA

VOLTAGE DETECTOR

· AC - 110 V, 250 V



No.	Specifications	
18427		24

VOLTAGE DETECTOR

DIN VDE 0680
73/23 EEC



No.	specification	
18426	0 - 250 V	1

FESTTA

BOTTLE OPENER

No. specification

18437



5

PRECISION SCREWDRIVER SET

⊖ S 1,4 · 2,0 · 2,4 · 3,0 mm

⊕ PH 0 · 1



6x HOBBY



No.	specification	
18408		10



ANGLE ADAPTER FOR BITS 90°



No. 18910



25

BIT RATCHET



No. 18435 specification 93 mm



1

PRECISION SCREWDRIVER SET

⊖ S 1,0 · 1,2 · 1,4 · 1,8 · 2,4 · 3,0 mm

⊕ PH 00 · 0 · 1



11x HOBBY



No.	specification	
18409		48



IMPACT BIT PH - 50 MM



No.	specifications	
18715	PH1 x 50 mm	1
18716	PH2 x 50 mm	1
18717	PH3 x 50 mm	1



IMPACT BIT PZ - 50 MM



No.	specifications	
18710	PZ1 x 50 mm	1
18711	PZ2 x 50 mm	1
18712	PZ3 x 50 mm	1



IMPACT BIT T - 50 MM

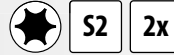

No.	specifications	
18720	T10 x 50 mm	1
18721	T15 x 50 mm	1
18722	T20 x 50 mm	1
18723	T25 x 50 mm	1
18724	T30 x 50 mm	1
18725	T40 x 50 mm	1



IMPACT BIT SET

- ⊕ PH 2 · 2
- ⊗ PZ 2
- ⊙ T 15 · 15 · 20 · 20 · 25 · 30 · 40

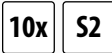

No.	specifications	
18432		1

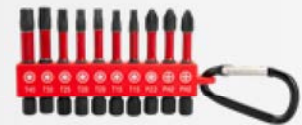

bits – professional screwing attachments of high alloyed material S2

Forged attachments

cross-headed and flat bits are made by special technology of precise forging. It enables achieving of high accuracy in shape, together with increasing in hardness in comparison with the bits by 20 %.

TiN layer

double applied on the surface of screwing spikes, it maximally increases the hardness, wipe resistance and frictional qualities prevent slipping out of the meshing.

Diamond grains

on the surface of the spike they really "bite" into the head of the wood screw or screw and enable to transfer maximum tightening torque. They are the best guarantee for staying in the meshing.

Nonskid grooves

on the working surfaces of the spikes made by forging are another very effective protection against the slipping out of the meshing.





BIT PH

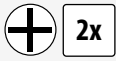

No.	specification	
18632A	PH2 x 25 mm	1
18633A	PH3 x 25 mm	1



BIT PZ

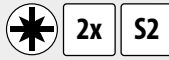

No.	specification	
18636A	PZ1 x 25 mm	1
18637A	PZ2 x 25 mm	1
18638A	PZ3 x 25 mm	1



BIT T

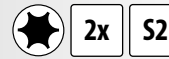

No.	specification	
18827A	T20 x 25 mm	1
18828A	T25 x 25 mm	1
18830A	T30 x 25 mm	1
18831A	T40 x 25 mm	1



BIT PH DIAMANT



No.	specification	
18770	PH1 x 25 mm	5
18771	PH2 x 25 mm	5
18772	PH3 x 25 mm	5



BIT PZ DIAMANT



No.	specification	
18775	PZ1 x 25 mm	5
18776	PZ2 x 25 mm	5
18777	PZ3 x 25 mm	5



BIT S

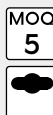
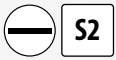

No.	specification	
18620	S 3 x 25 mm	5
18621	S 4 x 25 mm	5
18623	S 5 x 25 mm	5
18625	S 6 x 25 mm	5
18627	S 7 x 25 mm	5
18628	S 8 x 25 mm	5



BIT PH



No.	specification	
18630	PH0 x 25 mm	5
18631	PH1 x 25 mm	5
18632	PH2 x 25 mm	5
18633	PH3 x 25 mm	5
18634	PH4 x 25 mm	5



BIT PZ



No.	specification	
18635	PZ0 x 25 mm	5
18636	PZ1 x 25 mm	5
18637	PZ2 x 25 mm	5
18638	PZ3 x 25 mm	5
18639	PZ4 x 25 mm	5



BIT PH

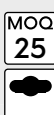

No.	specification	
18685	PH2 x 25 mm	25



BIT PZ

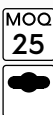

No.	specification	
18680	PZ2 x 25 mm	25



BIT PH



No.	specification	
18640	PH1 x 70 mm	10
18641	PH2 x 70 mm	10



BIT PZ



No.	specification	
18645	PZ1 x 70 mm	10
18646	PZ2 x 70 mm	10



BIT PH

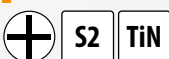

No.	specification	
18760	PH0 x 25 mm	5
18761	PH1 x 25 mm	5
18762	PH2 x 25 mm	5
18763	PH3 x 25 mm	5
18764	PH4 x 25 mm	1



BIT PZ

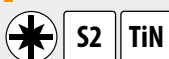

No.	specification	
18765	PZ0 x 25 mm	5
18766	PZ1 x 25 mm	5
18767	PZ2 x 25 mm	5
18768	PZ3 x 25 mm	5
18769	PZ4 x 25 mm	5



BIT S

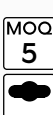
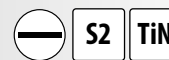

No.	specification	
18750	S 3 x 25 mm	5
18751	S 4 x 25 mm	5
18753	S 5 x 25 mm	5
18755	S 6 x 25 mm	5



BIT H



MOQ 5

No.	specification	
18800	H 1,5 x 25 mm	5
18801	H 2,0 x 25 mm	5
18802	H 2,5 x 25 mm	5
18803	H 3,0 x 25 mm	5
18804	H 4,0 x 25 mm	5
18805	H 5,0 x 25 mm	5
18806	H 5,5 x 25 mm	5
18807	H 6,0 x 25 mm	5



BIT TTA



MOQ 5

No.	specification	
18835	TTa 5 x 25 mm	10
18836	TTa 6 x 25 mm	5
18837	TTa 7 x 25 mm	5
18838	TTa 8 x 25 mm	5
18839	TTa 9 x 25 mm	5
18840	TTa 10 x 25 mm	5
18841	TTa 15 x 25 mm	5
18842	TTa 20 x 25 mm	5
18843	TTa 25 x 25 mm	5
18844	TTa 27 x 25 mm	5
18845	TTa 30 x 25 mm	5
18846	TTa 40 x 25 mm	5
18847	TTa 45 x 25 mm	5



BIT T



MOQ 5

No.	specification	
18820	T5 x 25 mm	5
18821	T6 x 25 mm	5
18822	T7 x 25 mm	5
18823	T8 x 25 mm	5
18824	T9 x 25 mm	5
18825	T10 x 25 mm	5
18826	T15 x 25 mm	5
18827	T20 x 25 mm	5
18828	T25 x 25 mm	5
18829	T27 x 25 mm	5
18830	T30 x 25 mm	5
18831	T40 x 25 mm	5
18832	T45 x 25 mm	5



BIT HTA



MOQ 5

No.	specification	
18810	HTa 1,5 x 25 mm	5
18811	HTa 2,0 x 25 mm	5
18812	HTa 2,5 x 25 mm	5
18813	HTa 3,0 x 25 mm	5
18814	HTa 4,0 x 25 mm	5
18815	HTa 5,0 x 25 mm	5
18816	HTa 5,5 x 25 mm	5
18817	HTa 6,0 x 25 mm	5



BIT SQ



MOQ 5

No.	specification	
18850	SQ 0 x 25 mm	5
18851	SQ 1 x 25 mm	5
18852	SQ 2 x 25 mm	5
18853	SQ 3 x 25 mm	5



BIT T



MOQ 3

Č.p.	specifikace	
17980	T30 x 35 mm	3
17981	T40 x 35 mm	3
17982	T45 x 35 mm	3
17983	T50 x 35 mm	3



BIT SD



MOQ 5

No.	specification	
18855	SD 6 x 25 mm	5
18856	SD 8 x 25 mm	5



BIT T



MOQ 3

No.	specification	
17970	T20 x 75 mm	3
17971	T25 x 75 mm	3
17972	T30 x 75 mm	3
17973	T40 x 75 mm	3

No.	specification	
17974	T45 x 75 mm	3
17975	T50 x 75 mm	3
17976	T55 x 75 mm	3



BIT TS



MOQ 5

No.	specification	
18864	TS 4 x 25 mm	5
18865	TS 6 x 25 mm	5



BIT



MOQ 5

No.	specification	
18866	5/32 x 25 mm	5
18867	3/16 x 25 mm	5



BIT TW



MOQ 5

No.	specification	
18860	TW 1 x 25 mm	5
18861	TW 2 x 25 mm	5
18862	TW 3 x 25 mm	5
18863	TW 4 x 25 mm	5



BIT XZN



MOQ 5

No.	specification	
18870	M4 x 25 mm	5
18871	M5 x 25 mm	5
18872	M6 x 25 mm	5
18873	M8 x 25 mm	5
18874	M10 x 25 mm	5



BIT ADAPTER



MOQ 5

No.	specification	
18868	25 mm	5



BIT ADAPTER

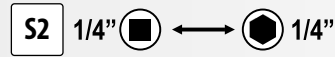

MOQ 5

No.	specification	
18869	50 mm	5



FESTA
INDUSTRY

DRY WALL BIT



No.	specification	
18795	PH 2 x 25 mm	24



FESTA
INDUSTRY

DRY WALL BIT



No.	specification	
18796	PH 2 x 55 mm	24



FESTA
INDUSTRY

ADAPTER
RATCHET 1/4' - BIT

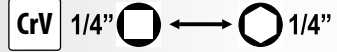

No.	specification	
18619		5

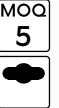

FESTA
INDUSTRY

MAGNETIC BIT HOLDER



No.	specification	
18600	1/4' x 60 mm	5



FESTA
INDUSTRY

MAGNETIC BIT HOLDER



No.	specification	
18601	1/4' x 60 mm	5



FESTA
INDUSTRY

MAGNETIC BIT HOLDER



No.	specification	
18602	1/4' x 60 mm	5



FESTA
INDUSTRY

MAGNETIC BIT HOLDER



No.	specification	
18797	1/4' x 60 mm	1



FESTA
INDUSTRY

MAGNETIC BIT HOLDER



No.	specification	
18798	1/4' x 60 mm	1



FESTA
INDUSTRY

MAGNETIC BIT HOLDER

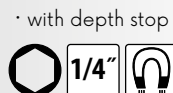

No.	specification	
18799	1/4' x 60 mm	1



FESTA
INDUSTRY

MAGNETIC BIT HOLDER



No.	specification	
18605	150 mm	25



FESTA
INDUSTRY

ADAPTER SDS + FOR BIT 1/4"



No.	specification	
20743	75 mm	1



SLIDING BIT HOLDER



No.	specification	
18607	80 mm	25



FESTA

MAGNETIC BIT HOLDER



No.	Specifications	
18609	90mm	1

NEW

WEST BERG

ADAPTER BIT 1/4" - SDS +

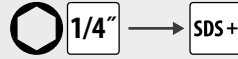

No.	Specifications	
20742		1

NEW

FESTA INDUSTRY

BIT SET AND ADAPTERS

- 10x ⊕ 18630 PH0
- 10x ⊕ 18631 PH1
- 10x ⊕ 18632 PH2
- 10x ⊕ 18633 PH3
- 10x ⊕ 18635 PZ0
- 10x ⊕ 18636 PZ1
- 10x ⊕ 18637 PZ2
- 10x ⊕ 18638 PZ3
- 10x ⊕ 18761 PH1 TiN
- 10x ⊕ 18762 PH2 TiN
- 10x ⊕ 18763 PH3 TiN
- 10x ⊕ 18766 PZ1 TiN
- 10x ⊕ 18767 PZ2 TiN
- 10x ⊕ 18768 PZ3 TiN
- 10x ⊕ 18770 PH1 DIAMANT
- 10x ⊕ 18771 PH2 DIAMANT
- 10x ⊕ 18775 PZ1 DIAMANT
- 10x ⊕ 18776 PZ2 DIAMANT
- 10x ⊙ 18814 4,0HTa
- 10x ⊙ 18815 5,0HTa
- 10x ⊕ 18842 20TTa
- 10x ⊕ 18845 30TTa
- 10x ⊕ 18795 drywall bit
- 5x 18612 adapter 1/4" 8mm
- 5x 18613 adapter 1/4" 10mm
- 5x 18600 magnetic bit holder 1/4" 60mm
- 5x 18601 magnetic quick release bit holder 1/4" 60mm
- 5x 18602 magnetic bit holder - screwcap 1/4" 65mm



No.	specification	
18993		1

FESTA INDUSTRY

BIT SET

- 10x ⊕ 18631 PH1
- 10x ⊕ 18632 PH2
- 10x ⊕ 18633 PH3
- 10x ⊕ 18636 PZ1
- 10x ⊕ 18637 PZ2
- 10x ⊕ 18638 PZ3
- 10x ⊕ 18761 PH1 TiN
- 10x ⊕ 18762 PH2 TiN
- 10x ⊕ 18763 PH3 TiN
- 10x ⊕ 18766 PZ1 TiN
- 10x ⊕ 18767 PZ2 TiN
- 10x ⊕ 18768 PZ3 TiN
- 10x ⊙ 18804 H 4
- 10x ⊙ 18805 H 5
- 10x ⊙ 18825 T 10
- 10x ⊙ 18826 T 15
- 10x ⊙ 18827 T 20
- 10x ⊙ 18828 T 25
- 10x ⊙ 18830 T 30
- 10x ⊙ 18831 T 40

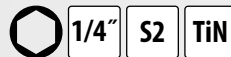

No.	specification	
18994		1

FESTA INDUSTRY

ADAPTER 1/4"

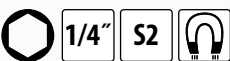

No.	specification	
18610	6 mm	5
18611	7 mm	5
18612	8 mm	5



FESTA INDUSTRY

ADAPTER 1/4"



No.	specification	
18610A	6 mm	5
18611A	7 mm	5
18612A	8 mm	5
18613A	10 mm	5
18614A	12 mm	5
18615A	13 mm	5



FESTA

ADAPTER - SADA



No.	specification	
18618	6, 7, 8, 9, 10, 11, 12, 13 mm	12





FESTA

BIT SET

- bit 25 mm S 3 · 4 · 5 · 6
- PH 0 · 1 · 2 · 3
- PZ 0 · 1 · 2 · 3
- H 3 · 4 · 5 · 6
- T 10 · 15 · 20 · 25 · 27 · 30 · 40
- TTa 10 · 15 · 20 · 25 · 27 · 30 · 40

bit holder

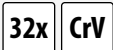

No. specifications
18908



No. specification
18905



FESTA

BIT SET

- S 3 · 4 · 5 · 6
- PH 1 · 2 · 3
- PZ 1 · 2 · 3
- H 3 · 4 · 5 · 6
- T 10 · 15 · 20 · 25 · 27 · 30 · 40
- TTa 10 · 15 · 20 · 25 · 27 · 30 · 40

· magnetic quick release bit holder



FESTA

BIT SET

- S 4 · 5 · 6
- PH 1 · 2 · 3
- PZ 1 · 2 · 3
- H 3 · 4 · 5 · 6
- T 10 · 15 · 20 · 25 · 27 · 30 · 40
- TTa 10 · 15 · 20 · 25 · 27 · 30 · 40

· magnetic quick release bit holder

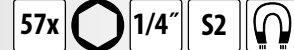

No. specification
18906



No. specification
6

FESTA

BIT SET

- HTa 2 · 2.5 · 3 · 4 · 5 · 6
5/32" · 9/64" · 1/8"
7/64" · 3/32" · 5/64"
- SD 4 · 6 · 8 · 10
- TS 6 · 8 · 10
- TW 1 · 2 · 3 · 4
- TTa 8 · 10 · 15 · 20 · 25 · 27 · 30 · 35 · 40

magnetic bit holder



No. specification
18900



No. specification
10

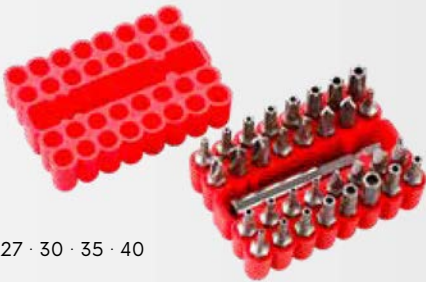

FESTA

BIT SET

- S 3 · 4 · 4.5 · 5 · 5.5 · 6 · 6.5 · 7 · 8
- PH 0 · 1 · 2 · 3
- PZ 0 · 1 · 2 · 3
- Q 0 · 1 · 2 · 3
- T 8 · 10 · 15 · 20 · 25 · 27 · 30 · 40 · 45
- TTa 8 · 10 · 15 · 20 · 25 · 27 · 30 · 35 · 40
- H 1.5 · 2 · 2.5 · 3 · 4 · 5 · 5.5 · 6 · 8 mm
1/16" · 5/64" · 3/32" · 7/64" · 1/8" · 9/64"
5/32" · 3/16" · 7/32" · 1/4"
- HTa 2 · 2.5 · 3 · 4 · 5 · 6 mm
5/64" · 3/32" · 7/64" · 1/8" · 9/64" · 5/32"
- SD 4 · 6 · 8 · 10
- TS 6 · 8 · 10
- TW 1 · 2 · 3 · 4
- 2-wing 1 · 2 · 3
- ZN 5 · 6 · 8

magnetic bit holder

„Y“ holder

1/4" DR screwdriver bit holder

1/4" bit adapter: 25mm, 50mm



No. specification
18909



No. specification
24



FESTA

BIT SET

- S 3 · 4 · 5 · 6 · 7
- PH 0 · 1 · 2 · 3
- PZ 1 · 2 · 3
- H 2 · 2.5 · 3 · 4 · 5 · 6
- T 10 · 15 · 20 · 25 · 30 · 40

magnetic bit holder



No. specification
18901



No. specification
10



BIT SET

- ⊖ S 4 · 5 · 6 · 7
- ⊕ PH 1 · 2 · 3
- ✱ PZ 1 · 2 · 3
- H 4 · 5 · 6
- ⊛ T 10 · 15 · 20 · 25
- SQ 1 · 2 · 3

20x S2



BIT SET

- ⊖ S 4 · 5 · 6 · 7
- ⊕ PH 1 · 2 · 3
- ✱ PZ 1 · 2 · 3

10x CrV TiN

BIT SET

- ⊖ S 3 · 5 · 7
- ⊕ PH 1 · 2 · 3

magnetic bit holder

7x HOBBY



No.	specification	10
18907		

No.	specification	10
18440		

No.	specification	20
18430		



BIT SET

- ⊖ S 3 · 3,5 · 4 · 5,5
- ⊕ PH 0 · 1 · 2 · 3
- ✱ PZ 0 · 1 · 2 · 3
- H 3 · 4
- ⊛ T 10 · 15 · 20 · 25 · 27 · 30
- 1/4" 4 · 4,5 · 5 · 5,5 · 6 · 7 · 8 · 9 · 10 · 11 · 13

screwdriver holder 1/4"
magnetic bit holder

CrV 1/4"

40x



No.	specification	10
18915		

SET OF TOOLS

- ⊖ S 5 · 6 mm
- ⊕ PH 1 · 2
- H 3 · 4 · 5 · 6
- ⊛ T 15 · 20 · 25 · 30
- 1/4" 4 · 5 · 6 · 7 · 8 · 9 · 10 · 12 · 13 mm

75 mm 1/4"
1/4" 1/4"

1/4" CrV

23x



No.	specification	10
18421		



- 1/2", 1/4"
- 1/4" · 4-5-6-7-8-9mm
- 1/2" · 10-12-13-14-17-19mm
- 1/4" · 4-4.5-5-5.5-6-7-8-9-10-11-12-13-14mm
- 1/2" · 12-13-14-15-16-17-18-19-20-21-22-24mm
- 1/2", 1/4"
- 1/4" 1/4"
- 1/4" · 150mm
- 1/2" · 254mm
- 1/2", 1/4"
- 1/2" · 16-21mm
- 1/4" · 150mm
- 1/2" · E10-E12-E14-E16-E18-E20-E22-E24
- 1/4" S 3 · 4 · 5 · 6
- 1/4" PH 0 · 1 · 2
- 1/4" PZ 0 · 1 · 2
- 1/4"
- 1/4" · S 4 · 5,5 · 6,5
- 1/4" PH 1 · 2 · 3
- 1/4" PZ 2 · 3
- 1/4" H 3 · 4 · 5 · 6
- 1/4" T 8 · 10 · 15 · 20 · 25
- 1/4" TTa 10 · 15 · 20 · 25 · 40
- 2 · 2,5 · 3 · 4 · 5 · 6 · 7 · 8 · 10mm
- 8-9-10-11-12-13-14-15-16-17-18-19mm
- S 4x100 · 6,5x150
- PH 2x100 · 3x150
- 180mm
- 160mm
- 160mm
- 250mm
- 300g

FESTA

SET OF TOOLS

122x CrV S2 1/4" 1/2" 72T

No.	specification	
17238	122 pcs	1



SET OF TOOLS

- 160 mm
- 160 mm
- 300 g
- 1/4" 45T
- 4 · 5 · 6 · 7 · 8 · 9 · 10 · 11 · 12 · 13 mm
- 1/4" 75 mm
- 1,5 · 2 · 2,5 · 3 · 4 · 5 · 6 · 8 · 10 mm
- S 3 · 4 · 5 · 6 mm
- PH 0 · 1 · 2 · 3
- PZ 0 · 1 · 2 · 3
- T 10 · 15 · 20 · 25
- H 3 · 4 · 5 · 6
- S 5x100 mm
- PH 1x100 · 2x100 mm
- S 2,5x50 mm
- PH 00x50 · 0x50 mm
- AC 100-250 V
- 200 mm max. 22 mm
- 10x11 · 12x13 · 14x15 · 16x17 mm
- 18 mm
- 2 mm 13 mm

SET OF TOOLS

- 120mm
- 125mm
- 115mm
- 150mm max. 19mm
- 9mm
-
-
- 1/4" 160mm
- 5 · 6 · 7 · 8 · 9 · 10 · 11 mm
- 1/4"
- 1/4"
- S 4 · 6 mm
- PH 1 · 2 · 3
- PZ 1 · 2
- H 4 · 5 · 6

SET OF TOOLS

- 1/4" 5 · 6 · 7 · 8 · 9 · 10 · 11 · 12 mm
- 1/4"
- 1/4"
- AC 230 V
- PH 0, SL 3
- 9x 1,5-10 mm
- 160 mm
- S 3 · 4 · 5 · 6 mm
- PH 0 · 1 · 2 · 3
- H 4 · 5
- PH 2x100, S 6x100
- 18 mm
- 1 m
- 300 g

60x

No.	specification	
17259		5

35x

No.	specification	
17260		10

39x

No.	specification	
17247		10

FESTA

10 years
guarantee



Cr-Mo

- for use in industry and services
- high quality Chrom Vanadium steel
- ratchet with 72 teeth for the most precise work
- all components by DIN norm
- knurled heads for better grip
- strong case with steel lockers and steel hinges



FESTA

SOCKET SET

- 1/2", 1/4", 3/8"
- 1/4" · 4-5-6-7-8-9-10mm
- 3/8" · 10-11-12-13-14-15mm
- 1/2" · 16-17-18-19-22mm
- 1/4" · 4-4.5-5-5.5-6-7-8-9-10-11-12-13-14mm
- 3/8" · 10-11-12-13-14-15-16-17-18-19mm
- 1/2" · 10-11-12-13-14-15-16-17-18-19-20-21-22-24-27-30-32mm
- 1/4" · E4-E5-E6-E7-E8
- 3/8" · E10-E11-E12-E14-E16-E18
- 1/2" · E20-E24
- 1/2" · 24x
- 1/4" · 20x
- 1/4" · 30x
- 1/4" · 50 mm, 100 mm
- 1/2" · 125 mm, 250 mm
- 3/8" · 150 mm
- 1/2" · 16-21mm
- 3/8" · 18mm
- 1/2", 1/4", 3/8" bit holder
- 1/2", 1/4", 3/8"
- 1/4" · 150mm
- 1/4" · 115mm
- Inbus 7X



10 years
guarantee



CrV S2 1/4" 1/2" 3/8" 72T 171x ERGO HANDLE

No. specification
17237 2



FESTA

SOCKET SET

- 1/2" · 72T
- 1/2" · 125 mm
- 1/2" · 10-11-12-13-14-15-17-19-22-24 mm



CrV 1/2" 72T 12x ERGO HANDLE

Č.p. specifikace 17245 15



FESTA

SOCKET SET

- 1/2" · 72T
- 1/2" · 125 mm
- 1/2" · 10-11-12-13-14-15-17-19-22-24 mm



CrV 1/2" 72T 12x ERGO HANDLE

Č.p. specifikace 17229 8



FESTA

SOCKET SET

- 1/2" · 72 T
- 1/2" · 75, 125 mm
- 1/2"
- 1/2" · 10-11-12-13-14-15-16-17-18-19-22-24 mm
- 1/2" · 17mm, 19mm
- 3 way adapter
- 16mm, 21mm



CrV 1/2" 72T 20x ERGO HANDLE

Č.p. specifikace 17230 4



FESTA

SOCKET SET

- 1/4" · 72 T
- 1/4" · 50, 100 mm
- 1/4"
- 1/4" · 4-5-5,5-6-7-8-10-11-12-13 mm
- 1/4" · 6-7-8-10-12-13 mm
- 3 way adapter
- 4 x
- 11x
- 1x



CrV S2 1/4" 72T 36x ERGO HANDLE

Č.p. specifikace 17231 10



FESTA

SOCKET SET

- 1/4"
- 1/4"
- 1/4" · 4-4,5-5-5,5-6-7-8-9-10-11-12-13-14 mm
- 1/4" · 50 mm, 100 mm
- 1/4"
- 1/4"
- 21 x
- 1/4"
- L 1/4"



CrV S2 1/4" 72T 45x ERGO HANDLE

Č.p. specifikace 17233 10



FESTA

SOCKET SET

- 1/2", 1/4" · 72T
- 1/4"
- 16 mm, 21 mm
- 1/4" · 10-11-12-13-14-15-16-17-18-19-20-21-22-23-24-27 mm
- 1/4" · 100 mm
- 1/2" · 125 mm, 250 mm
- 1/2"
- 1 x
- 1/4" · 4-5-5,5-6-7-8-10-11-12-13 mm
- 33 x



CrV S2 1/4" 1/2" 72T 73x ERGO HANDLE

Č.p. specifikace 17234 4

FESTA

SOCKET SET

- 1/2", 1/4" · 72T
- 1/4"
- 16 mm, 21 mm
- 1/4" · 4 -4,5-5-5,5-6-7-8-9-10-11-12-13-14 mm
- 1/2" · 10-11-12-13-14-15-16-17-18-19-20-21-22-23-24-27-30-32 mm
- 1/4" · 6-7-8-9-10-11-12-13 mm
- 1/2" · 14-15-17-19 mm
- 1/4" · 50 mm, 100 mm
- 1/2" · 125 mm, 250 mm
- 1/4"
- 5/16" bit holder
- 17x
- 15x
- 3 way adapter
- 3 x
- 1/4"
- L 1/4"
- 1/2", 1/4"

CrV S2 1/4" 1/2" 72T 94x ERGO HANDLE



Č.p.	specifikace
17235	4

FESTA

SOCKET SET

- 1/2", 1/4" · 72T
- 150 mm
- 16 mm, 21 mm
- 1/4" · 4 -4,5-5-5,5-6-7-8-9-10-11-12-13-14 mm
- 1/2" · 10-11-12-13-14-15-16-17-18-19-20-21-22-24-27-30-32 mm
- 1/4" · 6-7-8-9-10-11-12-13 mm
- 1/2" · 14-15-17-19-22 mm
- 1/4" · 50 mm, 100 mm
- 1/2" · 125 mm, 250 mm
- E · 4-5-6-7-8-10-11-12-14-16-18-20-24-27-30-32 mm
- 1/2", 1/4"
- 5/16" bit holder
- 18 x
- 17 x
- 3 way adapter
- 4 x
- 1/4"
- L 1/4"

CrV S2 1/4" 1/2" 72T 110x ERGO HANDLE



Č.p.	specifikace
17236	4

FESTA

SET OF TOOLS

- 1/2", 1/4"
- 1/4" · 4-5-6-7-8-9mm
- 1/2" · 10-12-13-14-17-19mm
- 1/4" · 4-4,5-5-5,5-6-7-8-9-10-11-12-13-14mm
- 1/2" · 12-13-14-15-16-17-18-19-20-21-22-24mm
- 1/2", 1/4"
- 1/4" · 4-4,5-5-5,5-6-7-8-9-10-11-12-13-14mm
- 1/4" · 12-13-14-15-16-17-18-19-20-21-22-24mm
- 1/4" · 150mm
- 1/2" · 254mm
- 1/2", 1/4"
- 1/2" · 16-21mm
- 1/4" · 150mm
- 1/2" · E10-E12-E14-E16-E18-E20-E22-E24
- 1/4" · S 3 · 4 · 5 · 6
- 1/4" · PH 0 · 1 · 2
- 1/4" · PZ 0 · 1 · 2
- 1/4" · S 4 · 5,5 · 6,5
- 1/4" · PH 1 · 2 · 3
- 1/4" · PZ 2 · 3
- 1/4" · H 3 · 4 · 5 · 6
- 1/4" · T 8 · 10 · 15 · 20 · 25
- 1/4" · TTα 10 · 15 · 20 · 25 · 40
- 2 · 2,5 · 3 · 4 · 5 · 6 · 7 · 8 · 10mm
- 8-9-10-11-12-13-14-15-16-17-18-19mm
- S 4x100 · 6,5x150
- PH 2x100 · 3x150
- 180mm
- 160mm
- 160mm
- 250mm
- 300g

CrV S2 1/4" 1/2" 72T 122x ERGO HANDLE



Č.p.	specifikace
17238	122 ks 1



FESTA



FESTA



Cr-Mo

- ratchet is made from the best quality ChromVanadium steel
- ratchet with 72 teeth for most precise work
- quality ergonomic, two-component handle made of softened TPE rubber
- SYSTEM QUICK RELEASE for quick and easy changing of socket heads



FESTA
RATCHET



Č.p.	specifikace	délka	
17297	1/4"	155 mm	6
17298	3/8"	210 mm	5
17299	1/2"	255 mm	4

FESTA
RATCHET



Č.p.	specifikace	délka	
17240	1/4"	155 mm	10
17241	3/8"	200 mm	10
17242	1/2"	250 mm	5

FESTA
RATCHET



Č.p.	specifikace	délka	
17294	1/4"	155 mm	6
17295	3/8"	205 mm	10
17296	1/2"	255 mm	4

FESTA
REVERSIBLE
RATCHET 1/4"



Č.p.	specifikace	
17292	1/4"	1

RATCHET
HOBBY



Č.p.	specifikace	
17243	1/4" 43T	25
17244	1/2" 39T	25

FESTA
ADAPTER
FOR SOCKETS

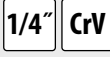

Č.p.	specifikace	
18603	1/4" 150 mm	10



FESTA

SOCKET HEAD 1/4"



Č.p.	specifikace	
17820	4 mm • 25 mm	10
17821	4,5 mm • 25 mm	10
17822	5 mm • 25 mm	10
17823	5,5 mm • 25 mm	10
17824	6 mm • 25 mm	10
17825	7 mm • 25 mm	10
17826	8 mm • 25 mm	10
17827	9 mm • 25 mm	10
17828	10 mm • 25 mm	10
17829	11 mm • 25 mm	10
17830	12 mm • 25 mm	10
17831	13 mm • 25 mm	10
17832	14 mm • 25 mm	10



FESTA

SOCKET HEAD 1/2"

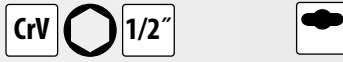

Č.p.	specifikace	
17308	8 mm • 38 mm	10
17309	9 mm • 38 mm	10
17310	10 mm • 38 mm	10
17311	11 mm • 38 mm	10
17312	12 mm • 38 mm	10
17313	13 mm • 38 mm	10
17314	14 mm • 38 mm	10
17315	15 mm • 38 mm	10
17316	16 mm • 38 mm	10
17317	17 mm • 38 mm	10
17318	18 mm • 38 mm	10
17319	19 mm • 38 mm	10
17320	20 mm • 38 mm	10
17321	21 mm • 38 mm	10
17322	22 mm • 38 mm	10
17324	24 mm • 38 mm	10
17327	27 mm • 42 mm	20
17330	30 mm • 42 mm	25
17332	32 mm • 42 mm	20
17333	34 mm • 42 mm	20
17334	36 mm • 42 mm	20



FESTA

SOCKET HEAD 3/4"

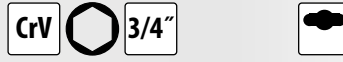

Č.p.	specifikace	
17835	17 mm • 48 mm	10
17836	18 mm • 48 mm	10
17837	19 mm • 48 mm	10
17838	21 mm • 48 mm	10
17839	22 mm • 48 mm	10
17840	24 mm • 48 mm	10
17841	26 mm • 48 mm	10
17842	27 mm • 52 mm	10
17843	28 mm • 52 mm	10
17844	30 mm • 52 mm	10
17845	32 mm • 52 mm	10
17846	33 mm • 55 mm	10
17847	36 mm • 60 mm	10
17848	38 mm • 60 mm	10
17849	41 mm • 65 mm	10
17850	46 mm • 65 mm	10
17851	50 mm • 70 mm	10
17852	55 mm • 75 mm	10
17853	60 mm • 78 mm	10
17854	65 mm • 82 mm	10
17855	70 mm • 82 mm	10
17856	75 mm • 88 mm	10



FESTA

SOCKET HEAD MULTIDRIVE 1/2"

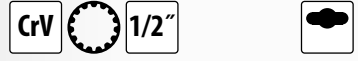

Č.p.	specifikace	
17910	8 mm • 38 mm	10
17914	12 mm • 38 mm	10
17916	14 mm • 38 mm	10
17922	21 mm • 38 mm	10
17924	24 mm • 38 mm	10
17926	30 mm • 38 mm	10



FESTA

SOCKET HEAD DEEP LONG 1/4"



Č.p.	specifikace	
17860	4 mm • 50 mm	10
17861	5 mm • 50 mm	10
17862	6 mm • 50 mm	10
17863	7 mm • 50 mm	10
17864	8 mm • 50 mm	10
17865	9 mm • 50 mm	10
17866	10 mm • 50 mm	10
17867	11 mm • 50 mm	10
17868	12 mm • 50 mm	10
17869	13 mm • 50 mm	10
17870	14 mm • 50 mm	10



FESTA

SOCKET HEAD DEEP (LONG) 1/2"

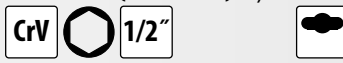

Č.p.	specifikace	
17871	10 mm • 70 mm	10
17872	11 mm • 70 mm	10
17873	12 mm • 70 mm	10
17874	13 mm • 70 mm	10
17875	14 mm • 70 mm	10
17876	15 mm • 70 mm	10
17877	16 mm • 70 mm	10
17878	17 mm • 70 mm	10
17879	18 mm • 70 mm	10
17880	19 mm • 70 mm	10
17881	20 mm • 70 mm	10
17882	21 mm • 70 mm	10
17883	22 mm • 70 mm	10
17884	23 mm • 70 mm	10
17885	24 mm • 70 mm	10
17886	25 mm • 70 mm	10
17887	26 mm • 70 mm	10
17888	27 mm • 70 mm	10
17889	28 mm • 70 mm	10
17890	30 mm • 70 mm	10
17891	32 mm • 70 mm	10
17892	34 mm • 70 mm	10



FESTA

SOCKET HEAD TORX 1/2"

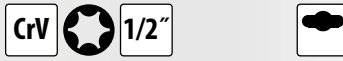

Č.p.	specifikace	
17943	E22	10
17944	E24	10



FESTA

SOCKET HEAD TORX 1/4"

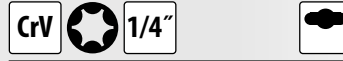

Č.p.	specifikace	
17930	E4	10
17934	E8	10
17935	E10	10



FESTA

SOCKET HEAD MULTIDRIVE 1/4"

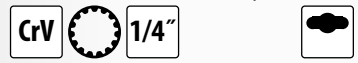

Č.p.	specifikace	
17895	4 mm • 25 mm	10
17896	4,5 mm • 25 mm	10
17897	5 mm • 25 mm	10
17898	5,5 mm • 25 mm	10
17904	11 mm • 25 mm	10
17905	12 mm • 25 mm	10
17907	14 mm • 25 mm	10





FESTA
SLOTTED
SOCKET BIT 1/4"

CrV	S2	1/4"	☁
Č.p.	specifikace		
18920	S 4 mm	10	
18921	S 5,5 mm	10	
18922	S 7 mm	10	



FESTA
PHILIPS
SOCKET BIT 1/4"

CrV	S2	1/4"	☁
Č.p.	specifikace		
18925	PH 1	10	
18926	PH 2	10	
18927	PH 3	10	



FESTA
POZIDRIVE
SOCKET BIT 1/4"

CrV	S2	1/4"	☁
Č.p.	specifikace		
18928	PZ 0	10	
18929	PZ 1	10	
18930	PZ 2	10	
18931	PZ 3	10	



FESTA
TORX
SOCKET BIT 1/2"

CrV	S2	1/2"	☁
Č.p.	specifikace		
18954	T 10	10	
18955	T 15	10	
18956	T 20	10	
18960	T 40	10	
18961	T 45	10	
18963	T 55	10	



FESTA
TORX
SOCKET BIT 1/4"

CrV	S2	1/4"	☁
Č.p.	specifikace		
18948	T 5	10	
18950	T 8	10	
18951	T 10	10	



FESTA
HEX
SOCKET BIT 1/4"

CrV	S2	1/4"	☁
Č.p.	specifikace		
18934	3 mm	10	
18939	8 mm	10	



FESTA
XZN
SOCKET BIT 1/2"

CrV	S2	1/2"	☁
Č.p.	specifikace		
18971	M 16	10	



FESTA
T-M HEAD FOR
SLIDING BAR

CrV	☁	
Č.p.	specifikace	
17420	1/4"	1
17421	1/2"	1
17422	3/4"	1



FESTA
ADAPTER

CrV	☁	
Č.p.	specifikace	
17410	A - 1/4" B - 3/8"	10
17411	A - 3/8" B - 1/4"	10
17412	A - 3/8" B - 1/2"	10
17413	A - 1/2" B - 3/8"	10
17414	A - 1/2" B - 3/4"	10
17415	A - 3/4" B - 1/2"	10
17416	A - 1/4" B - 1/2"	10



FESTA
EXTENSION BAR

CrV	☁	
Č.p.	specifikace	
17390	1/4" • 50 mm	1
17391	1/4" • 100 mm	1
17392	1/4" • 150 mm	1
17393	1/2" • 75 mm	1
17394	1/2" • 125 mm	1
17395	1/2" • 250 mm	1
17396	3/4" • 100 mm	1
17397	3/4" • 200 mm	1
17398	3/4" • 400 mm	1



FESTA
UNIVERSAL JOIN

CrV	☁	
Č.p.	specifikace	
17405	1/4" • 39 mm	10
17406	1/2" • 71 mm	10
17407	3/4" • 105 mm	10

FESTA
SLIDING „T“ BAR

CrV	☁	
Č.p.	specifikace	
17382	1/4" • 115 mm	1
17383	3/8" • 190 mm	1
17384	1/2" • 250 mm	1
17385	3/4" • 460 mm	1
17386	1" • 640 mm	1



FESTA
EXTENSION
WRENCH
WITH SOCKET

CrV	☁	
Č.p.	specifikace	
17401	1/4" • 250 mm	1
17402	1/2" • 400 mm	1





FESTA
SWIVEL HANDLE

No.	specification	
17380	1/2" • 350 mm	1
17381	3/4" • 500 mm	1



FESTA
L HANDLE

No.	specification	
17427	1/2" • 60 x 320 mm	1



FESTA
FLEXIBLE EXTENSION BAR

No.	specification	
17400	1/4" • 150 mm	1

Stahlberg
ADAPTER
RATCHET 1/4" - BIT

No.	specification	
18619	1/4" ↔ 1/4"	5



UNIVERSAL
SOCKET HEAD

No.	Specification	
17812	10 - 19 mm	1



UNIVERSAL SOCKET HEAD

No.	specification	
17810	for screws 7 - 19mm • 52mm x ø26mm	1



UNIVERSAL SOCKET HEAD

No.	specification	
17811	for screws 11 - 32mm • 83mm x ø43mm	5



SOCKET HEAD SET DRIVELOCK

No.	specification	
17250	4-5-5.5-6-7-8-9-10-11-12-13 mm	10



SOCKET HEAD SET TORX

No.	specification	
17255	1/4" • 5-6-7-8-10 1/2" • 12-14-16-18	4

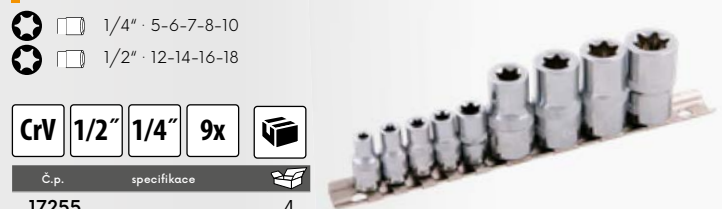

SET OF ADAPTERS

No.	specification	
18604	1/4", 3/8", 1/2"	10



UNIVERSAL
SPUD WRENCH

No.	specification	
17455	for ratchet 1/2"	10

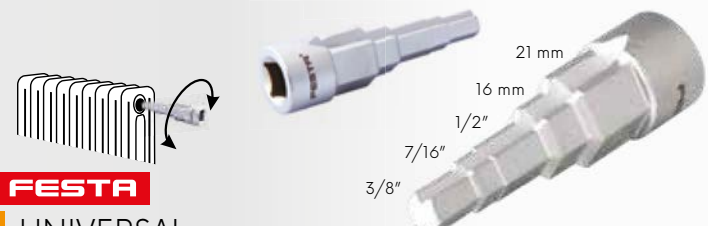

NEW



FESTA

**T HANDLE KEY SET
HEX + TORX**

- H 2.5 · 3 · 4 · 5 · 6 · 8 · 10 mm
- ★ T 10 · 15 · 20 · 25 · 30 · 40 · 45

14x CrV



No.	Specifications	
18501		1

FESTA

**T HANDLE INBUS
KEY HEXAGONAL
SET**

- 2 mm
- 2,5 mm
- 3 mm
- 4 mm
- 5 mm
- 6 mm
- 7 mm
- 8 mm
- 10 mm

9x **CrV**



No.	specification	
18494		6

FESTA

T HANDLE KEY TORX

★ CrV



No.	specification		No.	specification	
17350	T 7	10	17357	T 27	10
17351	T 8	10	17359	T 40	10
17352	T 9	10	17361	T 50	10
17353	T 10	10			

FESTA

**T HANDLE
KEY TORX
SET**

- T 10
- T 15
- T 20
- T 25
- T 27
- T 30
- T 40
- T 45
- T 50

9x **★ CrV**



No.	specification	
18495		6

FESTA

HEX KEY

DIN 911 **CrV**



Č.p.	specifikace	
18567	27 mm 100 x 250 mm	1
18572	32 mm 125 x 315 mm	1

FESTA

HEX KEY - LONG

CrV

Č.p.	specifikace	
18510	1,5 mm 14 x 74 mm	1
18511	2 mm 16 x 81 mm	1
18512	2,5 mm 18 x 88 mm	1
18513	3 mm 23 x 108 mm	1
18514	4 mm 24 x 107 mm	1
18515	5 mm 23 x 118 mm	1
18516	6 mm 32 x 135 mm	1
18518	8 mm 36 x 153 mm	1
18519	9 mm 38 x 155 mm	1
18520	10 mm 40 x 168 mm	1
18521	11 mm 40 x 230 mm	1
18522	12 mm 45 x 237 mm	1
18523	13 mm 45 x 260 mm	1
18524	14 mm 55 x 265 mm	1
18527	17 mm 60 x 298 mm	1

FESTA

HEAD HEX KEY - LONG

CrV

Č.p.	specifikace	
18575	1,5 mm 15 x 75 mm	1
18576	2 mm 17 x 81 mm	1
18577	2,5 mm 18 x 87 mm	1
18578	3 mm 20 x 96 mm	1
18579	4 mm 24 x 107 mm	1
18580	5 mm 30 x 120 mm	1
18581	6 mm 33 x 136 mm	1
18582	7 mm 34 x 144 mm	1
18583	8 mm 36 x 153 mm	1
18584	9 mm 38 x 155 mm	1
18585	10 mm 40 x 168 mm	1
18587	12 mm 45 x 237 mm	1
18588	13 mm 45 x 210 mm	1
18589	14 mm 55 x 265 mm	1
18593	17 mm 60 x 298 mm	1

FESTA

TORX KEY

★ CrV



Č.p.	specifikace	
18476	T45	1

FESTA

HEX KEY SET

- H 1,5 mm
- H 2 mm
- H 2,5 mm
- H 3 mm
- H 4 mm
- H 5 mm
- H 6 mm
- H 8 mm
- H 10 mm

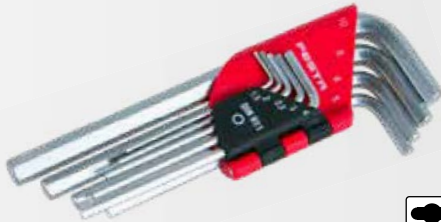

No.	specification	
18496		5

FESTA

HEAD HEX KEY SET

- H 1,5 mm
- H 2 mm
- H 2,5 mm
- H 3 mm
- H 4 mm
- H 5 mm
- H 6 mm
- H 8 mm
- H 10 mm



No.	specification	
18500		5

FESTA

HEX KEY SET - LONG

- H 1,5 mm
- H 2 mm
- H 2,5 mm
- H 3 mm
- H 4 mm
- H 5 mm
- H 6 mm
- H 8 mm
- H 10 mm



No.	specification	
18490		5

FESTA

HEAD HEX KEY SET

- H 1,5 mm
- H 2 mm
- H 2,5 mm
- H 3 mm
- H 4 mm
- H 5 mm
- H 6 mm
- H 8 mm
- H 10 mm



No.	specification	
18498		5

FESTA

HEAD HEX KEY SET

- 1/16"
- 5/64"
- 3/32"
- 1/8"
- 5/32"
- 3/16"
- 1/4"
- 5/16"
- 3/8"

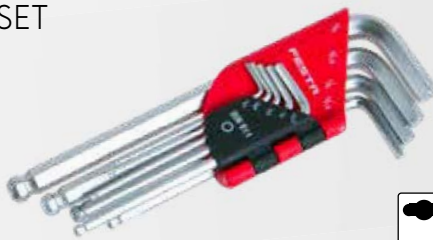

No.	specification	
18493		6

FESTA

TORX SET

- T 10 mm
- T 15 mm
- T 20 mm
- T 25 mm
- T 27 mm
- T 30 mm
- T 40 mm
- T 45 mm
- T 50 mm



No.	specification	
18497		5

FESTA

HEAD HEX KEY SET - LONG

- H 1,5 mm
- H 2 mm
- H 2,5 mm
- H 3 mm
- H 4 mm
- H 5 mm
- H 6 mm
- H 8 mm
- H 10 mm



No.	specification	
18492		10

FESTA

TORX SET - LONG

- T 10 mm
- T 15 mm
- T 20 mm
- T 25 mm
- T 27 mm
- T 30 mm
- T 40 mm
- T 45 mm
- T 50 mm



No.	specification	
18491		5

FESTA

HEX KEY SET



No.	specification	
18508	1,5 · 2 · 2,5 · 3 · 4 · 5 · 6 mm	1



HEX KEY SET

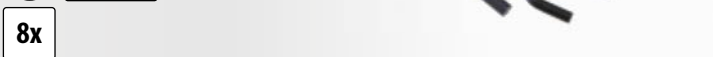

No.	specification	
18499	2 · 2,5 · 3 · 4 · 5 · 6 · 8 · 10 mm	1

FESTA

DOUBLEOPEN SPANNER

CrV DIN 3110



No.	specification	
17550	6 x 7 mm	10
17551	8 x 9 mm	10
17552	8 x 10 mm	10
17553	10 x 11 mm	10
17590	10 x 13 mm	10
17554	12 x 13 mm	10
17555	14 x 15 mm	10
17556	13 x 16 mm	10
17557	13 x 17 mm	10
17591	14 x 17 mm	10
17558	16 x 17 mm	10
17559	17 x 19 mm	10
17560	18 x 19 mm	10

No.	specification	
17592	19 x 22 mm	10
17593	19 x 24 mm	10
17561	20 x 22 mm	10
17569	21 x 23 mm	10
17548	22 x 24 mm	10
17562	24 x 27 mm	10
17549	24 x 30 mm	10
17563	30 x 32 mm	10
17564	30 x 34 mm	10
17565	32 x 36 mm	10
17566	36 x 41 mm	10
17567	46 x 50 mm	10
17568	50 x 55 mm	3

FESTA

COMBINATION SPANNER

CrV DIN 3113



No.	specification	
17487	6 mm	10
17570	7 mm	10
17571	8 mm	10
17572	9 mm	10
17573	10 mm	10
17574	11 mm	10
17575	12 mm	10
17576	13 mm	10
17577	14 mm	10
17578	15 mm	10
17579	16 mm	10
17580	17 mm	10
17581	18 mm	10
17582	19 mm	10
17488	20 mm	10

No.	specification	
17489	21 mm	10
17583	22 mm	10
17490	23 mm	10
17584	24 mm	10
17491	25 mm	10
17492	26 mm	10
17585	27 mm	10
17493	28 mm	10
17494	29 mm	10
17586	30 mm	10
17587	32 mm	10
17495	33 mm	10
17496	34 mm	10
17589	36 mm	10

FESTA

RATCHET SWIVEL SPANNER

CrV 72T



No.	specification	
17628	8 mm	10
17622	10 mm	10
17623	13 mm	10
17624	14 mm	10
17629	15 mm	10
17630	16 mm	5

No.	specification	
17625	17 mm	10
17631	18 mm	10
17626	19 mm	10
17632	21 mm	5
17633	22 mm	5

FESTA

RATCHET SPANNER

CrV 72T



No.	specification	
17660	6 mm	10
17676	7 mm	10
17661	8 mm	10
17662	9 mm	10
17663	10 mm	10
17664	11 mm	10
17665	12 mm	10
17666	13 mm	10
17667	14 mm	10
17668	15 mm	10

No.	specification	
17669	16 mm	10
17670	17 mm	10
17671	18 mm	10
17672	19 mm	10
17674	21 mm	5
17675	22 mm	5
17677	24 mm	5
17678	27 mm	5
17679	30 mm	5
17683	32 mm	5

FESTA

DOUBLEOPEN SPANNER

DIN 895



No.	specification	
17460	6 x 7 mm	10
17461	8 x 9 mm	10
17462	8 x 10 mm	10
17463	10 x 11 mm	10
17481	10 x 13 mm	10
17464	12 x 13 mm	10
17465	14 x 15 mm	10
17467	13 x 17 mm	10
17482	14 x 17 mm	10
17468	16 x 17 mm	10

No.	specification	
17469	17 x 19 mm	10
17470	18 x 19 mm	10
17483	19 x 22 mm	10
17484	19 x 24 mm	10
17471	20 x 22 mm	10
17472	24 x 27 mm	10
17486	21 x 23 mm	10
17480	28 x 30 mm	10
17473	30 x 32 mm	10
17485	36 x 41 mm	10

FESTA

RING SPANNER

CrV DIN 838



No.	specification	
17605	6 x 7 mm	10
17606	8 x 9 mm	10
17607	8 x 10 mm	10
17608	10 x 11 mm	10
17609	12 x 13 mm	10
17611	13 x 16 mm	10
17612	13 x 17 mm	10

No.	specification	
17610	14 x 15 mm	10
17613	16 x 17 mm	10
17614	18 x 19 mm	10
17615	20 x 22 mm	10
17616	24 x 27 mm	10
17617	30 x 32 mm	10

FESTA

DOUBLEOPEN SPANNER

CrV DIN 3110



No.	specification	
17761	14 x 15 mm	10
17769	20 x 22 mm	10

FESTA

COMBINATION SPANNER

CrV DIN 3113



No.	specification	
17788	14 mm	10
17795	21 mm	10
17806	33 mm	10

FESTA

RATCHET WRENCH SET

8-9-10-11-12-13-14-15-16-17-18-19 mm



No.	Specifications	
17619		1



NEW

FESTA

SOCKET WRENCH

Cr-Mo



12-13-14-15 mm

16-17-18-19 mm

No.	specification	
17685	12-13-14-15-16-17-18-19 mm	1



FESTA

ADJUSTABLE WRENCH

CrV



No.	range	length	
17197	0 - 29 mm	200 mm	1
17198	0 - 33 mm	250 mm	1
17199	0 - 38 mm	300 mm	1



ADJUSTABLE WRENCH

No.	range	length	
17200	0 - 24 mm	200 mm	6
17201	0 - 30 mm	250 mm	6
17202	0 - 34 mm	300 mm	6



FESTA



FESTA

OPEN - END WRENCH SET

CrV

DIN 3110



No.	specification	
17506	6 pcs · 6 x 7, 8 x 9, 10 x 11, 12 x 13, 14 x 15, 16 x 17	1
17508	8 pcs · 6 x 7, 8 x 9, 10 x 11, 12 x 13, 14 x 15, 16 x 17, 18 x 19, 20 x 22	1



FESTA

COMBINATION SPANNER SET

CrV

DIN 3113



No.	specification	
17526	6 pcs · 10 x 10, 11 x 11, 13 x 13, 14 x 14, 16 x 16, 17 x 17	1
17528	8 pcs · 8 x 8, 10 x 10, 11 x 11, 13 x 13, 14 x 14, 16 x 16, 17 x 17, 19 x 19	1



FESTA

RINGSPANNER SET

8x

CrV

DIN 838



No.	specification	
17539	6 x 7, 8 x 9, 10 x 11, 12 x 13, 14 x 15, 16 x 17, 18 x 19, 20 x 22	1



FESTA

COMBINATION SPANNER SETS

CrV

DIN 3113



No.	specification	
17532	12 pcs · 8 x 8, 9 x 9, 10 x 10, 11 x 11, 13 x 13, 14 x 14, 16 x 16, 17 x 17, 18 x 18, 19 x 19, 21 x 21, 22 x 22	10
17533	18 pcs · 6 x 6, 7 x 7, 8 x 8, 9 x 9, 10 x 10, 11 x 11, 12 x 12, 13 x 13, 14 x 14, 15 x 15, 16 x 16, 17 x 17, 18 x 18, 19 x 19, 20 x 20, 21 x 21, 22 x 22, 24 x 24	1
17534	25 pcs · 6 x 6, 7 x 7, 8 x 8, 9 x 9, 10 x 10, 11 x 11, 12 x 12, 13 x 13, 14 x 14, 15 x 15, 16 x 16, 17 x 17, 18 x 18, 19 x 19, 20 x 20, 21 x 21, 22 x 22, 23 x 23, 24 x 24, 25 x 25, 26 x 26, 27 x 27, 28 x 28, 30 x 30, 32 x 32	4

FESTA

OPEN - END WRENCH SETS

CrV

DIN 3110

12x



No.	specification	
17512	6 x 7, 8 x 9, 10 x 11, 12 x 13, 14 x 15, 16 x 17, 18 x 19, 20 x 22, 21 x 23, 24 x 27, 25 x 28, 30 x 32	1

FESTA

OPEN END SPANNER SETS DIN 895

DIN 895



No.	specification	
17475	8 pcs · 6 x 7, 8 x 9, 10 x 11, 12 x 13, 14 x 15, 16 x 17, 18 x 19, 20 x 22	5
17476	12 pcs · 6 x 7, 8 x 9, 10 x 11, 12 x 13, 14 x 15, 16 x 17, 18 x 19, 20 x 22, 21 x 23, 24 x 27, 28 x 30, 30 x 32	3

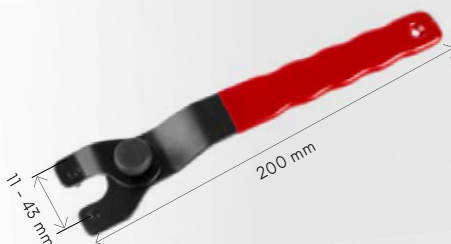

KEY FOR ANGLE GRINDER ADJUSTABLE



No.	specification	
20967	200 mm	15

FESTA

RATCHET SPANNER SET

CrV

72T

7x



No.	specification	
17620	8, 10, 12, 13, 14, 17, 19	5

FESTA

RATCHET SWIVEL SPANNER SET

CrV

72T

7x



No.	specification	
17621	10, 12, 13, 14, 15, 17, 19	5

FESTA

TUBULAR SPANNER SET

CrV

7x



No.	specification	
17501	6 x 7, 8 x 9, 10 x 11, 12 x 13, 14 x 15, 16 x 17, 18 x 19	20
17640	tommy bar · 135 mm	50

FESTA

TUBULAR SPANNER

CrV



No.	specification		No.	specification	
17650	6 x 7 mm	10	17655	16 x 17 mm	10
17651	8 x 9 mm	10	17645	16 x 18 mm	10
17642	8 x 10 mm	10	17653	16 x 21 mm	10
17652	10 x 11 mm	10	17656	18 x 19 mm	10
17643	12 x 13 mm	10	17657	19 x 22 mm	10
17654	14 x 15 mm	10	17659	22 x 24 mm	10
17644	14 x 17 mm	10	17658	24 x 27 mm	10



WRENCH FOR ANGLE GRINDER



No.	specification	
20968	200 mm	1

FESTA

SCAFFOLDING
WRENCH



No.	Specifications	
17452	19 x 22 mm	1



FESTA

SCAFFOLDING
RATCHET

No.	specification	
17451	18 mm	10
17450	19 mm	10



FESTA

TORQUE WRENCH

No.	specification	
17203	1/4" 5 - 25 Nm	1
17204	1/2" 19 - 110 Nm	1
17205	1/2" 42 - 210 Nm	1
17206	3/4" 140 - 700 Nm	1



FESTA

made by **HENLON**
SET OF SOCKET

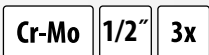

Č.p.	specifikace	
17338	21 mm	5



WHEEL SPANNER,
CROSS



No.	specification	
17600	17, 19, 22 mm, 13/16"	16

WHEEL SPANNER,
CROSS



No.	specification	
17601	17, 19, 21 mm	20

TELESCOPIC
WHEEL
SPANNER



No.	specification	
17603	17 x 19 mm, 21 x 23 mm	20

SOCKET
WRENCH
WITH JOINT



No.	specification	
17261	16 mm	1
17262	21 mm	1

FESTA

HOOK SPANNER

CrV



No.	specification		
17680	19 - 51 mm	165 mm	5
17681	32 - 76 mm	216 mm	5
17682	51 - 121 mm	267 mm	5

TWO LEGS PULLER



No.	max. průměr	depth	
23734	Ø 100 mm	50-95 mm	1
23735	Ø 150 mm	100-150 mm	1
23736	Ø 200 mm	110-190 mm	1

THREE - LEG PULLER



No.	max. diameter	depth	
23730	Ø 100 mm	50-95 mm	2
23731	Ø 150 mm	100-150 mm	2
23732	Ø 200 mm	110-190 mm	2

FESTA

UNIVERSAL SPUD WRENCH

CrV 1/2"

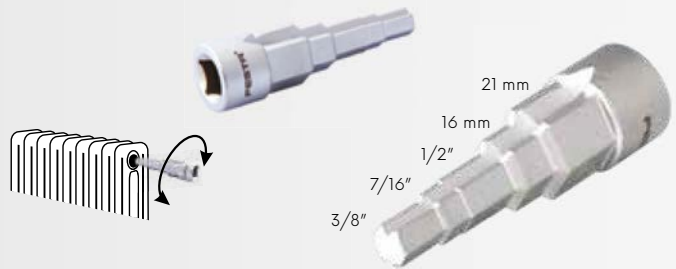

No.	specification	
17455	for ratchet 1/2"	10



RADIATOR BLEED KEY

2x



No.	specifications	
17454	5 x 5 mm	1



RADIATOR BLEED KEY WITH WATER TANK



No.	specification	
17459	50 ml	1



FESTA

UNIVERSAL KEY FOR SWITCH CABINET

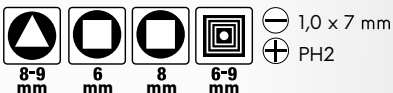

No.	Specification	
17458		1



FESTA

UNIVERSAL KEY FOR SWITCH CABINET

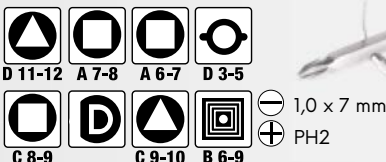

No.	specification	
17456		50





ERGONOMIC handle

STANDARD +30% FESTA

CrV · chrom vanadium steel

HRC 58-62 · jaw hardness

ergonomically hardened

ergonomic handle made of TPE rubber



COMBINATION PLIERS

DIN 5746	TUV GS	No.	specification	Icon
CrV	HRC 58-62	17101	160 mm	6
		17102	180 mm	6
		17103	200 mm	6



SIDE CUTTING PLIERS

DIN 5749	TUV GS	CrV	HRC 58-62	ERGO HANDLE	No.	specification	Icon
					17148	180 mm	6



SIDE CUTTING PLIERS

DIN 5749	TUV GS	CrV	HRC 58-62	ERGO HANDLE	No.	specification	Icon
					17104	160 mm	6
					17105	180 mm	6



RADIAL PLIERS STRAIGHT

DIN 5745	TUV GS	CrV	HRC 58-62	ERGO HANDLE	No.	specification	Icon
					17140	160 mm	6
					17142	200 mm	6



BENT NOSE PLIERS

DIN 5749	TUV GS	CrV	HRC 58-62	ERGO HANDLE	No.	specification	Icon
					17145	160 mm	6
					17146	200 mm	6



FESTA





FESTA

COMBINATION PLIERS

DIN 5746				
No.	specification			
17001	160 mm	6		
17002	180 mm	6		
17003	200 mm	6		



FESTA

SIDE CUTTING PLIERS

DIN 5749				
No.	specification			
17004	160 mm	6		
17005	180 mm	6		



FESTA

SIDE CUTTING PLIERS

DIN 5749				
No.	specification			
17108	180 mm	6		



FESTA

CUTTING FRONT PLIERS

DIN 5748				
No.	specification			
17110	160 mm	6		



FESTA

RADIAL PLIERS STRAIGHT

DIN 5745				
No.	specification			
17006	160 mm	6		
17011	200 mm	6		



FESTA

PLIERS BENT NOSE

DIN 5745				
No.	specification			
17007	160 mm	6		
17008	200 mm	6		



FESTA

FLAT NOSE PLIERS

DIN 5746				
No.	specification			
17009	160 mm	6		



FESTA

ROUND NOSE PLIERS

DIN 5745			
No.	specification		
17010	160 mm	6	



FESTA

WIRE STRIPER PLIERS

DIN 5744			
No.	specification		
17024	160 mm	6	



COMBINATION PLIERS

DIN 5746		
No.	specification	
17094	160 mm	6
17095	180 mm	6
17096	200 mm	6



SIDE CUTTING PLIERS

DIN 5749		
No.	specification	
17097	160 mm	6
17098	180 mm	6



RADIAL PLIERS STRAIGHT

DIN 5745		
No.	specification	
17099	160 mm	6
17100	200 mm	6



VDE COMBINATION PLIERS

1000 V IEC/EN60900:2004 **DIN 5746** **CrV** **HRC 58-62**

No.	specification	
17125	160 mm	6
17126	180 mm	6
17127	200 mm	6



VDE SIDE CUTTING PLIERS

1000 V IEC/EN60900:2004

DIN 5749 **CrV** **HRC 58-62**

No.	specification	
17128	160 mm	6



VDE CABLE/WIRE CUTTERS

1000 V IEC/EN60900:2004

CrV **HRC 58-62**

No.	specification	
17130	160 mm	6



VDE RADIAL PLIERS STRAIGHT

1000 V IEC/EN60900:2004

DIN 5745 **CrV** **HRC 58-62**

No.	specification	
17133	160 mm	6



VDE BENT NOSE PLIERS

1000 V IEC/EN60900:2004

DIN 5745 **CrV** **HRC 58-62**

No.	specification	
17135	160 mm	6



VDE ROUND NOSE PLIERS

1000 V IEC/EN60900:2004

DIN 5745 **CrV** **HRC 58-62**

No.	specification	
17137	160 mm	6



VDE WIRE STRIPPER

1000 V IEC/EN60900:2004 **CrV** **DIN 5744**

No.	specification	
17138	160 mm	6



ELECTRONICS DIAGONAL CUTTER

max Ø 0,2 - 2,1 mm

CrV

No.	Specification	
17047	140 mm	10



ELECTRONICS DIAGONAL PLIERS

wire stripper - 0,75; 1,0; 1,5; 2,5; 4,0; 6,0mm²

CrV

No.	Specifications	
17087	145 mm	1



WIRE STRIPPER

0,5 - 6 mm²
190 mm

No.	specifications	
17178		1



CABLE STRIPPER AND CUTTER

No.	specification	
17180	Ø 0,75 - 2,5 mm	12



CABLE STRIPPER AND CUTTER

No.	specification	
17181	Ø 0,60 - 2,6 mm	10

NEW



FESTA

UNIVERSAL STRIPPING TOOL

· Ø 0,2-4 mm

No.	Specifications	
16205	125 mm	1



FESTA

UNIVERSAL STRIPPING TOOL

AWG	mm ²
10	6,0
12	4,0
14	2,5
16	1,5
18	1,0
20	0,5

· coaxial cable RG6/59
· low voltage cable Ø 8 - 13 mm

No.	Specification	
16202	125 mm	10



FESTA
INDUSTRY

CRIMPING PLIERS

No.	Specifications	
18445		1

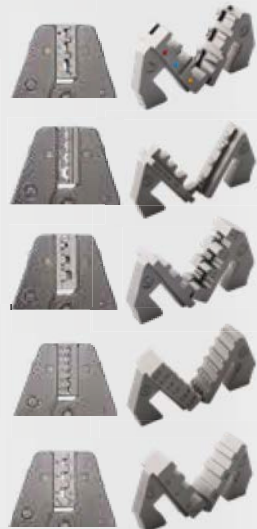

- AWG 22-18/16-14/12-10
· DIN 0,5-1,0/1,5-2,5/4-6mm²
- AWG 20-16/16-14/12-10/8
· DIN 0,5-1,0/1,5-2,5/4-6/10mm²
- AWG 20-18/16-14/12-10
· DIN 0,5-1,0/1,5-2,5/4-6mm²
- AWG 20/18/17/16/14/12
· DIN 0,5/0,75/1,0/1,5/2,5/4,0mm²
- AWG 10/8/6
· DIN 6/10/16mm²

NEW



FESTA
INDUSTRY

MULTI-PURPOSE CRIMPING PLIERS 5in1

No.	Specifications	
16206		1



- AWG 10-22
· 0,5-0,6mm²
- AWG 10-22
· 0,5-0,6mm²
- AWG 10-22
· 0,5-0,6mm²
- AWG 10-24
· 0,2-0,6mm²

· odizolování drátu

NEW



FESTA
INDUSTRY

MULTI-PURPOSE CRIMPING PLIERS 5in1

No.	Specifications	
16208		1



- 1,5; 2,5; 6,0mm²
- 1,5; 2,5; 6,0mm²

- wire stripper · 0,75; 1,0; 1,5; 2,5; 4,0; 6,0mm²
- screw cutting · M2,6; M3; M3,5; M4; M5

NEW



FESTA
MULTIFUNCTION
PLIERS

- 9 functions
- bag

CrV

No.	specification	
16232		12



FESTA
PLIERS SET

4x

No.	specification	
17040		6



FESTA
COMBINATION PLIERS

No.	specification	
17041	110 mm	12



FESTA
SIDE CUTTING PLIERS
MINI

No.	specification	
17042	110 mm	12



FESTA
END CUTTING PLIERS
MINI

No.	specification	
17043	100 mm	12



FESTA
LONG NOSE PLIERS
MINI

No.	specification	
17044	120 mm	12



FESTA
ROUND NOSE PLIERS
MINI

No.	specification	
17045	120 mm	12



FESTA
RING PLIERS

No.	specification	
17025	set	10



FESTA
RING PLIERS

No.	specification	
17190	180 mm inward	6
17191	180 mm outward	6



FESTA
RING PLIERS

No.	specification	
17192	180 mm inward	15
17193	180 mm outward	15



FESTA

**MULTIFUNCTION
FENCE PLIER**

for fence

CrV



No.	specification
17109	270 mm

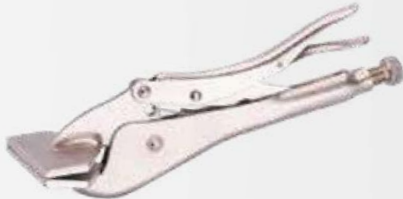

QUICK GRIP WRENCH

Č.p.	specifikace		
17150	220 mm	1	



QUICK GRIP WRENCH

Č.p.	specifikace		
17151	225 mm	1	



QUICK GRIP WRENCH

Č.p.	specifikace		
17034	220 mm	5	



FESTA

QUICK GRIP WRENCH

Č.p.	specifikace		
17036	270 mm	5	



QUICK GRIP WRENCH

Č.p.	specifikace		
17035	220 mm	10	



FESTA

QUICK GRIP WRENCH

Č.p.	specifikace		
17023	220 mm	6	

FESTA

WRENCH 45°, S

CrV



No.	specification	
17067	1" 330 mm	1
17068	1,5" 420 mm	1
17069	2" 540 mm	1



FESTA

ADJUSTABLE WRENCH

CrV

No.	specification	
17063	230 mm	6
17064	300 mm	6

FESTA

PIPE WRENCH 90°

CrV



No.	specification	
17075	1" 330 mm	1
17076	1,5" 420 mm	1
17077	2" 540 mm	1



WRENCH

FESTA

WRENCH 90°

CrV



No.	specification	
17070	2,5" 355 mm	12
17071	3" 455 mm	8
17072	3,5" 610 mm	10



No.	specification	
17065	260 mm	36
17066	300 mm	36

FESTA

WATER PUMP PLIERS



CrV

No.	specifications		
16500	180 mm 0 - 40 mm	1	
16501	250 mm 0 - 52 mm	1	
16502	300 mm 0 - 68 mm	1	

FESTA

WATER PUMP PLIERS



CrV

No.	specification	range of jaw	
17059	180 mm	0 - 30 mm	6
17061	250 mm	0 - 30 mm	6
17062	300 mm	0 - 40 mm	6
17080	400 mm	0 - 84 mm	4

FESTA

WATER PUMP PLIERS



CrV

No.	specification	range of jaw	
17084	250 mm	0 - 30 mm	6

FESTA

WATER PUMP PLIERS



CrV

No.	specification	range of jaw	
17086	250 mm	0 - 50 mm	6

FESTA

WATER PUMP PLIERS



CrV

No.	specification	range of jaw	
17081	180 mm	0 - 30 mm	6
17014	250 mm	0 - 30 mm	6
17082	300 mm	0 - 50 mm	6

FESTA

WATER PUMP PLIERS SELF ADJUSTABLE



CrV

No.	specification	range of jaw	
17079	250 mm	0 - 50 mm	6

FESTA

WATER PUMP PLIERS



CrV

No.	specification	range of jaw	
17012	250 mm	0 - 40 mm	6
17060	300 mm	0 - 50 mm	10

FESTA

WATER PUMP PLIERS



CrV

No.	specification		
17013	250 mm	0 - 30 mm	6
17033	300 mm	0 - 50 mm	6

PLASTIC JAW PROTECTOR FOR PLIERS



• suitable for 17061, 17079, 17086

No.	specification	
17085	1 pair	1

FESTA

CUTTING PLIERS FOR WIRE ROPES



CrV

Č.p.	specifikace	
17029	200 mm	6

FESTA

CUTTING PLIERS



CrV

Č.p.	specifikace	
17039	24' 610 mm	8



FESTA

BOLT CUTTER, FOLDABLE

Cr-Mo



No.	specifications		
17049	18' 450 mm	max. 6 mm < 40 HRC	1

FESTA

BOLT CUTTER PROFESSIONAL

Cr-Mo

HRC 58-62



No.	specification	max. Ø wire	
17051	14' 350 mm	max. 5 mm < 45 HRC	1
17052	18' 450 mm	max. 6 mm < 45 HRC	1
17053	24' 610 mm	max. 8 mm < 45 HRC	1
17054	30' 760 mm	max. 10 mm < 45 HRC	1
17048	36' 900 mm	max. 12 mm < 45 HRC	1



FESTA

BOLT CUTTER PROFESSIONAL

· jaws for cables and wires

Cr-Mo

HRC 58-62



No.	specification	max. Ø wire	max. Ø ACSR cable	max. Ø aircraft kabelu	
17055	14' 360 mm	max. 5 mm < 45 HRC	max. 3,5 mm	max. 8 mm	1
17056	18' 460 mm	max. 6 mm < 45 HRC	max. 5 mm	max. 10 mm	1
17057	24' 610 mm	max. 8 mm < 45 HRC	max. 7 mm	max. 12 mm	1
17058	30' 760 mm	max. 10 mm < 45 HRC	max. 9 mm	max. 14 mm	1
17046	35' 900 mm	max. 12 mm < 45 HRC	max. 10 mm	max. 16 mm	1



FESTA

BOLT CUTTER

Cr-Mo

HRC 57-62

max. Ø 4 mm



No.	specification		
17038	8' 210 mm	max. 4 mm < 30 HRC	10



FESTA

BOLT CUTTER

· soft wire: Ø 6 mm
· medium wire: Ø 5 mm
· hard wire: Ø 4 mm

CrV



No.	Specification		
17078	200 mm		12



BOLT CUTTER



No.	specification	max. Ø wire	
17028	14' 350 mm	max. 5 mm < 30 HRC	30
17020	18' 450 mm	max. 6 mm < 30 HRC	6
17021	24' 610 mm	max. 8 mm < 30 HRC	10
17022	30' 760 mm	max. 10 mm < 30 HRC	5

NEW



FESTA
CUTTING FRONT PLIERS

No.	Specifications	
17172	200 mm	1



FESTA
CARPENTER PINCERS

No.	specification	
17300	160 mm	1
17301	180 mm	10
17302	200 mm	6
17303	250 mm	1



FESTA
RABIT PINCERS

No.	specification	
17305	220 mm	5
17306	250 mm	1
17304	275 mm	6



FESTA
CARPENTER PINCERS

No.	specification	
17015	160 mm	6
17016	180 mm	6
17017	200 mm	6



FESTA
RABIT PINCERS

No.	specification	
17019	220 mm	6
17083	275 mm	6



FESTA
TINSMITH PLIER

No.	specification	
17089	150 x 215 mm	2

NEW



FESTA
TINSMITH PLIERS

No.	Specifications	
17341	24 x 180 mm	1

NEW



FESTA
TINSMITH PLIERS 45°

No.	Specifications	
17342	24 x 180 mm	1



FESTA
TINSMITH PLIER

No.	specification	
17093	95 x 270 mm	6



FESTA
TINSMITH PLIER 45°

No.	specification	
17091	50 x 280 mm	10



FESTA
TINSMITH PLIER 90°

No.	specification	
17092	50 x 260 mm	10



FESTA
TINSMITH PLIER

No.	specification	
17090	50 x 280 mm	10



FESTA
SNIPS

CrV

No.	specification	
17170	50 250 mm	6



SNIPS

CrV

No.	specification	
17167	70 300 mm	5



SNIPS

CrV

No.	specification	
17165	60 250 mm	5



SNIPS

CrV

No.	specification	
17169	35 250 mm	5

FESTA

TINMAN'S SNIPS EXTENDED



Cr-Mo HRC 58-62



No.	specifications	
17113	straight 80 300 mm	6

FESTA

TINMAN'S SNIPS

Cr-Mo HRC 58-62



No.	specification	
17111	straight 40 250 mm	6
17116	right 40 250 mm	6
17121	left 40 250 mm	6

FESTA

TINMAN'S SNIPS PLIERS

Cr-Mo HRC 58-62



No.	specification	
17112	straight 40 260 mm	6
17117	right 40 260 mm	6
17122	left 40 260 mm	6



**METAL NIBBLER
DRILL ATTACHMENT**

Steel	Cu	ALU	
0.8-1mm	1.5mm	1.5mm	
No. specifications			
20364			1

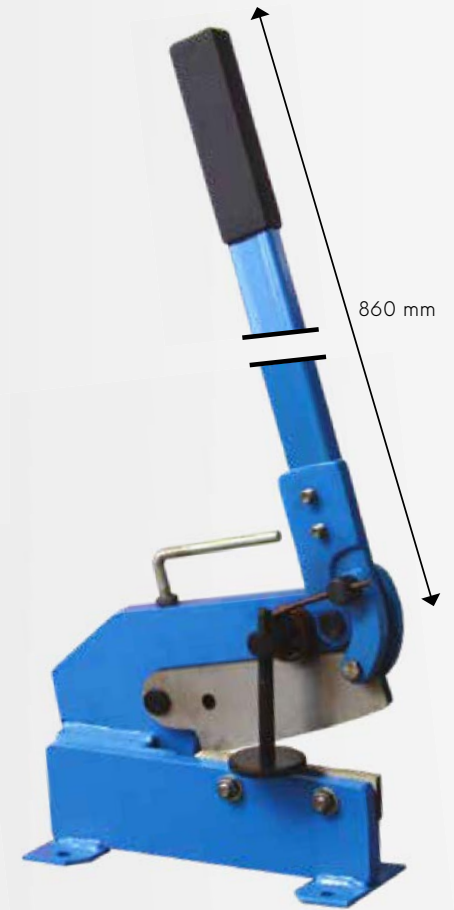

HAND NIBBLER

max 0,8 mm

No.	specification	
17186	265 mm	6



LEVER SHEARS

	17175	17177
	max. 4mm	5mm
	max. \varnothing 10mm	\varnothing 12mm
	max. 8x8mm	10x10mm

No.	specification	
17175	150 mm	1
17177	250 mm	1

**ADAPTER FOR
CUTTING PLATE - NIBBLER**

Max plate thickness:

- 1,8 mm - steel
- 1,2 mm - stainless
- 2 mm - plastic, aluminium, copper

No.	specification	
20363		5

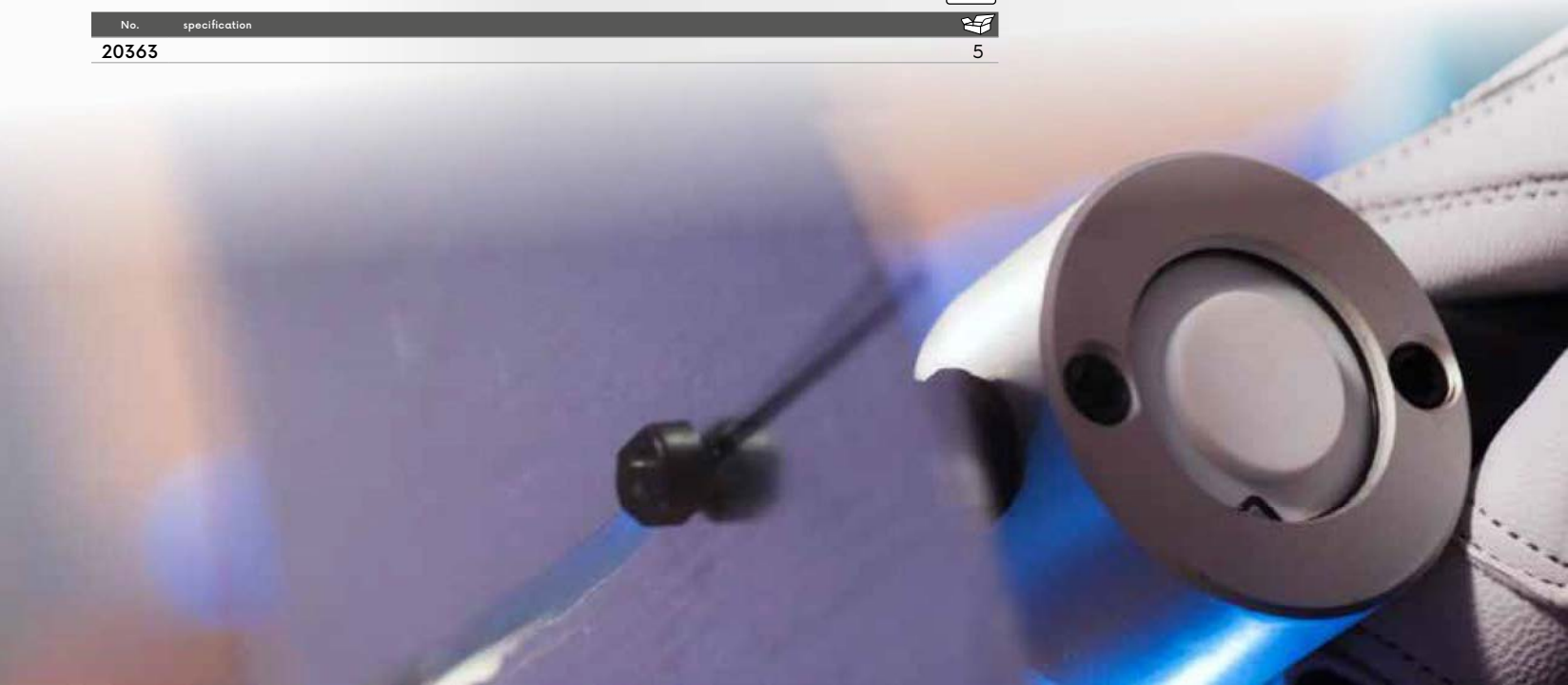



SCISSORS

INOX

PVC



Č.p.	specifikace	
16420	60 200 mm	12



SCISSORS

INOX

PVC



Č.p.	specifikace	
17159	65 220 mm	12



SCISSORS

INOX

PVC



Č.p.	specifikace	
17158	50 150 mm	10



SCISSORS

INOX

PVC



Č.p.	specifikace	
17160	70 210 mm	12



SCISSORS

INOX

Č.p.	specifikace	
16405	14 cm	24
16406	17 cm	24
16407	19 cm	24
16408	21,5 cm	12



SCISSORS SET

3x INOX

Č.p.	specifikace	
16401	3 ks	48



FESTA

PUNCHING TONGS



No.	specification	
17185	Ø 2; 2,5; 3; 3,5; 4; 4,5 mm	12



FESTA

PLIERS FOR THE PROFILE

· Use for: plinths, profiles, tubes



No.	specification	
17050	60 250 mm ø 17 mm, ø 20 mm, ø 27 mm	8



CONNECTING PLIERS FOR PROFILES



No.	specification	
17187	350 mm	6



CONNECTING PLIERS FOR PROFILES



No.	specification	
17188	250 mm	12



RIVETER FOR PLUG



No.	specification	
17189	255 mm	12





FESTA

FESTA
RIVETER

Cr-Mo

- Ø 2,4 mm
- Ø 3,2 mm
- Ø 4,0 mm
- Ø 4,8 mm



No. 24007 specification 200 mm



1



FESTA
RIVETER

Cr-Mo

- Ø 2,4 mm
- Ø 3,2 mm
- Ø 4,0 mm
- Ø 4,8 mm



No. 24010 specification 250 mm



12



FESTA
RIVETER

Cr-Mo

- Ø 2,4 mm
- Ø 3,2 mm
- Ø 4,0 mm
- Ø 4,8 mm
- Ø 6,4 mm



No. 24017 specification 280 mm



1



FESTA
RIVETER

Cr-Mo

- Ø 2,4 mm
- Ø 3,2 mm
- Ø 4,0 mm
- Ø 4,8 mm
- Ø 6,4 mm



No. 24015 specification 530 mm



1



FESTA
RIVETER

Cr-Mo

- Ø 2,4 mm
- Ø 3,2 mm
- Ø 4,0 mm
- Ø 4,8 mm



No. 24030 specification 255 mm



24



FESTA
RIVETER

Cr-Mo



No. 24020 specification 290 mm



8





RIVETER

Cr-Mo

- Ø 2,4 x 6 mm
- Ø 3,2 x 6 mm
- Ø 4,0 x 6 mm
- Ø 4,8 x 6 mm



RIVETER

RIVETER

ALU

No.	specification	
24001	260 mm	6

ALU Cu

No.	specification	
24005	260 mm	5

ALU

No.	specification	
24000	240 mm	24

FESTA

RIVETER ATTACHMENT

- Ø 2,4 mm
- Ø 3,2 mm
- Ø 4,0 mm
- Ø 4,8 mm

INOX ALU Cu

Cr-Mo



No.	specifications	
24008		1

ALU RIVET

ALU

50x

No.	specification	
23970	3,2 x 6 mm	25
23971	3,2 x 8 mm	25
23972	3,2 x 10 mm	25
23973	3,2 x 12 mm	25
23974	3,2 x 14 mm	25
23975	4,0 x 6 mm	25
23976	4,0 x 8 mm	25
23977	4,0 x 10 mm	25
23978	4,0 x 12 mm	25
23979	4,0 x 14 mm	25
23985	4,8 x 6 mm	25
23986	4,8 x 8 mm	25
23987	4,8 x 10 mm	25
23988	4,8 x 12 mm	25
23989	4,8 x 14 mm	25



FESTA

RIVETER

Cr-Mo

- M3
- M4
- M5
- M6
- M8
- M10

INOX ALU Cu



No.	specification	
24036	330 mm	1

FESTA

RIVETER HEAD

· suitable for 24035, 24036

Cr-Mo

No.	specification	
24038	M3	1
24039	M4	1
24040	M5	1
24041	M6	1
24042	M8	1
24043	M10	1



FESTA

RIVETER

Cr-Mo

- M3
- M4
- M5
- M6

INOX ALU Cu



No.	specification	
24035	200 mm	1

NUT RIVETING,

ALU





20x

No.	specification	
23950	M3 x 9 mm	20
23951	M4 x 11 mm	20
23952	M5 x 12 mm	50
23953	M6 x 14 mm	50
23954	M8 x 16,5 mm	25
23955	M10 x 18 mm	20



FESTA

STAPLE GUN 5 IN 1





-  | 6 - 14 mm
23960 - 23964
23760 - 23764,
23906 - 23914
-  | 10 - 14 mm
23965
-  | 15 mm
23966
-  | 15 mm
23967



No.	specification	
23927		6

FESTA

STAPLE GUN 4 IN 1



-  | 6 - 14 mm
23960 - 23964
-  | 12 mm
23965
-  | 14 mm
23966
-  | 14 mm
23967



No.	specification	
23924		12

FESTA

STAPLE GUN 3 IN 1

-  | 6 - 14 mm
23960 - 23964
-  | 14 mm
23966
-  | 14 mm
23967



No.	specification	
23923		12



FESTA

STAPLE GUN

-  53 | 4 - 14 mm
23904 - 23914,
23760 - 23765

No.	specification	
23925	4 - 14 mm with lock out	20



STAPLE GUN

-  53 | 4 - 14 mm
23760 - 23765,
23904 - 23914

No.	specification	
23800		20



STAPLE GUN



-  | 0,7 mm
a=9-11 mm, b=5,5mm, c=6,4mm

No.	specification	
23920		4



FESTA

STAPLE HAMMER

-  | 6 - 10 mm
23960 - 23962

No.	specification	
23922		10



STAPLE HAMMER

-  | 6 - 10 mm
23960 - 23962

No.	specification	
23928		6



FESTA

STAPLES EXTRACTOR

No.	specification	
23945		25

FESTA

STAPLES EXTRA



No.	specification	
23960	b=6 mm, 1000 pcs	50
23961	b=8 mm, 1000 pcs	50
23962	b=10 mm, 1000 pcs	50
23963	b=12 mm, 1000 pcs	50
23964	b=14 mm, 1000 pcs	50

FESTA

STAPLES

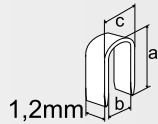

No.	specification	
23965	a=12 mm, b=6,5 mm, c=7,5 mm, 1000 TW	50

STAPLES - TYPE 53



No.	specification	
23904	b=4 mm 1000 pcs	200
23906	b=6 mm 1000 pcs	200
23908	b=8 mm 1000 pcs	200
23910	b=10 mm 1000 pcs	200
23912	b=12 mm 1000 pcs	200
23914	b=14 mm 1000 pcs	200

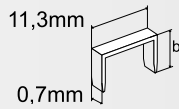

FESTA

NAILS



No.	specification	
23966	nails 14 mm 1000 TW	100

FESTA

NAILS



No.	specification	
23967	nails 14 mm 1000 TW	100

STAPLES - TYPE 53



No.	specification	
23760	b=4 mm 2000 pcs	10
23761	b=6 mm 2000 pcs	10
23762	b=8 mm 2000 pcs	10
23763	b=10 mm 2000 pcs	10
23764	b=12 mm 2000 pcs	10

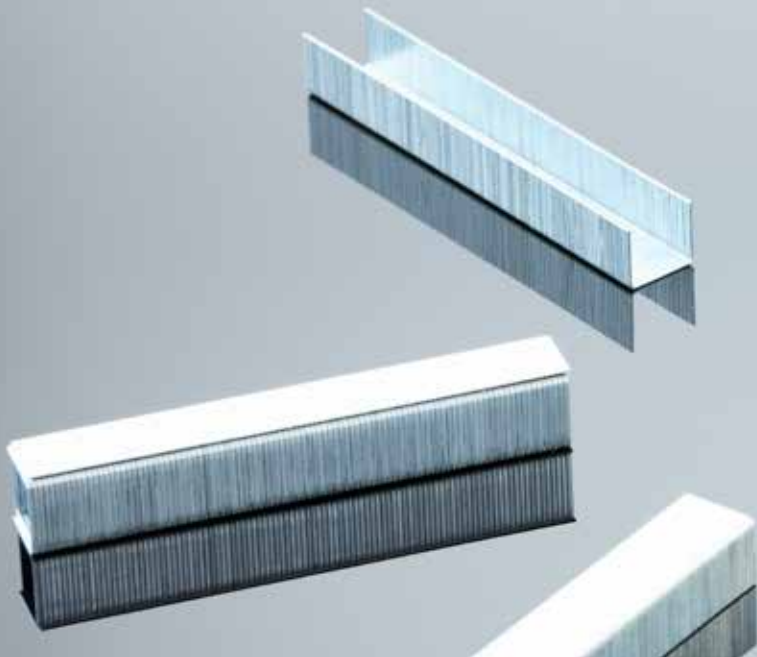
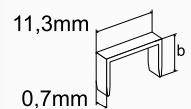

FESTA



MARTIN MACK 21.01
FRANTIŠEK TOMÁŠEK 41.01
DAVID ŠVANDA 48.01

aramco
600
DREAM. DARE. LIVE IT.

aramco

CATREX

E

OMP

OMP

OMP

TECHNOLOGY

FESTA

122PCS

FESTA

WIRE BRUSH, PLASTIC



No.	specification	lines	
22080	270 mm	5 lines	12

FESTA

HAND BRUSH, BRASS



No.	specification	lines	
22082	270 mm	5 lines	12

FESTA

WIRE BRUSH, STEEL, BRUSH COATED SET



· nylon, inox, brass

3x



No.	specification	
22086	180 mm	12

WIRE BRUSH, STEEL, BRUSH COATED SET



3x



No.	lines	
22081	3 lines	12



WIRE BRUSH

No.	specification	wire	
22158	200 mm	steel	1
22159	200 mm	brass	1



WIRE BRUSH, PLASTIC

No.	specification	wire	
22035	270 mm	steel	24
22036	270 mm	stainless steel	24



WIRE BRUSH

No.	specification	lines	
22033	300 mm	4 lines	12
22034	300 mm	5 lines	12



WIRE BRUSH BRASS

No.	lines	
22078	3 lines	20

· brass coated



WIRE BRUSH BRASS

No.	specification	lines	
22079	300 mm	4 lines	6

· brass coated

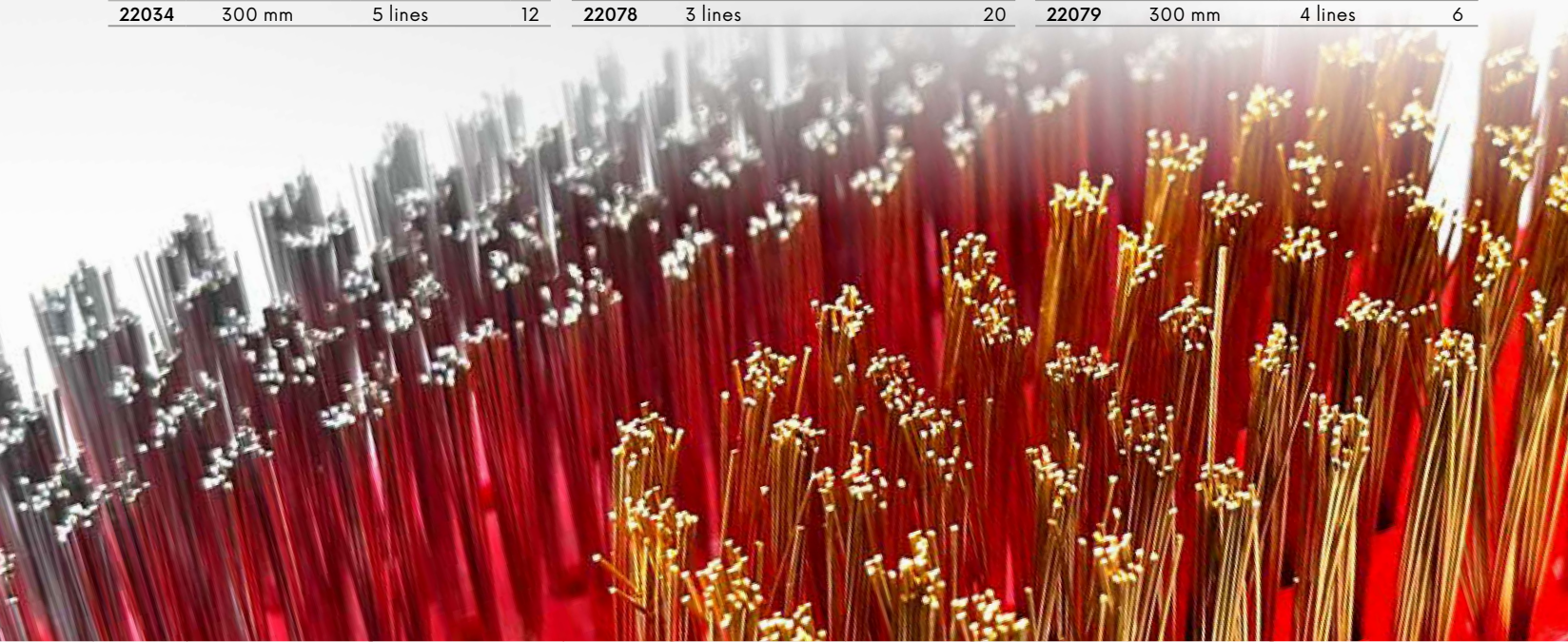

FESTA



FESTA

FLAT FILE



No.	specification	asperity	
22206	150 mm	2	10
22180	250 mm	2	10



FESTA

CABINET FILE



No.	specification	asperity	
22207	150 mm	2	10
22182	250 mm	2	10



FESTA

FOURSQUARE FILE



No.	specification	asperity	
22184	250 mm	2	10



FESTA

TRIANGULAR FILE



No.	specification	asperity	
22183	250 mm	2	10



FESTA

ROUND FILE



No.	specification	asperity	
22181	250 mm	2	10



FESTA

TRIANGULAR FILE FOR SAW BLADES



No.	specification	asperity	
22178	150 mm	1	10

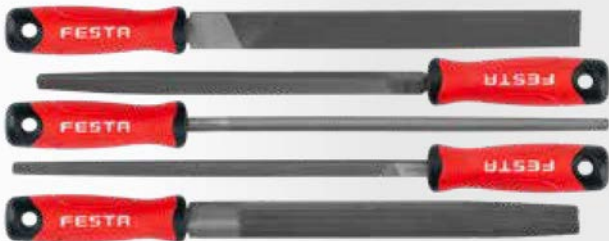

FESTA

FILE SET



No.	specification	asperity	
22209	150 mm	2	10
22186	250 mm	2	5



FESTA

FILE SET



No.	specification	asperity	
22208	150 mm	2	10
22185	250 mm	2	5



FESTA

FILE FOR CHAIN SAW



No.	specification	
22170	200 mm 3,5 mm	10
22171	200 mm 4 mm	10
22172	200 mm 4,5 mm	10

No.	specification	
22173	200 mm 5 mm	10
22174	200 mm 5,5 mm	10



Ø 4 mm

FESTA

SET FOR CHARPENING SAW CHAIN



No.	specification	
22190	300 mm	5



FESTA

NEEDLE FILE SET



10x	No.	specification	
	22188		20



FESTA

DIAMOND FILE SET



10x	No.	specification	
	22189		25



FESTA

FLAT RASP



No.	specification	
22202	150 mm	10
22197	300 mm	10



FESTA

RASP SET



3x	No.	specification	
	22196	250 mm	5



FESTA

CABINET RASP



No.	specification	
22203	150 mm	6
22199	300 mm	6



FESTA

ROUND RASP



No.	specification	
22204	150 mm	10
22205	250 mm	10
22198	300 mm	10



FESTA

METAL HAND SAW



FESTA

METAL HAND SAW

· heavy duty



HAND SAW FOR METAL

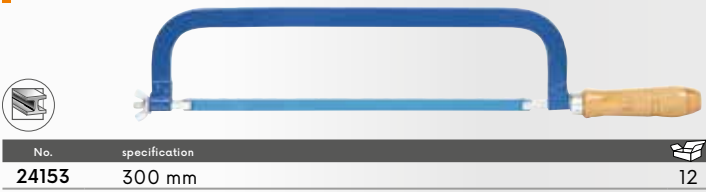

FESTA

HAND SAW FOR METAL



HAND SAW FOR METAL

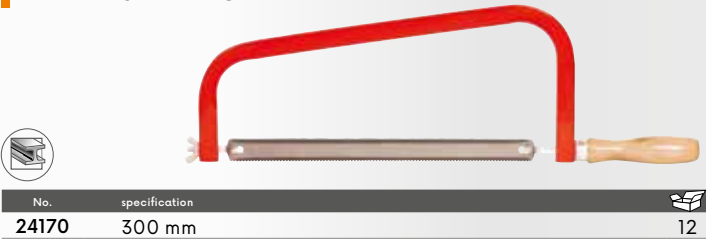

FESTA

HAND SAW FOR METAL



FESTA

HACKSAW

· blades 24108

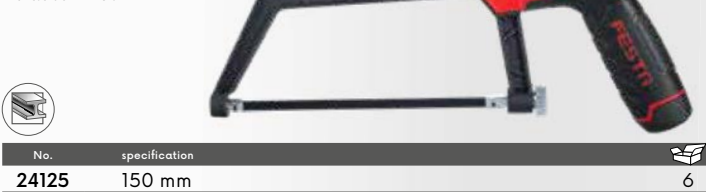

FESTA

HACKSAW

· blades 24109

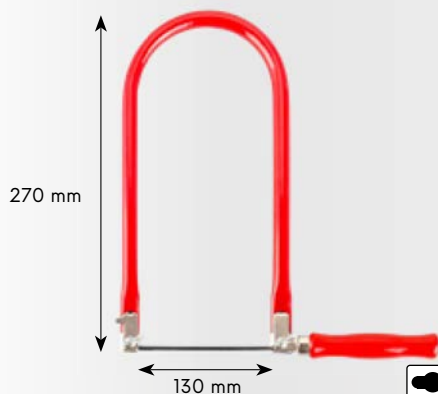

HAND SAW

No. No.	specification	
24121	saw	12
24110	saw blade	30



HAND SAW

· 5x saw blade

No. No.	specification	
24122	saw	20
24111	saw blade	30

FESTA

HAND SAW

TEFLON · 3 x sharpened and heat treated teeth

No.	specification	
24143	300 mm	12
24144	400 mm	12
24145	500 mm	12



FESTA

TENON SAW

TEFLON · 3 x sharpened and heat treated teeth

No.	specification	
24147	300 mm	6



FESTA

WOOD HAND BOARD SAW

· 3 x sharpened and heat treated teeth

No.	specification	
24149	300 mm	12



FESTA

JAPANESE SAW

SK5 · 3 x sharpened and heat treated teeth

No.	specifications	
24134	250 mm 0,5 mm	10



FESTA

JAPANESE SAW

SK5 · 3 x sharpened and heat treated teeth

No.	Specifications	
24115	260 mm 0,6 mm	10

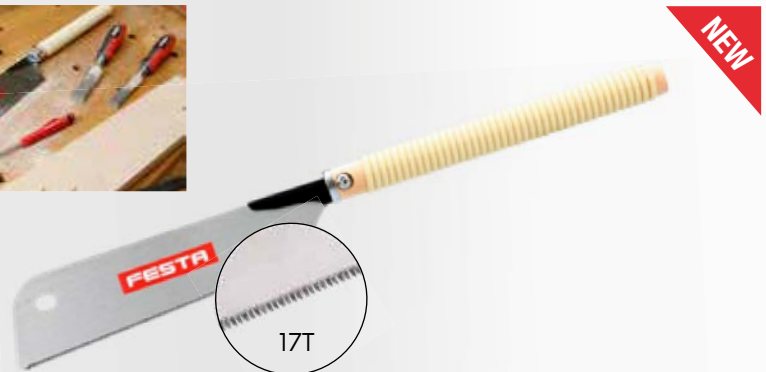

FESTA

JAPANESE SAW

SK5 · 3 x sharpened and heat treated teeth

No.	Specifications	
24114	260 mm 0,6 mm	10

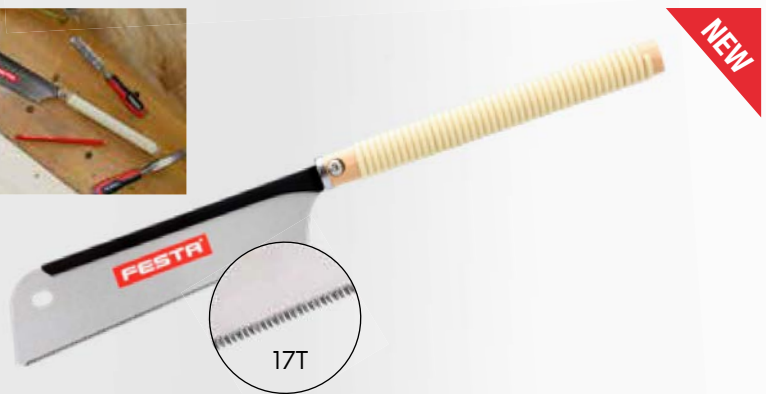

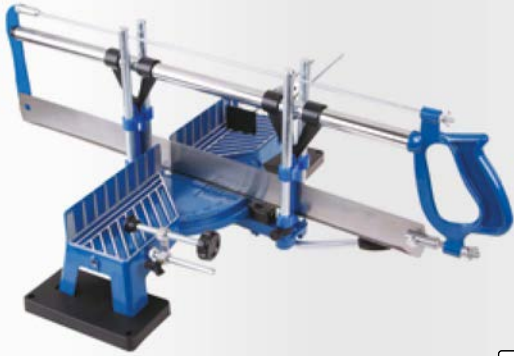

MITER SAW



No.	specification	
24130	600 mm	1
24131	600 mm, saw blade	1



MITER BOX PLASTIC + SAW



No.	specification	
24148	300 mm	25

MITER BOX WOODEN



· beech
MADE IN EU

No.	specification	
24171	80 x 300 mm	10

MITER BOX PLASTIC



No.	specification	
24133	300 x 140 mm	18

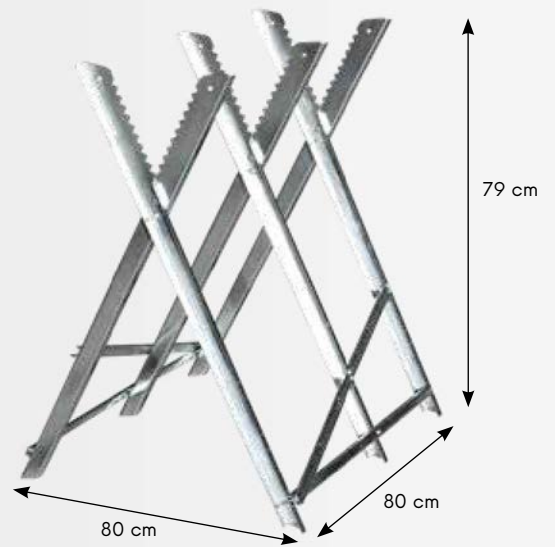

WOOD CUTTING STAND



No.	specification	
37570	max. 150 kg	3

FESTA

PRUNING SAW

· heat treated teeth



No.	specification		No.	specification	
24141	450 mm	12	24136	760 mm	12
24140	533 mm	12	24142	800 mm	12
24135	610 mm	12	24137	914 mm	12

FESTA

SWIVEL SAW

· heat treated teeth



No.	specification	
24173	350 mm	24

PRUNING HAND SAW



No.	specification	
24151	300 mm	10

PRUNING SAW



No.	specification	
24150	300 mm	5

SAW

No.	specification	
24128	450 mm blades 24192	6



FESTA

FOLDING SAW



· 3 x sharpened and heat treated teeth



No.	specification	
45061	150 mm with cover of handle	12



FESTA

FOLDING SAW



· 3 x sharpened and heat treated teeth



No.	specification	
45060	180 mm	6



FESTA

SAW WITH CASE



· 3 x sharpened and heat treated teeth



No.	specification	
45062	260 mm with case	24



PRUNING HAND SAW



· 3 x sharpened and heat treated teeth



No.	specification	
24152	350 mm 6 tpi	12

FESTA

TELESCOPIC POLE SAW



· 3 x sharpened and heat treated teeth



No.	specification	
45033	230 - 490 mm	1

CATTERPILAR WITH SAW



No.	specification	
45030	saw 30 cm	6
45031	saw 30 cm	6

CATTERPILAR



No.	specification	
45032	metal catterpillar without saw	6

FESTA

POLYSTYRENE SAW



No.	specification	
24174	380 mm	1

FESTA

SAW FOR POROTHERM



No.	specification	
24181	550 mm	1

FESTA

CONCRETE SAW



No.	specification	
24158	22 22 SK teeth - 450 mm	5

FESTA

CONCRETE SAW

· heat treated teeth



No.	specification	
24175	without SK teeth - 600 mm EU	2
24178	without SK teeth - 600 mm	6

FESTA

DRYWALL SAW



· 3 x sharpened and heat treated teeth



No.	specification	
24159	150 mm	12

DRILLING SAW FOR DRYWALL



No.	specification	
24190	270 mm	10

FESTA

CONCRETE SAW



No.	specification	
24155	34 17 SK teeth - 600 mm	2
24156	34 34 SK teeth - 600 mm	2

FESTA

CONCRETE SAW



No.	specification	
24176	34 17 SK teeth - 750 mm	6
24177	34 34 SK teeth - 750 mm	6





FESTA
HAMMER

· ash handle

DIN
1041

No.	specification	
19081	100 g	1
19082	200 g	1
19083	300 g	1
19084	400 g	1
19085	500 g	1
19086	600 g	1
19088	800 g	1
19090	1000 g	1
19092	1500 g	1
19095	2000 g	1



FESTA
MALLET

· ash handle

DIN
1041

No.	specification	
19096	3000 g	1
19097	4000 g	1
19098	5000 g	1
19106	6000 g	1
19108	8000 g	1
19109	10000 g	1



FESTA
MALLET

· ash handle

DIN
6475

No.	specification	
19041	1000 g	1
19042	1250 g	1
19043	1500 g	1
19044	2000 g	1



FESTA
MALLET

· ash handle

DIN
6475

No.	specification	
19045	3000 g	1
19046	4000 g	1
19074	5000 g	1
19075	6000 g	1
19076	8000 g	1
19077	10000 g	1



FESTA
HAMMER
FIBERGLASS

· fiberglass handle

Č.p.	specifikace	
19021	100 g	12
19022	200 g	12
19023	300 g	12
19024	400 g	12
19025	500 g	12
19026	600 g	6
19028	800 g	6
19030	1000 g	6
19031	1500 g	6
19032	2000 g	1



FESTA
MALETT
FIBERGLASS

· fiberglass handle

DIN
6475

Č.p.	specifikace	
19066	1000 g	4
19067	1250 g	4
19068	1500 g	4
19069	2000 g	2



FESTA
MALETT
FIBERGLASS

· circular wedge

Č.p.	specifikace	
19034	3000 g	4
19036	4000 g	4



FESTA
MALLET
FIBERGLASS

DIN
6475

Č.p.	specifikace	
19070	3000 g	4
19071	4000 g	4
19058	5000 g	4
19059	6000 g	2

FESTA

ROOF
HAMMER
FIBERGLASS

· fiberglass handle



Č.p.	specifikace	
19061	600 g	6



FESTA

CLAW HAMMER
FIBERGLASS

· fiberglass handle

Č.p.	specifikace	
19064	450 g	6



FESTA

ROOF
HAMMER
MONOLIT



Č.p.	specifikace	
19062	600 g	6



FESTA

CLAW
HAMMER
MONOLIT

Č.p.	specifikace	
19063	450 g	6



ROOF
HAMMER



Č.p.	specifikace	
19100	600 g	6



FESTA

MASONRY
HAMMER
MONOLIT

Č.p.	specifikace	
19150	600 g	6



FESTA

ROOF HAMMER



Č.p.	specifikace	
19060	600 g	6



FESTA

CLAW HAMMER

Č.p.	specifikace	
19065	450 g	6



FESTA

MASONRY
HAMMER
FIBERGLASS

· fiberglass handle

Č.p.	specifikace	
19151	600 g	6



FESTA

MASONRY HAMMER

· ash handle

Č.p.	specifikace	
19149	44 mm	1



FESTA

MASONRY HAMMER

· ash handle

Č.p.	specifikace	
19124	24 mm	1
19136	36 mm	1
19148	48 mm	1



FESTA

HAMMER - AXE

Č.p.	specifikace	
19303	600 g	6



FESTA

MALETT

Č.p.	specifikace	
19051	1000 g	6
19052	1500 g	6



MALETT

· circular wedge

DIN 6475



Č.p.	specifikace	
19053	1000 g	6
19050	1250 g	6
19054	1500 g	6
19055	2000 g	6

HAMMER

· fiberglass handle

DIN 1041



Č.p.	specifikace	
19001	100 g	12
19002	200 g	12
19003	300 g	6
19004	400 g	6
19005	500 g	6
19006	600 g	6
19008	800 g	6
19010	1000 g	6
19015	1500 g	6
19020	2000 g	6

MALETT

· circular wedge

DIN 6475



Č.p.	specifikace	
19056	3000 g	6
19057	4000 g	6

WELDING HAMMER



Č.p.	specifikace	
19115	320 g	1



FESTA

ASH HANDLE FOR HAMMER

No.	specification	
61240	handle	1



ASH HANDLE FOR HAMMER



No.	specification	for axe	
61320	26 cm	19081	10
61321	28 cm	19082	10
61322	30 cm	19083	10
61323	31 cm	19084	10
61324	32 cm	19085	10



ASH HANDLE FOR MALETT



No.	specification	for malett	
61330	80 cm	19074, 19075	10
61331	90 cm	19076, 19077	10



CONICAL CIRCULAR WEDGE

No.	specification	
19430	6 mm	10
19431	8 mm	10
19432	10 mm	10
19433	12 mm	10
19434	14 mm	10
19435	16 mm	10



FORGED WEDGE



No.	specification	
19440	narrow	10
19441	middle	10
19442	wide	10
19443	wide S	10



FESTA

STEEL WEDGE



3x

No.	specification	
19398	20 x 25 x 5 mm	1
19399	30 x 40 x 5 mm	1





FESTA



FESTA

WOODEN MALLET

• beech wood



No.	specification	
19202	Ø 60 x 120 mm 260 g	1



FESTA

RUBBER MALLET

• ash handle



No.	specification	
19245	Ø 55 mm 400 g	1
19246	Ø 60 mm 800 g	1
19247	Ø 70 mm 1000 g	1
19248	Ø 95 mm 2000 g	1
19249	Ø 115 mm 3000 g	1

FESTA

RUBBER MALLET

· fiberglass handle



No.	specification	
19270	Ø 55 mm	6
19271	Ø 65 mm	6
19272	Ø 90 mm	6



FESTA

RUBBER MALLET



No.	specification	
19255	Ø 55 mm	6
19265	Ø 65 mm	6
19290	Ø 90 mm	6



FESTA

WHITE RUBBER MALLET

· fiberglass handle

No.	Specifications	
19281	680g	6



FESTA

WHITE RUBBER MALLET



No.	specification	
19293	Ø 55 mm	6
19294	Ø 65 mm	6
19295	Ø 90 mm	6



FESTA

BRASS MALETT

· fiberglass handle

No.	specification	
19211	Ø 30 mm 500 g	1



FESTA

NYLON MALLET

· fiberglass handle



No.	specification	
19209	Ø 34 mm	6



RUBBER MALLET



No.	specification	
19251	Ø 55 mm 400 g	12
19252	Ø 65 mm 700 g	6
19253	Ø 90 mm 1300 g	4



**RUBBER MALLET
BLACK-WHITE**



No.	specification	
19254	Ø 65 mm	6



**SILICON
HAMMER**

No.	specification	
19297	Ø 30 mm	12



FESTA

MALLET WITH REPLACEABLE HEADS

- PP - 97 Shore A ·
- TPU - 95 Shore A ·
- TPE - 90 Shore A ·
- TPE - 90 Shore A ·
- TPU - 92 Shore A ·
- TPU - 92 Shore A ·
- TPU - 88 Shore A ·
- TPE - 90 Shore A ·

No.	specification	
19208	Ø 38 mm	1

TINMANS SET



7x

No.	specification
19110	



FESTA

CROWBAR



No.	Specifications	Box
19420	300 mm	1



FESTA

OVAL PULLER

No.	specification	Box
19424	400 mm	6
19425	600 mm	6
19426	800 mm	6
19427	1000 mm	6



CROWBAR

No.	specification	Box
19416	600 mm Ø 16 mm	4
19422	800 mm Ø 16 mm	4
19421	1000 mm Ø 18 mm	4



CROWBAR

No.	specification	Box
19423	380 x 35 x 6 mm	1



FESTA

NAIL PULLER

No.	specification	Box
19415	300 mm Ø 15 mm	6





FESTA

FLAT CHISEL

CrV	No.	specification	the tip width	
	19406	300 mm	25 mm	5
	19407	400 mm	30 mm	5



FESTA

POINT CHISEL

CrV	No.	specification		
	19408	250 mm		5
	19409	350 mm		5



FESTA

FLAT CHISEL

CrV	No.	specification	the tip width	
	19460	300 mm	25 mm	5
	19470	400 mm	30 mm	5



POINT CHISEL

No.	specification	
19400	250 mm	5
19403	350 mm	6



FLAT CHISEL

No.	specification	the tip width	
19401	250 mm	19 mm	6
19404	350 mm	22 mm	6



FLAT CHISEL

No.	specification	the tip width	
19402	250 mm	50 mm	2
19405	350 mm	50 mm	6



FESTA

SET OF PUNCHES AND CHISELS

12x CrV

- 2, 6, 8 mm
- 10, 12, 16 mm
- Ø 1,5-3-4-5-6-8 mm

No.	specification	
19487		4



FESTA

SET OF PUNCHES AND CHISELS

6x CrV

- 2 x 140, 8 x 115 mm
- 12 x 152, 10 x 142 mm
- Ø 3 x 152, 6 x 152 mm

No.	specification	
19486		10



FESTA

SET OF CHISELS

3x CrV

- 10, 12, 16 mm

No.	specification	
19485		10



FESTA

POINT CHISEL

CrV

No.	specification	
19429	200 mm	1



FESTA

FLAT CHISEL

CrV

No.	specification	the tip width	
19410	200 mm	20 mm	10
19411	250 mm	25 mm	10
19412	300 mm	25 mm	10
19418	400 mm	25 mm	5
19419	500 mm	25 mm	5



FLAT CHISEL

CrV

No.	specification	the tip width	
19436	200 mm	20 mm	15

FESTA

SET OF PUNCHES

CrV 3x

No.	specification	
19480	Ø 0,8, 1,5, 2,5 mm	10



FESTA

CENTRE PUNCH SET

CrV 3x

No.	specification	
19481	Ø 0,8, 1,5, 2,5 mm	10



FESTA

SET OF PUNCHES

CrV 6x

No.	specification	
19483	Ø 3, 4, 5, 6, 7, 8 mm	5



FESTA

CENTRE PUNCH

CrV

No.	specification	
19477	Ø 2,5 mm	20



FESTA

CENTRE PUNCH AUTOMATIC

CrV

No.	specification	
19478	Ø 2,5 mm	12



FESTA

PUNCH

CrV

No.	specification	
19472	Ø 4 mm 150 mm	1
19473	Ø 5 mm 150 mm	1
19474	Ø 6 mm 150 mm	1



GLASS CUTTER



No.	specification	
20350	130 mm	12



PUNCH SET

- 24690 - Ø 2,5 mm
- Ø 3 mm
- Ø 4 mm
- Ø 5 mm
- Ø 6 mm
- Ø 7 mm
- Ø 8 mm
- Ø 9 mm
- Ø 10 mm
- 24691 - Ø 2 mm
- Ø 2,5 mm
- Ø 3,2 mm
- Ø 4 mm
- Ø 4,8 mm
- Ø 5 mm
- Ø 6,4 mm
- Ø 8 mm
- Ø 9,5 mm
- Ø 11,1 mm
- Ø 12,7 mm
- Ø 14 mm
- Ø 15,8 mm
- Ø 19 mm
- Ø 22 mm



No.	specification	
24690	9 pcs Ø 2,5 - 10 mm	10
24691	15 pcs Ø 2 - 22 mm	5

PUNCH SET

No.	specification	
13x 24695	Ø 5, 6, 8, 10, 11, 13, 16, 19, 22, 25, 28, 32, 35 mm	5



NUMBER PUNCH

No.	specification	
20972	6 mm	5
20973	8 mm	5



LETTER PUNCH

No.	specification	
20970	6 mm	5
20971	8 mm	5





QUICK GRIP CLAMP

Č.p.	specifikace	
23625	150 mm	6
23626	300 mm	6
23628	450 mm	6
23630	600 mm	6
23632	760 mm	6



NEW



EXTENSION FOR QUICK GRIP CLAMPS

FESTA INDUSTRY 23625, 23626, 23628, 23630

2x

No.	Specifications	
23635		6



QUICK GRIP CLAMP



Č.p.	specifikace	
23570	100 x 80 mm	1
23571	160 x 80 mm	1
23572	200 x 80 mm	1
23573	250 x 80 mm	1
23574	300 x 80 mm	1

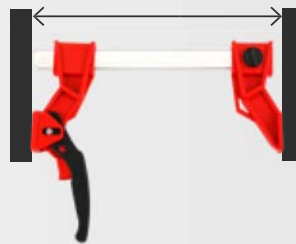

STEEL CLAMP

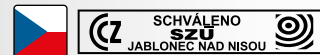

Č.p.	specifikace	
23670	150 x 105 mm	1
23671	200 x 105 mm	1
23672	250 x 105 mm	1
23673	300 x 105 mm	1
23674	350 x 105 mm	1
23675	400 x 175 mm	1
23676	500 x 175 mm	1
23677	600 x 175 mm	1
23678	700 x 175 mm	1
23679	800 x 175 mm	1
23680	1000 x 175 mm	1
23681	1250 x 175 mm	1
23682	1500 x 175 mm	1
23683	1750 x 175 mm	1
23684	2000 x 175 mm	1
23685	2200 x 175 mm	1



QUICK GRIP CLAMP

Č.p.	specifikace	
23585	150 mm	6
23587	300 mm	6
23589	450 mm	6
23591	600 mm	6



FESTA

QUICK GRIP CLAMP

• drop forged

Č.p.	specifikace	
23560	200 x 80 mm	1
23561	300 x 100 mm	1
23562	400 x 100 mm	1
23563	500 x 120 mm	1
23564	600 x 120 mm	1
23565	800 x 120 mm	1
23566	1000 x 120 mm	1



CLAMP

DIN 5117

Č.p.	specifikace	
23506	300 x 120 mm	10
23507	500 x 120 mm	10
23508	800 x 120 mm	6



CLAMP

Č.p.	specifikace	
23515	150 x 50 mm	50
23520	200 x 50 mm	50
23525	250 x 50 mm	50
23530	300 x 50 mm	50
23531	300 x 120 mm	20
23551	500 x 120 mm	10



NEW



FESTA

QUICK GRIP CLAMP FOR WORKBENCHES



No.	Specifications	
23595	250/ Ø 20 mm 60 kg	1



NEW

FESTA

QUICK GRIP CLAMP FOR WORKBENCHES



No.	Specifications	
23598	120/ Ø 20 mm 70 kg	1

NEW



FESTA

VARIABLE ANGLE STRAP CLAMP



No.	Specifications	
23637	4m x 25mm	1





FESTA

90° CORNER CLAMP



4x

No.	specifications	
23607	clamping force - 250 N	1



VICE ALU WITH SWIVEL TABLE 90°

ALU

* range 0 - 65 mm



No.	specification	
23420	65 mm	20



RATCHET CLAMP

* span 80 mm

No.	specification	
23605	9' 230 mm	6



PLASTIC CLAMP

No.	specification	
23600	4', span 40 mm	20
23601	6', span 70 mm	12
23602	9', span 100 mm	20



CLAMP SET

3x

No.	specification	
23620	25 mm, 50 mm, 75 mm	10



FESTA



208

WORK BENCHES



212

VICES



213

HYDRAULIC JACKS



218

LIGHTS



220

TIE-DOWN STRAP



224

TAPES



227

SNAP HOOKS,
CHAINS, WIRE ROPES

230

SAFETY EQUIPMENTS



234

MOUNTING BELTS, BAGS
AND CASES

237

LOCK, PADLOCK,
BICYCLE LOCK

239

MONEY BOX AND MAILBOX

WORKSHOP

208 - 243



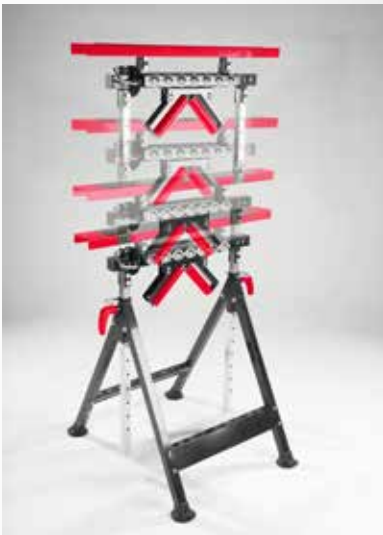

max 200 kg



max 45 kg



max 100 kg



max 100 kg



FESTA

FOLDING SAW HORSE 4in1

· max. load: 200 kg

No. Specifications
36410

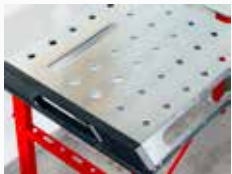

FESTA

WORKBENCH FOLDABLE

· max. load: 450 kg

No. Specifications
23652



FESTA

FOLDING SAW HORSE

· max. load: 590 kg

No. Specification
23657



NEW



2x



4x

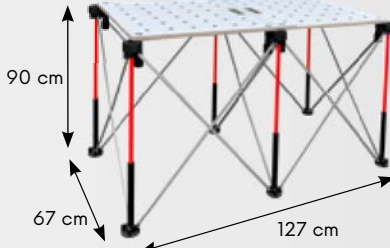
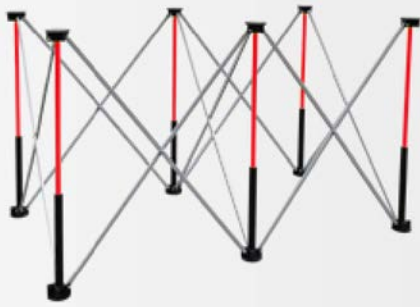

FESTA

CENTIPEDE PORTABLE WORKSTAND 3x2

- 1270 x 670 x 900 mm
- max. load: 1100 kg

No. Specifications
23661



1

NEW



8x

FESTA

CENTIPEDE WORKBENCH TABLE

- 1200 x 600 x 18 mm

No. Specifications
23664



1



FESTA

SAW HORSE

- max. load: 230 kg

No. specifications
23658



1

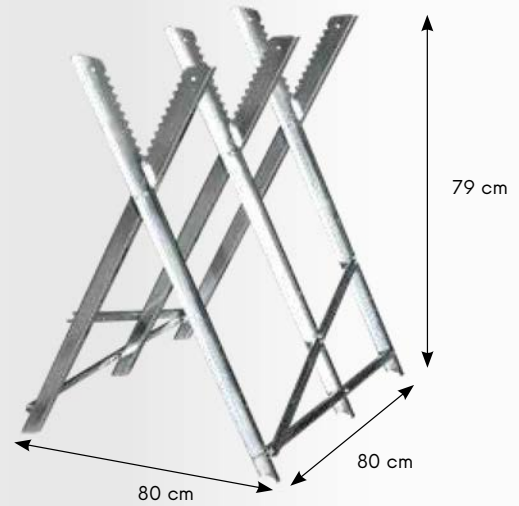

GOAT ON WOOD CUTTING

- max. load: 150 kg

No. specifications
37570



1



ADJUSTABLE SAW HORSE

- max. load: 125 kg

No. specification
36300



1



PLASTIC SAW HORSE

- max. load capacity 150 kg (300 kg in pair)

2x

No. specification
37560



1

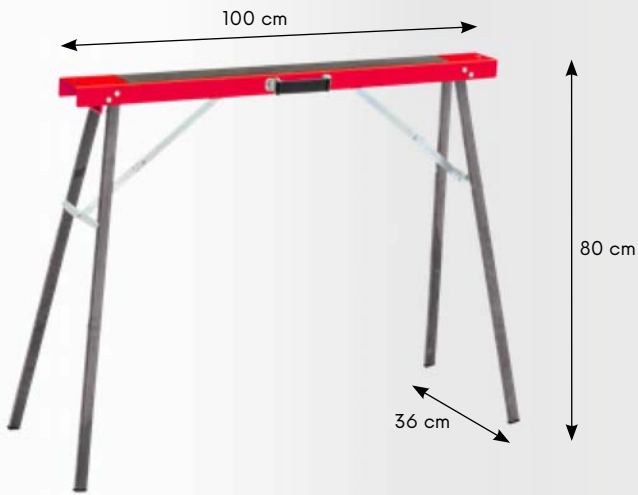

FOLDABLE SAW HORSE

· max. load capacity 125 kg

2x			
No.	specification		
37549		1	

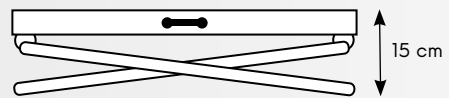

WORK BENCH

· max. load 100 kg

No.	Specification		
23655	100 x 50 x 84 cm	1	



WORK BENCH

· ideal for cellars

No.	specification		
23660		1	



MULTIFUNCTIONAL WORK BENCH

· max. load: 100 kg

No.	specification		
23650		1	



CAR CREEPER

· padded roller seat with plastic tool tray.

No.	Specification		
26988	360 x 365 x 365 mm	1	

FESTA

MAGNETIC TOOL HOLDER



No.	specification		
70098		12	



FESTOOL

TOOL CABINET

No.	Drawers slides	Drawers	Overall dimensions (mm)	
26986	smooth	7	680 x 460 x 1020 mm	1



TOOL CABINET

· top chest can be put into roller cabinet

No.	specification	Drawers slides	Drawers	Drawes inside dimensions WxDxH (mm)	Overall dimensions (mm)	Total weight (kg)	
26985	top case	smooth	3	151,5 x 225 x 40 mm	600 x 260 x 340 mm	11,5 kg	1
			2	511 x 225 x 40 mm			
	bottom case	smooth	1	511 x 225 x 85 mm	616 x 330 x 742 mm	16,4 kg kg	
			2	511 x 308 x 85 mm			

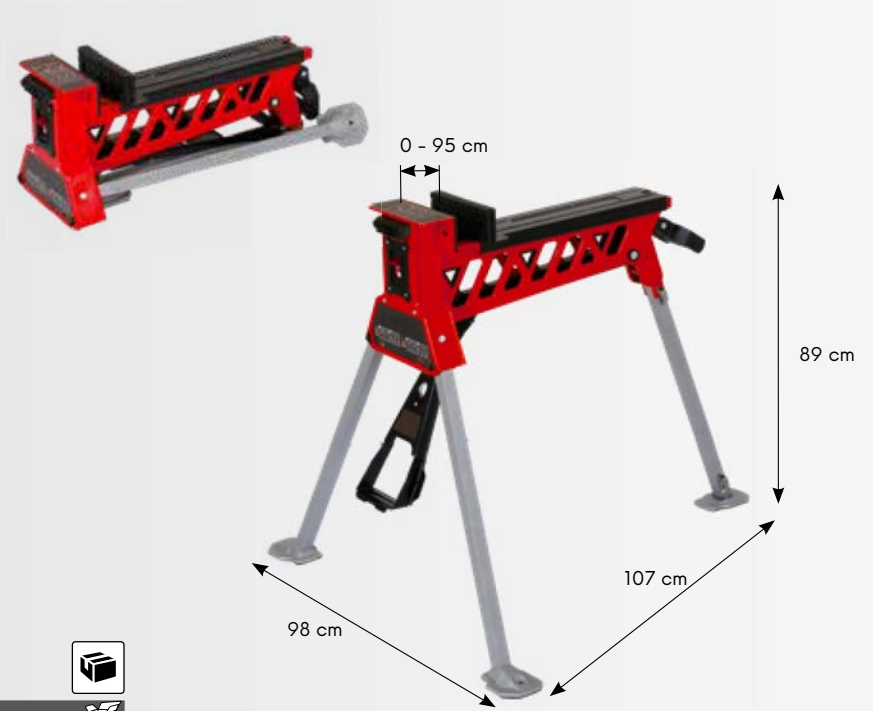

FESTA
PORTABLE STAND VISE

- clamping range: 0 - 95 cm
- max. load: 250 kg

No.	Specification	
37553		1



FESTA
VICE

- hardened jaw

No.	specification		
23410	100 mm	1	
23411	125 mm	1	
23412	150 mm	1	



SWIVEL VICE

- hardened jaw

No.	specification		
23415	100 mm	1	
23416	125 mm	1	
23417	150 mm	1	



SWIVEL VICE

No.	specification	
23407	65 mm	10



DRILL MACHINE VICE

- hardened jaw

No.	specification	
23400	18 80 mm	10
23401	22 100 mm	10
23402	24 125 mm	5



VICE ALU WITH SWIVEL BASE 360°

ALU	No.	specification	
	23406	80 mm	24



HYDRAULIC BOTTLE JACK, ONE PISTON

- extension screw allows low pickup height adjustment and maximum lift
- double safety bypass valve
- serrated saddle provides generous lifting area and secure grip
- a wide base provides stability and strength
- all models critical stress points are reinforced for added durability and dependability



No.	capacity	min. height	lift	adjust height	base dimensions	Weight	
26800	2 000 kg	181mm	116 mm	48 mm	88 x 92 mm	2,6 kg	1
26801	3 000 kg	194 mm	118 mm	60 mm	92 x 100 mm	3,3 kg	1
26802	5 000 kg	216 mm	127 mm	70 mm	96 x 112 mm	4,5 kg	1
26803	8 000 kg	230 mm	147 mm	80 mm	103 x 118 mm	5,7 kg	1
26804	10 000 kg	230 mm	150 mm	80 mm	110 x 123 mm	6,8 kg	1
26805	12 000 kg	230 mm	155 mm	80 mm	116 x 134 mm	7,3 kg	1
26806	15 000 kg	230 mm	150 mm	80 mm	133 x 136 mm	8,4 kg	1
26807	20 000 kg	242 mm	150 mm	60 mm	144 x 152 mm	11 kg	1



HYDRAULIC BOTTLE JACK, DOUBLE PISTON

- extension screw allows low pickup height adjustment and maximum lift.
- double safety bypass valve.
- serrated saddle provides generous lifting area and secure grip.
- a wide base provides stability and strength
- all models critical stress points are reinforced for added durability and dependability.



No.	capacity	min. height	lift	adjust height	Weight	
26815	2 000 kg	150 mm	160 mm	60 mm	4,7 kg	1
26816	4 000 kg	160 mm	170 mm	60 mm	6,4 kg	1
26817	6 000 kg	215 mm	270 mm	-	8,9 kg	1
26819	10 000 kg	228 mm	284 mm	89 mm	10,2 kg	1



SCISSORS JACK



No.	capacity	min. height	max. height	Weight	
26844	1 000 kg	88 mm	380 mm	2,5 kg	1
26845	2 000 kg	120 mm	395 mm	3,5 kg	1



HYDRAULIC LIFTING JACK



No.	specification	capacity	min. height	max. height	Weight	
26820	Hydraulic trolley jack 2t, portable	2 000 kg	130 mm	345 mm	9,6 kg	1
26822	Hydraulic trolley jack 3t, portable	3 000 kg	130 mm	465 mm	27,4 kg	1
26826	Hydraulic garage jack, low profil, 360° rotating handle	2 000 kg	89 mm	359 mm	14,2 kg	1
26824	Hydraulic garage jack, foot handle	3 000 kg	145 mm	500 mm	37,2 kg	1
26825	Hydraulic garage jack, low profil, profil	2 500 kg	85 mm	455 mm	34,8 kg	1

HYDRAULIC TROLLEY JACK + JACK STANDS

· 360° rotating handle



No.	capacity	min. height	max. height	Weight	
26829	2 000 kg	130 mm	350 mm	10,5 kg	1
	2 000 kg	275 mm	420 mm	5 kg (pair)	

JACK STAND

- 1pc = 1pair
- ratchet type for fine adjustable with double locking protection
- solid steel handle
- large saddle, unitized frame construction
- ductile iron rack



No.	specification	capacity	min. height	max. height	Weight	
26857	with lock pin	2 000 kg	275 mm	420 mm	4,8 kg	1
26858	with lock pin	3 000 kg	285 mm	425 mm	6,3 kg	1
26859	with lock pin	6 000 kg	393 mm	593 mm	13 kg	1
26853		12 000 kg	465 mm	715 mm	28 kg	1

HYDRAULIC CRANE JACK, FOLDABLE

- for lifting and fixing units during its mounting and demounting from cars
- crane boom has a few position of extension
- the crane can easily be folded for storage

No.	capacity	min. height	max. height	Weight	
26862	2 000 kg	0	2360 mm	88 kg	1



ENGINE SUPPORT

· swinging suspension of the arm, depends on the cowl slope, ensuring always balanced and stable engine fixing

No.	capacity	length	range	Weight	
26871	500 kg	1500 mm	150 mm	20,3 kg	1



HYDRAULIC TRANSMISSION JACK

· easy mounting and demounting units (engines, transmissions, axles etc.)

No.	specification	capacity	length	range	Weight	
26880	Hydraulic transmission jack	500 kg	1100 mm	1900 mm	30,0 kg	1



26880



PORTABLE HYDRAULIC EQUIPMENT

- hydraulic equipment for repairing vehicle bodies
- it's provided with piston cylinder and 14 pcs accessories
- it is wide applicable to repair car and truck bodies, especially to field work without power supply
- during its use, the accessories can push, pull, lift and extend in vertical and horizontal directions
- easy transporting in blow mold case



No.	capacity	hydraulic lift	Weight	
26886	4 000 kg	125 mm	17,0 kg	1
26888	10 000 kg	135 mm	32,0 kg	1



ENGINE STAND

- movable stand for mounting and working on demounted engines
- universal clamping unit for fastening the engine and its rotating



No.	capacity	Weight	
26920	450 kg	20 kg	1



HYDRAULIC PIPE BENDER

No.	Capacity	Lift height	Bending shoes	Weight	
26895	12 000 kg	232 mm	1½", ¾", 1", 1-1¼", 1-1½", 2"	36 kg	1
26896	16 000 kg	238 mm	1½", ¾", 1", 1-1¼", 1-1½", 2", 2-1½", 3"	65 kg	1



26897



26943

SPRING COMPRESSOR

- 26897 - to replace mcpherson struts/springs directly in the car.

- 26943 - to replace mcpherson struts/springs outside the vehicle rugged steel profiles for higher stability.



No.	Capacity	Ø Compressed Spring	Compression Length	Weight	
26897	1 000 kg	100-200 mm	150 mm	24,5 kg	1
26943	1 000 kg	400 mm	210-570 mm	35 kg	1



WASTE OIL EXTRACTOR

- oil is drained from engine to collector through the dish
- collector is fitted with extraction equipment
- oil can be pumped from the collector with pressure air through a hose



No.	Cubage	Max.Pressure	Weight	
26954	90 l	0,5 MPa	28 kg	1



HYDRAULIC SHOP PRESS

No.	Range	Max.Capacity	Weight	
26940	0 - 610 mm	12 000 kg	43 kg	1
26941	0 - 880 mm	20 000 kg	75 kg	1

HYDRAULIC LONG RAM



No.	specification	Capacity	Min.Length (mm)	Max. Length (mm)	Weight	
26911	single pump	5 000 kg	620	1100	12 kg	2
26912	single pump	8 000 kg	620	1100	13 kg	2
26914	double pump	5 000 kg	620	1100	12 kg	2
26915	double pump	8 000 kg	620	1100	14 kg	2

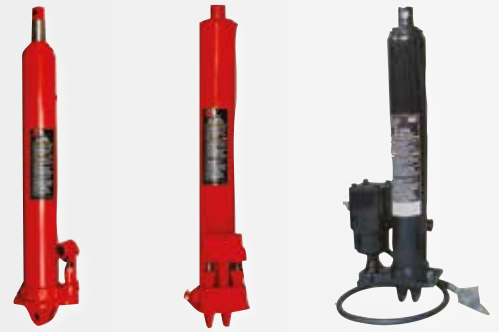

SPARE PARTS FOR SANDBLASTING CABINET

No.	specification	
26973	gloves	1
26974	nozzles	1
26975	foil 53,5 x 26 cm	1
26976	plexiglass 60 x 30 cm	1
26977	glass 60 x 30 cm	1

SANDBLASTING CABINET

No.	Air consumption	Outside dimensions	Inside dimensions	Max. Pressure	Weight	
26972	420-710 l/min.	1500 x 830 x 630 mm	600 x 840 x 630 mm	8 bar	38 kg	1



PARTS WASHER

· for common object washing (parts, accessories etc.)



No.	Tank capacity	Solvent capacity	Flow rate	Max. solvent temperature	Weight	
26961	90 l	45 l	10-12 l/min.	50°C	25 kg	1
26963	180l	150 l	20 l/min	50°C	42 kg	1



OILING CAN

No.	specification	
50020	300 ml	10



GREASE GUN

· bulk loading
· cartridge loading
· loading with dispenser

No.	specification	
50022	400 ml	20

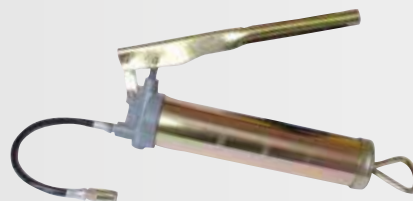

CANISTER PUMP

No.	
50017	10





OILING CAN

No.	specification	
50019	90 ml	1



BELT WRENCH

No.	specification	
50021	60 x 140 mm	6



FLEXIBLE FUNNEL

No.	specification	
50025	60 x 140 mm	50



HOSE WITH SELF-PRIMING VALVE

No.	length	∅	
50026	180 cm	15 mm	24



MAGNETIC TRAY

No.	specification	
26996	200 x 20 mm	1

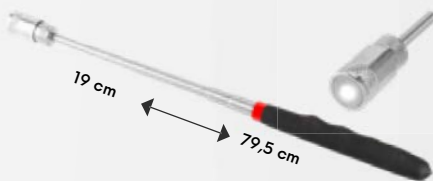

FESTA

MAGNETIC TELESCOPE PICK UPPER - LED LIGHT

No.	specification	
13294	3x LR44	6

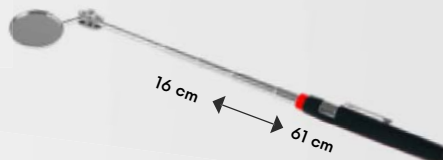

INSPECTION MIRROR TELESCOPE

No.	specification	
13290		20

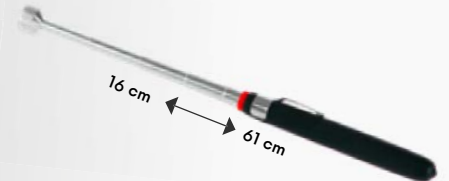

MAGNETIC TELESCOPE PICK UPPER

No.	specification	
13293		20



PICK UP TOOL FOR GARBAGE

· rotary 90°

No.	length	
61235	81 cm	12

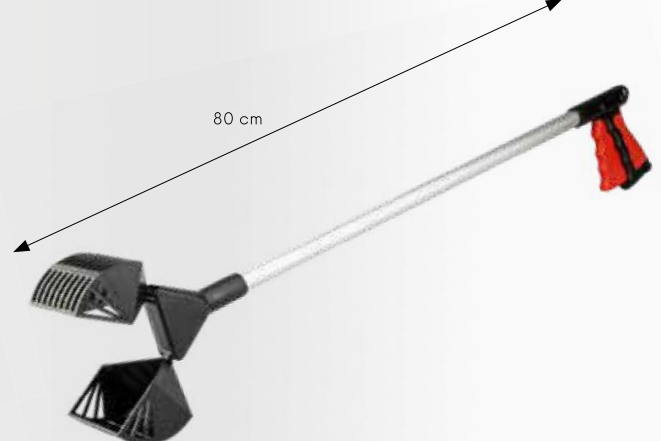

GARBAGE PLIERS

· max. 4 kg

No.		
61236		12

FESTA



NEW



80 lm



300 lm



200 lm



158 mm



301 mm



LED WORK LAMP

3xLED	80, 200, 300 lm	3W COB LED	USB TYPE C	Li-ion 3.7V 0.8Ah	120min
95g	0-180°	IK07	IP54		



No. 37647 Specifications 3,7V 800 mAh

1



FESTA
LED LIGHT



MOQ
12

No.	specification
37645	200 mm 3 x AAA 12

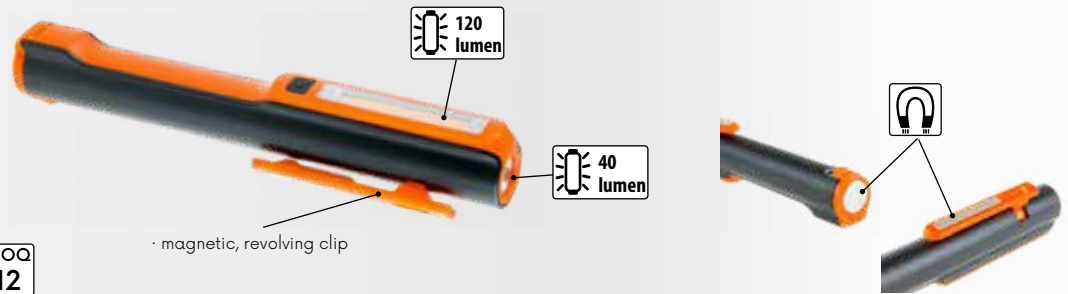

FESTA
LED HEAD LAMP

Weight	47 g
Light source	1 x 1 W white LED + 2x red LED
Battery:	3 x AAA
Dimensions	40 x 59 x 32 mm
Time of lighting	45 h
Aperture	120 lumen
Light distance	60 m (100% battery)
Type of lighting	4

· 5 positions

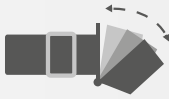

No.	specification
37641	120 lumen + red light 1

FESTA
LED LIGHT

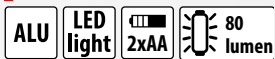

No.	specification
37630	185 mm 2 x AA 20



FESTA
LED LAMP



No.	specification
37650	12



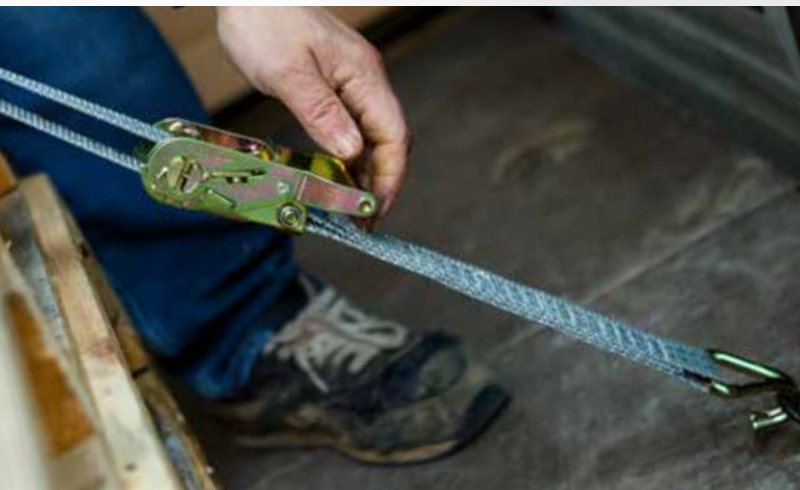

FESTA

TIE - DOWN STRAP, SELF-WINDING



2x



No.	width	length	load	pcs	
51070	18 mm	2 m	100 kg	2	12

FESTA

TIE - DOWN STRAP, SELF-WINDING



2x



No.	width	length	load	pcs	
51072	35 mm	4 m	500 kg	1	6

FESTA

TIE - DOWN STRAP



2x



No.	width	length	load	pcs	
51060	25 mm	5 m	750 kg	2	5

FESTA

TIE - DOWN STRAP



2x



No.	width	length	load	pcs	
51026	75 mm	5 m	3000 kg	1	4

FESTA

TIE - DOWN STRAP



2x



No.	width	length	load	pcs	
51017	50 mm	6 m	480 kg	2	5
51018	50 mm	6 m	480 kg	1	10

FESTA

TIE - DOWN STRAP, SELF-WINDING



No.	width	length	load	pcs	
51071	25 mm	3,5 m	300 kg	1	8



FESTA

TIE - DOWN STRAP



No.	width	length	load	pcs	
51040	25 mm	6 m	1000 kg	1	1
51041	35 mm	8 m	2000 kg	1	1
51042	35 mm	8 m	3000 kg	1	1
51043	50 mm	10 m	5000 kg	1	1



FESTA

TIE - DOWN STRAP



No.	width	length	load	pcs	
51065	50 mm	10 m	960 kg	1	6



FESTA

TIE - DOWN STRAP



No.	width	length	load	pcs	
51032	25 mm	5 m	500 kg	1	1

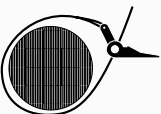



TIE - DOWN STRAP

No.	width	length	specification	pcs	
51022	25 mm	5 m	with hooks	40	
51023	50 mm	5 m	with hooks	12	

FESTA

TIE - DOWN STRAP

· softened EVA pad



No.	width	length	specification	pcs	
51046	38 mm	4 m		1	20



TIE - DOWN STRAP

No.	width	length	specification	pcs	
51030	50 mm	6 m	with hooks	20	
51034	50 mm	8 m	with hooks	10	

TIE - DOWN STRAP

2x



No.	width	length	specification	pcs	
51020	25 mm	2,5 m		2	100



TIE - DOWN STRAP

PE

No.	width	length	specification	pcs	
51045	25 mm	4 m		1	50

RUBBER STRAP WITH HOOPCS

2x



No.	length	Ø	specification	pcs	
51013	1,2 m	8 mm		2	1



RUBBER STRAP WITH HOOPCS

2x

No.	length	pcs	
51008	1 m	2	25



RUBBER STRAP WITH HOOPCS

No.	length	Ø	specification	pcs	
51009	1 m	10 mm		1	25



SET OF RUBBER STRAP WITH HOOPCS

8x

- 2 x 0,4 m
- 2 x 0,6 m
- 1 x 0,8 m
- 1 x 1,0 m

No.	length	Ø	specification	pcs	
51011	1 m	8 mm		8	10

RUBBER STRAP WITH HOOPCS

2x

No.	length	Ø	specification	pcs	
51001	80 cm	10 mm		2	50
51002	100 cm	10 mm		2	50
51003	150 cm	10 mm		2	50
51004	200 cm	10 mm		2	50



RUBBER STRAP WITH HOOPCS

2x

No.	length	Ø	specification	pcs	
51007	1 m	8 mm		2	25

RUBBER ROPE - SPIDER

No.	length	Ø	specification	pcs	
51010	80 cm	8 mm	8 hooks		50



RUBBER NET WITH HOOPCS



No.	length	width	
51015	80 cm	120 cm	20

RUBBER STRAP



No.	length	∅	
51036	20 m	8 mm	10
51037	20 m	10 mm	6

HOOPCS FOR RUBBER STRAPS



20x

No.	∅	
51038	10 mm	30

ALUMINIUM HOOK



ALU **MOQ 2**

No.	∅	length	
51200	6 mm	60 mm	2
51202	7 mm	70 mm	2
51201	8 mm	80 mm	2
51203	10 mm	100 mm	2

ROPE



No.	length	∅	
50915	5 m	8 mm	1
50916	25 m	8 mm	1
50917	25 m	10 mm	1
50918	25 m	12 mm	1
50919	25 m	14 mm	1

NYLON ROPE



No.	length	∅	
51055	80 m	1,5 mm	50
51056	50 m	2 mm	50
51057	20 m	4 mm	50



NYLON ROPE

No.	length	∅	
51050	50 m	8 mm	10
51051	50 m	10 mm	4



PP TWINE

No.	weight	
50905	80 g	80
50906	100 g	100
50907	200 g	50



PP TWINE

No.	weight	
50909	500 g (250 m)	1
50910	1000 g (500 m)	1
50911	5000 g (2500 m)	1



JUTE TWINE

No.	weight	
50900	80 g (61 m)	1
50901	100 g (76 m)	1
50902	200 g (153 m)	1



WAXED TWINE



No.	length	∅	
50920	50 m	1 mm	80

FIXING WIRE



1000x

No.	specification	
42365	1,25 100 mm	1
42366	1,25 125 mm	1
42367	1,25 140 mm	1
42368	1,25 160 mm	1



SPIRAL BINDER WIRE

No.	specification	
50052		12
50050		1



SPIRAL BINDER WIRE

No.	specification	
50051		2

BINDING TAPES

50x EN 50146 nylon

No.	length	width	
23875	120 mm	4,8 mm	1



BINDING TAPES

100x EN 50146 nylon

No.	length	width	
23880	100 mm	2,5 mm	1
23882	150 mm	2,5 mm	1
23884	200 mm	3,6 mm	1



BINDING TAPES WHITE

50x EN 50146 nylon

No.	length	width	
23850	120 mm	2,5 mm	1
23854	200 mm	3,6 mm	1
23856	250 mm	3,6 mm	1
23858	250 mm	4,8 mm	1
23860	300 mm	4,8 mm	1
23864	400 mm	4,8 mm	1
23866	500 mm	4,8 mm	1
23868	400 mm	7,6 mm	1
23870	500 mm	7,6 mm	1



BINDING TAPES BLACK

50x EN 50146 nylon

No.	length	width	
23810	120 mm	2,5 mm	1
23814	200 mm	3,6 mm	1
23816	250 mm	3,6 mm	1
23818	250 mm	4,8 mm	1
23820	300 mm	4,8 mm	1
23824	400 mm	4,8 mm	1
23826	500 mm	4,8 mm	1
23828	400 mm	7,6 mm	1
23830	500 mm	7,6 mm	1



BINDING TAPES

10x

No.	length	width	
23865	160 mm	7,5 mm	1



PACKAGING FOIL

No.	width	length	thickness	color	
38095	500 mm	600 m	8 µm	transparent	1
38097	100 mm	150 m	20 µm	transparent	1
38096	500 mm	200 m	23 µm	black	1

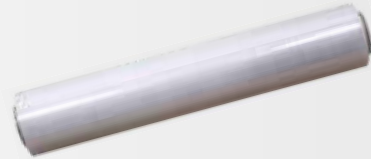

PE BAG BUILDING WASTE - TRANSPARENT

No.	width	length	thickness	pcs	
39194	500 mm	1100 mm	0,16 mm	100 1	10
39196	600 mm	1200 mm	0,16 mm	110 1	10
39198	700 mm	1100 mm	0,16 mm	120 1	10
39200	500 mm	1100 mm	0,20 mm	100 1	10
39202	600 mm	1200 mm	0,20 mm	110 1	10
39204	700 mm	1100 mm	0,20 mm	120 1	10



PE BAG BUILDING WASTE - BLACK

No.	width	length	thickness	pcs	
39195	500 mm	1100 mm	0,16 mm	100 1	10
39197	600 mm	1200 mm	0,16 mm	110 1	10
39199	700 mm	1100 mm	0,16 mm	120 1	10
39201	500 mm	1100 mm	0,20 mm	100 1	10
39203	600 mm	1200 mm	0,20 mm	110 1	10
39205	700 mm	1100 mm	0,20 mm	120 1	10



WASTE BAG

No.	width	length	thickness	pcs	
38060	700 mm	1100 mm	0,08 mm	10	1
38063	700 mm	1100 mm	0,10 mm	3	1
38065	700 mm	1100 mm	0,20 mm	3	1



WASTE BAG

No.	width	length	thickness	pcs	
38050	500 mm	600 mm	0,04 mm	25	1
38052	600 mm	800 mm	0,04 mm	25	1
38054	700 mm	1100 mm	0,04 mm	25	1



PE BAG BUILDING WASTE

5x

No.	width	length	thickness	
38055	1200 mm	1000 mm	0,08 mm	5





EXCAVATION WARNING TAPE

No.	width	length	
38955	22 cm	20 m	1
38956	22 cm	50 m	1



EXCAVATION WARNING TAPE

No.	width	length	
38957	22 cm	20 m	1
38958	22 cm	50 m	1



EXCAVATION WARNING TAPE

No.	width	length	
38959	22 cm	20 m	1
38960	22 cm	50 m	1



WARNING TAPE

No.	specification	length	
38944	ZÁKAZ VSTUPU, SK	80 mm 250 m	8
38945	VSTUP ZAKÁZÁN, CZ	80 mm 250 m	8



WARNING TAPE

No.	length	
38948	80 mm 250 m	8

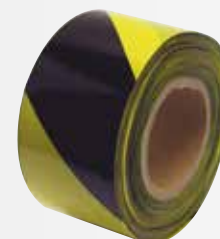

WARNING TAPE

No.	length	
38946	80 mm 250 m	8



WARNING TAPE SELF - ADHESIVE

No.	length	specification	
38947	48 mm 33 m	right	48
38961	48 mm 33 m	left	48



MARKING TAPE

No.	width	length	thickness	
38949	50 mm	50 m	0,15 mm	36

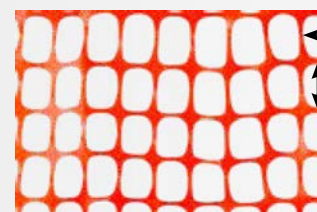

cca 3,5 cm
cca 6,5 cm

SAFETY MESH FENCING

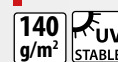

No.	specification	
42190	1,2 x 50 m HDPE 140g/m ²	1



PVC TAPES SET

5x

No.	width	length	thickness	
38931	19 mm	5 m	0,13 mm	100



PVC TAPE BLACK

No.	width	length	thickness	
38932	19 mm	10 m	0,13 mm	10



PVC TAPES SET

No.	width	length	thickness	
38925	19 mm	10 m	0,13 mm	10



PVC TAPE, BLACK

No.	width	length	thickness	
38968	19 mm	10 m	0,19 mm	10

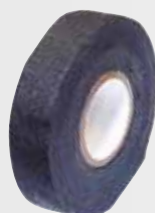

TEXTILE TAPE - BLACK

No.	width	length	
38927	19 mm	10 m	10

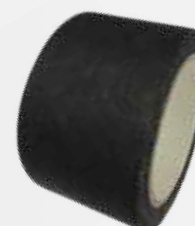

TEXTILE TAPE, KARPET

No.	width	length	
38980	48 mm	10 m	24
38981	48 mm	20 m	24



BOTH SIDES ADHESIVE TAPE WITH REINFORCEMENT

No.	width	length	
38924	50 mm	10 m	1
38964	50 mm	25 m	1

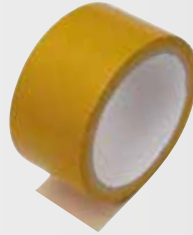

BOTH SIDES ADHESIVE TAPE



No.	width	length	
38929	50 mm	10 m	1
38966	50 mm	25 m	1



BOTH SIDES ADHESIVE TAPE



No.	width	length	
38990	19 mm	5 m	48
38991	25 mm	5 m	36



PROFESSIONAL REINFORCED WATERPROOF TAPE



No.	width	length	
38995	48 mm	25 m	24



REINFORCED WATERPROOF TAPE

No.	width	length	
38965	30 mm	10 m	1
38928	50 mm	10 m	72
38934	50 mm	45 m	24



DUCT TAPE, WATERPROOF



No.	width	length	
37275	48 mm	50 m	24



MASKING TAPE



No.	width	length	
37271	38 mm	20 m	24
37270	48 mm	20 m	24
37272	48 mm	50 m	24



PE MASKING TAPE FOR WINDOWS

for 30 days



No.	width	length	
37273	48 mm	50 m	24



PAPER MASKING TAPE



No.	width	length	
37263	38 mm	50 m	24
37264	48 mm	50 m	24



PVC TAPE ADHESIVE



No.	width	length	
37266	30 mm	33 m	60
37267	38 mm	33 m	48
37268	50 mm	33 m	36



PAPER MASKING TAPE



No.	width	length	
37255	19 mm	50 m	12
37256	25 mm	50 m	12
37257	30 mm	50 m	7
37258	38 mm	50 m	6
37259	50 mm	50 m	6



PACKAGING PVC TAPE



No.	width	length	
38942	50 mm	50 m	72



PLATED TAPE



No.	width	length	
38972	50 mm	50 m	1
38973	50 mm	100 m	1



ALU SELF ADHESIVE TAPE



No.	width	length	
38963	48 mm	10 m	1
38943	48 mm	45 m	24



ANTI - SLIP TAPE

No.	width	length	thickness	
37280	25 mm	15 m	0,8 mm	72
37281	50 mm	15m	0,8 mm	36



SELF WELDING TAPE

No.	width	length	
38930	19 mm	5 m	100



FIBERGLASS TAPE SELF ADHESIVE

No.	width	length	
38935	50 mm	20 m	60
38937	50 mm	45 m	36
38939	50 mm	90 m	24
38940	50 mm	153 m	24



FIBERGLASS FELT

No.	width	length	
38941	50 mm	25 m	40



TEFLON TAPE

No.	width	length	thickness	
38969	19 mm	15 m	0,2 mm	10



TEFLON TAPE

No.	width	length	thickness	
38933	12 mm	10 m	0,075 mm	10



TEFLON TAP

for water and gas installations

No.	width	length	
38926	2 mm	150 m	20

FESTA
THREAD SEALING CORD

· 160m
· -20°C ... +130°C
· max 16 bar



No.	Specifications	
38975		1



PACKING TAPE DISPENSER

No.		
38985		1



BINDING TAPE, VELCRO

No.	specification	
45471	12 mm x 5 m	1



FESTA
VELCRO TAPE 3 PCS

No.	width	length	
37295	20 mm	150 mm	1
37296	20 mm	200 mm	1
37297	20 mm	250 mm	1

TURN BUCKLE

DIN 1480 Zn



No.	specification	
50100	5 x 70 mm	10
50101	6 x 90 mm	10
50102	8 x 125 mm	10
50103	10 x 150 mm	10

No.	specification	
50104	12 x 200 mm	10
50106	16 x 230 mm	10
50108	20 x 220 mm	10

SNAP HOOK

DIN 5299 C Zn



No.	specification	
51204	4 mm	10
51205	5 mm	10
51206	6 mm	10
51207	7 mm	10
51208	8 mm	10

No.	specification	
51209	9 mm	10
51210	10 mm	10
51211	11 mm	10
51212	12 mm	10

RAPID QUICK LINK

Zn



No.	specification	
51241	4 mm	10
51242	5 mm	10
51243	6 mm	10
51244	7 mm	10

No.	specification	
51245	8 mm	10
51246	10 mm	10
51247	12 mm	10

S HOOK

Zn



No.	specification	
51271	3 mm	10
51272	4 mm	10
51273	5 mm	10
51274	6 mm	10

No.	specification	
51275	7 mm	10
51276	8 mm	10
51278	10 mm	10

EYE NUT

DIN 5820 Zn



No.	specification	
51320	6 mm	10
51321	8 mm	10
51322	10 mm	10
51323	12 mm	10

No.	specification	
51324	14 mm	10
51325	16 mm	10
51327	20 mm	10

EYE BOLT

DIN 5820 Zn



No.	specification	
51300	6 mm	10
51301	8 mm	10
51302	10 mm	10
51303	12 mm	10
51304	14 mm	10

No.	specification	
51305	16 mm	10
51306	18 mm	10
51307	20 mm	10
51308	22 mm	10



SWIVEL SNAP HOOK

Zn

No.	specification	
51220	53 mm	10
51221	67 mm	10
51222	76 mm	10



WIRE ROPE CLIP

Zn

No.	specification	
51225	3,8 mm	10
51226	4,5 mm	10
51227	6,0 mm	10



ROPE AND WIRE CONNECTOR

DIN 5685 C Zn

No.	specification	
51341	Ø 10 mm	10



WIRE ROPE CLIP

Zn

No.	specification	
51280	3 mm	10
51281	5 mm	10
51282	6 mm	10
51283	8 mm	10
51284	10 mm	10
51286	12 mm	10
51287	14 mm	10
51288	16 mm	10



WIRE ROPE THIMBLE

Zn

No.	specification	
51258	Ø 16 mm	10
51259	Ø 18 mm	10
51260	Ø 20 mm	10
51261	Ø 22 mm	10
51262	Ø 24 mm	10
51264	Ø 28 mm	10

CHAIN JACK

No.	Capacity	Min. height	Lift height	No. of chain block.	Chain Thickness	Weight	
26700	500 kg	280 mm	3 000 mm	1	6 mm	7,5 kg	1
26701	1 000 kg	300 mm	3 000 mm	1	6 mm	9 kg	1
26702	2 000 kg	380 mm	3 000 mm	2	6 mm	12 kg	1





TIGHTENING EQUIPMENT

No.	specification	
50035	2 t	6
50036	4 t	4



SHORT LINK CHAIN



DIN 5685 A Zn

No.	size of eye	length		No.	size of eye	length	
51402	2 x 10 mm	110 m	1	51406	6 x 24 mm	18 m	1
51403	3 x 16 mm	60 m	1	51407	7 x 50 mm	16 m	1
51404	4 x 21 mm	40 m	1	51408	8 x 32 mm	10 m	1
51405	5 x 23 mm	30 m	1	51410	10 x 39 mm	10 m	1



SHORT LINK CHAIN



DIN 5686 Zn

No.	Ø of material	length		No.	Ø of material	length	
51430	1,4 mm	150 m	1	51433	2,0 mm	118 m	1
51431	1,6 mm	150 m	1	51435	2,5 mm	70 m	1
51432	1,8 mm	130 m	1	51436	2,8 mm	50 m	1



LONG LINK CHAIN

DIN 5685 C Zn

No.	size of eye	length		No.	size of eye	length	
51412	2 x 12 mm	80 m	1	51416	6 x 43 mm	18 m	1
51413	3 x 26 mm	60 m	1	51417	7 x 50 mm	16 m	1
51414	4 x 32 mm	38 m	1	51418	8 x 54 mm	10 m	1
51415	5 x 35 mm	32 m	1	51420	10 x 65 mm	10 m	1



LINK CHAIN



No.	specification	
51450	6 mm 25 m red-white	1



HAND WINCH WITH WIRE ROPE AND HOOK

Zn

No.	load capacity	length	
26720	300 kg	8 m	1
26705	450 kg	8 m	1
26721	500 kg	8 m	1
26722	800 kg	8 m	1
26706	900 kg	8 m	1
26707	1350 kg	8 m	1



STAND FOR ROPES, STAND FOR CHAINS

No.	specification	
51196	Promotional stand for chains staffed	10
51197	Promotional stand for ropes staffed	10
51198	Promotional stand for chains	10
51199	Promotional stand for ropes	10

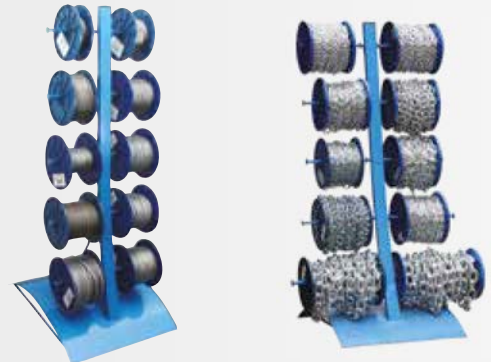

WIRE ROPE ZN COATED

Zn

No.	rope diameter	length	
51100	Ø 1 mm	500 m	1
51102	Ø 1,5 mm	500 m	1
51103	Ø 2 mm	200 m	1
51104	Ø 3 mm	200 m	1
51105	Ø 4 mm	100 m	1
51106	Ø 5 mm	75 m	1
51107	Ø 6 mm	75 m	1
51130	Ø 8 mm	75 m	1
51131	Ø 10 mm	50 m	1
51132	Ø 12 mm	50 m	1



WIRE ROPE ZN COATED IN PVC COVER

Zn

No.	rope diameter	length	
51108	Ø 2/3 mm	200 m	1
51109	Ø 3/4 mm	100 m	1
51110	Ø 4/5 mm	75 m	1
51111	Ø 5/6 mm	50 m	1



STAINLESS ROPE

INOX

No.	rope diameter	length	
51120	Ø 1 mm	300 m	1
51121	Ø 1,2 mm	300 m	1
51122	Ø 1,5 mm	300 m	1
51123	Ø 2 mm	200 m	1
51124	Ø 3 mm	200 m	1
51125	Ø 4 mm	100 m	1
51126	Ø 5 mm	75 m	1
51127	Ø 6 mm	75 m	1



THREAD ROD

DIN 975 **Zn**

4.8 · strength class

No.	specification	
55040	M 4 1 m	200
55050	M 5 1 m	150
55060	M 6 1 m	100
55080	M 8 1 m	50
55100	M 10 1 m	20
55120	M 12 1 m	20
55140	M 14 1 m	15
55160	M 16 1 m	15
55180	M 18 1 m	10
55200	M 20 1 m	10
55220	M 22 1 m	5
55240	M 24 1 m	5
55300	M 30 1 m	5



THREAD ROD STAINLESS

DIN 976 **INOX** **4.8** · strength class

No.	specification	
55315	M 12 1 m	20
55316	M 14 1 m	15
55317	M 16 1 m	15
55318	M 18 1 m	10
55319	M 20 1 m	10



before after



FESTA EDGE CLEANER

Ø 3 - 19 mm

1/4"

No.	Specification	
16321		5

THREAD ROD

DIN 975 **4.8** · strength class

No.	specification	
55051	M 5 1 m	150
55181	M 18 1 m	10
55201	M 20 1 m	10
55221	M 22 1 m	5



NUT

DIN 934 **Zn**

4.8 · strength class

No.	specification	
55350	M 4 100 pcs	1
55351	M 5 100 pcs	1
55352	M 6 100 pcs	1
55353	M 8 100 pcs	1
55354	M 10 100 pcs	1
55355	M 12 100 pcs	1
55356	M 14 100 pcs	1
55357	M 16 100 pcs	1
55358	M 18 100 pcs	1
55359	M 20 10 pcs	1
55360	M 22 10 pcs	1
55361	M 24 10 pcs	1
55362	M 30 10 pcs	1



WASHER

DIN 440R **Zn**



No.	specification	
55331	M 5 100 pcs	1
55332	M 6 100 pcs	1
55333	M 8 100 pcs	1
55334	M 10 100 pcs	1
55335	M 12 100 pcs	1
55336	M 14 100 pcs	1
55337	M 16 100 pcs	1
55339	M 20 10 pcs	1
55340	M 22 10 pcs	1
55341	M 24 10 pcs	1
55342	M 30 10 pcs	1



FESTA ORGANISER BOX



No.	specifications	
55650	375 x 290 x 67 mm	1



WOOD SCREW

2000x

No.	specification	
55640	2000 pcs	1



pcs	content
350	3,0 x 16 mm
280	3,0 x 20 mm
220	3,0 x 25 mm
250	3,5 x 20 mm
240	3,5 x 25 mm
180	3,5 x 3, mm
280	4,0 x 16 mm
80	4,0 x 30 mm
40	4,0 x 40 mm
30	4,0 x 50 mm
25	5,0 x 50 mm
25	5,0 x 60 mm

WOOD SCREWS AND WALL DOWELS IN BOX

wood screws	
pcs	content
40	3,5 x 30 mm
25	4,0 x 40 mm
12	5,0 x 50 mm
8	6,0 x 60 mm

wall dowels	
pcs	content
40	5 x 25 mm
25	6 x 30 mm
12	8 x 40 mm
8	10 x 50 mm

170x

No.	specification	
55645		1



WOOD SCREWS IN BOX

pcs	content
60	3,0 x 12 mm
50	3,0 x 16 mm
40	3,0 x 20 mm
50	3,5 x 20 mm
40	3,5 x 30 mm
25	4,0 x 30 mm
20	4,0 x 40 mm
15	5,0 x 50 mm
10	5,0 x 60 mm

310x

No.	specification	
55642		1





SAFETY GOOGLES

CE EN 166	No.	specification	
	50510		10



PROTECTIVE HEADPHONES

CE EN 352		27 dB	
No.	specification		
50563		1	



PROTECTIVE HEADPHONES

CE EN 352		27 dB	
No.	specification		
50564		1	



SAFETY GOOGLES

CE EN 166	No.	specification	
	50514		10



SAFETY FACE SHIELD

CE EN 166	No.	specification	
	50556		10



PROTECTIVE SHIELD WITH GRID

CE EN 1731	No.	specification	
	50562		10



SAFETY GOOGLES

adjustable length of temples

CE EN 166	No.	specification	
	50511		12



EARPLUGS

No.	specification	
50560		100



EARPLUGS WITH CORD

No.	specification	
50559		100



SAFETY GOOGLES

CE EN 170	No.	specification	
	50512	dark	12



SAFETY HELMET CLIMAX

CE EN 397	MADE IN EU	No.	specification	
		50550	blue	30
		50551	red	30
		50553	white	30
		50554	yellow	30



REFLECTIVE VEST

CE EN 20471	No.	specification	
	50570	orange	100
	50571	yellow	100

SAFETY GOOGLES

CE EN 166	No.	specification	
	50513		1



KNEELING CREEPER

No.	specification	
37135		1



FESTA
KNEE PROTECTOR

No.	specification	
37145	gel	8



FESTA
KNEE PROTECTOR

No.	specification	
37140	gel	12



FESTA
KNEE PROTECTOR

No.	specification	
37144	gel	12



FESTA
KNEE PROTECTOR

No.	specification	
37143		12



FESTA
KNEE PROTECTOR

No.	specification	
37142	comfort	20



KNEE PROTECTOR

No.	specification	
37139	neopren	10



KNEE PROTECTOR

No.	specification	
37141		6





LEATHER GLOVES, REINFORCED

· With lining in palm



No.	specification	
50518	size 11"	12



LEATHER GLOVES, REINFORCED

· With lining in palm



No.	specification	
50519	size 10,5"	12



LEATHER GLOVES



No.	specification	
50520	size 10,5"	12



COTTON GLOVES WITH DOTS

No.	specification	
50524	size 10"	12



COTTON GLOVE, DIPPED IN PVC



No.	specification	
50525	size 10" - length 35 cm	12



POLYESTER GLOVES WITH PVC DOTS

· With PVC dots

No.	specification	
50526	size 10"	12



COTTON GLOVE, DIPPED IN LATEX



No.	specification	
50522	size 10"	12



NYLON GLOVES WITH NITRILE COATING



No.	specification	
50533	size 10"	12



NYLON GLOVES WITH LATEX FOAM COATING



No.	specification	
50535	size 8"	12
50536	size 9"	12
50537	size 10"	12



NYLON GLOVES WITH NITRILE FOAM COATING

· With PVC dots



No.	specification	
50539	size 10"	12



CRYL WINTER GLOVES WITH LATEX COATING



No.	specification	
50529	size 10"	12



GLOVES FOR GARDENING

No.	specification	
50557	size 7"	12
50558	size 8"	12
50549	size 9"	12



COTTON GLOVES

· With PVC dots

No.	specification	
50531	size 9"	12



GOATSKIN LEATHER GLOVES



No.	specification	
50541	size 9"	12
50542	size 10"	12



GLOVE NYLON - PIGSKIN LEATHER



No.	specification	
50544	size 10"	12



NYLON GLOVE, DIPPED IN POLYURETAN



No.	specification	
50527	size 10"	12



LEATHER GLOVES FOR WELDING



No.	specification	
50540	size 11"	12



DISPOSABLE VINYL GLOVES

· clear, powder free



No.	specification	
50532	size 9"	100



RESPIRATOR



No.	specification	
50500	FFP2 without valve	30



RESPIRATOR



No.	specification	
50503	FFP2 with valve	20



SAFETY OVERALLS WITH HOOD

No.	specification	
50585	size M	1
50586	size L	1
50587	size XL	1
50588	size XXL	1

APRON FOR WELDING



No.	specification	
50555	leather	1





FESTA
BAG FOR TOOL WITH METAL HANDEL

No.	height	length	depth	
37331	280 mm	490 mm	230 mm	2



FESTA
BAG

No.	width	height	depth	
37332	480 mm	290 mm	250 mm	1

FESTA
BAG

No.	width	height	depth	
37330	610 mm	400 mm	270 mm	5



FESTA
CASE FOR TOOL

· reinforced pockets

No.	specification	
37325	10	10

FESTA
CASE FOR TOOL

· reinforced pockets

No.	specification	
37326	12	12

FESTA
BELT

No.	specification	
37328	145 cm	20



FESTA

MOUNTING BELT

· 14 pockets + eye

No.	length	width	
37311	120 cm	6 cm	1



FESTA

NYLON BELT

No.	length	width	
37310	120 cm	6 cm	1



FESTA

CASE FOR TOOLS

· 8 pockets

No.	width	height	
37320	300 mm	250 mm	1



FESTA

CASE FOR TOOLS

· 4 pockets

No.	width	height	
37321	350 mm	300 mm	1



FESTA

WORKING JACKET

No.	specification	
37350		20



FESTA

TOOL BELT LEATHER



No.	specification	
37302	6 pockets	50
37303	11 pockets	25



TOOL BELT LEATHER



No.	specification	
37300	6 pockets	50
37301	11 pockets	25



FESTA



LEATHER BAG PROFESIONAL



No.	height	length	depth	
37342	270 mm	430 mm	180 mm	1



ELECTRICIAN LEATHER BAG



No.	height	length	depth	
37341	260 mm	430 mm	200 mm	1



LEATHER BAG WITH REINFORCED BOTTOM



No.	height	length	depth	
37340	240 mm	430 mm	150 mm	1



CRAFTMAN LEATHER BAG WITH STRAP

No.	height	length	depth	
37344	250 mm	300 mm	130 mm	1



BAG WITH REINFORCED BOTTOM

No.	height	length	depth	
37343	240 mm	430 mm	150 mm	1



ELECTRICIAN BAG

No.	height	length	depth	
37345	270 mm	430 mm	180 mm	1

TOOL BELT - LEATHER



No.	specification
37308	20



TOOL BELT - LEATHER



No.	specification
37309	20





FESTA

BRASS CYLINDER LOCK



No.	specification	
23001	65 mm · 175 g	10



BRASS COATED LOCK



No.	specification	
23000	65 mm · 75 g	15



FESTA

PADLOCK POWER



No.	specification	
23261	25 mm	6
23262	32 mm	12
23263	38 mm	6
23264	45 mm	6
23265	52 mm	12
23266	63 mm	6



FESTA

PADLOCK POWER



No.	specification	
23125	25 mm	12
23130	30 mm	12
23135	35 mm	12
23140	40 mm	12
23150	50 mm	12
23160	60 mm	12



FESTA

PADLOCK BRASS, PVC COATED



No.	specification	
23310	30 mm	10
23311	40 mm	10
23312	50 mm	6



FESTA

PADLOCK POWER EXTENDED



No.	specification	
23211	25 mm	12
23212	32 mm	12
23213	38 mm	6
23214	45 mm	6
23215	52 mm	6

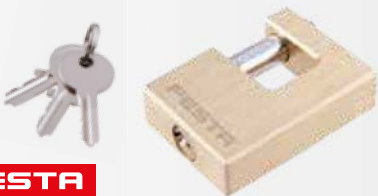

FESTA

PADLOCK POWER



No.	specification	
23274	60 mm	6
23275	70 mm	12



PADLOCK POWER



No.	specification	
23220	25 mm	6
23225	30 mm	6
23232	32 mm	6
23240	40 mm	6
23250	50 mm	6
23260	60 mm	6



PADLOCK BRASS COATED



No.	specification	
23020	20 mm	12
23025	25 mm	12
23030	30 mm	12
23035	35 mm	12
23040	40 mm	12
23050	50 mm	12
23060	60 mm	12





PADLOCK BRASS COATED EXTENDED



No.	specification	
23070	40 mm	12

PADLOCK POWER



No.	specification	
23010	50 mm	6

PADLOCK POWER



No.	specification	
23005	40 mm	6
23006	50 mm	6



FESTA

BICYCLE LOCK WITH NUMBER CODE



No.	specification	
23288	120 cm x Ø 10 mm	1



FESTA

BICYCLE LOCK WITH NUMBER CODE



No.	specification	
23287	65 cm x Ø 10 mm	1



FESTA

BICYCLE LOCK



No.	specification	
23290	120 cm x Ø 8 mm	1
23291	150 cm x Ø 8 mm	1
23292	180 cm x Ø 8 mm	1

BICYCLE LOCK



No.	specification	
23282	55 cm x Ø 8 mm	50
23284	65 cm x Ø 8 mm	50



LOCK WITH NUMBER CODE



No.	specification	
23281		20





FESTA

SECURITY ELECTRONIC LOCK BOX



- Lock type: electronic, mechanical
- Security key
- Dimensions 350x250x250mm
- Weight 10kg



No.	specification	
23270		1

FESTA

TAGS FOR KEY



- strong circle



No.		
23391		50

TAGS FOR KEY



No.		
23390		1



CASH BOX



No.	width	deep	height	
70120	125 mm	95 mm	60 mm	1



LATCH

No.	specification	
51514	100 mm	25
51515	120 mm	25
51516	140 mm	25
51517	160 mm	25



PLUG

No.	specification	
51510	100 mm	12
51511	120 mm	12
51512	140 mm	12
51513	160 mm	12



BOX FOR KEYS



No.	specification	
70140	250 x 180 x 80 mm - for 48 keys	12
70141	300 x 230 x 90 mm - for 90 keys	8

CASH BOX



No.	width	deep	height	
70122	200 mm	160 mm	90 mm	20



CASH BOX



No.	width	deep	height	
70123	250 mm	180 mm	90 mm	16



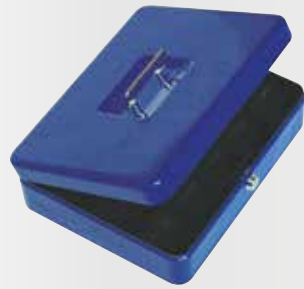

CASH BOX



No.	width	deep	height	
70124	300 mm	240 mm	90 mm	10



CASH BOX



No.	width	deep	height	
70125	370 mm	280 mm	90 mm	8



MAILBOX



No.	color	width	height	deep	
70101	white	290 mm	360 mm	105 mm	5
70100	brown	290 mm	360 mm	105 mm	5



MAILBOX



No.	color	width	height	deep	
70102	white	310 mm	260 mm	90 mm	10
70103	brown	310 mm	260 mm	90 mm	10



MAILBOX



No.	color	width	height	deep	
70105	brown	310 mm	360 mm	90 mm	5



MAILBOX



No.	color	width	deep	height	
70108	white	370 mm	134 mm	364 mm	5



MAILBOX



No.	material	width	deep	height	
70107	stainless	360 mm	100 mm	520 mm	6



MAILBOX



No.	material	width	deep	height	
70106	stainless	360 mm	100 mm	360 mm	5



MAILBOX



No.	material	width	deep	height	
70109	stainless	310 mm	90 mm	260 mm	6



MAILBOX



No.	material	width	deep	height	
70110	stainless	310 mm	90 mm	360 mm	6

STEELYARD ANALOG

No.	max.		
24260	50 kg	10	



STEELYARD

No.	max.	
24212	12,5 kg	12
24225	25 kg	6
24250	50 kg	6
24255	100 kg	6
24258	150 kg	6



TWEEZERS WITH LED LIGHT

No.	specification	
50005	95 mm	8

INOX 3x LR41



TWEEZER SET STAINLESS

No.	specification	
50004		1

INOX 2x



MOUSETRAP

No.	specification	
70221	90 x 45 mm wooden	1

2x



MOUSETRAP

No.	specification	
70220	97 x 47 mm plastic	48

2x



DRAIN CLEANER

can be used with drilling-machine

No.	length	∅	
50014	6 m	6 mm	6



∅ 15 mm

DRAIN CLEANER

No.	length	
50010	3 m	10
50011	5 m	5
50012	10 m	3
50013	15 m	4



∅ 20mm

∅ 10mm



DRAIN CLEANER

No.	length	∅	
50009	3 m	5 mm	40

∅ 5mm



SUCTION PUMP

No.	length	∅	
50015	385 mm	65 mm	30



DRAW TAPE

No.	length	∅	
51181	8 m	5 mm	25
51182	10 m	5 mm	25





244

TROWELS
AND PUTTY KNIVES

250

DIPPERS



254

BAR TROWELS
AND SANDING TROWELS

255

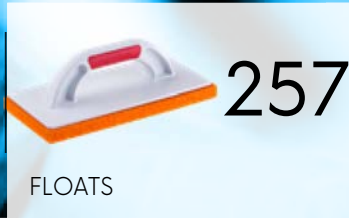
FLOATS AND
MASSON STAFFS

257

FLOATS



261

MIXERS



266

BUILDING MIXERS



269

CONSTRUCTION
DEBRIS CHUTE

269

WHEEL BARROWS



270

SCREEDING
LEVELS HORIZONTAL

272

FLOOR TILE
BREAKERS, CURB HOLDERS

274

TILE CUTTING MACHINES



277

TOOLS FOR
WORK WITH TILES

280

LEVELING ACCESSORIES

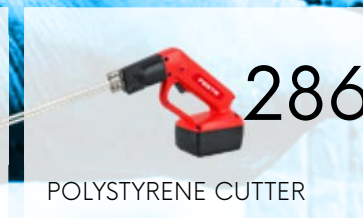

286

POLYSTYRENE CUTTER



292

DRYWALL TOOLS



294

PB HEATERS AND
PRESSURE REGULATORS

296

MASON TUBS



297

CAULKING GUNS



299

PU FOAM GUNS



300

PAINTER TOOLS



305

TARPAULINS



306

LADDERS



307

CHIMNEY DOORS
AND ADJUSTABLE PROPS

BUILDING TOOLS

242 - 307





FESTA

FESTA

STAINLESS
TROWEL
280 X 130 MM

· rubber handle



No.	specification	
31140	straight	10

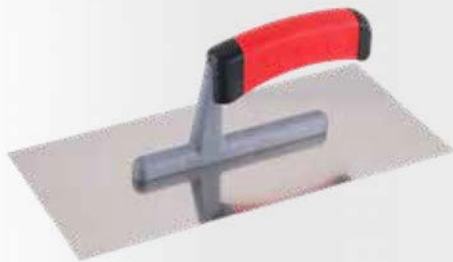

FESTA

STAINLESS
TROWEL
280 X 130 MM

· rubber handle



No.	specification	
31148	straight with rounded corners	10



FESTA

NOTCHED
STAINLESS
TROWEL
280 X 130 MM

· rubber handle



No.	specification	
31146	Ø 16	10



FESTA

NOTCHED
STAINLESS
TROWEL
280 X 130 MM

· rubber handle



No.	specification	
31141	e 4	10
31142	e 6	10
31143	e 8	10

No.	specification	
31144	e 10	10
31145	e 12	10

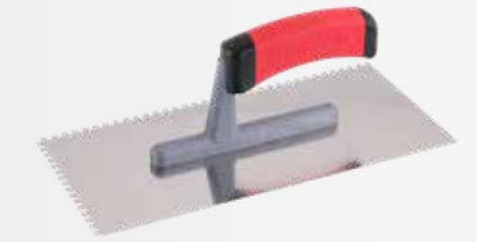

FESTA

NOTCHED
STAINLESS
TROWEL
280 X 130 MM



No.	specification	
31101	e 4	10
31111	e 6	10
31121	e 8	10

No.	specification	
31131	e 10	10
31132	e 12	10



FESTA

STAINLESS
TROWEL
280 X 130 MM



No.	specification	
31091	straight	10



FESTA

STAINLESS
TROWEL
280 X 130 MM



No.	specification	
31011	straight	10

FESTA

NOTCHED
STAINLESS
TROWEL
280 X 130 MM



No.	specification		No.	specification	
31021	e 4	10	31051	e 10	10
31031	e 6	10	31053	e 12	10
31041	e 8	10			

STAINLESS
TROWEL
270 X 125 MM



No.	specification	
31005	straight	25

NOTCHED
STAINLESS
TROWEL
270 X 125 MM



No.	specification		No.	specification	
31006	e 4	24	31008	e 8	24
31007	e 6	24	31009	e 10	24

FESTA

STAINLESS
TROWEL
360 X 130 MM



No.	specification	
31151	straight	10

FESTA

STAINLESS
TROWEL
360 X 130 MM



No.	specification	
31150	straight	10

FESTA

STAINLESS
TROWEL
480 X 130 MM



No.	specification	
31082	straight	10

FESTA

STAINLESS
TROWEL
680 X 130 MM



No.	specification	
31155	straight	10

FESTA

NOTCHED
STAINLESS
TROWEL
500 X 130 MM



No.	specification	
31052	e 4	10
31061	e 6	10
31062	e 8	10
31071	e 10	10
31072	e 12	10

FESTA

STAINLESS
TROWEL
500 X 130 MM



No.	specification	
31081	straight	10



FESTASTAINLESS STEEL
TROWEL

INOX · rubber handle

No.	specification	
31232	120 mm	10
31233	140 mm	10

**FESTA**STAINLESS STEEL
TROWEL

INOX

No.	specification	
31220	120 x 80 mm	10
31221	140 x 80 mm	10

**FESTA**STAINLESS STEEL
TROWEL

INOX · rubber handle

No.	specification	
31334	160 x 100 mm	10

**FESTA**STAINLESS STEEL
TROWEL

INOX

No.	specification	
31343	160 x 100 mm	10

**FESTA**STAINLESS STEEL
TROWEL

INOX · rubber handle

No.	specification	
31360	40 mm	10
31380	60 mm	10
31390	80 mm	10

**FESTA**STAINLESS STEEL
TROWEL

INOX

No.	specification	
31362	40 mm	10
31382	60 mm	10



No.	specification	
31392	80 mm	10
31402	100 mm	10
31404	120 mm	10

FESTACAT TONGUE
STAINLESS STEEL TROWEL

INOX · rubber handle

No.	specification	
31330	140 x 50 mm	10
31340	160 x 60 mm	10

**FESTA**CAT TONGUE
STAINLESS STEEL TROWEL

INOX

No.	specification	
31332	140 x 50 mm	10
31341	160 x 60 mm	10

**FESTA**STAINLESS STEEL TROWEL
FOR INNER CORNER

INOX · rubber handle

No.	specification	
31280	80 x 60 x 60 mm	10

**FESTA**STAINLESS STEEL TROWEL
FOR INNER CORNER

INOX

No.	specification	
31281	80 x 60 x 60 mm	10

**FESTA**STAINLESS STEEL TROWEL
FOR OUTER CORNER

INOX · rubber handle

No.	specification	
31270	80 x 60 x 60 mm	10

**FESTA**STAINLESS STEEL TROWEL
FOR OUTER CORNER

INOX

No.	specification	
31271	80 x 60 x 60 mm	10



FESTA

STAINLESS STEEL TROWEL

INOX · rubber handle

No.	specification	
31320	140 x 75 mm	10



FESTA

STAINLESS STEEL TROWEL

INOX

No.	specification	
31322	140 x 75 mm	10



FESTA

NOTCHED STAINLESS STEEL TROWEL

INOX

No.	specification	
31218	180 mm e 6	12



FESTA

STAINLESS STEEL PUTTY KNIFE

· rubber handle

INOX

No.	specification	
31510	40 mm	10
31511	60 mm	10
31512	80 mm	10



FESTA

STAINLESS STEEL SCRAPER

· rubber handle
· thick blade

INOX

No.	specification	
32173	75 mm	10



FESTA

STAINLESS STEEL SCRAPER

· recommended pole handle 52010
· thick blade

INOX

No.	specification	
32170	100 mm	12



FESTA

STAINLESS STEEL PUTTY KNIFE WITH BIT

· rubber handle

INOX

No.	specification	
31455	150 mm	12
31456	200 mm	12



FESTA

CORNER PUTTY KNIFE

INOX

No.	specifications	
31517		10



FESTA

STAINLESS STEEL PUTTY KNIFE

· rubber handle

INOX

No.	specification	
31505	200 mm	5
31506	250 mm	5
31507	300 mm	5



**FESTA****STAINLESS STEEL SCRAPER**

· thick blade

INOX

No.	width	length	
32174	100 mm	500 mm	1

FESTA**STAINLESS STEEL PUTTY KNIFE****INOX**

R.sz.	leírás	
31461	40 mm	12
31471	60 mm	12
31481	80 mm	12
31491	100 mm	12
31467	120 mm	12
31468	140 mm	12

**FESTA****STAINLESS STEEL PUTTY KNIFE****INOX**

No.	specification	
31498	150 mm	12
31499	200 mm	12
31500	100 mm	12

**STAINLESS STEEL PUTTY KNIFE****INOX****MADE IN EU**

No.	specification	
31493	40 mm	20
31494	60 mm	20
31495	80 mm	20
31496	100 mm	20

**PUTTY KNIFE**

R.sz.	leírás	
32176	30 mm	12
32186	40 mm	12
32196	50 mm	12
32206	60 mm	12
32216	80 mm	12
32226	100 mm	12
32234	125 mm	12

**SET OF PUTTY KNIVES****3x**

No.	specification	
32240	30, 50, 80 mm	10

**FESTA****PUTTY KNIFE**

No.	specification		No.	specification	
32161	30 mm	10	32171	90 mm	10
32162	40 mm	10	32166	100 mm	10
32163	50 mm	10	32172	110 mm	10
32164	60 mm	10	32167	120 mm	10
32169	70 mm	10	32168	140 mm	10
32165	80 mm	10			

**SKIM COAT ROLLER**

- handle 180 mm - 52630
- handle 250 mm - 52625
- handle 52010, 52011, 52012, 52020, 52030



No.	Specification			
52611	250 mm	Ø 8 mm	Ø 48 mm	50
52612	180 mm	Ø 8 mm	Ø 48 mm	10

FESTA

STAINLESS STEEL
PUTTY KNIFE

INOX

R.s.	leírás	
31555	35 cm	1
31556	45 cm	1
31557	60 cm	1
31558	80 cm	1
31559	100 cm	1



FESTA

TELESCOPIC HANDLE

thread for 31610, 34203

No.	Specification	
52011	88 - 140 cm	1

FESTA

STAINLESS STEEL
PUTTY KNIFE
HOLDER

· for 31555 - 31559
· handle 52010, 52011, 52012, 52020, 52030

No.	Specification	
31610		1



STAINLESS STEEL
SPATULA WITH
REINFORCEMENT

INOX

MADE IN
EU

No.	specification	
31520	400 mm	1
31521	500 mm	
31522	600 mm	



handle 61254



STAINLESS STEEL SPATULAS
WITH REINFORCEMENT ACCESSORIES

No.	specification	
31523	ALU holder	1
31524	plastic holder	1

FACADE
STAINLESS STEEL
PUTTY KNIFE

INOX

No.	specification	
31552	400 mm	10
31553	600 mm	10



STAINLESS STEEL
PUTTY KNIFE

INOX
MADE IN
EU

No.	specification	
31541	250 mm	1
31551	250 mm narrow	1



STEEL TROWEL

No.	specification	
32062	280 x 160 mm	10
32060	500 x 140 mm	5

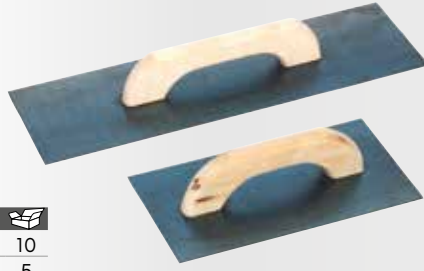

STEEL TROWEL

No.	specification	
32064	500 x 90 mm	5
32066	550 x 140 mm	5



PLASTERERS TROWEL

No.	specification	
32015	160 x 130 mm	10
32014	180 x 130 mm	10
32016	200 x 140 mm	10



PLASTERERS TROWEL

No.	specification	
32001	160 x 110 mm	10
32002	160 x 130 mm	10
32003	180 x 130 mm	10
32013	200 x 140 mm	10



PLASTERERS TROWEL

No.	specification	
32018	160 x 110 mm	10



PLASTERERS TROWEL

No.	specification	
32024	140 x 80 mm	12



CAT TONGUE TROWEL

No.	specification	
32020	140 x 65 mm	12
32021	140 x 40 mm	12



PLASTERERS TROWEL

No.	specification	
32026	140 x 85 mm	12



FESTA

DIPPER STAINLESS STEEL

INOX		
No.	specification	
32285	Ø 180 mm	1



FESTA

DIPPER ZN COATED

Zn		
No.	specification	
32265	Ø 180 mm	10





FESTA

DIPPER

No.	specification	
32273	Ø 160 mm	10
32283	Ø 180 mm	10
32293	Ø 215 mm	10



DIPPER PLASTIC

 		
No.	specification	
32270	Ø 160 mm	1



DIPPER

· recommended pole handle 61215

No.	specification	
32302	Ø 180 mm	1
32313	Ø 215 mm	1
32301	Ø 235 mm	1



DIPPER FOR SHOVEL BUTT

· recommended pole handle 61200, 61201

No.	specification	
32268	Ø 215 mm	1
32269	Ø 235 mm	1
32296	Ø 215 mm	1



CONCRETE MIXER

No.	specification	
60100	concrete mixer 295 x 150 mm	24
61169	concrete mixer with butt 160 cm	3
61218	butt 160 cm	5



DIPPER WITH BUTT

No.	specification	
32295	Ø 180 mm length of butt 160 cm	3
32297	Ø 215 mm length of butt 160 cm	3
32298	Ø 235 mm length of butt 160 cm	3



BUILDING CARVER FOR AERATED CONCRETE

No.	specification	
32037	600 mm	1



ANGLE FOR AERATED CONCRETE

No.	specification	
32038	270 x 270 x 270 mm	1



TROWEL FOR AERATED CONCRETE

No.	specification	
32089	150 mm	1



FESTA
FLAT CHISEL

CrV	No.	specification	the tip width	
	19406	300 mm	25 mm	5
19407	400 mm	30 mm	5	



FESTA
POINT CHISEL

CrV	No.	specification	
	19408	250 mm	5
19409	350 mm	5	



FESTA
FLAT CHISEL

CrV	No.	specification	the tip width	
	19460	300 mm	25 mm	5
19470	400 mm	30 mm	5	



POINT CHISEL

No.	specification	
19400	250 mm	5
19403	350 mm	6



FLAT CHISEL

No.	specification	the tip width	
19401	250 mm	19 mm	6
19404	350 mm	22 mm	6



FLAT CHISEL

No.	specification	the tip width	
19402	250 mm	50 mm	2
19405	350 mm	50 mm	6



NEW



FESTA

MULTIFUNCTION
SCRAPER

INOX

No.	Specifications
31519	75 mm

STAINLESS STEEL
PAINT SCRAPER

INOX

No.	specification	
31497	63 x 195 mm	12



FESTA

STAINLESS STEEL
WALLPAPER KNIFE

INOX

No.	specification	
31503	150 mm	12



PAINT SCRAPER

MADE IN
EU

No.	specification	
31501	100 mm	30
31502	spare edge	1

DRYWALL
PLASTIC PUTTY KNIFE

PLASTIC

No.	specification	
34308	50 mm	20
34307	80 mm	12
34306	100 mm	10
34305	150 mm	12



SANDING MESH HOLDER

No.	specification	
34301	230 x 105 mm	1
34304	235 x 80 mm	1



FESTA

SANDING MESH HOLDER

No.	specification	
34200	210 x 115 mm	30
34201	240 x 105 mm	50
34202	240 x 80 mm	50



SANDING MESH HOLDER

· handle 52030

ALU

No.	specification	
34203	230 x 80 mm aluminium	1
52030	telescopic pole	12

SANDING
MESH
SET

10x

No.	specification	
34271	115 x 290 mm P120	80
34272	115 x 290 mm P100	80
34273	115 x 290 mm P80	80
34274	93 x 290 mm P120	80
34275	93 x 290 mm P100	80
34276	93 x 290 mm P80	80

SANDING
MESH
SET

3x

No.	specification	
34280	115 x 290 mm P120	20
34281	115 x 290 mm P100	20
34282	115 x 290 mm P80	20
34283	93 x 290 mm P120	20
34284	93 x 290 mm P100	20
34285	93 x 290 mm P80	20



FESTA

SET OF PUTTY KNIVES

4x

No.	specification	
31452	stainless 50, 80, 100, 120 mm	10
31453	metal 50, 80, 100, 120 mm	10



FESTA

SET OF PUTTY KNIVES, PLASTIC

4x



No.	specification	
31454	50, 80, 100, 120 mm	12

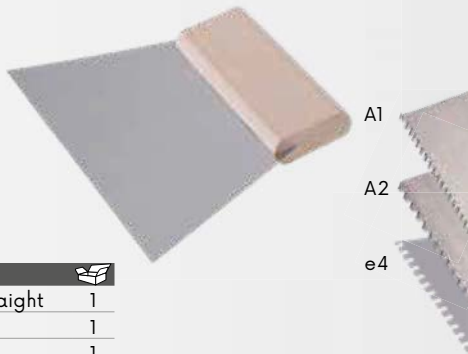

PUTTY KNIFE

No.	specification	
31601	180 mm - straight	1
31602	180mm A1	1
31603	180mm A2	1
31641	180 mm - e4	1

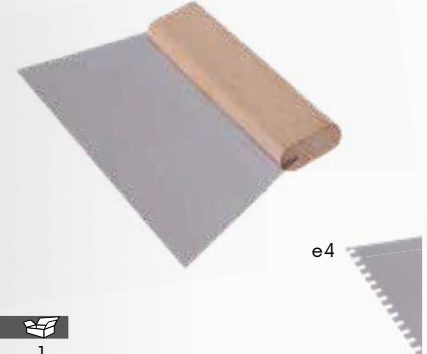

PUTTY KNIFE

No.	specification	
31651	250 mm - straight	1
31655	250 mm - e4	1

DENTED SPREADER WITH TEETH



No.	specification	
37101	125 x 85 mm	100
37111	170 x 115 mm	100



DENTED SPREADER

No.	specification	
37051	rovná	1
37031	zub - 4 x 6 mm	1
37041	zub - 6 x 6 mm	1



PLASTERERS TROWEL

No.	specification	
32022	140 x 80 mm	12
32023	125 x 40 mm	12

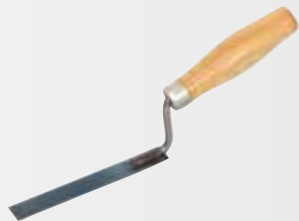

JOINT TROWEL ONE-SIDED

No.	specification	
32040	10 mm	20
32041	12 mm	20
32042	15 mm	20
32043	18 mm	20
32044	20 mm	20



JOINT TROWEL DOUBLE-SIDED

No.	specification	
32050	10 12 mm	50
32051	10 15 mm	50
32052	10 18 mm	50
32053	15 20 mm	50

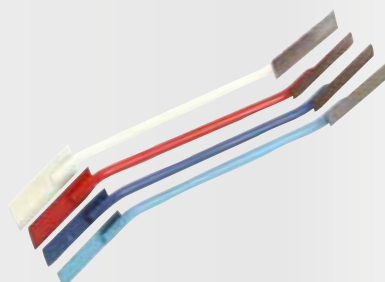

FESTA

BAR TROWEL
FOR AERATED
CONCRETE

· poplar



MOQ
2

No. specification
32317 450 x 95 mm

**FESTA**

FINE BAR TROWEL
FOR AERATED
CONCRETE

· poplar



MOQ
2

No. specification
32312 450 x 95 mm

**FESTA**

BAR TROWEL
FOR AERATED
CONCRETE

· poplar



MOQ
2

No. specification
32337 260 x 95 mm

**FESTA**

FINE BAR TROWEL
FOR AERATED
CONCRETE

· poplar



MOQ
2

No. specification
32338 260 x 95 mm

**FESTA**

BAR TROWEL
FOR BRISOLITE

· poplar



MOQ
2

No. specification
32327 230 x 145 mm



BAR TROWEL
FOR AERATED
CONCRETE



MOQ
2

No. Specification
32332 450 x 95 mm



BAR TROWEL
FOR BRISOLITE



MOQ
2

No. Specification
32333 230 x 145 mm

**FESTA**

BAR TROWEL



MOQ
2

No. specification
32314 400 x 180 mm

**FESTA**

BAR TROWEL



MOQ
2

No. specification
32329 270 x 130 mm



BAR TROWEL
WITH HOLES



MOQ
2

No. specification
33168 380 x 160 mm

**FESTA**

BAR TROWEL

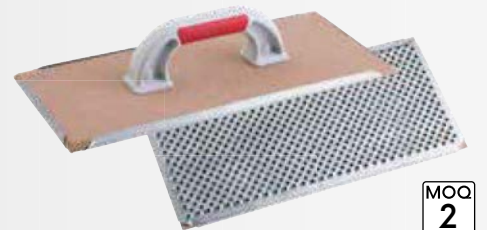

MOQ
2

No. specification
32320 400 x 180 mm



BAR TROWEL



MOQ 2

No.	Specification	
32311	400 x 180 mm	2

FESTA
SANDING TROWEL PLASTIC



MOQ 2

No.	specification	
32324	270 x 130 mm asperity 16	2
32323	270 x 130 mm asperity 16 sanding paper	10

BAR TROWEL



Zn



MOQ 2

No.	specification	
32328	285 x 145 mm	10

GRILL BAR TROWEL

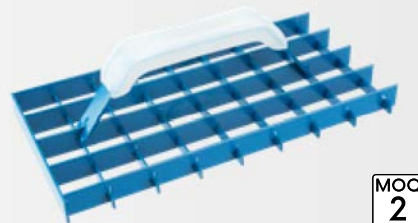

MOQ 2

No.	specification	
32316	280 x 150 mm	20

GRILL BAR TROWEL

· 8 edges



ALU

MOQ 2

No.	specification	
32326	450 x 90 mm	20

FESTA
TROWEL PLASTIC



No.	specification	
34027	400 x 180 mm	20

FESTA
SANDING TROWEL



MOQ 2

No.	specification	
32318	400 x 180 mm	2
32319	500 x 250 mm	2
32321	400 x 180 mm asperity 16 sanding paper	10
32322	500 x 250 mm asperity 16 sanding paper	10

FESTA
SANDING TROWEL



MOQ 2

No.	specification	
32330	400 x 180 mm	2
32331	270 x 130 mm	2

FESTA
BAR TROWEL



MOQ 2

No.	specification	
32325	225 x 105 mm	2

GRILL BAR TROWEL NOTCHED

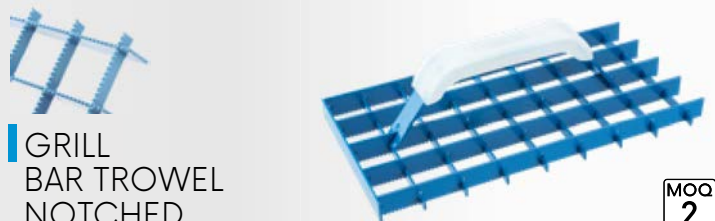

MOQ 2

No.	specification	
32335	290 x 145 mm	2

BAR TROWEL PLASTIC

· 6 edges



MOQ 2

No.	specification	
32315	270 x 90 mm	30

TROWEL PLASTIC

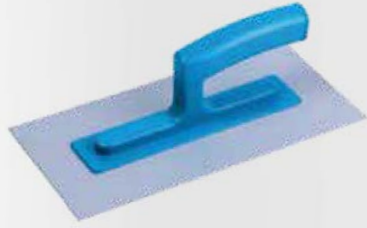

No.	Specification	
34028	400 x 180 mm	20

FESTA**TROWEL
ABS**MADE IN
EU

No.	specification	
34041	280 x 140 - 2 mm	10
34051	280 x 140 - 3 mm	10
34053	280 x 140 - 3 mm teeth - e6	10

FESTA**FLOAT
PLASTIC**

Č.p.	specifikace	
30003	270 x 125 mm	28
30004	235 x 115 mm	35
30005	210 x 115 mm	38
30007	210 x 60 mm	44

FESTA**WOODEN
TROWEL**

· linden wood



No.	specification	
34005	400 x 145 mm	40
34007	290 x 145 mm	20

**WOODEN
TROWEL**

· poplar wood

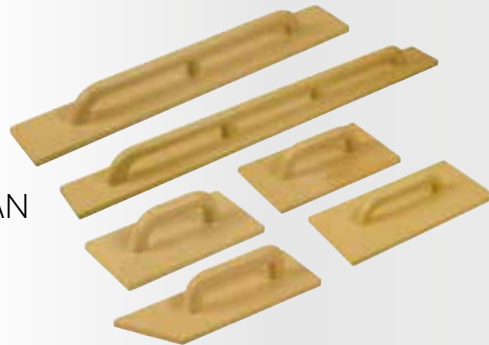

No.	specification	
34006	400 x 145 mm	40

**POLYURETHAN
FLOAT**MADE IN
EU

No.	specification		No.	specification	
34122	120 x 240 mm	50	34154	220 x 420 mm	15
34132	140 x 280 mm	40	34155	240 x 480 mm	15
34142	180 x 320 mm	25	34156	280 x 500 mm	10
34152	200 x 360 mm	20	34157	330 x 330 mm	5
34121	80 x 260 mm chamfered	50	34158	120 x 800 mm	5
34153	100 x 400 mm	30	34159	120 x 1000 mm	5
			34160	120 x 1200 mm	5

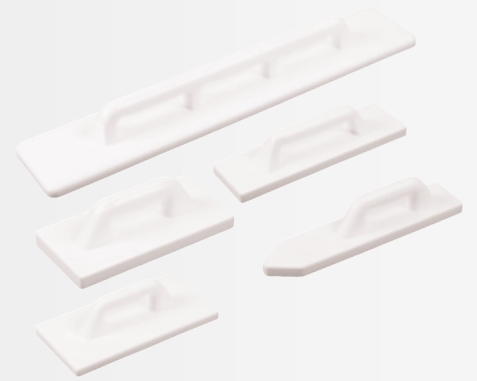
**POLYSTYREN
FLOAT**MADE IN
EU

No.	specification	
34101	80 x 350 mm chamfered	10
34061	130 x 270 mm	10
34111	170 x 320 mm	10
34071	130 x 450 mm	10
34081	140 x 750 mm	10
34091	140 x 900 mm	5

**POLYURETHAN
FLOAT**

No.	specification	
34115	140 x 280 mm	36
34116	180 x 320 mm	36
34117	200 x 360 mm	24

**MASON
STAFF**MADE IN
EU

No.	specification	
15889	980 x 380 mm butt Ø 32 mm	1

Ø 23 mm

**MASON STAFF - RUBBER**

No.	specification	
15886	450 mm butt Ø 23 mm	48
15887	600 mm butt Ø 23 mm	48
15888	750 mm butt Ø 23 mm	32

Ø 32 mm

**MASON
STAFF**MADE IN
EU

No.	specification	
15885	100 x 800 mm butt Ø 32 mm	1

MATERIAL SURFACE	CONCRETE		PLASTER			STICK AND JOINTING MATERIAL	FACADE STICK	APPLICATION
	ROUGH	SCREEDING	CORE	SOFT INWARD	SOFT YONG			
BLACK FELT (BROWN, GREY)				••••		••		grading of the soft plaster, using for the bigger corn of the plaster
WHITE FELT				••••	••••	••••		grading of the soft plaster, using for the smaller corn of the plaster
SOFT FOAM				••••	••••	••••		elimination of the free sand, for the soft stucco
ROUNG FOAM				••••	••••	••••		elimination of the free sand, for the rough stucco
RASTER FOAM				••••	••••	••••		elimination of the free sand, thanpcs to the raster gives better capture of the rough stucco
SEA SPONGE					•••		••••	washing of the jointing material, for the thin joint, elimination of the sand
HYDRO SPONGE SOFT, ROUNG					•		••••	washing of the jointing material, for the thick joint, elimination of the sand
SPONGE				••	••••	••	••••	washing of the jointing material, assurance of the soft plaster
MICRO RUBBER							••••	crowd the jointing material to the joint
RUBBER FOAM							••••	crowd the jointing material to the joint
MIRELON		••••	•••					process with the concrete, defray of the core
DUREN				••••	••	••••		match of the soft plaster
WOOD	••••	••••	••••					process with the concrete, defray of the core
STEEL PLATE	••	••••		••		••••	••	smoothing of the concrete, inaccessible places
POLYSTYRENE	•••	••••	•••	••		••		process with the concrete, defray of the core
POLYURETHAN	••••	••••	••••					process with the concrete, defray of the core
ABS		••		••••	••••	••••	••••	combed and twisted stucco, spreading of the soft plaster, scuntion
STAINLESS SMOOTH				••••	••••	••••	••••	spreading of the soft plaster, spreading of the facade stick
STAINLESS TOOTHED							••••	spreading of the stick for facings and pavings
GRINDING FLOAT FOR POLYSTYRENE, PLASTIC			••				••••	grinding of the polystyrene, grinding of the cement stick, concrete, walling, plaster
GRINDING FLOAT FOR POLYSTYRENE, POLYWOOD			••				••••	grinding of the facade polystyrene

**FESTA**

FLOAT WITH FELT



Č.p.	specifikace	
34400	280 x 140 x 8 mm	15
34415	250 x 130 x 8 mm	15
34450	220 x 130 x 8 mm	15
34445	220 x 70 x 8 mm	20

**FESTA**

FLOAT WITH FELT



Č.p.	specifikace	
34401	280 x 140 x 10 mm	15
34416	250 x 130 x 10 mm	15
34451	220 x 130 x 10 mm	15
34446	220 x 70 x 10 mm	20

**FESTA**

FLOAT WITH SOFT MOLITAN



Č.p.	specifikace	
34404	280 x 140 x 30 mm	10
34485	280 x 130 x 20 mm	10
34486	250 x 130 x 30 mm	10
34419	250 x 130 x 20 mm	10
34453	220 x 130 x 20 mm	10
34447	220 x 70 x 20 mm	10

**FESTA**

FLOAT WITH SOFT SPONGE



Č.p.	specifikace	
34405	280 x 140 x 18 mm	15
34420	250 x 130 x 18 mm	15
34454	220 x 130 x 18 mm	15
34449	220 x 70 x 18 mm	20
34480	280 x 140 x 12 mm	15
34481	250 x 130 x 12 mm	15
34482	220 x 130 x 12 mm	15

**FESTA**

FLOAT WITH EXTRA SOFT SPONGE



No.	specification	
34443	280 x 140 x 12 mm	15
34442	250 x 130 x 12 mm	15

**FESTA**

FLOAT WITH SPONGE



No.	specification	
34441	280 x 140 x 12 mm	15
34440	250 x 130 x 12 mm	15
34439	250 x 130 x 18 mm	15



FESTA

FLOAT WITH MOLITAN



No.	specifikace	
34409	280 x 140 x 30 mm	10
34425	250 x 130 x 20 mm	10



FESTA

FLOAT WITH MOLITAN



No.	specifikace	
34410	280 x 140 x 30 mm	10
34426	250 x 130 x 20 mm	10



FESTA

FLOAT WITH SPONGE



Č.p.	specifikace	
34406	280 x 140 x 30 mm	10
34421	250 x 130 x 30 mm	10
34455	220 x 130 x 30 mm	10



FESTA

FLOAT WITH SPONGE



Č.p.	specifikace	
34413	280 x 140 x 30 mm	10
34428	250 x 130 x 30 mm	10



FESTA

FLOAT WITH SPONGE



Č.p.	specifikace	
34412	280 x 140 x 30 mm	10
34424	250 x 130 x 30 mm	10
34458	220 x 130 x 30 mm	10

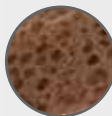

FESTA

FLOAT WITH SPONGE



Č.p.	specifikace	
34490	280 x 140 x 30 mm	10
34491	250 x 130 x 30 mm	10



FESTA

FLOAT WITH SPONGE



Č.p.	specifikace	
34411	280 x 140 x 30 mm	10
34423	250 x 130 x 30 mm	10
34457	220 x 130 x 30 mm	10



FESTA

FLOAT WITH RUBBER

Č.p.	specifikace	
34402	280 x 140 x 10 mm	15
34417	250 x 130 x 10 mm	15
34452	220 x 130 x 10 mm	15



FESTA

FLOAT WITH MICRORUBBER

Č.p.	specifikace	
34403	280 x 140 x 8 mm	15
34418	250 x 130 x 8 mm	15
34496	220 x 130 x 8 mm	15



FESTA

FLOAT WITH DUREN

Č.p.	specifikace	
34407	280 x 140 x 20 mm	10
34422	250 x 130 x 20 mm	10
34456	220 x 130 x 20 mm	10
34448	220 x 70 x 20 mm	10



FESTA

FLOAT WITH RUVEN



Č.p.	specifikace	
34414	280 x 140 x 20 mm	10
34429	250 x 130 x 20 mm	10



FESTA

FLOAT PLASTIC

Č.p.	specifikace	
30003	270 x 125 mm	28
30004	235 x 115 mm	35
30005	210 x 115 mm	38
30007	210 x 60 mm	44



FESTA

FLOAT

MADE IN
EU

Č.p.	specifikace	
34033	240 x 95 mm	5

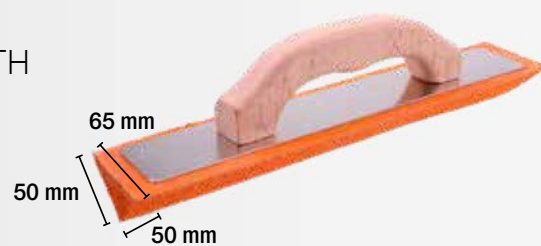
FLOAT WITH
SPONGE
90°

Č.p.	specifikace	
34500	350 mm	6

REPLACEMENT
FELTMADE IN
EU

Č.p.	specifikace	
34241	280 x 140 x 8 mm	1
34223	250 x 130 x 8 mm	1

REPLACEMENT
FELTMADE IN
EU

Č.p.	specifikace	
34243	280 x 140 x 10 mm	1
34221	250 x 130 x 10 mm	1

REPLACEMENT
SOFT SPONGEMADE IN
EU

Č.p.	specifikace	
34262	280 x 140 x 18 mm	1

REPLACEMENT
SOFT MOLITANMADE IN
EU

Č.p.	specifikace	
34251	280 x 140 x 30 mm	1

REPLACEMENT
MOLITANMADE IN
EU

No.	specification	
34261	280 x 140 x 30 mm	1

REPLACEMENT
SPONGEMADE IN
EU

No.	specification	
34265	280 x 140 x 30 mm	1

REPLACEMENT
SPONGEMADE IN
EU

No.	specification	
34238	280 x 140 x 30 mm	1

REPLACEMENT
SPONGEMADE IN
EU

No.	specification	
34237	280 x 140 x 30 mm	1
34235	250 x 130 x 30 mm	1

REPLACEMENT
RUBBERMADE IN
EU

No.	specification	
34231	280 x 140 x 10 mm	1



FESTA

ELECTRIC MIXER FOR BUILDING MIXTURES

Input	1800 W
Voltage / frequency	230 V / 50 Hz
Gears	2
1st gear (idle speed)	0 - 450 rpm
2nd gear (idle speed)	0 - 790 rpm
Overload protection	Yes
Mixing basket diameter	100 mm
Broom length	570 mm
Weight	5,6 kg



No.	specification	
35311	stirrer	1
35318	spare carbon brushes	1
35319	spare stirrers - pair (L + R)	1



FESTA

ELECTRIC MIXER 1600 W

Power input	1600 W
Voltage	230 V / 50 Hz
Number of gears	2
No-Load-speed	0 - 480 rpm
No-Load-speed	0 - 800 rpm
Protection	Yes
Thread	M 14
Mixing paddle	140 mm
Length of mixing paddle	600 mm
Weight	4,7 kg



No.	specification	
35310		1
35317	spare carbon brushes	1

FESTA

ELECTRIC MIXER 850W

Power input	850 W
Voltage	230 V / 50 Hz
Number of gears	1
No-Load-speed	0 - 500 rpm
No-Load-speed	-
Protection	Yes
Thread	M 14
Mixing paddle	120 mm
Length of mixing paddle	600 mm
Weight	3,7 kg



No.	specification	
35300		1
35316	spare carbon brushes	1

**WEST
BERG****ELECTRIC MIXER 1600W**

Power input	1600 W
Voltage	230 V / 50 Hz
Number of gears	2
No-Load-speed	180 - 400 ot./min.
No-Load-speed	300 - 700 ot./min.
Protection	Yes
Thread	M 14
Mixing paddle	140 mm
Length of mixing paddle	600 mm
Weight	5,4 kg

M14 Zn CE

No.	specification	
35305		1
35315	spare carbon brushes	1

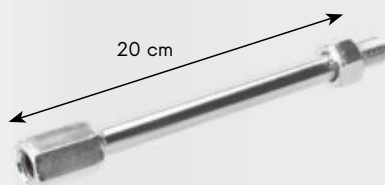
**FESTA****MIXER
EXTENSION****M14**

No.	Specifications	
35142	M14	1

**FESTA****SPIRAL MIXER CLOCKWISE**

Spiral mixer paddle with 3 blades and a ring – right handed – for heavy materials with a high viscosity, mortar, concrete, cement and calcareous plaster, jointing material, daub, epoxy mortar, bituminous binder. The mixing effect from below up –the paddle is taken into the material like a screw.

Zn	M14	No.	specification		
		35085	M14 Ø 120 x 600 mm	12	
		35086	M14 Ø 140 x 600 mm	12	
		35087	M14 Ø 160 x 600 mm	12	

**FESTA****SPIRAL MIXER COUNTERCLOCKWISE**

Spiral mixer paddle with 3 blades and a ring – left handed – for slurry fluid mixtures in bulky amounts. The mixed material is pressed down. The slurry liquid does not splash from the bin, the settled pigmentation of paints can get up and are mixed perfectly.

Zn	M14	No.	specification		
		35091	M14 Ø 120 x 600 mm	12	
		35092	M14 Ø 140 x 600 mm	12	
		35093	M14 Ø 160 x 600 mm	12	

**FESTA****SPIRAL MIXER**

Spiral mixer paddle with 2 blades – for the full mixture of the tile cement, jointing materials, sizing material, renders, screed, blinding materials, smoothing compounds.

Zn	No.	specification	
	35038	Ø 80 x 500 mm	24
	35058	Ø 100 x 500 mm	24
	35023	Ø 120 x 500 mm	24



FESTA

SPIRAL MIXER

Spiral mixer paddle with 2 blades - for the full mixture of the tile cement, jointing materials, sizing material, renders, screed, blinding materials, smoothing compounds.

SDS+	Zn	No.	specification	
		35094	Ø 80 x 500 mm	24
		35095	Ø 100 x 500 mm	24
		35096	Ø 120 x 500 mm	24



FESTA

SPIRAL MIXER

Spiral mixer paddle with 2 blades - for the full mixture of the tile cement, jointing materials, sizing material, renders, screed, blinding materials, smoothing compounds.

M14	Zn	No.	specification	
		35059	M14 Ø 90 x 550 mm	24



FESTA

SPIRAL MIXER WITH LONGER SPIRAL

Spiral mixer paddle with 2 blades - for the full mixture of the tile cement, jointing materials, sizing material, renders, screed, blinding materials, smoothing compounds.

	Zn	No.	specification	
		35013	Ø 80 x 500 mm	24
		35006	Ø 100 x 500 mm	24
		35007	Ø 120 x 500 mm	24

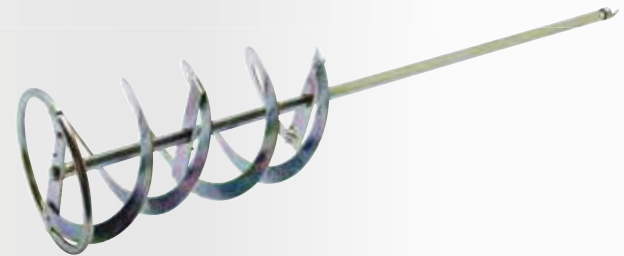

FESTA

SPIRAL MIXER WITH LONGER SPIRAL

Spiral mixer paddle with 2 blades - for the full mixture of the tile cement, jointing materials, sizing material, renders, screed, blinding materials, smoothing compounds.

SDS+	Zn	No.	specification		
		35012	Ø 100 x 500 mm	24	



FESTA

SPIRAL MIXER

Spiral mixer paddle with 2 blades - for the full mixture of the tile cement, jointing materials, sizing material, renders, screed, blinding materials, smoothing compounds.

	Zn	No.	specification	
		35069	Ø 60 x 500 mm	50
		35078	Ø 80 x 500 mm	24
		35081	Ø 100 x 500 mm	24



FESTA

SPIRAL MIXER

Spiral mixer paddle with 2 blades - for the full mixture of the tile cement, jointing materials, sizing material, renders, screed, blinding materials, smoothing compounds.

SDS+	Zn	No.	specification	
		35070	Ø 60 x 500 mm	50
		35079	Ø 80 x 500 mm	24
		35082	Ø 100 x 500 mm	24



FESTA**SPIRAL MIXER**

Spiral mixer paddle with 2 blades - for the full mixture of the tile cement, jointing materials, sizing material, renders, screed, blinding materials, smoothing compounds.

No.	specification	
35048	Ø 70 x 500 mm	24
35068	Ø 90 x 500 mm	24

**FESTA****SPIRAL MIXER**

Appropriate for high viscose and adhesive materials, such as construction adhesives and cement, plaster, screed loor cover etc. The material flows from the button to level.

No.	specification	
35021	Ø 90 x 500 mm	24

**FESTA****MIXER**

Cage mixed paddle - for materials where air intake is undesirable. For fluid smoothing compounds, blinding materials, sealing material, glue.

No.	specification	
35015	Ø 100 x 500 mm	20

**FESTA****PROPELLER MIXER**

Propeller mixer paddle - for fluid materials, paints, wall and dispersed glues for sticking wallpapers, tile glue.

No.	specification	
35011	Ø 80 x 500 mm	50

**SPIRAL MIXER**

Arcaded mixer paddle with a ring - for the full mixture of wall paints, dispersed paints, glues, flooding compounds, paints, asphalted bitumen, coatings.

No.	specification	
35125	Ø 60 x 400 mm	40
35126	Ø 80 x 400 mm	40
35127	Ø 100 x 600 mm	20

**SPIRAL MIXER LACQUARED**

Arcaded mixer paddle with a ring - for the full mixture of wall paints, dispersed paints, glues, flooding compounds, paints, asphalted bitumen, coatings.

No.	specification	
35103	Ø 60 x 400 mm	40
35113	Ø 80 x 400 mm	40
35123	Ø 100 x 600 mm	20



FESTA



PROFESSIONAL BUILDING MIXERS

Lescha

Building mixers for demanding professional use
 Gear wreath made of cast iron with patented fastening
 Double bearing seats on the drum
 Patented protection insulation, quality protection according to DIN EN ISO 9001
 Adjustable clearance teeth
 High quality finish
 Specially designed shape drum
 Protection splash-proof IP 45
 Supplied in 230V and 400V



Lescha

BUILDING MIXER



No.	specification	
35500	Star 150 - 125 l, 230 V footbrake	1



Lescha

BUILDING MIXER



No.	specification	
35502	EUROMIX 125 l, 230 V	1
35503	EUROMIX 125 l, 400 V	1



Lescha

BUILDING MIXER



No.	specification	
35501	BX 135 - 125 l, 230 V	1



Lescha

BUILDING MIXER



No.	specification	
35504	ABM 135 l, 230 V footbrake	1



Lescha

BUILDING MIXER



No.	specification	
35505	SM 145 S - 140 l, 230 V	1
35506	SM 145 S - 140 l, 400 V	1
35507	SM 145 S - 140 l, 230 V footbrake	1
35508	SM 145 S - 140 l, 400 V footbrake	1



Lescha

BUILDING MIXER



No.	specification	
35510	SM 165 S - 160 l, 230 V footbrake	1
35511	SM 165 S - 160 l, 400 V footbrake	1
35512	SM 165 S - 160 l, G petrol	1



Lescha

BUILDING MIXER



No.	specification	
35514	SM 185 S - 180 l, 230 V footbrake	1
35515	SM 185 S - 180 l, 400 V footbrake	1



Lescha

BUILDING MIXER



No.	specification	
35516	S 180 HR - 180 l, 230 V footbrake	1
35517	S 180 HR - 180 l, 400 V footbrake	1



Lescha
BUILDING MIXER



No.	specification	
35524	LB 354 230 V, 1,5 kW	1
35525	LB 354 400 V, 1,5 kW	1
35527	LB 354 Honda G200	1
35532	LB 404 230 V, 1,5 kW	1
35533	LB 404 400 V, 1,5 kW	1
35539	LB 484 Robin EH17B	1
35540	LB 484 Honda GX160LX	1
35542	AT 480 400 V, 1,2 kW	1

Lescha
BUILDING MIXER



No.	specification	
35518	S 230 HR - 230 l, 230 V footbrake	1
35519	S 230 HR - 230 l, 400 V footbrake	1

Lescha
BUILDING MIXER



No.	specification	
35552	LHB 1000 400 V	1
35553	LHB 1000 HATZ Diesel	1
35555	LHB 1200 400 V	1



BUILDING MIXER



No.	specification	
37500	MIX 130Zk 230 V unassembled	1
37501	MIX 130Z 230 V assembled	1
37505	MK 165Bk 230 V unassembled	1
37506	MK 165B 230 V assembled	1

130 L

specification	
volume of drum	130 l
drum speed	26±Min ⁻¹
power	700 W
voltage	230 V / 50 Hz
degree of protection	IP44
material of chaplet	cast iron
specification	length 1170 mm
	width 650 mm
	high/ high 1280 mm
weight	53 kg

165 L

specification	
volume of drum	165 l
drum speed	23±Min ⁻¹
power	900 W
voltage	230 V / 50 Hz
degree of protection	IP44
material of chaplet	cast iron
specification	length 1295 mm
	width 735 mm
	high/ high 1440 mm
weight	70 kg

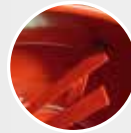

· specially made shoulder-blade 4 mm



· good quality thrust bearing



· switch with safety shield

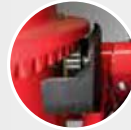

· plastic shield of drive, cast iron wreath

BUILDING MIXER



125 L

specification	
volume of drum	125 l
drum speed	26±Min ⁻¹
power	550 W
voltage	230 V / 50 Hz
degree of protection	IP44
material of chaplet	cast iron
specification	length 1102 mm
	width 690 mm
	high/ high 1310 mm
weight	52,5 kg

No.	specification		
37509	126 l, 230 V	assembled	1
37510	126 l, 230 V	unassembled	1

162 L

specification	
volume of drum	162 l
drum speed	26±Min ⁻¹
power	650 W
voltage	230 V / 50 Hz
degree of protection	IP44
material of chaplet	cast iron
specification	length 1180 mm
	width 710 mm
	high/ high 1310 mm
weight	56 kg

No.	specification		
37515	162 l, 230 V	unassembled	1
37516	162 l, 230 V	assembled	1

142 L

specification	
volume of drum	142 l
drum speed	26±Min ⁻¹
power	650 W
voltage	230 V / 50 Hz
degree of protection	IP44
material of chaplet	cast iron
specification	length 1164 mm
	width 690 mm
	high/ high 1293 mm
weight	54 kg

No.	specification		
37511	142 l, 230 V	unassembled	1
37512	142 l, 230 V	assembled	1

180 L

specification	
volume of drum	180 l
drum speed	26±Min ⁻¹
power	850 W
voltage	230 V / 50 Hz
degree of protection	IP44
material of chaplet	cast iron
specification	length 1164 mm
	width 690 mm
	high/ high 1368 mm
weight	58 kg

No.	specification		
37517	180 l, 230 V	unassembled	1
37518	180 l, 230 V	assembled	1



WHEELBARROW



No.	specification		
37530	60 l, Ø 38 cm	solid tyre	1
37532	60 l, Ø 40 cm	pneumatic tyre	1



WHEELBARROW GALVANIZED



No.	specification		
37527	80 l, Ø 40 cm	pneumatic tyre	1
37533	80 l, Ø 38 cm	solid tyre	1

WHEELBARROW
HULL BLACK



No.	specification	
37539	60 l	1

WHEELBARROW
HULL GALVANIZED



No.	specification	
37541	80 l	1

SPARE
WHEELS



No.	specification	
48729	typ AA 400 pneumatic tyre	1
48730	typ AA 380 solid tyre	1
48731	typ AA 380 solid tyre (Slovakia)	1

WHEELBARROW
WITH
THREE WHEELS



No.	specification	
37564	60 l	1



Lescha

CONSTRUCTION DEBRIS CHUTE



No.	specification	
35603	drop basic diameter 50/40 cm, length 108 cm PE (HDPE)	1
35604	PE building debris (HDPE)	1
35605	supporting frame for hopper conformity of building rubble	1

HORIZONT®



HORIZONT®

MASON STAFF

ALU

No.	specification	
15310	100 cm	10
15315	150 cm	10
15318	180 cm	10
15320	200 cm	10
15325	250 cm	10
15330	300 cm	10
15335	350 cm	10
15340	400 cm	10



HORIZONT®

MASON STAFF, 1 VIAL

ALU

No.	specification	
15415	150 cm	10
15418	180 cm	10
15420	200 cm	10
15425	250 cm	10
15430	300 cm	10



HORIZONT®

MASON STAFF, 2 VIALS

ALU

No.	specification	
15510	100 cm	10
15515	150 cm	10
15518	180 cm	10
15520	200 cm	10
15525	250 cm	10
15530	300 cm	10
15535	350 cm	10
15540	400 cm	5



HORIZONT®

MASON STAFF, 2 HANDLES, WITHOUT VIALS

ALU

No.	specification	
15615	150 cm	10
15620	200 cm	10
15625	250 cm	10
15630	300 cm	10



HORIZONT®

MASON STAFF, 2 VIALS, 2 HANDLES

ALU

No.	specification	
15710	100 cm	10
15715	150 cm	10
15720	200 cm	10
15725	250 cm	10
15730	300 cm	10
15735	350 cm	10
15740	400 cm	5





HORIZONT
MASON STAFF, TRAPEZ

PROFILE TRAPEZOIDAL
 · trapezoidal profile for finer surface finishes
 · suitable for stuccoers and facades
 · suitable for thin-film plasters

ALU	No.	specification	
	15810	100 cm	10
	15812	120 cm	10
	15815	150 cm	10
	15818	180 cm	10
	15820	200 cm	10
	15825	250 cm	10
	15830	300 cm	10



HORIZONT
MASON STAFF, "h" PROFIL

PROFILE "h"
 · "h" profile for finer surface finishes
 · suitable for stuccoers and facades
 · suitable for stucco plastering

ALU	No.	specification	
	15850	100 cm	10
	15853	150 cm	10
	15855	180 cm	10
	15860	200 cm	10
	15870	250 cm	10
	15880	300 cm	10

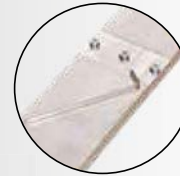
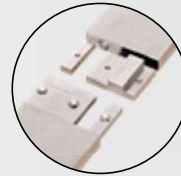

NEW

HORIZONT
CONNECTOR
FOR SCREED
LEVELS

No.	Specifications		
15301		1	



HORIZONT
MASON STAFF,
1 VIAL- ADJUSTABLE

No.	specifications		
15893	65 - 100 cm	1	
15894	95 - 150 cm	1	
15895	145 - 235 cm	1	



HORIZONT
SQUARE

ALU	No.	specification	
	14485	800 x 1200 mm	1
	14486	1000 x 1500 mm	1





FESTA

BAR BENDER

No.	Specifications	
26730	Ø 6 - 14 mm	1
26731	Ø 5 - 8 mm	1



NEW

FESTA

BRICK CLAMP

No.	Specifications	
60130	27 - 45 cm	10



NEW



FESTA

PAVER PULLER

No.	Specifications	
60132		1



NEW

FESTA

PAVING CRUB TROLLEY

· max 150 kg



No.	Specifications	
60157		1



BAR BENDER

No.	Specifications	
26735	max Ø 13 mm 56 cm	1

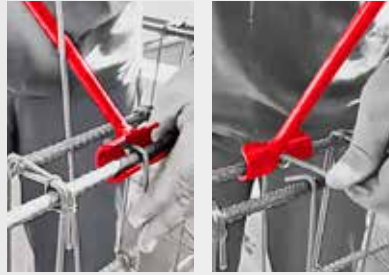

NEW

BAR BENDER

· Ø 4-8 mm

No.	Specifications	
26736		1



NEW

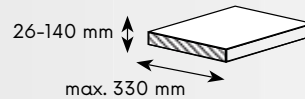

FESTA

BLOCK SPLITTER

· max 45 kg

No.	Specifications	
60125		1



NEW

FESTA

PAVING SLAB TROLLEY

· max 100 kg



No.	Specifications	
60155		1





BRICK HOLDER

No.	specification	
36310	max. 20kg	5



CURB HOLDER

specification	60115
jaw size:	80-370 mm
max. load:	50 kg

No.	specification	
60115	For 040	1



CURB HOLDER

specification	60116
jaw size:	750-1000 mm
max. load:	120 kg

No.	specification	
60116	For 041	1



CURB HOLDER

specification	60117	60118
jaw size:	500-1000 mm	0-500 mm
max. load:	150 kg	150 kg

No.	specification	
60117	For 042	1
60118	For 043	1



STRAIGHT LINE STONE HAMMER

specification	60121	60123
height	200 mm	200 mm
width	70 kg	70 kg
length	870 mm	450 mm
weight	2,5 kg	2,2 kg

No.	specification	
60121	870 mm	1
60123	450 mm	1



PAD

No.	specification	
37166	D10 basic	25



MASONRY PULLEY

No.	specification	
26780	0,5 t A with hook	1
26781	0,5 t B with eye	1
26782	0,5 t C with hook, with cover	1
26783	0,5 t D with eye, with cover	1

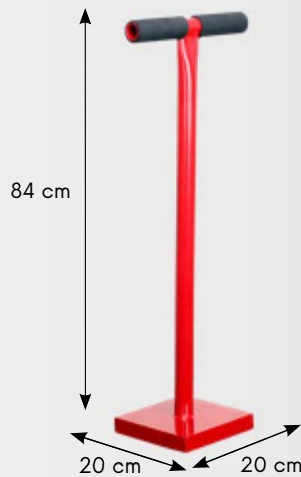

HAND RAMMER

No.	specifications	
26740	12 kg	1



HAND TRUCK

No.	specification	nosnost	
48719	wheel 260 mm bantam	250 kg	1



PROFESSIONAL TILE CUTTING MACHINES

- tile cutting machines for the most demanding usage
- the travel has 9 sleeved skf ball bearings
- 4 of them are adjustable and define the limits of the travel
- spring-loaded tables
- possible to assemble for working with left hand
- all spare parts and repair services are guaranteed
- the cutting wheel from chrome-wolfram steel

SUPER PRO



TILE CUTTING MACHINE SUPER FOR "EVO"

· 36195 spare cutting wheel - Ø 22 mm



No.	specification
36191	1250 mm

1



SUPER PRO



TILE CUTTING MACHINE

· 36195 spare cutting wheel - Ø 22 mm



No.	specification
36145	SUPER For 450 mm
36160	SUPER For 600 mm
36175	SUPER For 750 mm
36190	SUPER For 900 mm

1

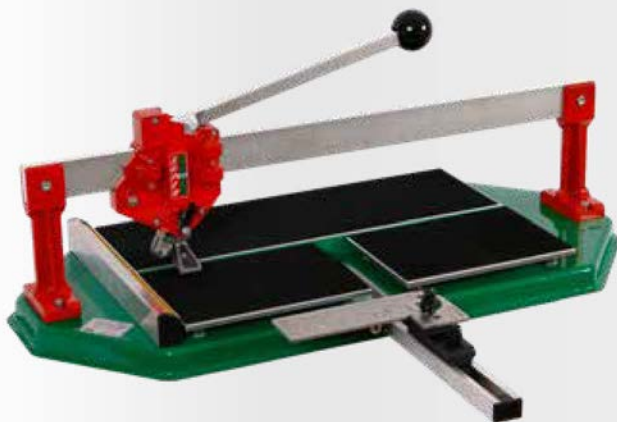

· illustrative photo

SUPER FOR STAND



No.	specification
36200	sales stand
36199	sales stand fitted 36160, 36175, 36190

1

1



FESTA

TILE CUTTING MACHINE „X“

· 36138 spare cutting wheel - Ø 22 mm



No.	specification	
36085	600 mm	1
36087	900 mm	1
36086	1300 mm	1



FESTA

TILE CUTTING MACHINE

· 36139 spare cutting wheel - Ø 22 mm



No.	Specifications	
36102	1050 mm	1
36103	1300 mm	1
36105	1550 mm	1



FESTA

TILE CUTTING MACHINE

· 36195 spare cutting wheel - Ø 22 mm



No.	specification	
36080	600 mm	1
36081	750 mm	1
36082	900 mm	1
36076	750 mm assembled	1
36077	900 mm assembled	1



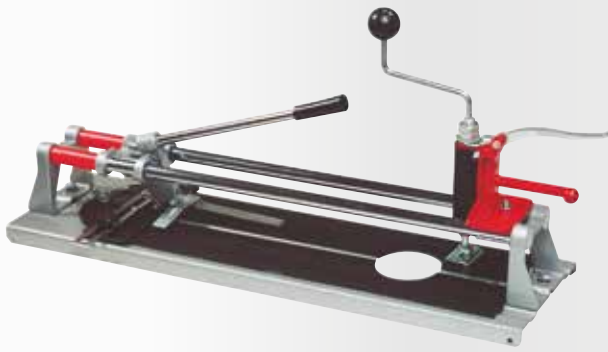

TILE CUTTING MACHINE

· 36128 spare cutting wheel - Ø 16 mm



No.	specification	
36014	480 mm	4

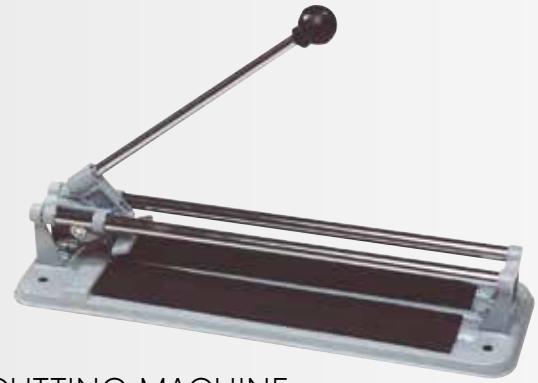

TILE CUTTING MACHINE

· 36126 spare cutting wheel - Ø 15 mm



No.	specification	
36024	300 mm	10
36034	400 mm	10
36035	600 mm	4



TILE CUTTING MACHINE

· 36136 spare cutting wheel - Ø 22 mm



No.	specification	
36036	480 mm	1



HAND TILE CUTTER

· 36136 spare cutting wheel - Ø 22,2 mm



No.	specification	
36046	22 mm	1

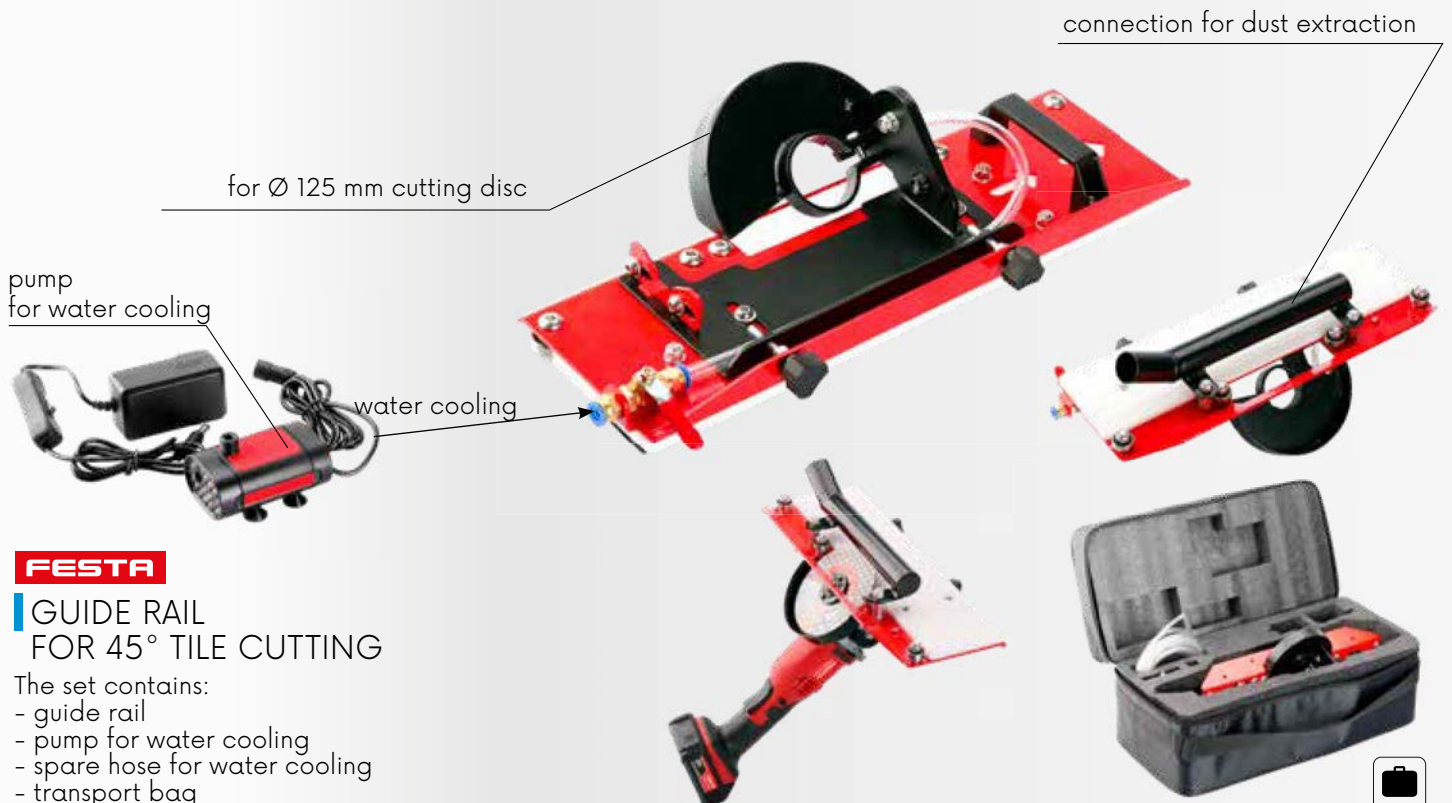

FESTA

GUIDE RAIL FOR 45° TILE CUTTING

The set contains:

- guide rail
- pump for water cooling
- spare hose for water cooling
- transport bag

No.	specifications	
24680		1

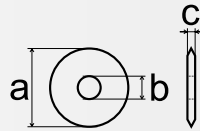

SPARE CUTTING WHEEL



Broj	specifikacija	
36126	a= Ø 15 mm, b= Ø 6 mm, c= 1,5 mm	1
36128	a= Ø 16 mm, b= Ø 6 mm, c= 3 mm	1
36130	a= Ø 20 mm, b= Ø 6 mm, c= 5 mm	1
36136	a= Ø 22 mm, b= Ø 6 mm, c= 2 mm	1
36138	a= Ø 22 mm, b= Ø 6 mm, c= 5 mm	1
36139	a= Ø 22 mm, b= Ø 6 mm, c= 6 mm	1
36195	a= Ø 22 mm, b= Ø 6 mm, c= 4,8 mm	1



JIG SAW BLADE FOR TILE CUTTING

No.	specification	
24055	Karbid - BOSCH, MAKITA	1



FESTA

TILE PLIER



No.	specification	
36057	200 mm	6



TILE CUTTING PLIERS



No.	specification	
36056		10



TILE PLIER



No.	specification	
36059		1



TILE PLIER



No.	specification	
36058	200 mm	6



FESTA

LAMINATE FLOOR CUTTER



No.	specification	
36140	210 mm	4



NEW



FESTA

SILICON SCRAPER 5in1



1

No.	Specifications
37050	

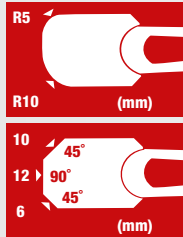

FESTA

SILICON SCRAPER



50

No.	specification
16056	145 mm

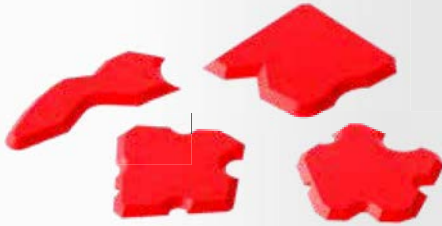

SILICON SPREADER SET

4x



1

No.	specifications
37052	



DENTED SPREADER

4x



48

No.	specification
37053	



SILICON SCRAPER

No.	specification
37054	



1



SILICON SCRAPER

· for joining of windows

No.	specification
37055	



1



SQUEEGEE

No.	specification
37011	180 mm
37021	280 mm



12

12



37028



37029

SPONGE 160 X 110 X 60 MM

No.	specification
37028	hydro sponge
37029	sponge cube



1

1



37025



37026

SPONGE 200 X 100 X 100 MM

No.	specification
37025	soft molitan cube
37026	sponge cube



1

1



WASH BUCKET

No.	specification
37117	set
90070	tub 25 l



1

1

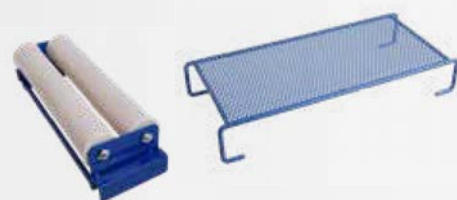

WASH BUCKET - ACCESSORIES

No.	specification
90072	grid
90071	metal rolls



1

1



TIPPED CLEANER

No.	specification	
37012		1



TIPPED CARBIDE CLEANER

No.	specification	
37006	30 mm	20
37007	50 mm	20
37008	spare blade 30 mm	50
37009	spare blade 50 mm	50



SET FOR APPLICATION AND REMOVING SILICONE

No.	specification	
16042		12



MAGNETS FOR TILES

No.	specification	
38920		1



ADJUSTABLE MAGNETS TILES

No.	specification	
38923		24



BUILDING CORNERS SET

No.	specification	
38919		50



CAULKING GUN

· capacity 1,5 l

No.	specification	
38026	5x tip	25



NEW

- Ø 10 mm
- Ø 14 mm
- Ø 20 mm
- Ø 10 x 35 mm



MORTAR GROUT GUN

No.	specification	
38045	4x nozzle	1



POINTING BAG

No.	specification	
38042	3x tip	6





FLOATING FLOOR INSTALLATION KIT

24x	No.	52130	1
	specification		



WEDGES

50x

No.	specification	pcs	
37210	95 x 45 x 15 - 0 mm	50	1
37211	70 x 30 x 8 - 0 mm	50	1



PUMP WEDGE

· dimension 15x17 cm
· height max. 5 cm

No.	37220	1
specification		

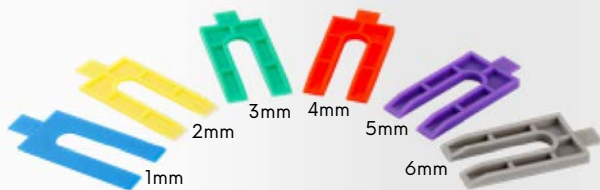

LEVELLING PADS

30x

No.	specification	1
37212	1 - 6 mm, 5 pcs per size	1

FESTA WEDGES



No.	specification	pcs	
37204	55 x 20 x 0 - 6 mm	20	1
37203	65 x 18 x 0 - 12 mm	20	1
37202	80 x 25 x 3 - 10 mm	20	1
37201	100 x 25 x 1 - 16 mm	14	1
37200	150 x 25 x 1 - 25 mm	8	1



FESTA PLASTIC WEDGES

No.	specification	pcs	
37155	0 - 8 mm	30	100
37156	0 - 4 mm	100	100
37157	2,5 - 8 mm	30	100



FESTA WEDGES

250x

No.	specification	pcs	
37205	55 x 8 x 0 - 10 mm	250	1



NIVELYS TILE LEVELING PROFILE

No.	Specifications	1
37105	50 cm	1
37106	100 cm	1
37107	150 cm	1



NIVELYS ADJUSTABLE STAND FOR LEVELING PROFILE

No.	Specifications	1
37102	max. 50 kg	1

NIVELYS

LEVELING SYSTEMS

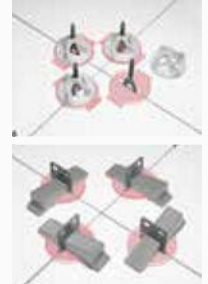

NIVELYS
LEVELING SYSTEMS FESTA

LEVELING CLIP WITH THREAD

50x

No.	specification	pcs
37131	1 mm	40
37132	2 mm	40

NIVELYS
LEVELING SYSTEMS FESTA

LEVELING CAP WITH THREAD

50x

No.	specification	pcs
37130	reusable	15

NIVELYS
LEVELING SYSTEMS FESTA

PROTECTION PLATES FOR TILE LEVELING SYSTEMS

100x

No.	specifications	pcs
37192		1

NIVELYS
LEVELING SYSTEMS FESTA

SPACERS

leveling wedges 37715, 37716

50x

No.	specification	pcs
37170	1 mm	50
37171	2 mm	50
37172	3 mm	50

NIVELYS
LEVELING SYSTEMS FESTA

SPACERS

100x

No.	specification	pcs
37185	1 mm	100
37190	1,5 mm	100
37186	2 mm	100
37187	3 mm	100
37188	4 mm	100
37189	5 mm	100

NIVELYS
LEVELING SYSTEMS FESTA

SPACERS

100x

No.	Specification	pcs
37162	1,5 mm	1

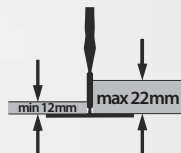

NIVELYS
LEVELING SYSTEMS FESTA

LEVELING WEDGES

No.	specification	pcs
37175		50
37176		400



NIVELYS
LEVELING SYSTEMS FESTA

NIVELYS
LEVELING SYSTEMS **FESTA**

SPACERS

600x

No.	specification	pcs	krabice	
37125	1 mm	600	38 x 28 x 19 cm	1
37126	1,5 mm	600	38 x 28 x 19 cm	1
37127	2 mm	600	38 x 28 x 19 cm	1



NIVELYS
LEVELING SYSTEMS **FESTA**

LEVELING SET

No.	specification	
37173	1 mm, 400 pcs + 200 pcs	1
37174	1,5 mm, 400 pcs + 200 pcs	1



NIVELYS
LEVELING SYSTEMS **FESTA**

LEVELING GUNS

No.
37177



1



NIVELYS
LEVELING SYSTEMS **FESTA**

LEVELING GUNS

No.
37178



1



LEVELING CLIP SET

50x

No.	specification	
37199	1,5 mm	40



NIVELYS
LEVELING SYSTEMS **FESTA**

PLASTIC CROSSES

· reusable

100x

No.	specification	pcs	
37195	1,0 mm	100	12
37196	1,5 mm	100	12
37197	2 mm	100	12
37198	3 mm	100	12



FESTA

PLASTIC CROSSES

No.	specification	pcs	
37148	1,0 mm	200	100
37149	1,5 mm	200	100
37150	2 mm	200	100
37151	2,5 mm	200	100
37152	3 mm	150	100
37153	4 mm	100	100
37154	5 mm	75	100
37158	10 mm	30	100



FESTA

TILE SPACERS

100x

No.	specifications	
37285	1,5 mm	100
37286	2 mm	100
37287	2,5 mm	100
37288	3 mm	100
37289	4 mm	100



NEW

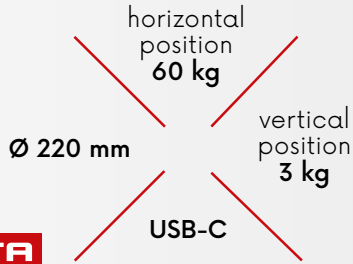

FESTA
POWER X TOOLS

SUCTION CUP

				USB-C	Li-ion 3.6V
--	--	--	--	--------------	------------------------

No.	Specifications
36326	

USB - C



1

FESTA

SUCTION TILE HOLDER WITH PRESSURE INDICATOR

--	--	--	--

No.	Specification
36325	



1



FESTA

HOLDER FOR GLASS PLATE

position	max. load
horizontal position	120 kg
vertical position	150 kg

ALU	
No.	specification
36318	triple
	10



HOLDER FOR GLASS PLATE

No.	specification	
36305	single	60

FESTA

HOLDER FOR GLASS PLATE

position	max. load
horizontal position	80 kg
vertical position	100 kg

ALU	
No.	specification
36313	double
	20



HOLDER FOR GLASS PLATE

No.	specification	
36306	double	20

FESTA

HOLDER FOR GLASS PLATE

position	max. load
horizontal position	50 kg
vertical position	50 kg

ALU	
No.	specification
36314	single
	20



HOLDER FOR GLASS PLATE

position	max. load
horizontal position	80 kg
vertical position	100 kg

No.	specification	
36319	triple	10



**FESTA**

CHALK LINER 30 M + POWDER 120 G

- 6x quicker winding mechanism
- plummet line function



No.	quantity
37070	6

**FESTA**

CHALK LINER 30 M + POWDER 150 G

- 5x quicker winding mechanism



No.	quantity
37065	6



CHALK LINER ABS 30 M + POWDER 180 G



No.	quantity
37069	10



CHALK LINER PLASTIC 30 M



No.	quantity
37066	25



CHALK LINER 30 M

ALU

No.	quantity
37068	25



CHALK LINER ABS 30 M



No.	quantity
37067	25

**FESTA**

POWDER 180 G

No.	specification	quantity
37096	blue	10
37094	light blue	10
37097	red	10
37095	light red	10
37098	black	10

**FESTA**

STRING RED



No.	specification	quantity
38895	50 m	24
38896	100 m	24

**FESTA**

STRING YELLOW



No.	specification	quantity
38899	50 m	24
38900	100 m	24

**FESTA**

STRING POLYETHYLENE 50 M



No.	specification	quantity
38907	red 1,0 mm	100
38908	red 1,7 mm	100
38909	red 2,0 mm	100



FESTA

STRING
POLYETHYLENE 50 M

No.	specification	
38904	yellow 1,0 mm	100
38905	yellow 1,7 mm	100
38906	yellow 2,0 mm	100



FESTA

STRING
POLYETHYLENE 50 M

No.	specification	
38910	orange 1,0 mm	100
38911	orange 1,7 mm	100
38912	orange 2,0 mm	100



FESTA

STRING
POLYETHYLENE 50 M

No.	specification	
38901	white 1,0 mm	100
38902	white 1,7 mm	100
38903	white 2,0 mm	100



WAXED TWINE



No.	length	Ø	
50920	50 m	1 mm	80



FESTA

PLUMB LINE WITH STRING
15 M

No.	specification	
38916	150 g	10
38917	300 g	6
38918	500 g	5

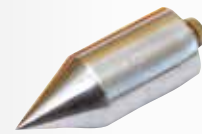

FESTA

PLUMB LINE

No.	specification	
38913	150 g	10
38914	300 g	10
38915	500 g	10

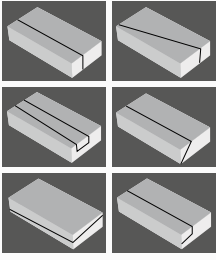

**FESTA****POLYSTYRENE CUTTER**

- voltage | frequency: 230 V/50 Hz
 - power consumption: 200 W
 - length of cut: 137 cm
 - height of cut: 30 cm
 - protection: IP44
 - angle of cut: 0° - 90°
- equipment: stand, foot switch, scaffold holder, 2x Ni-Cr cutting wire, cleaning brass brush, tools and fasteners, plastic box with wheels



No. Specification

35348

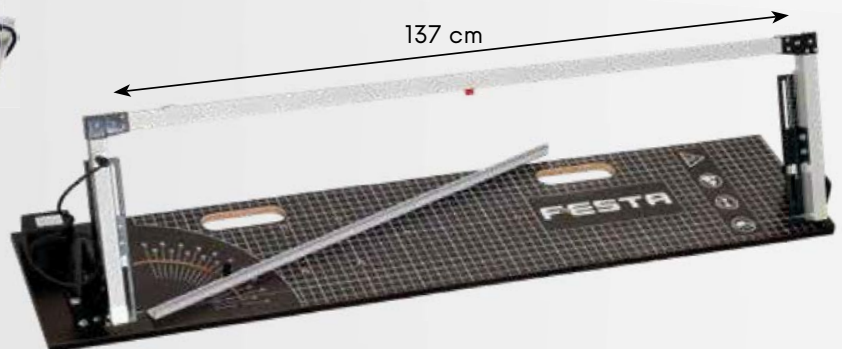
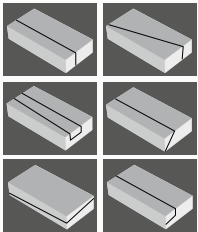

1

**FESTA****POLYSTYRENE CUTTER**

- voltage | frequency: 230 V / 50 Hz
- power consumption: 200 W
- length of cut: 137 cm
- height of cut: 30 cm
- protection: IP44
- angle of cut: 0° - 90°



· equipment: Ni-Cr cutting wire, cleaning brass brush, inbus

No. specification

35345



1

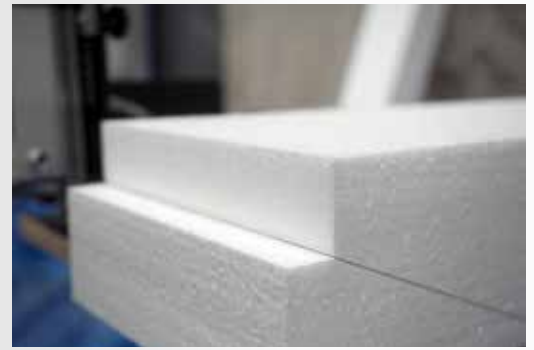

max. 52 cm



137 cm

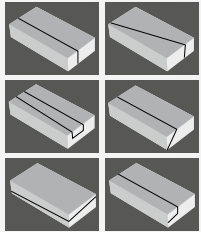

FESTA

POLYSTYRENE CUTTER

- voltage | frequency: 230 V / 50 Hz
- power consumption: 160 W
- length of cut: 117 cm
- height of cut: 52 cm
- protection: IP44
- angle of cut: 0° - 90°



• equipment: Ni-Cr cutting wire, cleaning brass brush, inbus

No. specification
35344



1

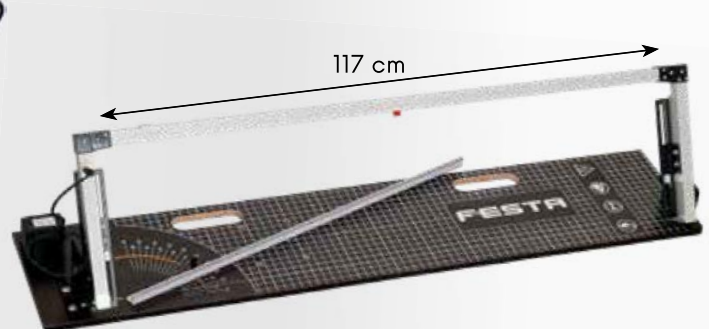
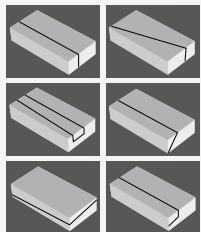

117 cm

FESTA

POLYSTYRENE CUTTER

- voltage | frequency: 230 V / 50 Hz
- power consumption: 160 W
- length of cut: 117 cm
- height of cut: 30 cm
- protection: IP44
- angle of cut: 0° - 90°



• equipment: Ni-Cr cutting wire, cleaning brass brush, inbus

No. specification
35330



1

**FESTA**

FOOT SWITCH FOR POLYSTYRENE CUTTER

for 35330, 35345, 35348



No.	Specification
35334	

1

**FESTA**

REPLACEMENT SPRING FOR A POLYSTYRENE CUTTER

for 35330, 35345, 35348



No.	Specification
35332	

1

**FESTA**

SPARE POWER ADAPTER FOR A POLYSTYRENE CUTTER

for 35330, 35345, 35348



voltage/frequency:	230 V / 50Hz
output:	36 V / 5 A
power:	200 W



Č.p.	Specification
35347	

1

**FESTA**

STAND FOR POLYSTYRENE CUTTER

for 35330, 35345, 35348



No.	Specification
35336	

1

**FESTA**

SCAFFOLD HOLDER FOR POLYSTYRENE CUTTER

for 35330, 35345, 35348



No.	Specification
35333	

1



SPARE HEATING STRING CR-NI FOR POLYSTYRENE CUTTER



No.	specification
35331	for cutter 117 cm
35346	for cutter 137 cm

1





FESTA

CORDLESS POLYSTYRENE CUTTER

- battery 36 V, 1,5Ah Li-ion
- power 180 W
- temperature max 350 C°
- length of knife 20 cm
- equipment: 2 pcs battery, charger, blade, cleaning brass brush, inbus



No.	specification	
35323	electric polystyrene cutter	1
35328	Spare knife for polystyrene cutter 14 cm	1
35329	Spare knife for polystyrene cutter 25 cm	1



FESTA

ELECTRIC POLYSTYRENE CUTTER

- voltage / frequency 230 V/50 Hz
- power consumption 250 W
- temperature 50-600 C°
- length of knife 25 cm
- length of supply cable 3 m



• equipment: cleaning brass brush, inbus, blades 25 and 30 cm, case

No.	specification	
35326	electric polystyrene cutter	1
35328	Spare knife for polystyrene cutter 14 cm	1
35329	Spare knife for polystyrene cutter 25 cm	1



GUIDE BAR FOR POLYSTYRENE CUTTER

• for 35323, 35326

No.	specification	
35327	Guide bar	1
35335	Spare knife - 30 cm	1



FESTA

POLYSTYRENE ELECTRIC CUTTER



- temperature regulation

No.	specification	
35325	220 W	1



FESTA**MILLING MACHINE FOR POLYSTYRENE****ALU**

No.	specification	
24752	Ø 65 mm	1
24753	Ø 70 mm	1

**MILLING MACHINE FOR POLYSTYRENE**

No.	specification	
24727	Ø 65 mm	1
24729	Ø 68 mm	1
24728	Ø 70 mm	1

**FASTENER****100x****MADE IN EU**

No.	specification		No.	specification	
39210	Ø 10 x 100 mm	1	39218	Ø 10 x 180 mm	1
39212	Ø 10 x 120 mm	1	39217	Ø 10 x 200 mm	1
39214	Ø 10 x 140 mm	1	39219	Ø 10 x 220 mm	1
39216	Ø 10 x 160 mm	1			

**FESTA****DOWEL INTO THE INSULATION FOR LEAD SCREW SLEEVES****2x**

No.	specification	
39240	white M10	1
39241	grey M10	1
39242	anthracite M10	1
39243	brown M10	1
39244	black M10	1

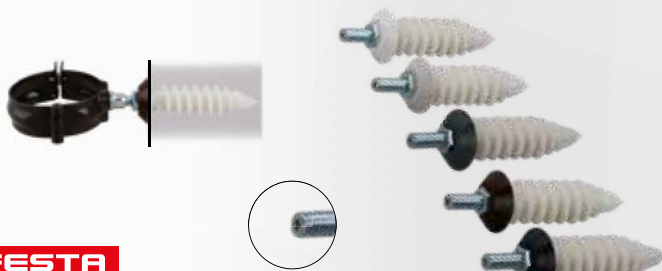
**INSULATION WASHER**

for screws Ø 6 and 8 mm

50x

No.	Specification	
39208	Ø 68 mm	1

**LEVELING ROLL****MADE IN EU**

No.	diameter	spikes high	length	
38950	Ø 69 mm	12 mm	25 cm	10
38951	Ø 69 mm	12 mm	40 cm	8
38952	Ø 122 mm	34 mm	25 mm	10
38953	Ø 122 mm	34 mm	40 cm	8
38954	Ø 122 mm	34 mm	60 mm	4

**INSULATION WASHER**

No.	specification	
39206	Ø 40 mm	200
39207	Ø 60 mm	100

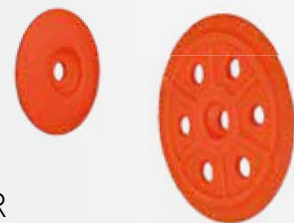
**OUTSOLE WITH SPIKES PAIR****MADE IN EU**

No.	specification	
38970	spikes 25 mm	1
38971	spikes 30 mm	1





WASHER RABICO



No.	specification	
42420	Ø 30 mm	1



FENCING RABIC



No.	specification	
42312	1 m 50 bm 16 x 16 mm	1

WOODEN PLASTER



No.	length	thickness	width	
37120	200 mm	1,7 mm	20 mm	10
37119	250 mm	1,7 mm	20 mm	10



SIEVE FOR STUCCO



No.	width	high	eye mesh	
37216	50 mm	50 mm	2 mm	1
37217	50 mm	50 mm	3 mm	1
37218	50 mm	50 mm	4 mm	1



FIBER RAINFORCING FOR CONCRETE

- +/- 150 g/ 50 kg cement
- 600 - 900 g/m² concrete or mortar



No.	vaha	
42115	0,9 kg	9

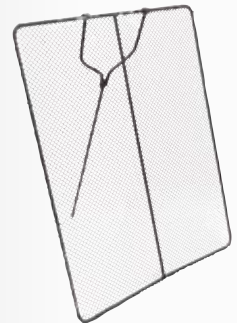

WIRE SHEET

No.	width	high	eye mesh	
37236	0,8 m	1 m	10 mm	1
37237	0,8 m	1 m	12 mm	1
37238	0,8 m	1 m	16 mm	1
37239	0,8 m	1 m	20 mm	1



P.E. SCAFFOLDING NET GREEN

No.	specification	
42120	2,5 x 20 m, 80 g/ m ² green	5



PLASTERING SPLASH MACHINE



No.	
37114	1



PLASTERING SPLASH MACHINE



No.	specification	
37115		1



DROP HOOK ZINC COATED

No.	specification	MOQ
37231	14 cm single	10



DROP FORGED HOOK

No.	specification	MOQ
37232	14,5 cm	5



HOOK SET

No.	specification	MOQ
37230	16 cm	6

CRAMP ZINC COATED

No.	specification	MOQ
37233	320 x 10 mm	100
37234	320 x 12 mm	100



CRAMP

No.	specification	MOQ
37235	250 x 12 mm	1



ALU CORNER

No.	specification	MOQ
39245	AL 30 m x 5 cm	1

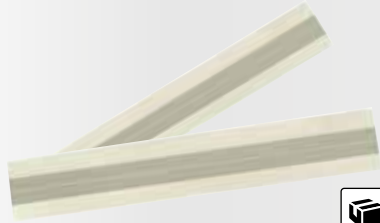

PLASTIC CORNER

MADE IN EU

No.	specification	MOQ
39238	3 m	25



DRYWALL PLASTIC PUTTY KNIFE

No.	specification	MOQ
34308	50 mm	20
34307	80 mm	12
34306	100 mm	10
34305	150 mm	12



DRYWALL PANEL LIFTER

- lift 153 - 344 cm
- max. load 54 kg

No.	specification	MOQ
26775		1



DRYWALL SET

No.	specification	MOQ
34300	set 9 pcs	10
34303	cup	60



FESTA HOLDER OF BOARDS

No.	specification	MOQ
36312		12



FESTA HOLDER OF BOARDS

No.	specification	MOQ
36308	36 x 16,5 x 7,5 cm	10





DRYWALL RASP

No.	specification	
22120	250 x 40 mm	10



DRYWALL RASP

No.	specification	
22121	250 x 40 mm	10
22122	140 x 40 mm	6



DRYWALL RASP

No.	specification	
22126	155 x 40 mm	1



DRYWALL RASP

No.	specification	
22125	Ø 250 x 40 mm	6



DRYWALL RASP

No.	specification	
22124	Ø 250 x 16 mm	10



DRYWALL RASP

No.	specification	
22123	60 x 40 mm	6

FESTA

SAW FOR DRYWALL

No.	specification	
24159	150 mm	12



PLANE FOR DRYWALL

No.	specification	
34315		10
34316	spare blade	1



DRILLING SAW FOR DRYWALL

No.	specification	
24190	300 mm	10

DRILLING SAW FOR DRYWALL RASP

No.	specification	
22130	250 x 40 mm	20
22129	155 x 40 mm	20
22132	140 x 40 mm	20
22133	60 x 40 mm	20
22134	Ø 16 x 250 mm	20



FESTA**HEATING TORCH - SET**

· Ø 17, 22, 40 mm



No.	specification
69918	2 kW, 3 m hose

**FESTA****HEATING TORCH - SET**

· Ø 25, 35, 50 mm



No.	specification
69919	19,5 kW, 1,5 m hose

**FESTA****HEATING TORCH**

No.	specification
69900	Ø 35 mm, length 300 mm, without hose
69901	Ø 35 mm, length 300 mm + 3 m hose

**FESTA****HEATING TORCH 3KW**

No.	specification
69914	300 mm + 2 m hose

**FESTA****HEATING TORCH**

No.	specification
69902	Ø 55 mm, length 550 mm, without hose

**FESTA****HEATING TORCH**

No.	specification
69903	Ø 55 mm, length 550 mm + 3 m hose

**FESTA****HEATING TORCH**

No.	specification
69905	Ø 55 mm, length 900 mm, without hose

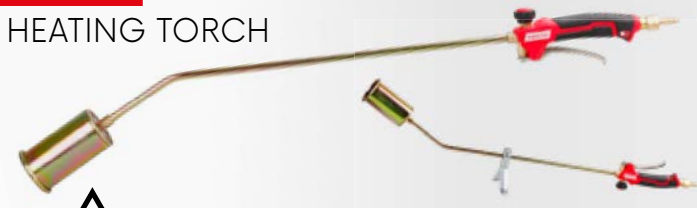
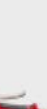
**FESTA****HEATING TORCH**

No.	specification
69906	Ø 55 mm, length 900 mm + 3 m hose



FESTA

HEATING TORCH - SET



· Ø 55 mm



No.	specification	
69904	60 kW, 850 mm, 5 m hose	8

FESTA

HEATING TORCH - SET WITH REDUCTION VALVE

· reduction valve for connection 10 and 33 kg



No.	specification	
69917	Ø 60 mm, length 900 mm + 3 m hose 3 m	1

FESTA

HOSE FOR HEATING TORCH

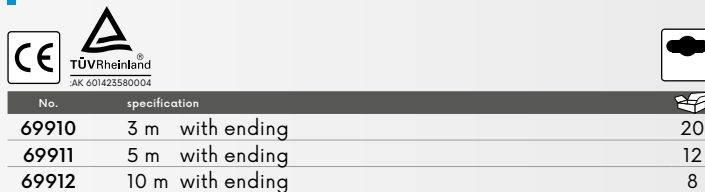

No.	specification	
69910	3 m with ending	20
69911	5 m with ending	12
69912	10 m with ending	8



PRESSURE REGULATOR PROPAN - BUTAN

inlet pressure	25 bar
outlet pressure	0,5 - 4,0 bar
nominal flow rate	16 kg h
inlet connection	W 21,8 x 1 14" LH
outlet connection	G3 8" LH

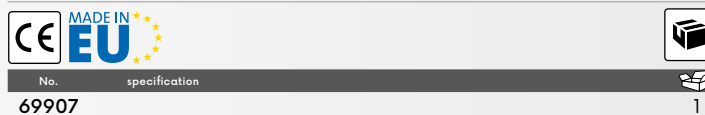

No.	specification	
69907		1

PROPANE BUTANE REDUCTION VALVE

outlet pressure	4,0 bar
nominal flow rate	16 kg h
inlet connection	W 21,8 x 1 14" LH
outlet connection	G3 8" LH

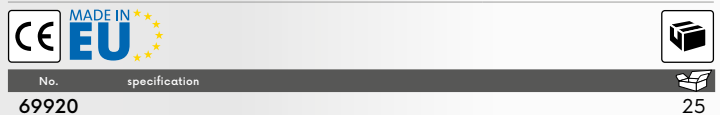

No.	specification	
69920		25

PROPANE BUTANE REDUCTION VALVE

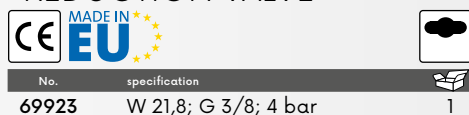

No.	specification	
69923	W 21,8; G 3/8; 4 bar	1

PRESSURE REGULATOR



No.	specification	
69908	30 mBar, prickle	1
69909	30 mBar, thread G 1/4L	1

ONE WAY PRESSURE VALVE

· out G 3/8L, for 2 kg PB bottle

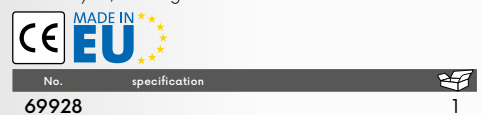

No.	specification	
69928		1

**FESTA****THREADED CARTRIDGE HEATING TORCH**

- max. temp. 1200 °C
- power 1,7 kW
- burner diam. Ø 20 mm



PIEZO START



20

**FESTA****PIERCEABLE CARTRIDGE HEATING TORCH**

- max. temp. 1200 °C
- power 1,7 kW
- burner diam. Ø 20 mm



12

**PLASTER BOWL**

No.	specification	
37121	conic	1

**PLASTER BOWL**

No.	specification	
37122	low	1

**PLASTER BOWL**

No.	specification	
33275	low, rubber	20

**BUCKET ZN COATED****Zn**

No.	specification	
39000	5 l	40
39001	10 l	30
39002	12 l	20
39003	15 l	20

**BUCKET**

No.	specification	
39005	5 l	1
39010	10 l	1
39012	12 l	1
39014	15 l with funnel	1
39020	20 l	1
39021	20 l with funnel	1

**BUCKET**

No.	specification	
39192	30 l	20
39193	45 l	20

ROUND TUB

No.	specification	
39045	45 l Ø 54 x 27 cm	1
39065	60 l Ø 60 x 35 cm	1
39090	90 l Ø 66 x 35 cm	1

RECTANGULAR TUB

No.	specification	
39145	40 l 71 x 40 x 21 cm	1
39165	65 l 71 x 40 x 30 cm	1
39190	85 l 77 x 48 x 30 cm	1

FESTA

• impact - resistant handle
nylon + fi berglass

• 360° rotatable head

• 3 position reverse step
switch

• adjustable thrust ratio
9:1 / 18:1

FESTA

CAULKING GUN
WITH REVERSE STEP SWITCH
AND ADJUSTABLE THRUST RATIO

No. specification
38027

1



NEW



FESTA

CAULKING GUN
WITH
REVERSE
STEP SWITCH

No. Specifications
38032 nylon



1



FESTA

CAULKING GUN
WITH
REVERSE
STEP SWITCH

No. specification
38028

1



FESTA

CAULKING GUN
HEAVY DUTY

No. specification
38013

12



FESTA

CAULKING GUN

No. specification
38001

24



FESTA

CAULKING GUN

No. specification
38012

6



FESTA

CAULKING GUN

No. specification
38024

1



CAULKING GUN
WITH
BACPCSTEP



No.	specification	
38010	6 square	24

CAULKING GUN



No.	specification	
38025		24

FESTA

CAULKING GUN
FOR CHEMIC
ANCHOR
380 ML



No.	specification	
38020		12

CAULKING GUN



No.	specification	
38006		12

CAULKING
GUN



No.	specification	
38002	6 square	24

CAULKING
GUN
PLASTIC



No.	specification	
38003	6 square	24

CAULKING
GUN



No.	specification	
38007		24

CAULKING
GUN
SEMI CLOSED



No.	specification	
38008		24

CAULKING
GUN
WITH TEETH



No.	specification	
38009		24

CAULKING
GUN



No.	specification	
38000		24

FESTA

CAULKING GUN



ALU

No.	specification	
38005	310 ml	20
38014	tip 3 pcs	100

FESTA

CAULKING GUN



ALU

No.	specification	
38004	600 ml	12
38014	tip 3 pcs	100

FESTA

FOAM GUN WITH TEFLON COATING



TEFLON

No.	specification	
38018		20

FESTA

FOAM GUN WITH TEFLON COATING



TEFLON

No.	specification	
38017		20

FESTA

FOAM GUN



TEFLON

No.	specification	
38016		20

FESTA

FOAM GUN



TEFLON

No.	specification	
38015		20

FOAM GUN



No.	specification	
38031		20

FESTA

FOAM GUN ABS



No.	specification	
38022	ABS	20

FOAM GUN



No.	specification	
38021		24

SPARE NOZZLE GUN TEFLON

· for PU guns 38015, 38016, 38017, 38018



TEFLON

No.	specification	
38030		5



PAINT BRUSH NATURAL

No.	width	thickness	length	
52212	20 mm	15 mm	40 mm	12
52213	30 mm	15 mm	45 mm	12
52214	40 mm	15 mm	45 mm	12
52215	50 mm	15 mm	50 mm	12
52216	60 mm	15 mm	60 mm	12
52217	70 mm	15 mm	65 mm	12
52218	80 mm	15 mm	65 mm	12
52220	100 mm	15 mm	70 mm	12



PAINT BRUSH

No.	width	thickness	length	
52202	20 mm	12,5 mm	38 mm	12
52203	30 mm	13 mm	38 mm	12
52204	40 mm	14 mm	44 mm	12
52205	50 mm	16 mm	44 mm	12
52206	60 mm	17 mm	52 mm	12
52208	80 mm	17 mm	52 mm	12
52207	100 mm	18 mm	52 mm	12



RADIATOR PAINT BRUSH

No.	width	thickness	length	
52283	25 mm	10 mm	44 mm	12
52284	38 mm	10 mm	44 mm	12
52285	50 mm	10 mm	44 mm	12
52286	62 mm	10 mm	50 mm	12
52288	76 mm	10 mm	50 mm	12

PAINT BRUSH SET
PLASTIC HANDLE

3x

No.	specification	
52070	20, 30, 50 mm	50

PAINT BRUSH
PROFESSIONALMADE IN
EU

No.	specification	
52075	Ø 90 mm	10

PAINT BRUSH
PROFESSIONALMADE IN
EU

No.	width	length	
52076	170 mm	80 mm	10

PAINT BRUSH SET
PLASTIC HANDLE

5x

No.	specification	
52071	15 mm, 25 mm, 40 mm, 60 mm, 80 mm	50



PAINT BRUSH

No.	width	length	
52077	Ø 105 mm	70 mm	12







PAINT BRUSH

No.	width	length	
52078	170 mm	70 mm	12



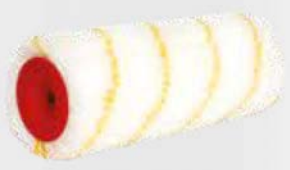

APPLICATION OF THE ROLLERS		PAINTS OR VARNISHES (LACQUERS)												
MATERIAL	THICKNESS OF PILE mm	DISPERSION	ANTICORRO-SIVE	RESIN	OIL	WATER DIL.	POLYESTER	BINDER	GLAZING	LATEX	EPOXY	2-COMPO-NENT	THICK	ACRYLIC
PES	20	•						•		•			•	
PES	20	•	•			•		•		•				•
PAC	18	•						•		•				
PAC	12, 13	•								•				
PAD	18, 21	•								•				
PAD	13	•	•							•				
LAMBSKIN	23	•								•				
NYLON	13		•	•	•	•	•			•	•	•		
VELOUR	4		•	•			•				•	•	•	
MICROFIBRE	10					•			•	•				
MOLITAN				•		•								•

PAINTROLLER POLYACRYL

PAC					
MADE IN EU					
No.					
52331	100 mm	Ø 6 mm	Ø 17 mm	12 mm	50
52334	250 mm	Ø 8 mm	Ø 48 mm	12 mm	10







PAINTROLLER POLYACRYL

PAC					
MADE IN EU					
No.					
52391	polster 5 250 mm	Ø 8 mm	Ø 54 mm	18 mm	10







PAINTROLLER POLYACRYL

PAC					
MADE IN EU					
No.					
52328	polster 5 250 mm	Ø 8 mm	Ø 54 mm	18 mm	10
52456	polster 7 250 mm	Ø 8 mm	Ø 67 mm	18 mm	10







PAINTROLLER POLYAMIDE

PAD					
MADE IN EU					
No.					







ROLLER FOR GLAZING - NYLON

PAD					
MADE IN EU					
No.					
52421	100 mm	Ø 6 mm	Ø 17 mm	13 mm	50
52424	250 mm	Ø 8 mm	Ø 48 mm	13 mm	10

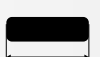





PAINTROLLER, POLYESTER

PES					
MADE IN EU					
No.					
52305	180 mm	Ø 6 mm	Ø 42 mm	20 mm	10
52306	250 mm	Ø 6 mm	Ø 42 mm	20 mm	10



VARNISHING ROLLER, FOAM

MADE IN EU					
No.					
52471	straight	100 mm	Ø 6 mm	Ø 35 mm	50



PAINTING SET

PAC

MADE IN EU

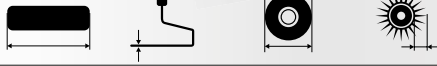

No.	specification	quantity
52600	polster 4 180 mm Ø 8 mm Ø 53 mm 18 mm	1

PAINTING SET

PES

MADE IN EU

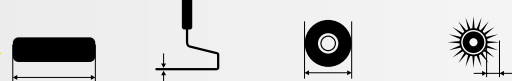

No.	specification	quantity
52610	180 mm Ø 6 mm Ø 42 mm 20 mm	25
52605	250 mm Ø 6 mm Ø 42 mm 20 mm	20

PAINTING SET

- 1x paintroller PAD 13mm/10 cm
- 1x paintroller PAC 12mm/10 cm
- 1x paintroller PES 11mm/10 cm
- handle
- bowl

MADE IN EU



No.	quantity
52602	10

CORNER
PAINTROLLER
POLYACRYL

PAC

MADE IN EU

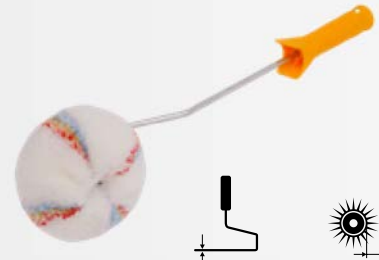

No.	specification	quantity
52601	with handle Ø 6 mm 18 mm	1

PAINT TRAY

MADE IN EU



No.	specification	quantity
52662	150 x 270 mm 100 mm	1
52666	260 x 290 mm 180 mm	1
52671	330 x 340 mm 250 mm	1

PAINT BUCKET

MADE IN EU



No.	specification	quantity
52694	8 l	25
52695	12 l	20

WIPE GRID

MADE IN EU



No.	width	high	quantity
52652	230 mm	250 mm	100
52656	270 mm	290 mm	100



HANDLE

MADE IN EU



HANDLE



No.	specification	quantity
52640	5 cm Ø 6 mm	100
52645	8,5 cm Ø 6 mm x 27 mm	100

MADE IN EU

No.	specification	quantity
52630	18 cm Ø 6 mm	100
52635	25 cm Ø 6 mm	100
52620	18 cm Ø 8 mm	50
52625	25 cm Ø 8 mm	50

SCRAPER FOR PAINT
AND LACQUER

No.	quantity
37005	12



FESTA

TELESCOPIC POLE

thread for 31610, 34203

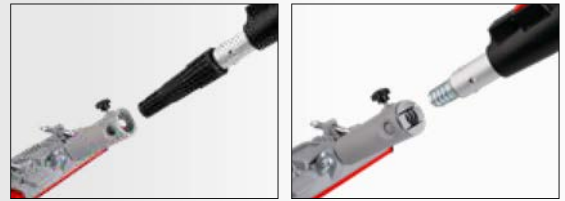

No.	Specification	
52011	88 - 140 cm	1



TELESCOPIC POLE

ALU

No.	length		
52010	120 cm	ALU	50
52012	240 cm	ALU	25



TELESCOPIC POLE

No.	length		
52020	300 cm	steel	10



TELESCOPIC POLE

No.	length		
52030	240 cm	fiberglass	6



COVER TAPE SELF ADHESIVE WITH COVER SHEET

No.	width	length	
37243	55 cm	30 m	60
37244	110 cm	30 m	30
37245	140 cm	30 m	30
37246	180 cm	15 m	30
37290	210 cm	20 m	30
37247	240 cm	15 m	30
37291	270 cm	16 m	30



SAFETY OVERALL WITH HOOD

No.	specification	
50585	size M	1
50586	size L	1
50587	size XL	1
50588	size XXL	1



COVER SHEET FOR DOOR WITH ZIPPER

No.	specification	
37248	1,2 x 2,2 m tape 100 µm 45 mm x 25 m	25



COVER SHEET

No.	width	length	thickness	
37250	4 x 5 m	0,007 mm	100	
37251	4 x 12,5 m	0,007 mm	50	
37252	2 x 50 m	0,007 role	20	



COVER SHEET

No.	specification	thickness	
37253	4 x 5 m	0,03 mm	100



CORRUGATED CARDBOARD

No.	width	length	
54008	1 m	10 m	1

FESTA



TARPAULIN PROFESSIONAL

blue-silver

140 g/m²



No.	specification	
25206	2 x 3 m	25
25212	3 x 4 m	10
25215	3 x 5 m	8
25220	4 x 5 m	8
25224	4 x 6 m	8
25230	5 x 6 m	8

No.	specification	
25240	5 x 8 m	4
25248	6 x 8 m	3
25260	6 x 10 m	3
25296	8 x 12 m	2
25350	10 x 15 m	1



TARPAULIN EKONOMIK

blue



No.	specification	
25369	2 x 2 m	50
25370	2 x 3 m	20
25371	3 x 4 m	10
25372	3 x 5 m	10
25373	4 x 5 m	10

No.	specification	
25374	4 x 6 m	5
25376	5 x 8 m	5
25378	6 x 10 m	2
25379	8 x 12 m	2
25380	10 x 15 m	2

TARPAULIN STANDARD

blue-silver

70 g/m²



No.	specification	
25155	2 x 2 m	50
25006	2 x 3 m	50
25009	3 x 3 m	35
25012	3 x 4 m	20
25015	3 x 5 m	10
25016	4 x 4 m	10
25020	4 x 5 m	10
25024	4 x 6 m	10

No.	specification	
25025	5 x 5 m	10
25030	5 x 6 m	10
25040	5 x 8 m	5
25048	6 x 8 m	5
25060	6 x 10 m	5
25096	8 x 12 m	2
25150	10 x 15 m	2
25153	15 x 20 m	1

TARPAULIN STANDARD

green

70 g/m²



No.	specification	
25179	2 x 2 m	50
25180	2 x 3 m	50
25195	2 x 8 m	20
25181	3 x 4 m	20
25182	3 x 5 m	10
25183	4 x 5 m	10

No.	specification	
25184	4 x 6 m	10
25186	5 x 8 m	5
25188	6 x 10 m	5
25189	8 x 12 m	2
25190	10 x 15 m	2

TARPAULIN PROFESSIONAL

green-green

200 g/m²



No.	specification	
25160	2 x 3 m	15
25171	2 x 8 m	1
25162	3 x 5 m	5
25163	4 x 5 m	4

No.	specification	
25164	4 x 6 m	3
25167	6 x 8 m	2
25169	8 x 12 m	1
25170	10 x 15 m	1

TARPAULIN ROUND

blue-silver

120 g/m²



No.	specification	
25003	Ø 3,6 m	15
25004	Ø 4,5 m	5
25005	Ø 5,5 m	4
25002	Ø 6,5 m	3



TENSIONER FOR TARPAULINS

4x

No.	specification	
25400	20 cm	1



APPLICATOR OF EYELETS FOR PE TARPAULINS

No.	specification	
25410	applicator of eyelet + 25 eyelets	1

EYELETS FOR PE TARPAULINS

10x

No.	specification	
25001		1



TELESCOPIC LADDER FOLDABLE

· max. load 150 kg



No.	specification	
48415	1,9 / 3,8 m	6/12 steps

TELESCOPIC LADDER

· max. load 150 kg



No.	specification	
48410	3,2 m	11 steps
48411	3,8 m	13 steps

WORK PLATFORM, FOLDABLE

· max. load 150 kg



No.	specification	
48420		



NEW

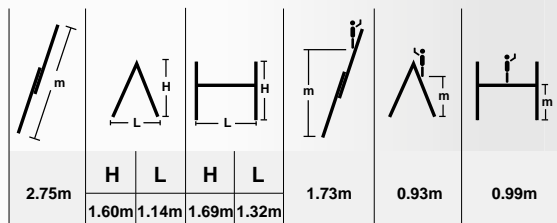

MULTIFUNCTION SCAFFOLD



· max 150 kg

No.	Specifications	
37660		



ADJUSTABLE SAW HORSE



No.	specification	
37545	140 cm, high 98 - 165 cm	1
37546	120 cm, high 98 - 165 cm	1



ADJUSTABLE PROPS

· 48449 cage for adjustable props



No.	specification	
48452	160 - 290 cm	1
48453	180 - 320 cm	1
48454	200 - 360 cm	1
48455	250 - 440 cm	1
48456	260 - 380 cm	1
48457	220 - 400 cm	1

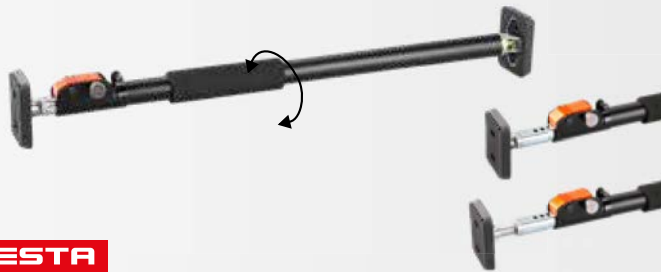

FESTA

SUPPORTING POLE

· max. load 40 kg

No.	specification		
52060	66 - 115 cm	1	
52065	160 - 290 cm	1	



NEW

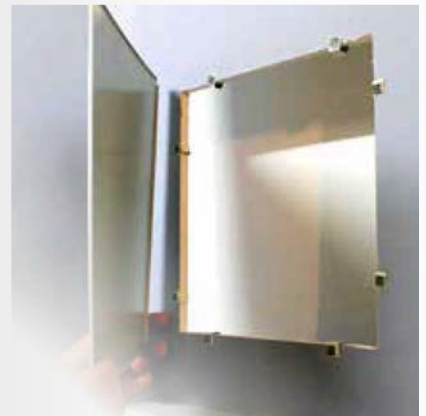

REVISION DOOR FOR DRYWALL AND MASONRY

	No.	specifications	
	82100	10 - 21 cm	1
	82101	20 - 31 cm	1
	82102	30 - 41 cm	1
	82103	40 - 51 cm	1
	82104	50 - 58 cm	1

SUPPORTING POLE

No.	specification		
52050	50 - 115 cm	1	
52055	115 - 290 cm	1	



CHIMNEY DOORS TIN



No.	specification	
65062		1



CHIMNEY DOORS KOMAX



No.	specification	
65063	šedá	1
65064	bílá	1



CHIMNEY DOORS GALVANIZED



No.	specification	
65065		1

 <p>310 WINLAND GARDEN PRUNERS</p>	 <p>312 GARDEN PRUNERS</p>	 <p>315 MACHETES AND GARDEN TOOLS</p>
 <p>315 GARDEN SAWS</p>	 <p>316 AXES</p>	 <p>318 GARDEN TOOLS</p>
 <p>320 SHARPENERS</p>	 <p>321 TRIMMER LINES</p>	 <p>321 BONDED WEB FABRIC</p>
 <p>322 GARDEN SUPPORTING BAR</p>	 <p>324 WATERING SYSTEM AQUATIC AND ROSA</p>	 <p>332 HOSE CONNECTORS BRAS</p>
 <p>333 HOSE REELS AND HOSE CARTS</p>	 <p>334 HOSE CONNECTORS</p>	 <p>335 PRESURE SPRAYER AND COMPRESSORS</p>
 <p>337 RAKE</p>	 <p>341 SPADES, SHOVELS AND FORKS</p>	 <p>348 BRUSHES</p>
 <p>350 WOODEN, ALU AND FIBERGLASS BUTT</p>	 <p>352 INSECT SCREEN</p>	 <p>353 FENCES</p>
 <p>356 POLE ANCHOR AND ANCHORAGE SCREW</p>	 <p>357 SHADING NETS</p>	 <p>358 GRILL TOOLS</p>



GARDEN TOOLS
AND FENCING

308 - 359





WINLAND®
PRUNERS



∅ max. 20 mm SK5



No.	dimensions	quantity
45020	205 mm	10
44980	spare spring	1



WINLAND®
PRUNERS



∅ max. 6 mm SK5



No.	dimensions	quantity
45023	205 mm	10
44980	spare spring	1



WINLAND®
PRUNERS



∅ max. 20 mm SK5



No.	dimensions	quantity
45063	215 mm	10
44981	spare spring	1



WINLAND®
PRUNERS



∅ max. 20 mm SK5 TEFLON



No.	dimensions	quantity
44972	215 mm	10
44981	spare spring	1



WINLAND®
PRUNERS



∅ max. 18 mm SK5



No.	dimensions	quantity
45099	190 mm	10
44983	spare spring	1



WINLAND®
PRUNERS



∅ max. 20 mm SK5



No.	dimensions	quantity
45098	220 mm	10
44983	spare spring	1



WINLAND®
PRUNERS



∅ max. 24 mm SK5 TEFLON



No.	dimensions	quantity
45095	200 mm	10
44982	spare spring	1



WINLAND®
PRUNERS



∅ max. 24 mm SK5 TEFLON



No.	dimensions	quantity
45096	220 mm	6
44982	spare spring	1



PRUNERS



INOX max. mm INOX

No. 45089 dimensions 160 mm



10



PRUNERS



SK5 TEFLON SK5 TEFLON

No. 45097 dimensions 210 mm
44981 spare spring 1



10

1



PRUNERS



INOX max. 10 mm

No. 45088 dimensions 160 mm



10



PRUNERS

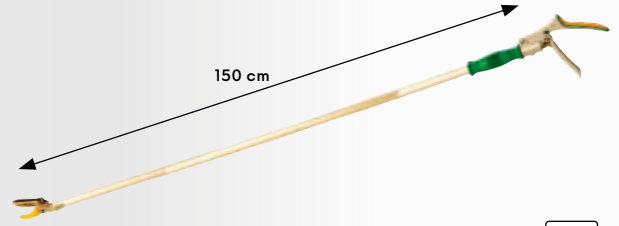

max. 12 mm

No. 45017 dimensions 10



10



SPARE SPRING



No.	for pruners	
44981	45021, 45025, 45063, 45097	1
44980	45020, 45023	1
44983	45098, 45099	1
44982	45027, 45095, 45096	1
44984	45110, 45014, 45026	1
44985	45018	1



SPARE BLADE



for pruners 45095, 45027

No. 45094 dimensions 20



20



PRUNERS FOR BRANCHES



max. 45mm SK5 TEFLON

No. 44991 dimensions 76 cm

12



PRUNERS FOR BRANCHES TELESCOPIC



max. 45mm SK5 TEFLON

No. 44992 dimensions 70 - 103 cm

10



PRUNERS



No.	dimensions	
44996	61 cm, wavy edge	12



PRUNERS



No.	dimensions	
44997	61 cm, straight edge	12



SHEARS GRASS 360°



No.	dimensions	
44998		6



SHARPENER FOR SCISSORS AND KNIVES 6 IN 1



No.	dimensions	
45068		10



SHARPENER FOR SCISSORS AND KNIVES



No.	dimensions	
45048		20

FESTA PRUNERS

· nylon handle



No.	dimensions	
45021	210 mm	6

PRUNERS



No.	dimensions	
45019	210 mm	10



FESTA

PRUNERS

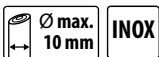

No.	dimensions	
45010	190 mm	12
44984	Spare spring	1

PRUNERS

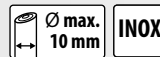

No.	dimensions	
45014	190 mm	12
44984	Spare spring	1

PRUNERS



No.	dimensions	
45026	150 mm	12
44985	Spare spring	1

PRUNERS



No.	dimensions	
45018	210 mm metal tipped	10

PRUNERS

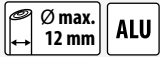

No.	dimensions
45025	200 mm



PRUNERS



No.	dimensions
44970	210 mm



PRUNERS

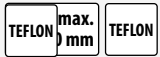

No.	dimensions
45027	200 mm



PRUNERS



No.	dimensions
45029	200 mm



PRUNERS

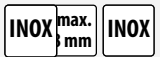

No.	dimensions
44971	160 mm



PRUNERS

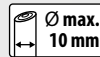

No.	dimensions
45016	180 mm



PRUNERS

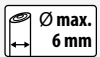

No.	dimensions
45015	190 mm, straight



CASE FOR GARDEN PRUNERS



No.	dimensions
37317	



GRASS SHEARS

No.	dimensions
45011	300 mm



GRASS SHEARS

No.	dimensions
45012	370 mm, turning 180°



PRUNERS FOR BRANCHES



No.	dimensions
44999	540 mm, round



FESTA

PRUNERS FOR BRANCHES



∅ max. 30 mm
TEFLON

No.	dimensions	
45000	750 mm, round	6

FESTA

PRUNERS FOR BRANCHES



∅ max. 25 mm
TEFLON

No.	dimensions	
45001	710 mm, round	6

FESTA

PRUNERS FOR BRANCHES



∅ max. 40 mm
TEFLON

No.	dimensions	
45002	750 mm, with ratchet	12

PRUNERS FOR BRANCHES, TELESCOPIC



∅ max. 30 mm
TEFLON

No.	dimensions	
45003	660-900 mm, telescopic	6

FESTA

PRUNERS FOR BRANCHES



∅ max. 6 mm
TEFLON

No.	dimensions	
45005	580 230 mm, wavy edge	6

FESTA

PRUNERS FOR BRANCHES



∅ max. 6 mm
TEFLON

No.	dimensions	
45006	580 230 mm, straight edge	6

FESTA

PRUNERS FOR BRANCHES TELESCOPIC



∅ max. 6 mm
TEFLON

No.	dimensions	
45007	670-870 230 mm, wavy edge	6

PRUNERS



∅ max. 10 mm
TEFLON
NYLON

No.	dimensions	
44995	440 160 mm	12

PRUNERS



No.	dimensions	
45009	500 190 mm, wavy edge	6

PRUNERS



No.	dimensions	
45008	500 190 mm, straight edge	6

SICKLE



No.	dimensions	
45490	450 mm	1



FESTA
MACHETE



TEFLON

No.	dimensions	
45069	440 mm	6

FESTA
MACHETE



TEFLON

No.	dimensions	
44950	490 mm	4

MACHETE
STAINLESS
STEEL

INOX



No.	dimensions	
45083	430 mm	12
45084	600 mm	6

MACHETE



· handle made out of ash wood

No.	dimensions	
45081	510 mm	36
45082	710 mm	36

FESTA
FOLDING SAW

1 2 3 · 3 x sharpened and heat treated teeth

No.	specification	
45061	150 mm with cover of handle	12



FESTA
FOLDING SAW

1 2 3 · 3 x sharpened and heat treated teeth

No.	specification	
45060	180 mm	6



FESTA
SAW WITH CASE

1 2 3 · 3 x sharpened and heat treated teeth

No.	specification	
45062	260 mm with case	24



FESTA
PRUNING HAND SAW

1 2 3 · 3 x sharpened and heat treated teeth

No.	specification	
24152	350 mm 7 tpi	12



FESTA
TELESCOPIC POLE SAW

1 2 3 · 3 x sharpened and heat treated teeth

No.	specification	
45033	230 - 490 mm	1



CATTERPILAR
WITH SAW

No.	specification	
45030	saw 30 cm	6
45031	saw 30 cm	6



CATTERPILAR

No.	specification	
45032	metal catterpillar without saw	6





FESTA

FESTA

AXE

DIN 5131 **DIN 7294**

- ash handle
- circular wedge



No.	specification		No.	specification	
19380	600 g	1	19384	1400 g	1
19381	800 g	1	19385	1600 g	1
19382	1000 g	1	19387	2000 g	1
19383	1250 g	1			

FESTA

CANPERTERS AXE

- ash handle



No.	specification	
19340	700 g	22

FESTA

AXE

- ash handle
- circular wedge

DIN 5129	No.	specification	
	19389	3000 g	1
	19388	4000 g	1



FESTA

SPLITTING AXE

- ash handle
- circular wedge

DIN 7294		No.	specification	
		19391	2000 g	1



FESTA

AXE FIBERGLASS

- fiberglass handle

Č.p.	specifikace	
19326	600 g	6
19328	800 g	24
19330	1000 g	12
19332	1250 g	8
19333	1500 g	6
19335	1600 g	6
19337	2000 g	6



FESTA

SPLITTING AXE FIBERGLASS

- fiberglass handle

Č.p.	specifikace	
19392	1000 g	6



FESTA

CAMP AXE FIBERGLASS

- fiberglass handle

Č.p.	specifikace	
19301	500 g	6



FESTA

SPLITTING AXE FIBERGLASS

- fiberglass handle

No.	specification	
19390	2000 g	6





FESTA

AXE FIBERGLASS

· fiberglass handle

No.	specification	
19370	3000 g	4
19371	4000 g	4



ASH HANDLE FOR AXE



Č.p.	specifikace	pro sekeru	
61340	36 cm	19380	10
61341	40 cm	19381, 19340	10
61342	50 cm	19382	10
61343	70 cm	19383, 19384	10
61344	80 cm	19385, 19391	10
61345	90 cm	19387	10
61346	90 cm	19388, 19389	10

AXE

Č.p.	specifikace	
19306	600 g	24
19308	800 g	24
19310	1000 g	24
19312	1250 g	12
19314	1500 g	12



SPLITTING WEDGE

No.	specification	
19397	2000 g 55 x 210 x 45 mm	10
19465	2500 g 65 x 230 x 45 mm	10



SPLITTING WEDGE



No.	specification	
19462	175 x 65 x 20 mm	1
19463	230 x 70 x 30 mm	1
19464	240 x 75 x 40 mm	1



SPLITTING WEDGE

No.	specification	
19394	1000 g 35 x 180 x 40 mm	6
19395	2000 g 40 x 255 x 55 mm	6
19396	2500 g 40 x 260 x 55 mm	8



SPLITTING MANDREL SDS+

No.	Specification	
19393	Ø 32 x 132 mm	10
19374	Ø 42 x 145 mm	10



SPLITTING WEDGE FOUR-SPOKE

No.	specification	
19469	2500 g 165 x 87 mm	10

SHOVEL
STAINLESS



No.	dimensions	
45056	360 mm	12

SHOVEL
NARROW
STAINLESS



No.	dimensions	
45057	360 mm	12

HACK
STAINLESS



No.	dimensions	
45058	270 mm	12

HACK
STAINLESS



No.	dimensions	
45059	360 mm	12

SHOVEL
NYLON



No.	dimensions	
45065	280 mm	1

SHOVEL
NARROW
NYLON



No.	dimensions	
45066	310 mm	1

FORK
NYLON



No.	dimensions	
45067	290 mm	1

TOOLS



No.	dimensions	
45035	240 mm	35

HOE
WITH HANDLE



No.	dimensions	shaft length	
61294	140 mm	27 cm	MOQ 3
61221	handle	27 cm	1

HOE
WITH HANDLE



No.	dimensions	shaft length	
61295	140 mm	27 cm	MOQ 3
61221	handle	27 cm	1

HOE
WITH HANDLE



No.	dimensions	shaft length	
61296	175 mm	27 cm	MOQ 3
61221	handle	27 cm	1

HOE
WITH HANDLE



No.	dimensions	shaft length	
61297		27 cm	MOQ 3
61221	handle	27 cm	1



FOLDING SHOVEL 3 IN 1

case		
No.	dimensions	
61085	410 mm	6



BULB PLANER

INOX		
No.	dimensions	
45040	230 mm	60



"T" PLANTING DOSSIL

No.	dimensions	
45038	280 mm	60



WEED KNIFE

No.	dimensions	
45079	200 mm	1



WEED KNIFE

No.	dimensions	
45080	200 mm „L“	1



FRUIT PICKER

No.	dimensions	
45041		75



FRUIT PICKER

No.	dimensions	
45039		50
45034	170 - 300 cm, telescopic but	5



PLUCKING FOR WEED

No.	dimensions	
44955	950 mm	16



CULTIVATOR

No.	dimensions	
45042	160 x 132 cm	12



CULTIVATOR

No.	dimensions	
44053		12
61251	160 cm handle	1



SPREADING CART

DIMENSIONS	
height:	111 cm
wide:	55 cm
volume:	12 l

No.	dimensions	
45085	12 l	1

FESTA

SHARPENER FOR KNIVES AND SCISSORS 16v1



	30° Anvil	
	45° Anvil	
	50° Anvil	
	23° Bypass	
	35° Bypass	
	65° Bypass	
	Deburrr Tool	



No.	specifications	
45073		1



SHARPENER FOR KNIVES AND SCISSORS 6 IN 1

No.	dimensions	
45068		10



SHARPENER FOR KNIVES AND SCISSORS

No.	dimensions	
45048		20



WHETSTONE

No.	dimensions	
45046	205 x 15 mm	100



WHETSTONE OVAL

No.	dimensions	
45370	250 x 33 x 18 mm	20



WHETSTONE

No.	dimensions	
45045	150 x 50 x 30 mm	50



SHARPENER FOR KNIVES AND SCISSORS

No.	dimensions	
16991		20



SHARPENER FOR KNIVES AND SCISSORS

No.	dimensions	
16990	Ø 50 mm	50





TRIMMER LINES FOW LAWN-MOVER WITH NYLON CENTER



No.		dimensions	
45530	■	2 mm x 15 m	1
45531	■	2,4 mm x 15 m	1
45532	■	3 mm x 15 m	1
45533	■	3,15 mm x 15 m	1
45534	■	4 mm x 15 m	1

TRIMMER LINES FOW LAWN MOVER



No.		dimensions	
45500	●	1,3 mm x 15 m	30
45502	●	1,3 mm x 15 m	30
45503	●	1,6 mm x 15 m	20
45505	●	1,6 mm x 15 m	20
45506	●	2 mm x 15 m	12
45508	●	2 mm x 15 m	12
45517	●	2 mm x 15 m	10
45509	●	2,4 mm x 15 m	12
45511	●	2,4 mm x 15 m	12
45512	■	2,4 mm x 15 m	12
45518	■	2,4 mm x 15 m	10
45523	●	2,7 mm x 15 m	10
45524	●	2,7 mm x 15 m	10
45513	●	3 mm x 15 m	10
45515	●	3 mm x 15 m	10
45516	■	3 mm x 15 m	10
45519	■	3 mm x 15 m	10

TRIMMER LINES FOW LAWN MOVER

No.		dimensions	
45520	●	2 mm x 162 m	10
45521	●	2,4 mm x 112 m	10
45528	●	2,7 mm x 90 m	10
45522	●	3 mm x 72 m	10
45525	●	2 mm x 162 m	10
45526	●	2,4 mm x 112 m	10
45529	●	2,7 mm x 90 m	10
45527	●	3 mm x 72 m	10



MULCHING FABRIC



No.	dimensions	
45550	1,6 x 5 m	50
45551	1,6 x 10 m	20
45564	3,2 x 10 m	20
45552	1,6 x 50 m	in a role 1
45553	1,6 x 100 m	in a role 1
45562	3,2 x 50 m	in a role 1
45563	3,2 x 100 m	in a role 1



MULCHING FABRIC

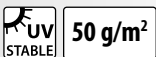

No.	dimensions	
45556	1,6 x 5 m	50
45557	1,6 x 10 m	20
45565	3,2 x 10 m	20
45558	1,6 x 50 m	in a role 1
45559	1,6 x 100 m	in a role 1

BONDED WEB FABRIC WHITE

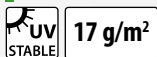

No.	dimensions	
45540	1,6 x 5 m	40
45541	1,6 x 10 m	40
45542	1,6 x 50 m	in a role 1
45543	1,6 x 100 m	in a role 1

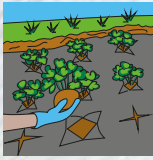

BONDED WEB FABRIC WITH SECTIONS FOR PLANTS

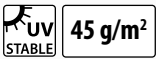

No.	dimensions	
45535	1,6 x 5 m	18



PIN FOR ATTACHING MULCHING FABRIC



No.	dimensions	
45555	11,5 cm	1

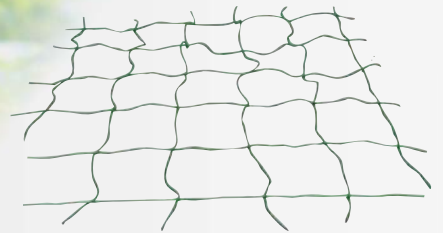

CUCUMBER NET

No.	dimensions	eye size	
45560	2 x 10 m	10 x 10 cm	100



BINDING TAPES - TOOTHED



GARDEN BAR FIBERGLASS

No.	dimensions	
45036	180 cm Ø 7,9 mm	100

No.	dimensions	
23840		20



GARDEN BAR

No.	dimensions		No.	dimensions		No.	dimensions	
45650	90 cm Ø 8 mm	25	45655	150 cm Ø 11 mm	25	45659	180 cm Ø 16 mm	25
45651	120 cm Ø 8 mm	25	45656	180 cm Ø 11 mm	25	45660	210 cm Ø 16 mm	25
45652	150 cm Ø 8 mm	25	45661	210 cm Ø 11 mm	25	45662	150 cm Ø 20 mm	10
45653	90 cm Ø 11 mm	25	45657	120 cm Ø 16 mm	25	45663	180 cm Ø 20 mm	10
45654	120 cm Ø 11 mm	25	45658	150 cm Ø 16 mm	25	45664	210 cm Ø 20 mm	10



SPIRAL GARDEN BAR

No.	dimensions		
44041	1,2 m, Ø 5,5 mm	komaxit - green	10
44042	1,5 m, Ø 6 mm	komaxit - green	10
44043	1,8 m, Ø 6 mm	komaxit - green	10
45049	1,8 m, Ø 7 mm	komaxit - green	10
45044	1,8 m, Ø 7 mm	komaxit - silver	10
44050	2,2 m, Ø 7 mm	komaxit - green	10



GARDEN BAR FIBERGLASS



No.	dimensions	
45670	8 mm	10
45671	11 mm	10
45672	16 mm	10
45673	20 mm	10



BINDING TAPE, VELCRO

No.	dimensions	
45471	12 mm x 5 m	1

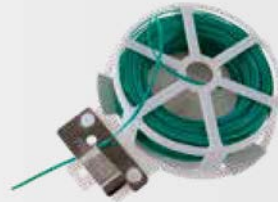

BINDING WIRE

No.	dimensions	
45043	30 m	30



BINDING WIRE RUBBERCOATING

No.	dimensions	
23845	3 mm x 8 m	30
23846	4 mm x 6 m	30
23847	5 mm x 4 m	30



BINDING TAPE

No.	dimensions	
45472	3 cm x 3 m, 3 ks	36



BINDING TAPE

No.	dimensions	
45473	3 cm x 50 m	60



KNEELER

No.	dimensions	
45086	40 x 18 x 2 cm	50



GARDEN FOLDING CHAIR

· for sitting and upside down for kneeling

No.	dimensions	
45074	58 x 48 x 28 cm	4



FOLDING BASKET

No.	dimensions	
45093	40 x 25 x 23 cm	10



BUCKET



No.	dimensions	
39192	26 l	20
39193	42 l	20



FOLDING BASKET FOR LEAVES

No.	dimensions	
45047	55 x 70 cm, 3 handles	20



FOLDING BASKET FOR LEAVES

No.	dimensions	
44960	200 l 60 x 60 x 55 cm	50



FESTA[®]
AQUATIC



FESTA[®]
AQUATIC
SPRAY GUN

- 7 functions
- front trigger with lock
- effortless flow control



No.	dimensions	
45386		12



FESTA[®]
AQUATIC
SPRAY GUN

- adjustable flowing
- front trigger with lock
- effortless flow control



No.	dimensions	
45388		12



FESTA[®]
AQUATIC
SPRINKLER

- adjustable flowing



No.	dimensions	
45389		24



FESTA[®]
AQUATIC
HOSE BASIC SET

- adjustable flowing



No.	dimensions	
45385	4 pcs	12



FESTA[®]
AQUATIC
HOSE CONNECTOR



No.	dimensions	
45390		24



FESTA[®]
AQUATIC
HOSE CONNECTOR



No.	dimensions	
45392		24



FESTA[®]
AQUATIC
STOP HOSE CONNECTOR



No.	dimensions	
45394		24



FESTA[®]
AQUATIC
HOSE CONNECTOR



No.	dimensions	
45391		24



FESTA[®]
AQUATIC
HOSE CONNECTOR



No.	dimensions	
45393		24



FESTA[®]
AQUATIC
STOP HOSE CONNECTOR



No.	dimensions	
45395		24

FESTA
AQUATIC

ADAPTER



No.	dimensions	
45396		24



NEW



FESTA
AQUATIC

GARDEN HOSE PROFI



No.	dimensions	
45372	1/2" 25 m	1
45373	1/2" 50 m	1
45374	3/4" 25 m	1
45375	3/4" 50 m	1
45376	1" 25 m	1
45377	1" 50 m	1



FESTA
AQUATIC

SPRINKLER

· 19 nozzles with 8 switchable (on/off) spray nozzles



No.	dimensions	
45398		6

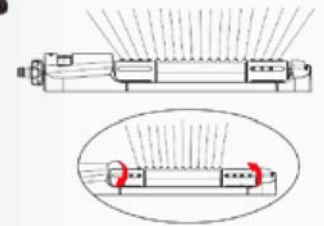

FESTA
AQUATIC

SPRINKLER

· adjustable arms with nozzles



No.	dimensions	
45399		12



FESTA
AQUATIC

WATER DISTRIBUTOR

· adjustable flow control



No.	dimensions	
45400		6



FESTA
AQUATIC

WATER DISTRIBUTOR

· adjustable flow control



No.	dimensions	
45401		6



ROSA
SPRAY GUN

- 10 functions
- front trigger with lock

0,7bar min
5,5bar max

No. dimensions 12  

45124



ROSA
SPRAY GUN

- 10 functions
- trigger with lock
- effortless flow control

0,7bar min
5,5bar max

No. dimensions 12  

45125





ROSA

Watering system

ROSA
SPRAY GUN

- 7 functions
- trigger with lock

0,7bar min
5,5bar max

No. dimensions 12  



45126



ROSA
SPRAY GUN, DELUX

- 7 functions
- trigger with lock
- effortless flow control

0,7bar min
5,5bar max

No. dimensions 12  

45123 metal



ROSA
SPRAY GUN

- 6 functions
- trigger with lock
- effortless flow control

0,7bar min
5,5bar max

No. dimensions 12  

45117



ROSA
SPRAY GUN, DELUX

- 6 functions
- trigger with lock
- effortless flow control

0,7bar min
5,5bar max

No. dimensions 12  

45118 metal head



ROSA
SPRAY GUN

- 5 functions
- trigger with lock
- effortless flow control

0,7bar min
5,5bar max

No. dimensions 12  



45110



ROSA
SPRAY GUN

- rose gun
- effortless flow control

0,7bar min
5,5bar max

No. dimensions 12  

45116



ROSA

SPRAY GUN

- metal head
- trigger with lock
- effortless flow control



No.	dimensions		
45120		12	



ROSA

SPRAY GUN

- trigger with lock
- effortless flow control



No.	dimensions		
45115		12	



ROSA

SPRAY GUN

- metal
- trigger with lock
- effortless flow control



No.	dimensions		
45122	metal	12	



ROSA

SPRAY GUN SET

- trigger with lock
- effortless flow control



No.	dimensions		
45114	1/2 hose connector	12	



ROSA

SPRAY GUN

- trigger with lock
- effortless flow control



No.	dimensions		
45111		12	



ROSA

SPRAY GUN SET

- 6 functions
- trigger with lock
- effortless flow control



No.	dimensions		
45181		12	



ROSA

SPRINKLER

- adjustable flowing



No.	dimensions		
45214		48	



ROSA

SPRINKLER

- stream lined, classic connection



No.	dimensions		
45112		32	



ROSA

SPRINKLER

- adjustable flowing



No.	dimensions		
45113		60	



ROSA

SET WITH SPRAY GUN

- adjustable flowing



No.	dimensions		
45180		12	



ROSA
HOSE MENDER

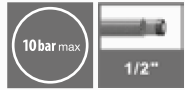

No. dimensions **45140** 60

ROSA
HOSE CONNECTOR



No. dimensions **45142** 60

ROSA
STOP HOSE CONNECTOR



No. dimensions **45138** 60

ROSA
HOSE MENDER

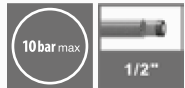

MOQ 20

No. dimensions **45296** MOQ 20

ROSA
HOSE CONNECTOR



MOQ 20

No. dimensions **45298** MOQ 20

ROSA
STOP HOSE CONNECTOR



MOQ 20

No. dimensions **45294** MOQ 20

ROSA
HOSE CONNECTOR

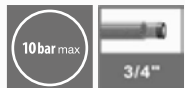

No. dimensions **45141** 60

ROSA
HOSE CONNECTOR



No. dimensions **45143** 60

ROSA
STOP HOSE CONNECTOR



No. dimensions **45139** 60

ROSA
HOSE CONNECTOR



MOQ 20

No. dimensions **45297** MOQ 20

ROSA
HOSE CONNECTOR



MOQ 20

No. dimensions **45299** MOQ 20

ROSA
STOP HOSE CONNECTOR



MOQ 20

No. dimensions **45295** MOQ 20

ROSA
REDUCTION 1/2" - 3/4"



No. dimensions **45213** 1/2" - 3/4" 60

ROSA
REDUCTION 3/4" - 1"



No. dimensions **45216** 1" - 3/4" 48

ROSA
HOSE CONNECTOR



No. dimensions **45218** 1" 48

ROSA
ADAPTER



10 bar max	1/2"	3/4"	1"
No.	dimensions		
45130	1/2" + 3/4"	60	
45131	3/4" + 1"	60	

ROSA
ADAPTER



10 bar max	1"	3/4"	1"
No.	dimensions		
45217		48	

ROSA
HOSE CONNECTOR



10 bar max	1"	
No.	dimensions	
45219		48

ROSA
ADAPTER



10 bar max	1/2"	3/4"	1"	MOQ 20
No.	dimensions			
45289	1/2" + 3/4"	MOQ 20		
45290	3/4" + 1"	MOQ 20		

ROSA
HOSE CONNECTOR SET



2x	10 bar max	1/2"	3/4"
No.	dimensions		
45144		60	

ROSA
ONE-WAY SWITCH COUPLING
with water valve



6,9 bar max	3/4"	
No.	dimensions	
45135		60

ROSA
ADAPTER



10 bar max	3/4"	
No.	dimensions	
45133		60

ROSA
ADAPTER



10 bar max	3/4"	
No.	dimensions	
45132		60

ROSA
ADAPTER



10 bar max		
No.	dimensions	
45136		60

ROSA
ADAPTER



10 bar max	3/4"	MOQ 20
No.	dimensions	
45292		MOQ 20

ROSA
ADAPTER



10 bar max	3/4"	MOQ 20
No.	dimensions	
45291		MOQ 20

ROSA
ADAPTER



10 bar max	MOQ 20	
No.	dimensions	
45293		MOQ 20

ROSA
ADAPTER



10 bar max		
No.	dimensions	
45137		60

ROSA
ADAPTER



10 bar max	1"	
No.	dimensions	
45215		48

ROSA
ADAPTER



10 bar max	1/2"	
No.	dimensions	
45145		60

ROSA

**Y - SWITCH
COUPLING
SWIVEL**

· with water valve

0,7 bar min
5,5 bar max

No. dimensions 45134 12



ROSA

SALES SET

· content of set

- 45113 15 ks
- 45117 10 ks
- 45120 15 ks
- 45132 40 ks
- 45131 40 ks
- 45133 40 ks
- 45142 25 ks
- 45143 20 ks
- 45140 20 ks

225x

No. dimensions 45146 1



ROSA

**SPRINKLER
IMPULS**

· impulse

0,7 bar min
5,5 bar max

No. dimensions 45162 24



ROSA

SPRINKLER

· function

0,7 bar min
5,5 bar max

No. dimensions 45154 48



ROSA

SPRINKLER

· rotary
· 2 arms

0,7 bar min
5,5 bar max

No. dimensions 45153 24



ROSA

SPRINKLER

· rotary
· 3 arms

0,7 bar min
5,5 bar max

No. dimensions 45152 24



ROSA

**SPRINKLER
SWINGING**

· 17 jets ALU

0,7 bar min
5,5 bar max

ALU

No. dimensions 45158 6

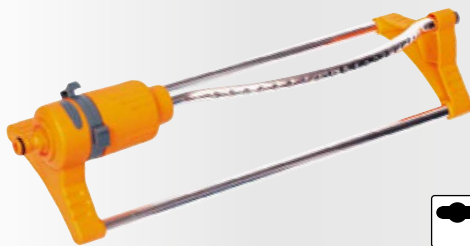

ROSA

SPRINKLER

· pyramidal

0,7 bar min
5,5 bar max

No. dimensions 45167 12



ROSA

**STAND FOR
IMPULSE
SPRINKLER**

0,7 bar min
5,5 bar max

3/4"

No. dimensions 45155 24



ROSA

**SPLINKER,
IMPULSE**

· tripod

0,7 bar min
5,5 bar max

No. dimensions 45163 impulse, tripod 20



ROSA

SPRINKLER

· point

No.	dimensions	
45160		25



ROSA

SPRINKLER

· pot sprinkler with valve

No.	dimensions	
45156		12



ROSA

WATER TIMER

· 0 - 120 min.

No.	dimensions	
45147		24



ROSA

SPRINKLER, IMPULS

· brass

No.	dimensions	
45150		12



ROSA

SPRINKLER, IMPULSE

No.	dimensions	
45151		12



ROSA

SPRINKLER, IMPULSE, POINT

No.	dimensions	
45168	plastic spike	12
45169	metal spike	12



ROSA

SPRINKLER, IMPULSE, POINT

No.	dimensions	
45161	plastic spike	20



ROSA

SPRINKLER, ROTARY, POINT

· 3 arms
· two-ways

No.	dimensions	
45164	plastic spike	12



ROSA

SPIKE STAND

No.	dimensions	
45159		12



ROSA

SPIKE STAND

No.	dimensions
45179	



ROSA

HOSE GUIDE

No.	dimensions
45186	



ROSA

SPRINKLER, IMPULS

No.	dimensions
45185	



ROSA

SPRINKLER, IMPULS

No.	dimensions
45184	



ROSA

HOSE MENDER BRASS



No. dimensions
45192 1/2"

48

ROSA

HOSE CONNECTOR BRASS



No. dimensions
45194 1/2"

48

ROSA

STOP HOSE CONNECTOR BRASS

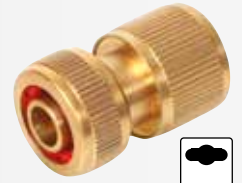

No. dimensions
45190 1/2"

48

ROSA

HOSE MENDER BRASS



No. dimensions
45193 3/4"

48

ROSA

HOSE CONNECTOR BRASS



No. dimensions
45195 3/4"

48

ROSA

STOP HOSE CONNECTOR BRASS



No. dimensions
45191 3/4"

48

ROSA

ADAPTER BRASS



No. dimensions
45196 with inward scroll 1/2" + 3/4" 48

ROSA

ADAPTER BRASS



No. dimensions
45197 with inward scroll 3/4" 48

48

ROSA

ADAPTER BRASS



No. dimensions
45199 with inward scroll 1" 48

48

ROSA

ADAPTER BRASS



No. dimensions
45198 with inward scroll 3/4 + 1" 48

48

ROSA

ADAPTER BRASS



No. dimensions
45200 with outward scroll 3/4 48

48

ROSA

ADAPTER BRASS



No. dimensions
45206 adjustable 48

48

ROSA

ADAPTER BRASS



No. dimensions
45203 connection for 2 hose connectors 48

48

ROSA

ADAPTER BRASS



No. dimensions
45204 connection for 3 hose connectors 48

48

HOSE ADAPTER WITH BRASS THREAD



No. dimensions
45211 inner thread 1" 25

25

ROSA

SEL SET

· for items
45110, 45111, 45118, 45120, 45121, 45123,
45125, 45126, 45130, 45131, 45132, 45134,
45135, 45152, 45153, 45154, 45155, 45156,
45162, 45177, 45178, 45180, 45196, 45197,
45198



No. dimensions
45175 1

1

ROSA

SEALING RING

50x

No. dimensions
45187 1

1



NEW



ROSA
GARDEN HOSE CLEAR



No.	dimensions	
45342	1/2" 10 m	1
45343	1/2" 15 m	1
45344	1/2" 20 m	1
45345	1/2" 25 m	1
45346	1/2" 50 m	1
45341	3/4" 10 m	1
45347	3/4" 15 m	1
45348	3/4" 20 m	1
45349	3/4" 25 m	1
45351	3/4" 50 m	1
45352	1" 15 m	1
45353	1" 25 m	1
45354	1" 50 m	1

NEW



FESTA AQUATIC
GARDEN HOSE PROFI



No.	dimensions	
45372	1/2" 25 m	1
45373	1/2" 50 m	1
45374	3/4" 25 m	1
45375	3/4" 50 m	1
45376	1" 25 m	1
45377	1" 50 m	1



ROSA
SPIRAL HOSE SET



No.	dimensions	
45300	7,5 m	6
45301	15 m	8



ROSA
HOSE HOLDER



No.	dimensions	
45178	1/2" 60 m	5



ROSA
HOSE CART METAL



No.	dimensions	
45183	1/2" 60 m	5



ROSA
HOSE CART



No.	dimensions	
45177	1/2" 60 m	5

ROSA
HOSE REEL



No.	dimensions		
45182	1/2" 40 m	4	60

ROSA
AUTO REWIND HOSE REEL

• hose included 1/2" 20 m



No.	dimensions		
45176		1	



ROSA
HOSE CARRIER

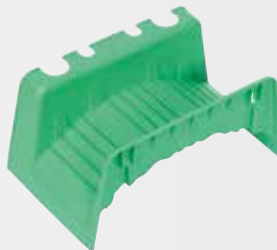

No.	dimensions	
45174		60

ROSA
HOSE CARRIER

• 1/2" garden plastic pipe, up to 30 m

No.	dimensions	
45350	Max. holding capacity 20 kg	1



HOSE MENDER

No.	dimensions	
45220	1/2" thread 3/4"	10
45221	3/4" thread 1"	10
45222	1" thread 1"	10



HOSE END

No.	dimensions	
45223	1/2" thread 3/4"	10
45224	3/4" thread 1"	10
45225	1" thread 1"	10



HOSE REDUCTION

No.	dimensions	
45226	1/2"- 3/4" thread 1"	10
45227	1" - 3/4" thread 1"	10
45228	1" - 1/2" thread 1"	10



SPRINKLER

No.	dimensions	
45229		10



No.	diameter	
45603	16 - 25 mm	2
45604	20 - 32 mm	2
45605	25 - 40 mm	2
45606	30 - 45 mm	2
45607	32 - 50 mm	2
45608	40 - 60 mm	2
45609	50 - 70 mm	2
45610	60 - 80 mm	2
45611	70 - 90 mm	2
45612	80 - 100 mm	2
45613	90 - 110 mm	2
45614	100 - 120 mm	2
45615	110 - 130 mm	2
45616	120 - 140 mm	2
45617	130 - 150 mm	2
45618	140 - 160 mm	2
45619	150 - 170 mm	2



No.	diameter	width	
45623	16 - 25 mm	9 mm	2
45624	20 - 32 mm	9 mm	2
45625	25 - 40 mm	12 mm	2
45626	30 - 45 mm	12 mm	2
45627	32 - 50 mm	12 mm	2
45628	40 - 60 mm	12 mm	2
45629	50 - 70 mm	12 mm	2
45630	60 - 80 mm	12 mm	2
45631	70 - 90 mm	12 mm	2
45632	80 - 100 mm	12 mm	2
45633	90 - 110 mm	12 mm	2
45634	100 - 120 mm	12 mm	2
45635	110 - 130 mm	12 mm	2
45636	120 - 140 mm	12 mm	2
45637	130 - 150 mm	12 mm	2
45638	140 - 160 mm	12 mm	2
45639	150 - 170 mm	12 mm	2

HOSE CLAMP

Zn **MOQ 2**

No.	diameter	
45600	8 - 12 mm	2
45601	10 - 16 mm	2
45602	12 - 20 mm	2

HOSE CLAMP

INOX **MOQ 2**

No.	diameter	width	
45620	8 - 12 mm	9 mm	2
45621	10 - 16 mm	9 mm	2
45622	12 - 20 mm	9 mm	2



DOUBLE WATER VALVE

No.	
45105	8



GARDEN VALVE

No.	dimensions	
45100	1/2"	12
45101	3/4"	10
45102	1"	6



BALL VALVE

No.	dimensions	
45106	1/2"	12
45107	3/4"	10
45108	1"	8



WATERING CAN PLASTIC



MADE IN EU

No.	dimensions	
45280	2,5	10
45283	5	10
45285	10	10
45286	12	10
45287	15	10

CORNER VALVE

No.	dimensions	
45104	1/2" x 3/8"	10



FESTA

PRESSURE SPRAYER 12 L

max. pressure:	2,5 Bar
volume:	12 l
length of hose	3 m
dimensions:	32 x 25 x 59 cm



No.	dimensions	
45249	pressure sprayer 12 l	1

FESTA

PRESSURE SPRAYER

No.	dimensions	
45247	12 l	1
45248	16 l	1

No.	dimensions	
45263	spare hose	1
45251	spare set of selling	1
45254	spare nozzle	1
45257	spare handle	1
45261	spare pole - 370 mm	1
45267	spare pole 45 - 250 cm	1
45268	spare pole 65 - 260 cm	1



FESTA

PRESSURE SPRAYER

No.	dimensions	
45244	3 l	6
45245	5 l	6
45246	8 l	6

No.	dimensions	
45262	spare hose	1
45250	spare set of selling	1
45253	spare nozzle	1
45256	spare handle	1
45260	spare pole - 370 mm	1



• suitable for : 45244, 45245, 45246



• suitable for : 45247, 45248

TELESCOPIC POLE FOR PRESSURE SPRAYER

No.	typ	
45267	45 - 250 cm	inox 1
45268	65 - 260 cm	fiberglass 1

93 - 250 cm



TELESCOPIC SPRINKLER

No.	dimensions	
45269		1



SPARE HOSE FOR PRESSURE SPRAYER

No.	typ	
45263	for sprayer 45247, 45248	1
45262	for sprayer 45244, 45245, 45246	1



HERBICID BELL

No.	dimensions	length	width	height	
45265	small	230 mm	90 mm	130 mm	1
45266	big	370 mm	140 mm	200 mm	1



FESTA

**PRESSURE
HAND
SPRAYER**



No.	typ	
45242	1,5 l	20
45241	2 l	20

HAND SPRAYER

MADE IN
EU



No.	typ	
45239	0,5 l	1
45240	0,7 l	1



ROSA
SHOWER

0,7bar min
5,5bar max

No.	dimensions	
45171	adjustable	12



ROSA
SHOWER

0,7bar min
5,5bar max

No.	dimensions	
45170	tripod	6



ROSA
**HAND
SHOWER**

0,7bar min
5,5bar max

No.	dimensions	
45172	with valve	12
45173	10 function	12



FESTA[®]

system click
ON - OFF



system click
ON - OFF

FESTA

PLASTIC RAKE

No.	no. lamellas	width	height	
45327	13	240 mm	200 mm	12



system click
ON - OFF

FESTA

PLASTIC RAKE

No.	no. lamellas	width	
45325	12	410 mm	12



system click
ON - OFF

FESTA

PLASTIC RAKE

No.	no. lamellas	width	height	
45328	23	480 mm	280 mm	12



system click
ON - OFF

FESTA

PLASTIC RAKE

No.	no. lamellas	width	
45326	18	580 mm	12



system click
ON - OFF

FESTA

PLASTIC RAKE

No.	no. lamellas	width	height	
45329	35	760 mm	310 mm	1



system click
ON - OFF

FESTA

BRUSH

No.	dimensions	
45323	37 cm	16

FESTA

HANDLE

ALU



system click
ON - OFF

No.	dimensions	
45330	161 cm	24
45331	100 cm	24



FESTA

METAL RAKE
ADJUSTABLE,
TELESCOPIC



Zn

No.	no. lamellas	rozsah	
44965	15	200 - 590 mm	12

METAL RAKE ADJUSTABLE



Zn

No.	no. lamellas	váha	rozsah	
45050	15	1200 g	200 - 590 mm	25

FESTA

METAL RAKE
· spring steel

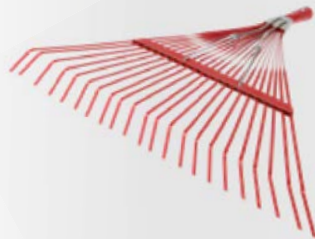

No.	width	no. lamellas	
45071	55 cm	22	1

FESTA

METAL RAKE
WITH
HANDLE



MOQ
3

No.	width	shaft length	
61150	55 cm	160 cm	3



METAL RAKE
WITH
HANDLE



MOQ
3

METAL RAKE

No.	width	no. lamellas	
45051	40 cm	22	60

No.	width	shaft length	
61130	40 cm	160 cm	3



METAL RAKE
WITH HANDLE



MOQ
3

METAL RAKE - WIRE

No.	width	no. lamellas	
45052	45 cm	22	36

No.	width	shaft length	
61131	45 cm	160 cm	3

PLASTIC RAKE



No.	width	no. lamellas	
45320	60 cm	24	10

PLASTIC RAKE WITH HANDLE



No.	width	no. lamellas	shaft length	
61132	60 cm	24	160 cm	3



PLASTIC RAKE



No.	width	no. lamellas	
45055	50 cm	22	10

PLASTIC RAKE WITH HANDLE



No.	width	no. lamellas	shaft length	
61133	50 cm	22	160 cm	3



PLASTIC RAKE



No.	width	no. lamellas	
45321	40 cm	23	20

PLASTIC RAKE WITH HANDLE



No.	no. lamellas	shaft length	
61134	23	160 cm	3



PLASTIC RAKE



No.	width	no. lamellas	
45054	40 cm	23	10

PLASTIC RAKE WITH HANDLE



No.	width	no. lamellas	shaft length	
61135	40 cm	23	160 cm	3



PLASTIC RAKE



No.	width	no. lamellas	
45053	58 cm	16	35

PLASTIC RAKE WITH HANDLE



No.	width	no. lamellas	shaft length	
61141	58 cm	16	160 cm	3



PLASTIC RAKE WITH ALIGNMENT EDGE



No.	width	no. teeth	
45070	41 cm	14	4

PLASTIC RAKE WITH HANDLE ALIGNMENT EDGE



MOQ
3

No.	width	no. teeth	shaft length	
61142	41 cm	14	160 cm	3

METAL RAKE



No.	width	no. teeth	
61030	24 cm	10	24
61031	29 cm	12	24
61032	34 cm	14	24
61033	40 cm	16	24

METAL RAKE WITH HANDLE



MOQ
3

No.	width	no. teeth	shaft length	
61060	24 cm	10	160 cm	3
61061	29 cm	12	160 cm	3
61062	34 cm	14	160 cm	3
61063	40 cm	16	160 cm	3

RAKE VERTICUTATION METAL

· hammer paint



No.	width	no. teeth	
61045	30 cm	12	25
61046	39 cm	14	25
61047	45 cm	16	25

RAKE WITH WOODEN HANDLE



· hammer paint

MOQ
3

No.	width	no. teeth	shaft length	
61143	30 cm	12	160 cm	3
61144	39 cm	14	160 cm	3
61145	45 cm	16	160 cm	3

RAKE ARETATION



No.	width	no. teeth	
61048	35 cm	11 21	12

RAKE ARETATION WITH HANDLE



MOQ
3

No.	width	no. teeth	shaft length	
61146	35 cm	11 21	160 cm	3

METAL RAKE WITH HANDLE FIBERGLASS



MOQ
3

No.	width	no. teeth	shaft length	
61034	34 cm	14	160 cm	3



FESTA

SPADE POINTED



No.	dimensions	shaft length	
61006	19 x 28 cm	120 cm	5

FESTA

SPADE POINTED SMALL

· suitable for work in the greenhouse



No.	dimensions	shaft length	
61008	19 x 28 cm	85 cm	5

FESTA

SPADE ROUND



No.	dimensions	shaft length	
61005	20 x 29 cm	120 cm	5

FESTA



FESTA

SPADE ROUND, EXTENDED

· for person higher than 180 cm

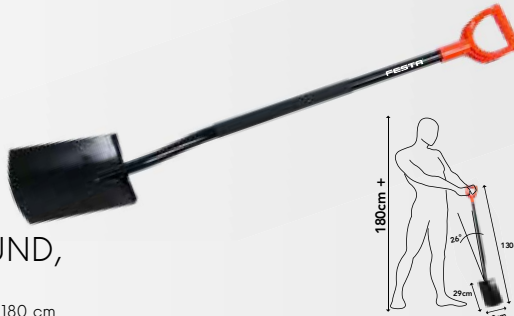

No.	dimensions	shaft length	
61157	20 x 29 cm	130 cm	5

FESTA

SPADE POINTED, EXTENDED

· for person higher than 180 cm

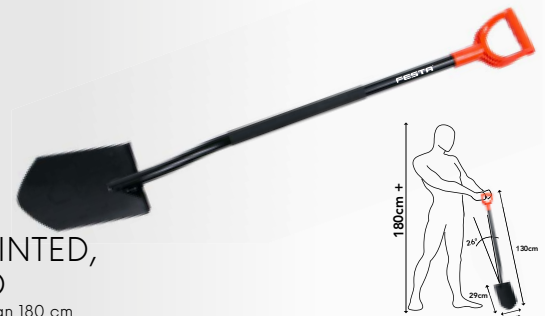

No.	dimensions	shaft length	
61158	19 x 28 cm	130 cm	5

FESTA

SHOVEL STANDARD



No.	dimensions	shaft length	
61155	24 x 29 cm	120 cm	5

FESTA

FORK



No.	dimensions	shaft length	
61156	19 x 28 cm	130 cm	5

FESTA

FORK



No.	dimensions	shaft length	
61007	18 x 28 cm	130 cm	5

FORK, FIBERGLASS HANDLE



No.	dimensions	shaft length	
61010	18 x 30 cm	95 cm	12

SPADE POINTED, FIBERGLASS HANDLE



No.	dimensions	shaft length	
61029	19 x 30 cm	105 cm	12

SPADE, FIBERGLASS HANDLE



No.	dimensions	shaft length	
61015	19 x 30 cm	105 cm	12



ALU SHOVEL WITH HANDLE

· beech handle with knuckle

ALU

MOQ
3

No.	dimensions	shaft length	
61057	26 x 29 cm	130 cm	3
61056	34 x 30 cm	130 cm	3



SHOVEL COAL

ALU

No.	dimensions	
61026	26 x 29 cm	10
61025	34 x 30 cm	10



SHOVEL COAL WITH HANDLE

MOQ
3

No.	dimensions	shaft length	
61089	35 x 35 cm	130 cm	3



SHOVEL COAL

No.	dimensions	
61021	35 x 35 cm	10



ROUND SHOVEL WITH HANDLE

· hammer paint
· beech handle with knuckle

MOQ
3

No.	dimensions	shaft length	
61050	26 x 28 cm	130 cm	3



ROUND SHOVEL

· hammer paint

No.	dimensions	
61000	26 x 28 cm	12



ROUND SHOVEL WITH HANDLE

· beech handle with knuckle

MOQ
3

No.	dimensions	shaft length	
61088	26 x 28 cm	130 cm	3



ROUND SHOVEL

No.	dimensions	
61020	26 x 28 cm	12



SHOVEL WITH HANDLE

· hammer paint
· beech handle with knuckle

MOQ
3

No.	dimensions	shaft length	
61051	24 x 29 cm	130 cm	3



SHOVEL

· hammer paint

No.	dimensions	
61001	24 x 29 cm	12





SHOVEL

No.	dimensions	
61022	24 x 29 cm	12



SHOVEL WITH HANDLE

• beech handle with knuckle

MOQ
3

No.	dimensions	shaft length	
61090	24 x 29 cm	130 cm	3
61053	24 x 29 cm	130 cm "T" handle	3



SHOVEL

No.	dimensions	
61058	25 x 27 cm	12



SHOVEL WITH HANDLE

• beech handle with knuckle

MOQ
3

No.	dimensions	shaft length	
61059	25 x 27 cm	130 cm	3



NARROW SHOVEL

• hammer paint

No.	dimensions	
61002	19 x 27 cm	12



NARROW SHOVEL WITH HANDLE

• hammer paint
• beech handle with knuckle

MOQ
3

No.	dimensions	shaft length	
61052	19 x 27 cm	130 cm	3



NARROW SHOVEL

No.	dimensions	
61024	19 x 27 cm	12



NARROW SHOVEL WITH HANDLE

• beech handle with knuckle

MOQ
3

No.	dimensions	shaft length	
61054	19 x 27 cm	130 cm	3



PLASTIC SHOVEL

No.	dimensions	
61027	24 x 26 cm	12



SPADE POINTED WITH "T," HANDLE

· hammer paint

MOQ 3

No.	dimensions	shaft length	
61161	22 x 30 cm	90 cm	3



SPADE POINTED

· hammer paint

No.	dimensions	
61004	22 x 30 cm	12



SPADE POINTED WITH "T," HANDLE

MOQ 3

No.	dimensions	shaft length	
61097	19 x 30 cm	90 cm	3



SPADE POINTED

No.	dimensions	
61019	22 x 30 cm	12



DROP FORGED SPADE POINTED WITH "T," HANDLE

MOQ 3

No.	dimensions	shaft length	
61162	22 x 25 cm	90 cm	3
61223	handle	90 cm	1



DROP FORGED SPADE POINTED

No.	dimensions	
61013	22 x 25 cm	12



ROUND SPADE WITH "T," HANDLE

· hammer paint

MOQ 3

No.	dimensions	shaft length	
61163	21 x 30 cm	90 cm	3



SPADE ROUND

· hammer paint

No.	dimensions	
61003	21 x 30 cm	12





SPADE ROUND

No.	dimensions	
61018	21 x 30 cm	12



ROUND SPADE WITH "T" HANDLE

MOQ 3

No.	dimensions	shaft length	
61098	21 x 30 cm	90 cm	3



SPADE

No.	dimensions	
61014	14 x 37 cm	12



SPADE WITH "T" HANDLE

No.	dimensions	shaft length	
61164	14 x 37 cm	90 cm	MOQ 3
61203	handle	90 cm	1



FORK

No.	dimensions	
61009	20 x 32 cm	12



FORK WITH HANDLE

· beech handle with knuckle

MOQ 3

No.	dimensions	shaft length	
61165	20 x 32 cm	90 cm	3



DROP FORGED FORK

No.	dimensions	
61012	22 x 30 cm	12



DROP FORGED FORK WITH "T" HANDLE

No.	dimensions	shaft length	
61166	22 x 30 cm	90 cm	MOQ 3
61222	handle	90 cm	1



FORK

No.	dimensions	
61044	20 x 30 cm	12



FORK WITH "T" HANDLE

No.	dimensions	shaft length	
61028	20 x 30 cm	90 cm	MOQ 3
61209	handle	90 cm	1



DROP FORGET HOE WITH HANDLE

No.	dimensions	shaft length	MOQ	
61111	0,4 kg	120 cm	3	
61112	0,6 kg	120 cm	3	
61224	handle	120 cm	1	

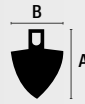

DROP FORGET HOE

No.	dimensions	A	B	MOQ	
61035	0,4 kg	180 mm	125 mm	1	
61036	0,6 kg	230 mm	160 mm	30	



DROP FORGET HOE WITH HANDLE

No.	dimensions	shaft length	MOQ	
61114	0,6 kg	120 cm	3	
61224	handle	120 cm	1	

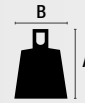

DROP FORGET HOE

No.	dimensions	A	B	MOQ	
61038	0,6 kg	165 mm	135 mm	20	



HOE WITH HANDLE

MOQ 3

No.	dimensions	shaft length	MOQ	
61290	75 mm	120 cm	3	
61291	125 mm	120 cm	3	
61292	175 mm	120 cm	3	

HOE

No.	dimensions	MOQ	
61067	75 mm	1	
61068	125 mm	1	
61069	175 mm	1	



HOE WITH HANDLE

MOQ 3

No.	dimensions	shaft length	MOQ	
61293	140 mm	120 cm	3	

HOE

No.	dimensions	MOQ	
61070	140 mm	40	



PICKAXE WITH HANDLE

MOQ 3

No.	dimensions	shaft length	MOQ	
61121	1,5 kg	95 cm	3	
61042	2,5 kg	95 cm	3	

PICKAXE

No.	dimensions	MOQ	
61120	1,5 kg	6	
61040	2,5 kg	6	



FESTA

SNOW SHOVEL



No.	dimensions	
60006	46 x 34 cm	12
60206	46 x 34 cm, assembled	1

FESTA

SNOW SHOVEL



No.	dimensions	
60008	50 x 34 cm	12
60208	50 x 34 cm, assembled	1

SNOW SHOVEL



MADE IN EU

No.	dimensions	
60001	48 x 40 cm	10
60201	48 x 40 cm, assembled	1

SNOW SHOVEL



ALU

No.	dimensions	
60012	50 x 38 cm	12
60212	50 x 38 cm, assembled	1



ICE SCRAPER

No.	dimensions		MOQ
60022	20 cm	3	3

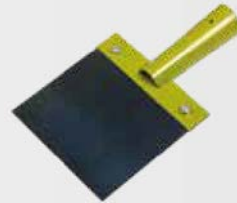

ICE SCRAPER

No.	dimensions	
60018	15 cm	20
60019	20 cm	24
60020	30 cm	20
61201	handle 130 cm	10



ROAD SALT

No.	dimensions	
43300	10 kg	1
43301	25 kg	1



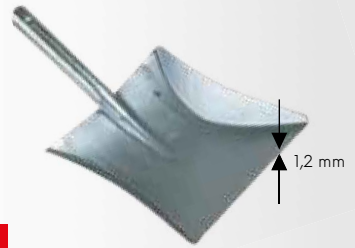

FESTA

STEEL SHOVEL - THICK

No.	dimensions	
52176	22 x 23 cm	24

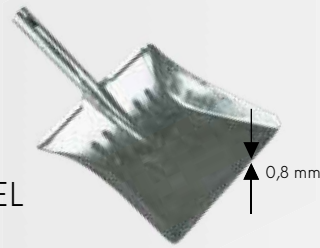

STEEL SHOVEL

Zn

No.	dimensions	
52175	22 x 23 cm	50



BRUSH WITH SHOVEL

MADE IN EU

No.	dimensions	
52168		26



BRUSH WITH SHOVEL

MADE IN EU

No.	dimensions	
52173		26



STEEL BRUSH WITH HANDLE

No.	shaft length	
52198	140 cm	1



BRUSH

MADE IN EU

No.	dimensions	
52119	29 cm	24



BRUSH WITH HANDLE

MADE IN EU

MOQ 3

No.	dimensions	
52197	30 cm 120 cm wooden	3



BRUSH

MADE IN EU

No.	dimensions	
52108	30 cm thread	25
61172	handle 20 cm thread	1



BRUSH WITH HANDLE

No.	dimensions	
52135	145 cm 5x stitched	1



system click ON - OFF

FESTA

BRUSH

No.	dimensions	
45323	37 cm	16





BRUSH

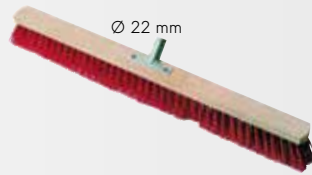

No.	dimensions		
52101	30 cm		10
52102	40 cm		10
52103	50 cm		10
52104	60 cm		10
52105	80 cm		10

BRUSH WITH HANDLE

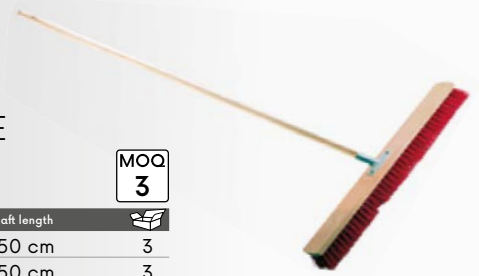

No.	dimensions	shaft length	
52190	30 cm	150 cm	3
52191	40 cm	150 cm	3
52192	50 cm	150 cm	3
52193	60 cm	150 cm	3
52194	80 cm	150 cm	3

BRUSH



No.	dimensions		
52160	40 cm		10
52161	50 cm		10
52162	60 cm		10
52163	70 cm		10
52164	80 cm		10

BRUSH WITH HANDLE



No.	dimensions	shaft length	
52185	40 cm	150 cm	3
52186	50 cm	150 cm	3
52187	60 cm	150 cm	3
52188	70 cm	150 cm	3
52189	80 cm	150 cm	3

BRUSH



No.	dimensions		
52114	28 cm	thread	1

BRUSH WITH HANDLE



No.	dimensions	shaft length	
52116	28 cm	with handle 130 cm	3

BRUSH



No.	dimensions		
52113	30 cm	thread	26
52115	30 cm	without thread	26

BRUSH WITH HANDLE



No.	dimensions		
52195	30 cm	150 cm woody	3
52196	30 cm	130 cm ALU	3

MASON STAFF - RUBBER

No.	dimensions		
15886	450 mm	handle Ø 23 mm	48
15887	600 mm	handle Ø 23 mm	48
15888	750 mm	handle Ø 23 mm	32



BRUSH WITH HANDLE



No.	dimensions		
52109	25 cm	120 cm woody	12

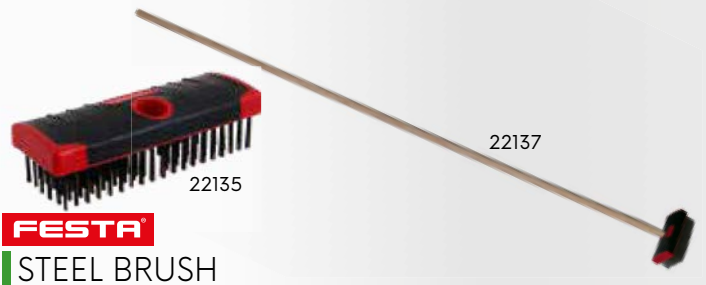

FESTA

STEEL BRUSH

No.	dimensions		
22135	6 x 19 cm	without handle	8
22137	6 x 19 cm	with handle 140 cm	MOQ 3



FESTA

NYLON BRUSH

No.	dimensions		
22136	6 x 19 cm	without handle	8
22138	6 x 19 cm	with handle 140 cm	MOQ 3



CLEANING MOP

No.	dimensions	
52110	30 cm	16



SPARE MOP

No.	dimensions	
52111	30 cm	1



FESTA

HANDLE

ALU

No.	dimensions	
45330	161 cm	24
45331	100 cm	24

system click
ON - OFF



BRUSH HANDLE

ALU MADE IN EU

No.	dimensions	
52126	130 cm, thread	1

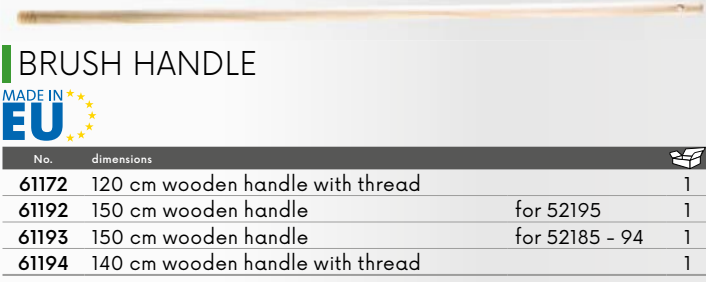

BRUSH HANDLE

MADE IN EU

No.	dimensions	
61172	120 cm wooden handle with thread	1
61192	150 cm wooden handle for 52195	1
61193	150 cm wooden handle for 52185 - 94	1
61194	140 cm wooden handle with thread	1



BRUSH HANDLE

MADE IN EU

No.	dimensions		No.	dimensions	
61171	1,2 m	1	61175	1,6 m	1
61173	1,4 m	1	61176	1,7 m	1
61174	1,5 m	1	61177	1,8 m	1



HANDLE FOR FORK AND SHOVEL



No.	dimensions	
61200	130 cm	10



HANDLE FOR SHOVEL



No.	dimensions	
61201	130 cm, equal	10

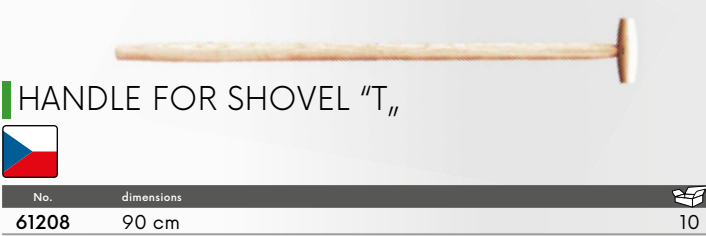

HANDLE FOR SHOVEL "T"



No.	dimensions	
61208	90 cm	10



HANDLE FOR SHOVEL "T"



No.	dimensions	
61202	130 cm, equal	10



HANDLE FOR MASON DIPPER



No.	dimensions	
61215	160 cm	10



HANDLE FOR PICKAXE



No.	dimensions	
61204	95 cm, narrow (for 61120)	10
61205	95 cm	10



HANDLE FOR PLASTIC RAKE



No.	dimensions	
61195	120 cm	10



HANDLE FOR RAKE



No.	dimensions	suitable for	
61250	160 cm	45051, 61048	20
61251	160 cm	45052	20
61252	160 cm	45320	20
61253	160 cm	45053	20
61254	160 cm	45054	20
61255	160 cm	45070	20
61256	160 cm	45055	20



HANDLE FOR SPADE



No.	dimensions	
61207	100 cm	10



HANDLE FOR HOE



No.	dimensions	
61219	120 cm	10

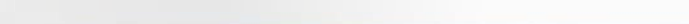

HANDLE FOR STEEL RAKE



No.	dimensions	
61183	150 cm	10
61184	160 cm	10
61189	170 cm	10
61190	180 cm	10



PLASTIC HANDLE "Y"

No.	dimensions	
61230		10



No.	
61005	15
61006	15
61050	15
61051	15
61052	15
61079	1
61097	15
61098	15

61077



• illustration photo

STAND FOR SHOVEL AND SPADE

No.	dimensions	
61077	stand with shovels, spades	1
61079	stand with pallet	1

HOLDER FOR GARDENING TOOLS

5x

No.	dimensions	
51184	12	

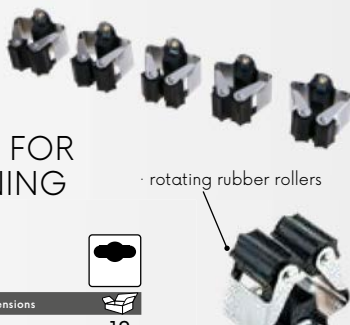

rotating rubber rollers



HOLDER FOR GARDENING TOOLS

No.	dimensions	
51185	45 cm 15	



• illustration photo



INSECT SCREENS

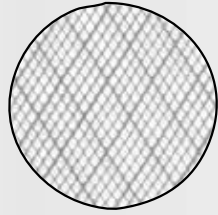

No.	dimensions		
40100	1 x 25 m - PE white		1
40120	1,2 x 25 m - PE white		1

INSECT SCREENS

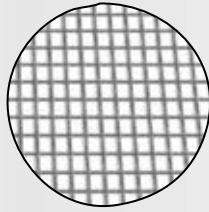

ALU **Zn**

No.	dimensions		
42101	1 x 30 m - ALUMINIUM		2
42103	1 x 30 m - galvanized wire		2

INSECT SCREENS

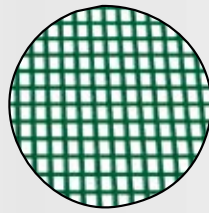

No.	dimensions		
42102	1x30m - green coated steel wire		2

FIBERGLASS INSECT SCREENS

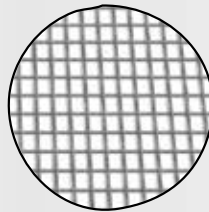

No.	dimensions			
41083	0,8 x 30 m	white	6	
41103	1 x 30 m	white	6	
41123	1,2 x 30 m	white	6	
41153	1,5 x 30 m	white	6	

No.	dimensions			
41082	0,8 x 30 m	white-grey	6	
41102	1 x 30 m	white-grey	6	
41122	1,2 x 30 m	white-grey	6	
41152	1,5 x 30 m	white-grey	6	

No.	dimensions			
41050	0,5 x 30 m	grey	6	
41080	0,8 x 30 m	grey	6	
41100	1 x 30 m	grey	6	
41120	1,2 x 30 m	grey	6	
41150	1,5 x 30 m	grey	6	

No.	dimensions			
41081	0,8 x 30 m	black	6	
41101	1 x 30 m	black	6	
41121	1,2 x 30 m	black	6	
41151	1,5 x 30 m	black	6	





WINDOW NET
WHITE



No.	dimensions		
40050	150 x 130 cm	5,6 m	10
40052	150 x 180 cm	6,6 m	10
40054	150 x 90 cm	4,8 m	10
40056	220 x 75 cm 2 pcs	5,8 m	10



WINDOW NET
GREY



No.	dimensions		
40051	150 x 130 cm	5,6 m	10
40053	150 x 180 cm	6,6 m	10
40055	150 x 90 cm	4,8 m	10



WINDOW NET
BLACK



No.	dimensions		
40057	150 x 130 cm	5,6 m	10
40058	150 x 180 cm	6,6 m	10
40059	150 x 90 cm	4,8 m	10



BURBAND
SELF ADHESIVE
FOR WINDOW NET

No.	dimensions	
40060	9 mm 7 m	1

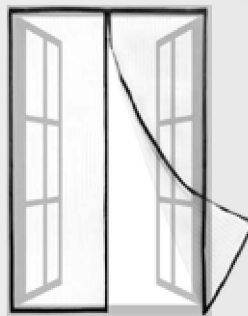

DOOR CURTAIN
AGAINST INSECTS
MAGNETIC – ANTHRACITE



No.	dimensions	
40077	100 x 220 cm	1



CURTAIN
AGAINST INSECT

· variable size 60 - 120 cm

No.	dimensions		
40075	4 x 35 x 220 cm	white	20
40076	4 x 35 x 220 cm	black	20

FENCING HEX

· galvanized before entanglement

Zn



No.	dimensions	
42150	13 0,7 x 1000 mm - 50 m	1
42151	16 0,7 x 1000 mm - 50 m	1
42152	20 0,7 x 1000 mm - 50 m	1
42153	25 0,8 x 1000 mm - 50 m	1

FENCING HEX

Zn



No.	dimensions	
42155	13 0,7 x 1000 mm - 50 m	1
42156	16 0,7 x 1000 mm - 50 m	1
42157	20 0,7 x 1000 mm - 50 m	1
42158	25 0,8 x 1000 mm - 50 m	1

FENCING
RECTANGULAR

Zn



No.	dimensions	
42160	13 1 x 1000 mm - 25 m	1
42161	16 1 x 1000 mm - 25 m	1
42162	20 1 x 1000 mm - 25 m	1
42163	25 1 x 1000 mm - 25 m	1

FENCING RECTANGULAR
PVC COATED



No.	size	Ø of wire	height	length	
42175	15 x 9 mm	2 mm	40 cm	25 m	1
42176	15 x 9 mm	2 mm	65 cm	25 m	1
42177	15 x 9 mm	2 mm	90 cm	25 m	1
42178	15 x 9 mm	2 mm	120 cm	25 m	1
42179	15 x 9 mm	2 mm	25 cm	25 m	1



GARDEN FENC

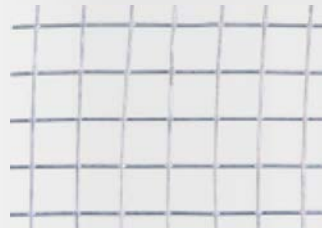

140 g/m² UV STABLE

No.	dimensions	
42185	6 0,65 x 1000 mm - 25 m	1
42170	10 0,8 x 100 mm - 25 m	1
42171	13 0,8 x 1000 mm - 25 m	1
42172	16 1,2 x 1000 mm - 25 m	1
42173	19 1,4 x 1000 mm - 25 m	1

GARDEN FENC PVC COATED



No.	dimensions	
42180	13 1,2 x 1000 mm - 25 m	1
42181	16 1,2 x 1000 mm - 25 m	1
42182	25 2,3 x 1000 mm - 25 m	1

NET AGAINST BIRDS



MADE IN EU

No.	dimensions	
45570	2 x 5 m 18 x 18 mm	45
45571	2 x 10 m 18 x 18 mm	28
45572	4 x 5 m 18 x 18 mm	24
45573	4 x 10 m 18 x 18 mm	15

SAFETY MESH FENCING

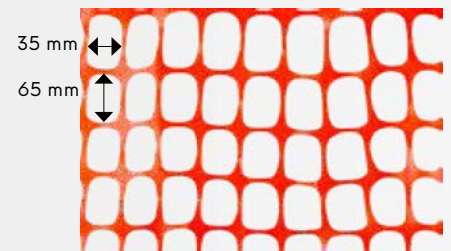

140 g/m² UV STABLE

No.	dimensions	
42190	1,2 x 50 m HDPE 140g/m ²	1

FENCING RABIC

Zn



No.	dimensions	
42312	1 m 50 bm, 16 x 16 mm	1

FINCING AGAINST BROWSING

self-locking

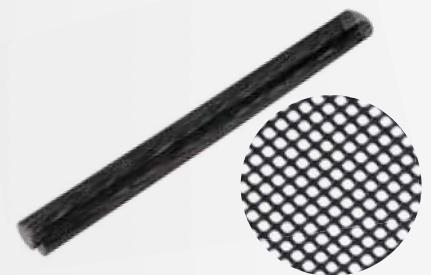

3x MADE IN EU

No.	dimensions	
45580	Ø 11 x 80 cm	1



WIRE

Zn

No.	Ø of wire	length of wire	
42203	0,6 mm	30 m	50

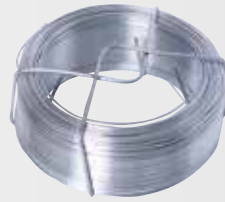

WIRE

Zn

No.	Ø of wire	length of wire	
42207	0,8 mm	50 m	40
42208	0,8 mm	100 m	20
42209	0,9 mm	100 m	20
42240	1,0 mm	50 m	40
42210	1,0 mm	100 m	20
42211	1,2 mm	50 m	40
42212	1,2 mm	100 m	20
42213	1,4 mm	30 m	40
42214	1,4 mm	50 m	20
42217	1,8 mm	30 m	40
42218	1,8 mm	50 m	20



WIRE

Zn

No.	Ø of wire	length of wire	
42219	2,0 mm	26 m	20
42220	2,0 mm	52 m	20
42221	2,0 mm	78 m	20
42228	3,15 mm	26 m	10
42229	3,15 mm	52 m	10
42230	3,15 mm	78 m	10



WIRE

No.	Ø of wire	length of wire	coating	
42201	0,6 mm	30 m	PVC	50
42202	0,9 mm	30 m	PVC	50



WIRE, GREEN PVC COATED

No.	Ø of wire	length of wire	
42244	1,4 mm	50 m	20
42248	1,8 mm	50 m	20
42249	2,0 mm	50 m	20



WIRE, GREEN PVC COATED

No.	Ø of wire	length of wire	
42251	2,6 mm	26 m	20
42252	2,6 mm	52 m	20
42253	2,6 mm	78 m	20
42255	3,4 mm	26 m	10
42256	3,4 mm	52 m	10
42257	3,4 mm	78 m	10



BARBED WIRE

Zn

No.	Ø of wire	length of wire	
42260	1,7 mm	50 m	1
42261	1,7 mm	100 m	1



CLAMP OF THE BINDING WIRE

No.	dimensions	
50040	INOX stainless edge, green	MOQ 50
50041	INOX stainless edge, black	MOQ 50



CLAMP OF THE BINDING WIRE

No.	dimensions	
50042	10x	10



TIGHTENING EQUIPMENT

No.	dimensions	
50035	2 t	6
50036	4 t	4



WIRE STRAINER SMALL

Zn

No.	dimensions	
50030	small, Zn coated	50
50032	small PVC coated	50



WIRE STRAINER BIG

Zn

No.	dimensions	
50031	Zn coated	50
50033	PVC coated	50



WIRE STRAINER SMALL LT

Zn

No.	dimensions	
50037	Zn coated	50
50038	PVC coated	50

POLE ANCHORE

Zn

No.	dimensions	thickness	
55436	70 x 75 mm 110 mm	4 mm	10
55437	80 x 90 mm 130 mm	4 mm	10



POLE ANCHORE

Zn

No.	dimensions	thickness	
55429	70 x 60 mm 100 mm	4 mm	10
55433	81 x 60 mm 100 mm	4 mm	10
55430	91 x 60 mm 100 mm	4 mm	10
55431	101 x 60 mm 100 mm	4 mm	10
55432	121 x 60 mm 100 mm	4 mm	10



ADJUSTABLE POLE ANCHOR

Zn

No.	specification	thickness	
55465	80 - 160 x 70 mm 100 mm	4 mm	1

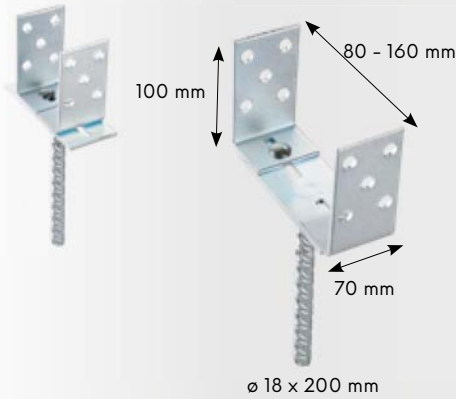

POLE ANCHORE

Zn

No.	Ø of anchor	length of anchor	material thickness	
55420	71 x 71 mm	150 mm	2 mm	1
55425	81 x 81 mm	150 mm	2 mm	1
55421	91 x 91 mm	150 mm	2 mm	1
55422	101 x 101 mm	150 mm	2 mm	1
55423	121 x 121 mm	150 mm	2 mm	1
55424	151 x 151 mm	150 mm	2 mm	1



POLE ANCHORE WITH ADJUSTABLE SCREW

Zn

No.	Ø of anchor	height of anchor	screw	
55460	80 x 80 mm	150 mm	M16	10
55461	100 x 100 mm	150 mm	M16	10
55462	150 x 150 mm	150 mm	M24	10



SOIL DRILL

No.	Ø	A	B	
61299	110 mm	270 mm	1200 mm	1
61300	140 mm	270 mm	1200 mm	1
61301	170 mm	270 mm	1200 mm	1
61302	200 mm	270 mm	1200 mm	1



POLE ANCHORE

Zn

No.	Ø of anchor	length of anchor	material thickness	
55400	71 x 71 mm	750 mm	2 mm	1
55401	91 x 91 mm	750 mm	2 mm	1
55406	81 x 81 mm	750 mm	2 mm	1
55402	91 x 91 mm	900 mm	2 mm	1
55403	101 x 101 mm	900 mm	2 mm	1
55404	121 x 121 mm	900 mm	2 mm	1
55405	151 x 151 mm	900 mm	2 mm	1



ANCHORAGE SCREW "U"

Zn

No.	Ø of anchor	length of anchor	material thickness	
55455	71 x 60 mm	100 mm	4 mm	1
55452	81 x 60 mm	100 mm	4 mm	1
55456	90 x 60 mm	100 mm	4 mm	1
55453	101 x 60 mm	100 mm	4 mm	1
55457	110 x 60 mm	100 mm	4 mm	1
55454	121 x 60 mm	100 mm	4 mm	1

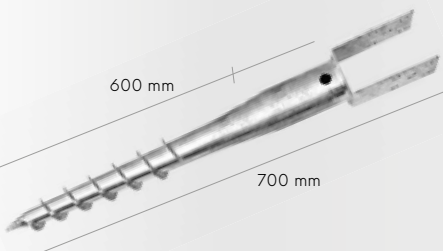

UNIVERSAL ANCHORAGE SCREW SET

reduction

- Ø 24 mm
- Ø 35 mm
- Ø 40 mm
- Ø 48 mm
- Ø 55 mm

Zn 6x

No.	Ø of anchor	length of anchor	dimensions	
55450	60 mm	550 mm	1 ks + 5x reduction	8



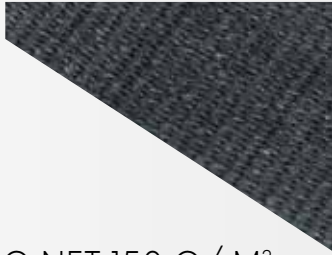

SHADING NET 150 G/ M²
ANTHRACITE

· shade 85%



No.	dimensions	
45496	1 x 10 m	1
45497	1,5 x 10 m	1
45498	1,8 x 10 m	1
45499	2 x 10 m	1

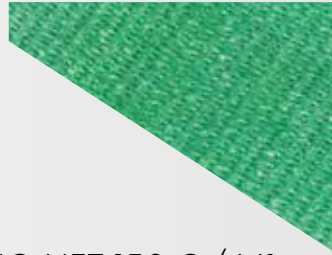

SHADING NET 150 G/ M²

· shade 85%



No.	dimensions	
45460	1 x 10 m	1
45461	1,5 x 10 m	1
45463	1,8 x 10 m	1
45462	2 x 10 m	1



SHADING NET 220 G/ M²

· shade 95%



No.	dimensions	
45465	1 x 10 m	1
45466	1,5 x 10 m	1
45467	2 x 10 m	1

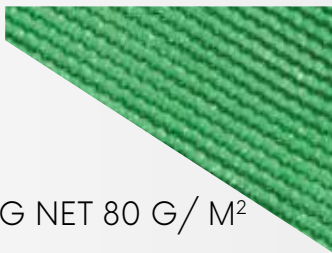

SHADING NET 80 G/ M²



No.	dimensions	
45450	1 x 10 m	1
45451	1,5 x 10 m	1
45453	1,8 x 10 m	1
45452	2 x 10 m	1

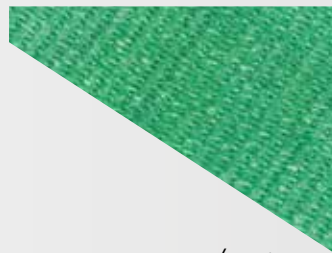

SHADING NET 150 G/ M²

· shade 85%

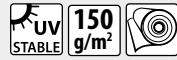

No.	dimensions	
45480	1,5 x 50 m	1

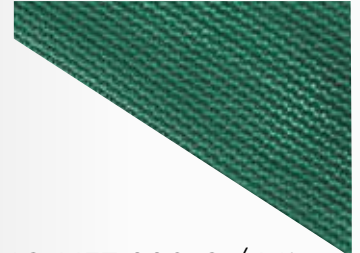

SHADING NET 220 G/ M²

· shade 95%

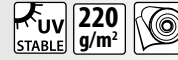

No.	dimensions	
45485	1,5 x 50 m	1



BINDING TAPES

· EN 50146
· nylon



No.	specification	
23875	120 mm 4,8 mm	1



No.	dimensions	
45470		1





TOOL GRILL SET

INOX 18x

No.	dimensions
43077	



6



TOOL GRILL SET

INOX 3x

No.	dimensions
43071	380 mm



16



GRILL PLIERS

INOX

No.	dimensions
43072	360 mm



25



GRILL PLATE

4x

No.	dimensions
43050	300 x 200 mm

50



GRILL GRID

No.	dimensions
43084	330 x 290 mm

50

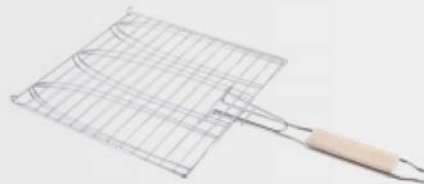

FISH FIREGRATE

No.	dimensions
43082	280 x 276 mm

50

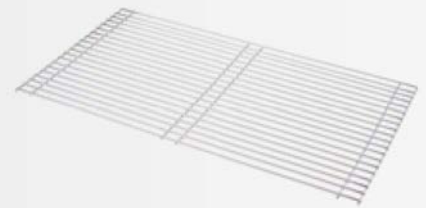

GRILL

No.	dimensions
43058	58 x 30 mm
43060	60 x 40 mm
43068	68 x 40 mm

20

20

16



FISH FIREGRATE

No.	dimensions
43083	360 x 130 mm

12



SKEWERS

4x

No.	dimensions
43086	Ø 3 x 380 mm

80



GRILL FORK

grill fork with hygienic atest

No.	dimensions
43097	100 cm

100

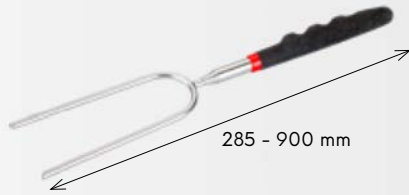

GRILL FORK - TELESCOPIC



No.	specifications	
43094		1



AIR COMPRESSOR



No.	dimensions	
43087		1



BARBEQUE BRUSH 2 IN 1

No.	dimensions	
43098	30 cm	10



BRUSH 3 IN 1

No.	dimensions	
43099		40



GRILL MOTOR 230V



No.	dimensions	
43090		24



GRILL MOTOR, BATTERY



No.	dimensions	
43089		48



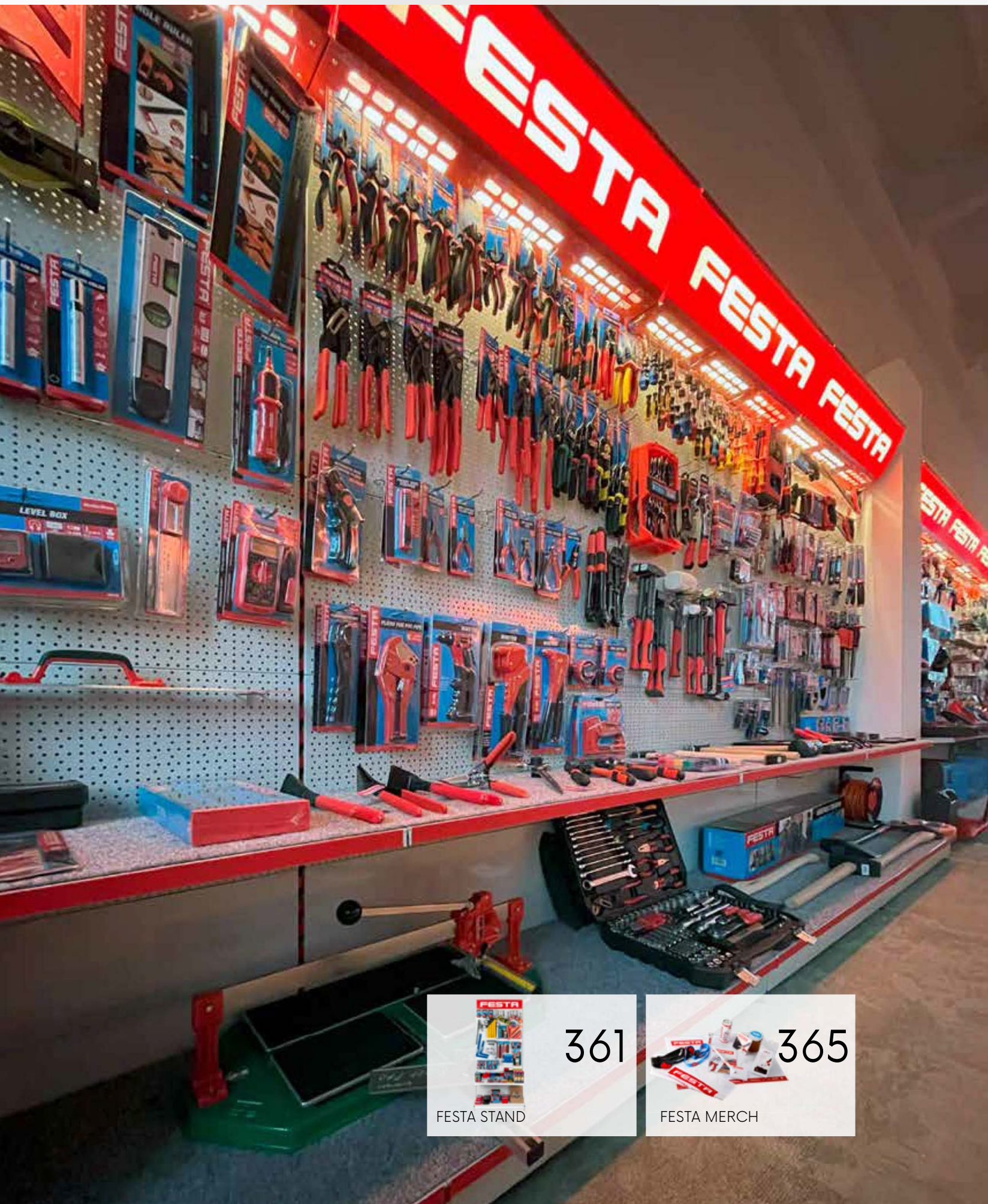

361

FESTA STAND



365

FESTA MERCH



 FESTA STAND WITH ITEMS

FESTA
LIGHT BOX FOR FESTA STAND 81011

No.	specification	
81195	FESTA POWER TOOLS	1
81196	FESTA	1
81197	FESTA INDUSTRY	1



FESTA STAND + ACCESORIES



No.	specification	
81011	stand FESTA 220 x 100 cm	1
81011A	stand 81011 + sticker AQUATIC	1
81011F	stand 81011 + sticker FESTA CZ	1
81011G	stand 81011 + sticker FESTA GB	1
81011H	stand 81011 + sticker FESTA SK	1
81011R	stand 81011 + sticker ROSA	1
81012	shelf for the stand FESTA 100 x 40 cm	8
81013	hook 10 cm	10
81014	hook 16 cm	10
81015	hook 20 cm	10
81035	hook with plastic price tag 20 cm	10
81016	hook 30 cm	10
81036	hook with plastic price tag 30 cm	10
81022	wire basket - big, 50 cm	1
81023	wire basket - small, 40 cm	1
81024	partition - big, 50 cm	1
81025	partition - small, 40 cm	1

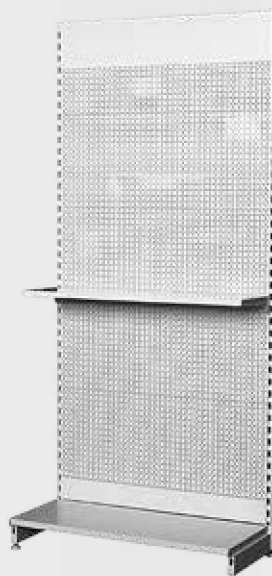



TRADE BRACKET

· compatible with FESTA stand

No.	specification	
81150	1000 × 50 × 135 mm	1
81151	1000 × 150 × 135 mm	1
81152	1000 × 350 × 135 mm	1

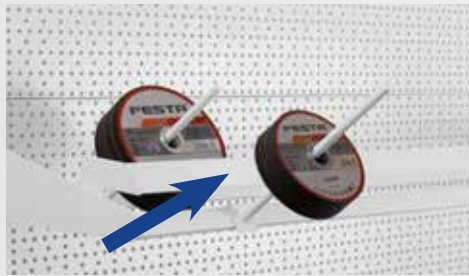

PRICE HOLDER

· compatible with FESTA stand

No.	specification	
81155	1000 × 80 × 100 mm	1

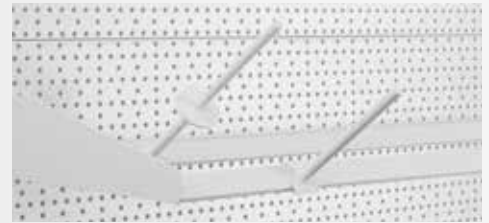

HOOK FOR CUTTING DISCS

· compatible with FESTA stand

No.	specification	
81186	150 mm	1
81185	250 mm	1



FRAME FOR CUTTING DISCS

· compatible with FESTA stand

No.	specification	
81170	1000 × 450 × 85 mm	1



SAWS HOLDER

· compatible with FESTA stand

No.	specification	
81190		1



HOOK FOR CORDLESS TOOLS

· compatible with FESTA stand

No.	specification	
81189		1



SHELF FOR DISCS

· compatible with FESTA stand

No.	specification	
81191	220 × 220 × 200 mm	1

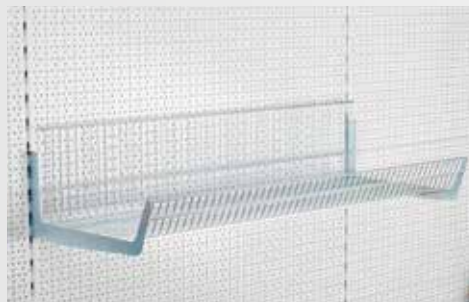

WIRE BASKET

· compatible with FESTA stand

No.	specification	
81160	1000 × 470 × 180 mm	1



DIVIDER

· compatible with FESTA stand

No.	specification	
81165	470 × 180 mm	1



HAMMERS AND MALLETS HOLDER

Zn

· compatible with FESTA stand

No.	specification	
81188	max 2 kg	1



HOOK FOR HORIZONTAL BAR

· compatible with FESTA stand

No.	specification	
81175	120 mm	1
81178	180 mm	1

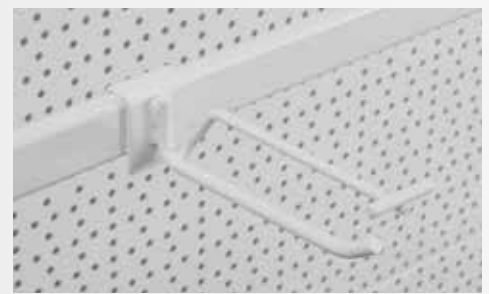

HOOK FOR HORIZONTAL BAR

· compatible with FESTA stand

No.	specification	
81180	120 mm	1



No.	specification	
81200	Handstand 40/2400 mm anchored	1
81201	Handstand 80/1108 mm	1
81202	Handstand 80/1208 mm	1
81203	Handstand 80/1408 mm	1
81204	Handstand 80/1608 mm	1
81205	Handstand 80/1808 mm	1
81206	Handstand 80/2000 mm	1
81207	Handstand 80/2108 mm	1
81208	Handstand 80/2208 mm	1
81209	Handstand 80/2308 mm	1
81210	Handstand 80/2408 mm	1
81211	Handstand 80/2600 mm	1
81212	Handstand 60/1000 mm	1
81213	Handstand 60/1208 mm	1
81214	Handstand 60/1408 mm	1
81215	Handstand 60/1608 mm	1
81216	Handstand 60/1808 mm	1
81217	Handstand 60/2108 mm	1
81218	Handstand 60/2208 mm	1
81225	Handstand 30/2108 mm front	1
81486	Handstand 60/2000 mm	1
81219	Adapter of handstand 80x30/100mm	1
81220	Adapter of handstand 80x30/400 mm	1
81221	Adapter of handstand 80x30/600 mm	1
81222	Adapter of handstand 60x30/400 mm	1
81223	Corner handstand 90° 2100mm	1
81224	Corner handstand 90° 2200mm	1
81226	Support 80	1
81227	Support 60	1
81228	Clutch gondolas with a shelf 80	1
81229	Anchor bar	1
81230	Anchor hook	1
81231	Anchoring light	1
81232	Anchoring top	1
81233	Filling 400	1
81234	Filling 500	1
81235	Filling 600	1
81236	Filling 700	1
81237	Filling 800	1
81238	Console low 200	1
81239	Console low 300	1
81240	Console low 400	1
81241	Console low 500	1
81242	Console high 400	1
81243	Console high 500	1
81244	Console high 600	1
81245	Console high 700	1
81246	Console low 300 double	1
81247	Console low 400 double	1
81248	Console low 300 double	1
81251	Console RR 80	1
81249	Console high double 500	1
81250	Beam showcase 400/2000	1
81252	Hyphen trough shelves	1
81253	Hyphen low 300	1
81254	Hyphen low 400	1
81255	Hyphen low 500	1
81256	Hyphen low 300 glass	1
81257	Hyphen low 400 glass	1
81258	Hyphen low 500 glass	1
81259	Hyphen high 300 glass	1
81262	Hyphen high 300 plexi	1
81263	Hyphen high 400 plexi	1
81264	Hyphen high 500 plexi	1
81260	Hyphen high 400 glass	1
81261	Hyphen high 500 glass	1
81265	Side of showcase 400/2000	1
81266	Sidewall roofing RR 80	1
81267	Sidewall tray 500mm	1
81268	Sidewall showcase 500	1
81269	Beam showcase 500	1
81271	Sidewall shelves low 300 plastic	1
81272	Sidewall shelves low 400 plastic	1
81273	Sidewall shelves low 500 plastic	1
81274	Sidewall high glass 300/250	1
81275	Safety fuse	1
81276	Sidewall high glass 500/250	1
81277	Sidewall shelves high 400	1
81278	Sidewall shelves high 500	1
81270	Beam roofing RR 80	1
81279	Beam roofing	1
81280	Sidewall roofing left	1
81281	Sidewall roofing right	1
81282	Suspension arm	1
81284	Double shoulder 400/10	1
81285	Double shoulder 300/8	1
81286	Simple shoulder 350	1
81287	Simple shoulder 500	1
81288	Simple shoulder 250	1
81289	Double hinge 100	1
81290	Double hinge 200	1
81291	Double hinge 300	1
81292	Hinge 130 V	1

No.	specification	
81293	Simple hinge 100	1
81294	Simple hinge 200	1
81295	Simple hinge 300	1
81296	Hook with horizontal bar 200	1
81297	Hook with horizontal bar 300	1
81298	Lock showcase	1
81299	Hyphen wire 360mm high	1
81300	Hyphen wire 460 mm high	1
81301	Hyphen wire 560 mm high	1
81302	Hyphen wire 560 mm nízke	1
81303	Bracket 300 double L	1
81304	Bracket 300 double P	1
81305	Bracket 400 double L	1
81306	Bracket 400 double P	1
81307	Bracket 500 double L	1
81308	Bracket 500 double P	1
81309	Shelf semicircle 300	1
81310	Shelf semicircle 400	1
81311	Shelf semicircle 500	1
81312	Sokl pülkruhu 500	1
81313	Forehead base semicircle 500	1
81314	Bracket 300 price tag semicircle	1
81315	Bracket 400 price tag semicircle	1
81316	Bracket 500 price tag semicircle	1
81317	Shelf semicircle 600	1
81318	Plinth semicircle 600	1
81319	Forehead base semicircle 600	1
81320	Price tag P 7,5x5 cm	1
81321	Price tag P 2,6x3,2 cm	1
81322	Price tag P 5,0x4,0 cm	1
81323	Perforated shelf 500/1000	1
81324	Connector upright 80, Module 1	1
81325	Rear panel 10x100cm	1
81326	Rear panel 20x100cm	1
81327	Rear panel 40x100cm	1
81328	Perforated rear panel 20x100 cm EUR	1
81329	Perforated rear panel 40x100 cm EUR	1
81330	Cover gondolas 8x100cm	1
81331	Cover gondolas 6x100cm	1
81332	Beam hinges 100cm	1
81333	Glass shelf 985/300 vitrine	1
81334	Glass shelf 985/400 vitrine	1
81335	Wooden shelf 47/98,5	1
81336	Wire shelf 1000/500	1
81337	Troughed shelf 1000x500	1
81338	Shelf 200/1000	1
81339	Shelf 300/1000	1
81340	Shelf 400/1000	1
81341	Shelf 500/1000	1
81342	Shelf 400/1000 RAL7015	1
81343	Shelf 500/1000 RAL7015	1
81347	High frame showcases 1000/400	1
81348	Glass frame high showcases 1000/400	1
81349	Female insert shelf	1
81350	Suspended ceiling metal shelves 500/100	1
81352	Front support high glass 1000 mm	1
81353	Front support high plexi	1
81354	Front support low plastic 1000 mm	1
81355	Price bar, 1000mm	1
81356	Comb socket rack	1
81351	Comb for high dividers, 1000	1
81357	Comb, 1000 mm	1
81403	Comb for high dividers, 1250 mm	1
81420	Comb for high dividers, 625 mm	1
81358	Double-groove door showcases	1
81359	Price tag holder, 1000mm	1
81360	Door showcases 1000/2000	1
81361	Forehead roofing, 1000mm	1
81362	Tile roofing, 1000mm	1
81363	Tray door	1
81364	Sliding door showcases	1
81365	Mirror showcases	1
81366	Hinge frame, module 1	1
81367	Curtain rod	1
81370	Trash wire oblique	1
81371	Tour 1000mm full plate	1
81372	Skirting the counter SU 5 1000mm	1
81373	Counter glassed 1000mm	1
81374	Counter with stainless steel plate 1000mm	1
81375	Counter with full plate 600mm	1
81376	Shelf counter 600mm	1
81377	Counter glassed 600mm	1
81378	Shelf counter 1000mm	1
81379	Long shelf counter	1
81380	Segment counter high 90°	1
81381	Double-groove counter 1000mm, couple	1
81382	Sliding doors counter 1000mm, couple	1
81383	Drawer board	1
81384	Wire shelf RDE 1000/360mm	1
81385	Wire shelf RDE 1000/460mm	1
81386	Wire shelf RDE 1000/560mm	1
81387	Price bar RDE 1000 mm	1
81388	Rear panel 100/1250mm full	1

No.	specification	
81389	Rear panel 200/1250mm full	1
81390	Rear panel 400/1250mm full	1
81391	Rear panel 200/1250mm perforated	1
81393	Cover gondolas 80/1250mm	1
81392	Rear panel 400/1250mm perforated	1
81394	Cover gondolas 60/1250mm	1
81395	Beam hinges 1250mm	1
81396	Shelf 200/1250mm	1
81439	Beam hinges 1000 mm	1
81344	Shelf 300/1000 respecification rced	1
81345	Shelf 400/1000 respecification rced	1
81346	Shelf 500/1000 respecification rced	1
81397	Shelf 300/1250mm	1
81400	Shelf 300/1250mm, respecification rced	1
81401	Shelf 400/1250mm, respecification rced	1
81402	Shelf 500/1250mm, respecification rced	1
81398	Shelf 400/1250mm	1
81399	Shelf 500/1250mm	1
81404	Front fulcrum low 1250mm, white plastic	1
81405	Price bar, 1250mm	1
81406	Comb 1250mm	1
81407	Price tag holder, 1250mm	1
81408	Forehead roofing, 1250mm	1
81409	Tile roofing, 600x1250mm	1
81410	Rear panel 100/625 full	1
81411	Rear panel 200/625 full	1
81412	Rear panel 400/625 full	1
81413	Rear panel 400/625 perforated	1
81414	Cover gondolas 80/650	1
81415	Cover gondolas 60/650	1
81416	Beam hinges, module 3	1
81432	Beam hinges, 1330mm	1
81417	Shelf 300/625	1
81418	Shelf 400/625	1
81419	Shelf 500/625	1
81421	Front support low 625, white plastic	1
81422	Price bar 625mm	1
81423	Comb 625mm	1
81424	Price tag holder, 625mm	1
81425	Rear panel 100/1330 full	1
81457	Molded plastic abutment low 200	1
81426	Rear panel 200/1330 full	1
81427	Rear panel 400/1330 full	1
81428	Rear panel 200/1330 perforated S	1
81429	Rear panel 400/1330 perforated S	1
81430	Cover gondolas 80/1330	1
81431	Cover gondolas 60/1330	1
81433	Shelf 300/1330	1
81434	Shelf 400/1330	1
81435	Shelf 500/1330	1
81436	Price bar, 1330 mm	1
81437	Comb 1330 mm	1
81438	Price tag holder 1330 mm	1
81440	Wire shelf - basket	1
81441	Rear panel 100 fillet	1
81442	Rear panel 400 fillet	1
81443	Forehead plinth fillet 500/1000mm	1
81444	Forehead plinth fillet 600 mm	1
81445	Rear panel fillet 400mm perforated	1
81447	Shelf 300 fillet	1
81448	Shelf 400 fillet	1
81449	Shelf 500 fillet	1
81450	Shelf 600 fillet	1
81451	Price tag holder 300 fillet	1
81452	Price tag holder 400 fillet	1
81453	Price tag holder 500 fillet	1
81454	Price bar 300 fillet	1
81455	Price bar 400 fillet	1
81456	Price bar 500 fillet	1
81458	Wire shelf basket U 1000/400	1
81459	Wire shelf basket U 1000/500	1
81460	Corner forehead plinth 90°	1
81461	Rear corner panel 100, stand 60	1
81462	Rear corner panel 200, stand 60	1
81463	Rear corner panel 400, stand 80	1
81466	Rear corner panel 100, stand 80	1
81467	Rear corner panel 400, stand 60	1
81468	Police corner 90° 400mm	1
81469	Police corner 90° 500mm	1
81470	Price tag holder corner 90° 400mm	1
81471	Price tag holder corner 90° 500mm	1
81472	Price bar fillet 90° 400mm	1
81473	Price bar fillet 90° 500mm	1



BRACKET WHITE

MOQ
2

No.	specification	
81100	100 x 75 mm	24
81101	125 x 100 mm	24
81102	150 x 125 mm	24
81103	200 x 150 mm	24
81104	250 x 200 mm	24
81105	300 x 250 mm	24
81106	350 x 300 mm	24



HOOK BRACKET SINGLE

No.	specification	
81053	50 cm	10
81054	80 cm	10
81057	200 cm	10



HOOK BRACKET SINGLE

No.	specification	
81070	10 cm	10
81071	15 cm	10
81077	50 cm	10



PAPER STAND FOR LEVELING SYSTEMS



No.	specification	
37179	60 x 40 x 175 cm - ENG	1



PAPER STAND FESTA



No.	specification	
81602	60 x 40 x 175 cm - ENG	1

PAPER STAND FESTA POWER TOOLS



No.	specification	
81603	60 x 40 x 175 cm	1

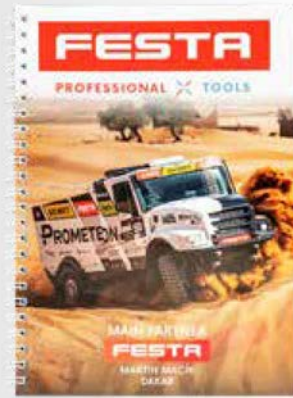

FESTA
FESTA ADVERTISING BLOCK

No.	specification
M90400	



FESTA
FESTA RED ADVERTISING T-SHIRT

No.	specification	
M90203	M	1
M90204	L	1
M90205	XL	1
M90206	XXL	1
M90207	XXXL	1



FESTA
FESTA ADVERTISING PEN

No.	specification
M90403	



FESTA
FESTA ADVERTISING USB CABLE

No.	specification
M90519	



FESTA
FESTA ADVERTISING SOCKS

No.	specification	
M90220	39-41	1
M90221	42-44	1
M90222	45-47	1



FESTA
FESTA ADVERTISING METER

No.	specification
11410	2 m x 16 mm



FESTA
FESTA ADVERTISING CAP

No.	specification	
M90210		1



FESTA
FESTA ADVERTISING FOLDING KNIFE

No.	specification
16209	



number of item	page	number of item	page	number of item	page	number of item	page	number of item	page	number of item	page
10002	96	11355	98	13249	121	13414	101	13509	99	14420	104
10003	96	11356	98	13250	121	13415	101	13510	99	14421	104
10005	96	11358	98	13251	121	13416	101	13511	99	14425	105
10008	96	11360	98	13252	121	13417	101	13512	99	14430	105
10025	96	11410	100	13253	121	13418	101	13513	99	14435	105
10033	96	11410	365	13254	121	13419	101	13514	99	14440	105
10035	96	11416	99	13255	121	13420	101	13515	99	14445	105
10043	96	11420	100	13256	121	13421	101	13516	99	14446	105
10045	96	11425	100	13257	121	13422	101	13517	99	14450	105
10048	96	11444	100	13258	121	13423	101	13518	99	14451	105
10110	96	11445	100	13259	121	13424	101	13519	99	14455	105
10120	96	12010	99	13260	120	13425	101	13520	99	14456	105
10130	96	12020	99	13261	117	13426	101	13521	99	14457	105
10330	96	12030	99	13262	117	13427	101	13522	99	14458	105
10332	96	12050	99	13263	117	13428	101	13523	99	14471	105
10334	96	12110	99	13264	116	13429	101	13524	99	14472	105
10336	96	12120	99	13265	116	13430	101	13525	99	14473	105
10430	97	12130	99	13266	116	13431	101	13526	99	14474	105
10450	97	12150	99	13267	117	13432	101	13527	99	14480	104
10490	97	12220	99	13268	116	13433	101	13528	99	14485	109
10996	97	12230	99	13269	116	13434	101	13529	99	14485	271
10998	97	12250	99	13270	116	13435	101	13530	99	14486	109
10999	97	12433	100	13271	116	13436	101	13531	99	14486	271
11002	99	12435	100	13272	116	13437	101	13532	99	14490	105
11003	99	13010	101	13273	116	13438	101	13533	99	14491	105
11005	99	13020	101	13274	116	13439	101	13534	99	14492	105
11006	99	13021	101	13275	116	13440	101	14001	102	14493	105
11007	99	13022	101	13276	117	13441	101	14002	102	14494	105
11008	99	13023	101	13277	120	13442	101	14003	102	15003	107
11082	99	13111	101	13278	116	13443	101	14004	102	15004	107
11083	99	13120	101	13279	117	13444	101	14006	102	15005	107
11085	99	13200	118	13280	117	13445	101	14007	102	15006	107
11102	98	13201	118	13281	102	13446	101	14008	102	15008	107
11103	98	13202	118	13282	102	13447	101	14009	102	15010	107
11105	98	13205	119	13284	117	13448	101	14010	103	15012	107
11106	98	13206	119	13285	102	13449	101	14011	103	15015	107
11107	98	13207	119	13288	117	13450	101	14012	103	15018	107
11110	98	13208	119	13290	217	13451	101	14013	102	15020	107
11200	99	13211	101	13293	217	13452	101	14015	103	15033	106
11201	99	13212	119	13294	217	13453	101	14017	103	15034	106
11202	99	13214	118	13295	120	13454	101	14019	103	15035	106
11204	99	13216	118	13296	120	13455	101	14025	105	15036	106
11205	99	13217	118	13350	121	13456	101	14030	103	15037	106
11206	99	13218	118	13351	121	13457	101	14035	102	15039	106
11207	99	13219	118	13352	121	13458	101	14040	102	15103	107
11208	99	13220	101	13353	121	13459	101	14045	102	15104	107
11209	99	13222	118	13354	121	13460	101	14060	103	15105	107
11210	99	13223	118	13355	121	13461	101	14070	103	15106	107
11220	98	13224	118	13360	121	13462	101	14075	103	15108	107
11221	98	13225	118	13361	121	13463	101	14077	103	15110	107
11226	98	13226	118	13362	121	13464	101	14080	102	15112	107
11239	98	13227	118	13363	121	13465	101	14090	104	15115	107
11259	98	13228	118	13364	121	13466	101	14091	104	15118	107
11260	98	13229	118	13365	121	13467	101	14220	105	15120	107
11311	100	13230	118	13399	101	13468	101	14225	105	15204	107
11312	100	13231	118	13400	101	13469	101	14230	105	15205	107
11313	100	13235	118	13401	101	13470	101	14235	105	15206	107
11314	100	13236	118	13402	101	13471	101	14240	105	15208	107
11323	98	13237	118	13403	101	13472	101	14250	105	15210	107
11325	98	13238	118	13404	101	13473	101	14350	105	15212	107
11327	98	13240	120	13405	101	13500	99	14360	105	15215	107
11333	98	13241	120	13406	101	13501	99	14370	105	15218	107
11335	98	13242	120	13407	101	13502	99	14380	105	15220	107
11337	98	13243	120	13408	101	13503	99	14399	105	15230	107
11338	98	13244	120	13409	101	13504	99	14410	105	15235	108
11343	98	13245	120	13410	101	13505	99	14411	105	15301	109
11345	98	13246	119	13411	101	13506	99	14415	104	15301	271
11347	98	13247	119	13412	101	13507	99	14417	104	15310	108
11353	98	13248	119	13413	101	13508	99	14418	104	15310	270

LIST OF ITEMS



number of item	page	number of item	page	number of item	page	number of item	page	number of item	page	number of item	page
15315	108	15810	109	16003	122	16075	130	16300	139	17037	137
15315	270	15810	271	16004	122	16077	130	16301	139	17038	177
15318	108	15812	109	16005	122	16078	130	16303	139	17039	176
15318	270	15812	271	16006	122	16081	130	16304	139	17040	174
15320	108	15815	109	16010	122	16082	129	16305	138	17041	174
15320	270	15815	271	16010	122	16083	131	16306	138	17042	174
15325	108	15818	109	16011	122	16084	131	16307	138	17043	174
15325	270	15818	271	16011	122	16085	126	16308	138	17044	174
15330	108	15820	109	16011	122	16086	126	16309	138	17045	174
15330	270	15820	271	16012	122	16087	127	16310	139	17046	177
15335	108	15825	109	16012	122	16090	125	16310	139	17047	172
15335	270	15825	271	16012	122	16091	125	16311	139	17048	177
15340	108	15830	109	16013	122	16095	127	16311	139	17049	177
15340	270	15830	271	16013	122	16099	124	16311	139	17050	139
15415	108	15850	109	16016	122	16100	124	16312	139	17050	181
15415	270	15850	271	16017	122	16105	124	16312	139	17051	177
15418	108	15853	109	16019	122	16110	124	16315	137	17052	177
15418	270	15853	271	16021	128	16115	124	16315	137	17053	177
15420	108	15855	109	16023	127	16120	124	16319	139	17054	177
15420	270	15855	271	16024	128	16125	124	16320	139	17055	177
15425	108	15860	109	16025	125	16130	126	16321	139	17056	177
15425	270	15860	271	16026	128	16131	124	16321	229	17057	177
15430	108	15870	109	16028	128	16135	126	16401	181	17058	177
15430	270	15870	271	16029	125	16136	125	16405	181	17059	176
15510	108	15880	109	16030	128	16137	125	16406	181	17060	176
15510	270	15880	271	16031	128	16140	126	16407	181	17061	176
15515	108	15885	256	16032	128	16141	128	16408	181	17062	176
15515	270	15886	256	16033	127	16142	125	16420	181	17063	175
15518	108	15886	349	16034	126	16143	125	16500	176	17064	175
15518	270	15887	256	16035	127	16144	125	16501	176	17065	175
15520	108	15887	349	16036	129	16145	125	16502	176	17066	175
15520	270	15888	256	16037	127	16146	125	16990	136	17067	175
15525	108	15888	349	16039	127	16147	126	16990	320	17068	175
15525	270	15889	256	16041	129	16150	125	16991	136	17069	175
15530	108	15893	109	16042	129	16151	125	16991	320	17070	175
15530	270	15893	271	16042	279	16198	131	16998	122	17071	175
15535	108	15894	109	16043	128	16199	131	16999	122	17072	175
15535	270	15894	271	16044	126	16201	132	17001	171	17075	175
15540	108	15895	109	16046	128	16202	173	17002	171	17076	175
15540	270	15895	271	16049	129	16205	173	17003	171	17077	175
15615	108	15904	111	16050	129	16206	173	17004	171	17078	177
15615	270	15906	111	16051	129	16208	173	17005	171	17079	176
15620	108	15908	111	16052	129	16209	133	17006	171	17080	176
15620	270	15910	111	16053	128	16209	365	17007	171	17081	176
15625	108	15912	111	16054	129	16210	132	17008	171	17082	176
15625	270	15915	111	16055	128	16211	132	17009	171	17083	178
15630	108	15920	111	16056	278	16212	132	17010	171	17084	176
15630	270	15954	111	16057	126	16218	133	17011	171	17085	176
15710	109	15956	111	16058	126	16219	133	17012	176	17086	176
15710	270	15958	111	16059	129	16220	133	17013	176	17087	172
15715	109	15960	111	16060	130	16221	133	17014	176	17089	178
15715	270	15962	111	16061	130	16222	133	17015	178	17090	178
15720	109	15965	111	16062	130	16223	133	17016	178	17091	178
15720	270	15970	111	16063	130	16224	134	17017	178	17092	178
15725	109	15980	111	16064	130	16225	132	17019	178	17093	178
15725	270	15981	111	16065	130	16226	134	17020	177	17094	171
15730	109	15983	100	16066	124	16227	134	17021	177	17095	171
15730	270	15985	100	16066	130	16228	134	17022	177	17096	171
15735	109	15988	100	16067	130	16229	132	17023	175	17097	171
15735	270	15989	100	16068	130	16230	132	17024	171	17098	171
15740	109	15990	111	16069	129	16231	132	17025	174	17099	171
15740	270	15991	111	16070	129	16231	135	17026	137	17100	171
15754	110	15992	111	16070	131	16232	134	17027	137	17101	169
15756	110	15993	111	16071	127	16232	174	17028	177	17102	169
15758	110	15996	110	16071	130	16234	132	17029	176	17103	169
15760	110	15997	110	16072	130	16235	133	17033	176	17104	169
15762	110	15998	110	16073	131	16236	133	17034	175	17105	169
15768	110	15999	110	16074	126	16281	127	17035	175	17108	171
15770	110	16002	122	16074	131	16282	127	17036	175	17109	175

number of item	page	number of item	page	number of item	page	number of item	page	number of item	page	number of item	page
17110	171	17238	156	17393	160	17528	165	17622	164	17831	159
17111	179	17240	158	17394	160	17532	166	17623	164	17832	159
17112	179	17241	158	17395	160	17533	166	17624	164	17835	159
17113	179	17242	158	17396	160	17534	166	17625	164	17836	159
17116	179	17243	158	17397	160	17539	165	17626	164	17837	159
17117	179	17244	158	17398	160	17548	164	17628	164	17838	159
17121	179	17245	155	17400	161	17549	164	17629	164	17839	159
17122	179	17247	153	17401	160	17550	164	17630	164	17840	159
17125	172	17250	161	17402	160	17551	164	17631	164	17841	159
17126	172	17255	161	17405	160	17552	164	17632	164	17842	159
17127	172	17259	153	17406	160	17553	164	17633	164	17843	159
17128	172	17260	153	17407	160	17554	164	17640	166	17844	159
17130	172	17261	167	17410	160	17555	164	17642	166	17845	159
17133	172	17262	167	17411	160	17556	164	17643	166	17846	159
17135	172	17292	158	17412	160	17557	164	17644	166	17847	159
17137	172	17294	158	17413	160	17558	164	17645	166	17848	159
17138	172	17295	158	17414	160	17559	164	17650	166	17849	159
17140	169	17296	158	17415	160	17560	164	17651	166	17850	159
17142	169	17297	158	17416	160	17561	164	17652	166	17851	159
17145	169	17298	158	17420	160	17562	164	17653	166	17852	159
17146	169	17299	158	17421	160	17563	164	17654	166	17853	159
17148	169	17300	178	17422	160	17564	164	17655	166	17854	159
17150	175	17301	178	17427	161	17565	164	17656	166	17855	159
17151	175	17302	178	17450	167	17566	164	17657	166	17856	159
17158	181	17303	178	17451	167	17567	164	17658	166	17860	159
17159	181	17304	178	17452	167	17568	164	17659	166	17861	159
17160	181	17305	178	17454	168	17569	164	17660	164	17862	159
17165	179	17306	178	17455	161	17570	164	17661	164	17863	159
17167	179	17308	159	17455	168	17571	164	17662	164	17864	159
17169	179	17309	159	17456	168	17572	164	17663	164	17865	159
17170	179	17310	159	17458	168	17573	164	17664	164	17866	159
17172	178	17311	159	17459	168	17574	164	17665	164	17867	159
17175	180	17312	159	17460	164	17575	164	17666	164	17868	159
17177	180	17313	159	17461	164	17576	164	17667	164	17869	159
17178	172	17314	159	17462	164	17577	164	17668	164	17870	159
17180	172	17315	159	17463	164	17578	164	17669	164	17871	159
17181	172	17316	159	17464	164	17579	164	17670	164	17872	159
17182	45	17317	159	17465	164	17580	164	17671	164	17873	159
17182	137	17318	159	17467	164	17581	164	17672	164	17874	159
17183	45	17319	159	17468	164	17582	164	17674	164	17875	159
17183	137	17320	159	17469	164	17583	164	17675	164	17876	159
17185	181	17321	159	17470	164	17584	164	17676	164	17877	159
17186	180	17322	159	17471	164	17585	164	17677	164	17878	159
17187	181	17324	159	17472	164	17586	164	17678	164	17879	159
17188	181	17327	159	17473	164	17587	164	17679	164	17880	159
17189	181	17330	159	17475	166	17589	164	17680	168	17881	159
17190	174	17332	159	17476	166	17590	164	17681	168	17882	159
17191	174	17333	159	17480	164	17591	164	17682	168	17883	159
17192	174	17334	159	17481	164	17592	164	17683	164	17884	159
17193	174	17338	167	17482	164	17593	164	17685	165	17885	159
17197	165	17341	178	17483	164	17600	167	17761	164	17886	159
17198	165	17342	178	17484	164	17601	167	17769	164	17887	159
17199	165	17350	162	17485	164	17603	167	17788	164	17888	159
17200	165	17351	162	17486	164	17605	164	17795	164	17889	159
17201	165	17352	162	17487	164	17606	164	17806	164	17890	159
17202	165	17353	162	17488	164	17607	164	17810	161	17891	159
17203	167	17357	162	17489	164	17608	164	17811	161	17892	159
17204	167	17359	162	17490	164	17609	164	17812	161	17895	159
17205	167	17361	162	17491	164	17610	164	17820	159	17896	159
17206	167	17380	161	17492	164	17611	164	17821	159	17897	159
17229	155	17381	161	17493	164	17612	164	17822	159	17898	159
17230	155	17382	160	17494	164	17613	164	17823	159	17904	159
17231	155	17383	160	17495	164	17614	164	17824	159	17905	159
17233	155	17384	160	17496	164	17615	164	17825	159	17907	159
17234	155	17385	160	17501	166	17616	164	17826	159	17910	159
17235	156	17386	160	17506	165	17617	164	17827	159	17914	159
17236	156	17390	160	17508	165	17619	165	17828	159	17916	159
17237	154	17391	160	17512	166	17620	166	17829	159	17922	159
17238	153	17392	160	17526	165	17621	166	17830	159	17924	159

LIST OF ITEMS



number of item	page	number of item	page	number of item	page	number of item	page	number of item	page	number of item	page
17926	159	18302	143	18498	163	18638	147	18828	148	18971	160
17930	159	18303	143	18499	163	18639	147	18829	148	18993	150
17934	159	18304	143	18500	163	18640	147	18830	148	18994	150
17935	159	18310	140	18501	162	18641	147	18831	148	19001	197
17943	159	18311	140	18508	163	18645	147	18832	148	19002	197
17944	159	18312	140	18510	162	18646	147	18835	148	19003	197
17970	148	18313	140	18511	162	18680	147	18836	148	19004	197
17971	148	18321	140	18512	162	18685	147	18837	148	19005	197
17972	148	18322	140	18513	162	18710	146	18838	148	19006	197
17973	148	18340	141	18514	162	18711	146	18839	148	19008	197
17974	148	18350	140	18515	162	18712	146	18840	148	19010	197
17975	148	18351	140	18516	162	18715	146	18841	148	19015	197
17976	148	18352	140	18518	162	18716	146	18842	148	19020	197
17980	148	18353	140	18519	162	18717	146	18843	148	19021	195
17981	148	18354	140	18520	162	18720	146	18844	148	19022	195
17982	148	18355	140	18521	162	18721	146	18845	148	19023	195
17983	148	18356	140	18522	162	18722	146	18846	148	19024	195
18062	142	18357	140	18523	162	18723	146	18847	148	19025	195
18063	142	18358	140	18524	162	18724	146	18850	148	19026	195
18064	142	18359	140	18527	162	18725	146	18851	148	19028	195
18065	142	18360	140	18567	162	18750	147	18852	148	19030	195
18066	142	18400	143	18572	162	18751	147	18853	148	19031	195
18067	142	18401	143	18575	162	18753	147	18855	148	19032	195
18070	142	18402	141	18576	162	18755	147	18856	148	19034	195
18071	142	18403	141	18577	162	18760	147	18860	148	19036	195
18072	142	18404	141	18578	162	18761	147	18861	148	19041	195
18075	142	18408	145	18579	162	18762	147	18862	148	19042	195
18076	142	18409	145	18580	162	18763	147	18863	148	19043	195
18077	142	18410	142	18581	162	18764	147	18864	148	19044	195
18080	142	18411	142	18582	162	18765	147	18865	148	19045	195
18081	142	18413	142	18583	162	18766	147	18866	148	19046	195
18082	142	18415	144	18584	162	18767	147	18867	148	19050	197
18083	142	18416	144	18585	162	18768	147	18868	148	19051	197
18084	142	18417	144	18587	162	18769	147	18869	148	19052	197
18085	142	18418	143	18588	162	18770	147	18870	148	19053	197
18086	142	18419	144	18589	162	18771	147	18871	148	19054	197
18087	142	18420	144	18593	162	18772	147	18872	148	19055	197
18088	142	18421	152	18600	149	18775	147	18873	148	19056	197
18089	142	18422	141	18601	149	18776	147	18874	148	19057	197
18090	142	18423	142	18602	149	18777	147	18900	151	19058	195
18091	142	18424	141	18603	158	18795	149	18901	151	19059	195
18092	142	18425	140	18604	161	18796	149	18905	151	19060	196
18101	143	18426	145	18605	149	18797	149	18906	151	19061	196
18102	143	18427	145	18607	149	18798	149	18907	152	19062	196
18103	143	18428	115	18608	144	18799	149	18908	151	19063	196
18104	143	18429	115	18609	150	18800	148	18909	151	19064	196
18105	143	18430	152	18610	150	18801	148	18910	145	19065	196
18106	143	18431	144	18611	150	18802	148	18915	152	19066	195
18107	143	18432	146	18612	150	18803	148	18920	160	19067	195
18108	143	18433	144	18613	150	18804	148	18921	160	19068	195
18110	143	18434	140	18614	150	18805	148	18922	160	19069	195
18113	140	18435	145	18615	150	18806	148	18925	160	19070	195
18114	140	18437	145	18618	150	18807	148	18926	160	19071	195
18115	140	18440	152	18619	149	18810	148	18927	160	19074	195
18116	140	18445	173	18619	161	18811	148	18928	160	19075	195
18118	140	18450	143	18620	147	18812	148	18929	160	19076	195
18120	140	18451	143	18621	147	18813	148	18930	160	19077	195
18124	140	18455	143	18623	147	18814	148	18931	160	19081	195
18125	140	18456	143	18625	147	18815	148	18934	160	19082	195
18201	143	18460	143	18627	147	18816	148	18939	160	19083	195
18202	143	18476	162	18628	147	18817	148	18948	160	19084	195
18203	143	18490	163	18630	147	18820	148	18950	160	19085	195
18204	143	18491	163	18631	147	18821	148	18951	160	19086	195
18210	140	18492	163	18632	147	18822	148	18954	160	19088	195
18211	140	18493	163	18633	147	18823	148	18955	160	19090	195
18212	140	18494	162	18634	147	18824	148	18956	160	19092	195
18215	140	18495	162	18635	147	18825	148	18960	160	19095	195
18216	140	18496	163	18636	147	18826	148	18961	160	19096	195
18301	143	18497	163	18637	147	18827	148	18963	160	19097	195

number of item	page	number of item	page	number of item	page	number of item	page	number of item	page	number of item	page
19098	195	19394	317	19473	202	19580	56	19643	56	19704	57
19100	196	19395	317	19474	202	19585	56	19644	56	19705	57
19106	195	19396	317	19477	202	19585	56	19645	56	19705	57
19108	195	19397	317	19478	202	19586	56	19645	56	19706	57
19109	195	19398	197	19480	202	19587	56	19646	56	19707	57
19110	200	19399	197	19481	202	19588	56	19647	56	19708	57
19115	44	19400	201	19483	202	19589	56	19648	56	19708	57
19115	197	19400	251	19485	201	19590	56	19649	56	19709	57
19124	196	19401	201	19486	201	19590	56	19650	56	19710	57
19136	196	19401	251	19487	201	19591	56	19650	56	19711	57
19148	196	19402	201	19490	135	19593	56	19651	56	19711	57
19149	196	19402	251	19491	135	19594	56	19652	56	19712	57
19150	196	19403	201	19492	135	19595	56	19653	56	19713	57
19151	196	19403	251	19493	135	19595	56	19654	56	19713	57
19202	198	19404	201	19494	135	19596	56	19655	56	19714	57
19208	199	19404	251	19495	135	19597	56	19656	56	19715	57
19209	199	19405	201	19496	135	19598	56	19657	56	19716	57
19211	199	19405	251	19497	135	19599	56	19658	56	19717	57
19245	198	19406	201	19498	135	19600	56	19659	56	19718	57
19246	198	19406	251	19499	135	19600	56	19660	56	19718	57
19247	198	19407	201	19501	135	19601	56	19661	56	19719	57
19248	198	19407	251	19502	135	19603	56	19662	56	19720	57
19249	198	19408	201	19510	134	19604	56	19663	56	19721	57
19251	199	19408	251	19515	134	19605	56	19664	56	19722	57
19252	199	19409	201	19520	134	19605	56	19665	56	19723	57
19253	199	19409	251	19530	56	19606	56	19669	56	19723	57
19254	199	19410	201	19530	56	19607	56	19670	57	19724	57
19255	199	19411	201	19535	56	19608	56	19671	57	19725	57
19265	199	19412	201	19535	56	19609	56	19672	57	19726	57
19270	199	19415	200	19536	56	19610	56	19673	57	19727	57
19271	199	19416	200	19537	56	19610	56	19673	57	19728	57
19272	199	19418	201	19538	56	19611	56	19674	57	19728	57
19281	199	19419	201	19539	56	19612	56	19675	57	19729	57
19290	199	19420	200	19540	56	19613	56	19676	57	19730	57
19293	199	19421	200	19540	56	19614	56	19677	57	19731	57
19294	199	19422	200	19543	56	19615	56	19678	57	19732	57
19295	199	19423	200	19544	56	19615	56	19678	57	19733	57
19297	199	19424	200	19545	56	19616	56	19679	57	19733	57
19301	316	19425	200	19545	56	19617	56	19680	57	19734	57
19303	196	19426	200	19550	56	19618	56	19681	57	19735	57
19306	317	19427	200	19550	56	19619	56	19682	57	19736	57
19308	317	19429	201	19552	56	19620	56	19683	57	19737	57
19310	317	19430	197	19552	56	19620	56	19683	57	19738	57
19312	317	19431	197	19554	56	19621	56	19684	57	19738	57
19314	317	19432	197	19555	56	19622	56	19685	57	19739	57
19326	316	19433	197	19555	56	19623	56	19686	57	19740	57
19328	316	19434	197	19557	56	19624	56	19687	57	19741	57
19330	316	19435	197	19558	56	19625	56	19688	57	19742	57
19332	316	19436	201	19559	56	19625	56	19688	57	19743	57
19333	316	19440	197	19560	56	19626	56	19689	57	19743	57
19335	316	19441	197	19560	56	19627	56	19690	57	19744	57
19337	316	19442	197	19562	56	19628	56	19691	57	19745	57
19340	316	19443	197	19562	56	19629	56	19692	57	19746	57
19370	317	19450	135	19564	56	19630	56	19693	57	19747	57
19371	317	19451	135	19565	56	19630	56	19693	57	19748	57
19374	317	19455	135	19565	56	19631	56	19694	57	19748	57
19380	316	19457	135	19567	56	19632	56	19695	57	19749	57
19381	316	19458	135	19568	56	19633	56	19695	57	19750	57
19382	316	19459	135	19568	56	19634	56	19696	57	19751	57
19383	316	19460	201	19570	56	19635	56	19697	57	19752	57
19384	316	19460	251	19570	56	19635	56	19698	57	19753	57
19385	316	19462	317	19574	56	19636	56	19698	57	19753	57
19387	316	19463	317	19575	56	19637	56	19699	57	19754	57
19388	316	19464	317	19575	56	19638	56	19700	57	19755	57
19389	316	19465	317	19576	56	19639	56	19701	57	19756	57
19390	316	19469	317	19577	56	19640	56	19701	57	19757	57
19391	316	19470	201	19578	56	19640	56	19702	57	19758	57
19392	316	19470	251	19579	56	19641	56	19703	57	19758	57
19393	317	19472	202	19580	56	19642	56	19703	57	19759	57

LIST OF ITEMS



number of item	page	number of item	page	number of item	page	number of item	page	number of item	page	number of item	page
19760	57	20300	59	20489	61	20751	67	20896	63	21110	75
19761	57	20305	59	20490	61	20752	67	20897	63	21111	75
19762	57	20310	59	20491	61	20753	67	20898	63	21112	75
19763	57	20311	59	20492	61	20754	67	20899	63	21115	75
19763	57	20315	60	20493	61	20755	67	20901	64	21118	75
19764	57	20316	59	20494	61	20756	67	20905	64	21123	75
19765	57	20317	59	20495	61	20757	67	20910	64	21130	75
19766	57	20320	60	20496	61	20758	67	20911	63	21135	75
19767	57	20321	60	20508	67	20759	67	20912	63	21140	75
19768	57	20333	58	20510	67	20760	67	20913	63	21150	75
19768	57	20334	58	20511	67	20761	67	20915	63	21180	75
19769	57	20335	58	20512	67	20762	67	20916	63	21190	75
19770	57	20336	58	20513	67	20764	67	20917	63	21192	77
19771	57	20337	58	20514	67	20765	67	20918	63	21194	77
19772	57	20338	58	20515	67	20766	67	20919	63	21195	75
19772	57	20340	60	20516	67	20767	67	20920	63	21200	74
19773	57	20350	202	20520	67	20768	67	20921	63	21201	74
19774	57	20360	139	20521	67	20769	67	20922	63	21203	74
19775	57	20361	139	20522	67	20770	67	20923	63	21204	74
19776	57	20363	180	20523	67	20771	67	20924	63	21205	74
19776	57	20364	180	20524	67	20772	67	20932	69	21209	74
19777	57	20365	29	20525	67	20773	67	20936	69	21210	75
19778	57	20379	29	20526	67	20774	67	20937	69	21211	75
19779	57	20380	60	20673	67	20775	67	20938	69	21212	75
19780	57	20381	64	20674	67	20776	67	20939	69	21215	75
19781	57	20385	62	20675	67	20777	67	20940	69	21218	75
19781	57	20386	62	20676	67	20778	67	20941	69	21219	75
19782	57	20387	62	20677	67	20779	67	20942	69	21220	75
19783	57	20390	62	20678	67	20780	67	20943	69	21223	75
19783	57	20391	62	20680	67	20781	67	20944	69	21224	75
19784	57	20394	62	20682	67	20782	67	20945	69	21230	74
19785	57	20395	62	20684	67	20783	67	20946	69	21231	74
19786	57	20396	62	20685	67	20784	67	20947	69	21234	74
19786	57	20397	62	20686	67	20785	67	20948	69	21235	74
19787	57	20400	58	20687	67	20786	67	20949	69	21238	74
19788	57	20401	58	20688	67	20787	67	20950	68	21301	75
19789	57	20402	58	20690	67	20788	67	20952	68	21303	75
19790	57	20403	58	20691	67	20789	67	20954	68	21306	77
19791	57	20404	58	20692	67	20790	67	20956	69	21308	77
19792	57	20405	58	20694	67	20791	67	20957	63	21311	75
19793	57	20406	58	20696	67	20792	67	20958	63	21312	75
19794	57	20407	58	20697	67	20793	67	20960	29	21315	75
19795	57	20408	58	20698	67	20794	67	20961	29	21318	75
19796	57	20409	58	20724	63	20795	67	20963	29	21323	75
19797	57	20410	58	20725	63	20796	67	20965	29	21324	75
19798	57	20411	58	20726	63	20797	67	20966	29	21326	75
19799	57	20412	58	20727	63	20798	67	20967	166	21327	75
19800	57	20413	58	20728	63	20799	67	20968	166	21411	75
19801	57	20414	58	20729	63	20805	68	20970	202	21412	75
19802	57	20415	58	20730	63	20820	68	20971	202	21415	75
19841	58	20416	58	20731	63	20825	67	20972	202	21418	75
19842	58	20417	58	20732	63	20855	67	20973	202	21423	75
19845	58	20418	58	20733	63	20861	67	20980	63	21424	75
19885	58	20419	58	20734	63	20862	67	20981	63	21425	76
19895	58	20420	58	20735	63	20870	67	20982	63	21426	76
20210	64	20421	58	20736	63	20871	67	20983	63	21427	76
20220	57	20422	58	20737	63	20872	67	20984	63	21428	76
20225	57	20423	58	20738	63	20873	67	20990	69	21430	76
20230	57	20424	58	20739	63	20874	67	20991	69	21431	76
20235	57	20425	58	20740	63	20875	67	20992	69	21432	76
20240	57	20426	58	20741	63	20876	67	20996	68	21435	76
20245	57	20427	58	20742	150	20877	67	20997	69	21436	76
20250	57	20428	58	20743	29	20878	67	20999	68	21437	76
20255	57	20429	58	20743	149	20879	67	21010	75	21440	64
20260	57	20430	58	20744	29	20880	67	21011	75	21441	64
20270	57	20450	64	20745	29	20881	67	21012	75	21442	64
20280	57	20460	64	20748	67	20890	68	21015	75	21443	64
20290	57	20487	61	20749	67	20891	68	21018	75	21444	64
20296	57	20488	61	20750	67	20895	68	21023	75	21445	64

number of item	page	number of item	page	number of item	page	number of item	page	number of item	page	number of item	page
21446	64	21803	78	22012	81	22083	82	22170	189	22277	76
21450	66	21804	78	22013	81	22084	82	22171	189	22280	76
21451	66	21805	78	22014	81	22085	82	22172	189	22281	76
21452	66	21806	78	22015	81	22086	187	22173	189	22285	76
21453	66	21807	65	22016	81	22087	83	22174	189	22286	76
21454	66	21807	78	22017	81	22088	82	22178	188	22294	76
21530	64	21808	65	22018	81	22090	82	22180	188	22300	86
21531	63	21808	78	22019	81	22091	83	22181	188	22301	86
21532	63	21809	79	22020	81	22092	83	22182	188	22302	86
21533	63	21810	84	22021	81	22093	83	22183	188	22303	86
21534	63	21811	84	22022	81	22095	82	22184	188	22305	86
21535	63	21812	84	22023	81	22096	84	22185	188	22307	86
21536	63	21813	84	22024	81	22097	84	22186	188	22309	86
21540	66	21814	84	22025	81	22098	84	22188	189	22310	86
21541	66	21831	84	22026	81	22099	84	22189	189	22311	86
21701	84	21832	84	22027	81	22100	85	22190	189	22312	86
21702	84	21834	84	22028	81	22101	85	22196	189	22313	86
21703	84	21850	85	22029	81	22102	85	22197	189	22314	86
21704	84	21851	85	22030	81	22103	85	22198	189	22315	86
21705	84	21852	85	22031	81	22104	85	22199	189	22316	86
21706	84	21853	85	22032	82	22105	85	22200	70	22317	86
21709	84	21854	85	22033	187	22106	85	22201	70	22318	86
21715	84	21855	85	22034	187	22107	85	22202	189	22319	86
21716	84	21856	85	22035	187	22108	85	22203	189	22320	86
21717	84	21857	85	22036	187	22109	85	22204	189	22322	86
21718	84	21858	85	22037	80	22110	85	22205	189	22324	86
21719	84	21859	85	22038	80	22111	85	22206	188	22326	86
21720	84	21860	85	22039	81	22112	85	22207	188	22328	86
21721	84	21861	85	22040	81	22113	85	22208	188	22329	86
21724	84	21862	85	22041	83	22115	85	22209	188	22332	86
21732	84	21863	85	22042	83	22116	85	22211	77	22333	86
21734	84	21864	85	22043	83	22117	85	22212	77	22335	86
21735	84	21900	80	22044	83	22119	85	22215	77	22337	86
21736	84	21901	80	22045	84	22120	293	22216	77	22340	86
21737	84	21902	80	22046	84	22121	293	22217	77	22343	86
21740	84	21903	80	22047	84	22122	293	22218	77	22345	86
21741	84	21904	80	22048	84	22123	293	22219	77	22350	86
21742	84	21905	80	22049	84	22124	293	22220	77	22351	86
21743	84	21906	80	22050	84	22125	293	22222	77	22355	86
21744	84	21907	80	22051	84	22126	293	22224	77	22357	86
21750	84	21908	80	22052	84	22129	293	22225	77	22365	86
21751	84	21909	81	22053	84	22130	293	22228	77	22370	86
21752	84	21910	81	22054	84	22132	293	22229	77	22398	86
21753	84	21911	80	22055	84	22133	293	22230	77	22399	86
21754	84	21912	80	22056	84	22134	293	22232	77	22510	56
21760	79	21913	80	22057	84	22135	350	22234	77	22515	56
21761	79	21914	80	22058	81	22136	350	22236	77	22520	56
21762	79	21920	80	22059	81	22137	350	22238	77	22525	56
21763	79	21925	80	22060	83	22138	350	22240	77	22530	56
21764	79	21926	80	22061	83	22140	79	22242	77	22532	56
21780	79	21930	82	22062	83	22141	79	22244	77	22535	56
21781	79	21931	82	22063	83	22142	79	22246	77	22540	56
21782	79	21935	82	22064	83	22143	79	22248	77	22542	56
21783	79	21936	82	22065	83	22145	79	22251	77	22545	56
21784	79	21937	82	22066	83	22146	79	22252	77	22548	56
21786	79	21940	82	22067	85	22147	79	22253	77	22550	56
21787	79	21941	82	22070	83	22148	79	22254	77	22555	56
21788	79	21950	81	22071	83	22150	79	22255	77	22560	56
21789	79	22001	80	22072	83	22151	79	22258	76	22565	56
21790	79	22002	80	22073	83	22155	79	22259	76	22568	56
21792	79	22003	80	22074	83	22156	79	22260	76	22570	56
21793	79	22004	80	22075	85	22158	187	22263	76	22575	56
21794	79	22005	80	22076	85	22159	187	22264	76	22580	56
21795	79	22006	80	22077	85	22160	83	22266	76	22585	56
21796	79	22007	80	22078	187	22161	83	22269	76	22590	56
21798	79	22008	80	22079	187	22162	83	22270	76	22595	56
21800	78	22009	80	22080	187	22163	83	22273	76	22600	56
21801	78	22010	80	22081	187	22164	83	22274	76	22602	56
21802	78	22011	80	22082	187	22167	83	22275	76	22605	56

LIST OF ITEMS



number of item	page	number of item	page	number of item	page	number of item	page	number of item	page	number of item	page
22610	56	23658	209	23973	183	24111	190	24197	93	24676	72
22615	56	23660	210	23974	183	24114	191	24301	90	24677	72
22620	56	23661	209	23975	183	24115	191	24302	90	24678	72
22625	56	23664	209	23976	183	24118	93	24303	90	24680	276
22630	56	23670	203	23977	183	24119	93	24304	90	24690	202
22701	82	23671	203	23978	183	24120	93	24305	90	24691	202
22702	82	23672	203	23979	183	24121	190	24306	90	24695	202
22703	82	23673	203	23985	183	24122	190	24308	90	24700	72
22704	82	23674	203	23986	183	24124	190	24310	90	24701	72
22705	82	23675	203	23987	183	24125	190	24312	91	24702	72
22706	82	23676	203	23988	183	24126	190	24313	91	24703	72
22707	82	23677	203	23989	183	24128	193	24314	91	24704	72
23270	239	23678	203	24000	183	24130	192	24315	91	24705	72
23400	212	23679	203	24001	183	24131	192	24316	91	24706	65
23401	212	23680	203	24005	183	24132	134	24320	87	24710	73
23402	212	23681	203	24007	182	24133	192	24321	87	24712	65
23406	212	23682	203	24008	183	24134	191	24322	87	24713	65
23407	212	23683	203	24010	182	24135	192	24325	91	24714	65
23410	212	23684	203	24015	182	24136	192	24410	60	24715	65
23411	212	23685	203	24017	182	24137	192	24411	60	24716	65
23412	212	23730	168	24020	182	24140	192	24412	60	24717	69
23415	212	23731	168	24030	182	24141	192	24415	65	24718	69
23416	212	23732	168	24035	183	24142	192	24419	60	24719	69
23417	212	23734	168	24036	183	24143	191	24420	60	24720	65
23420	205	23735	168	24038	183	24144	191	24422	60	24721	65
23506	204	23736	168	24039	183	24145	191	24425	60	24722	65
23507	204	23760	185	24040	183	24147	191	24429	60	24723	69
23508	204	23761	185	24041	183	24148	192	24432	60	24725	70
23515	204	23762	185	24042	183	24149	191	24435	60	24726	70
23520	204	23763	185	24043	183	24150	192	24437	60	24727	290
23525	204	23764	185	24045	89	24151	192	24444	60	24728	290
23530	204	23800	184	24050	91	24152	193	24451	60	24729	290
23531	204	23840	322	24055	88	24152	315	24457	60	24730	69
23551	204	23845	323	24055	277	24153	190	24464	60	24731	69
23560	204	23846	323	24060	88	24155	194	24468	60	24732	69
23561	204	23847	323	24061	88	24156	194	24476	60	24734	73
23562	204	23875	223	24062	88	24158	194	24483	60	24735	70
23563	204	23875	357	24063	88	24159	194	24620	71	24736	70
23564	204	23904	185	24064	88	24159	293	24621	71	24737	70
23565	204	23906	185	24065	88	24160	93	24622	71	24738	70
23566	204	23908	185	24066	88	24161	93	24623	71	24739	70
23570	203	23910	185	24067	88	24162	93	24624	71	24740	70
23571	203	23912	185	24068	88	24163	93	24627	71	24741	70
23572	203	23914	185	24069	88	24164	93	24630	71	24743	70
23573	203	23920	184	24070	88	24165	93	24633	71	24745	70
23574	203	23922	184	24071	88	24166	93	24636	71	24746	70
23585	203	23923	184	24072	88	24167	93	24638	71	24747	70
23587	203	23924	184	24073	88	24168	93	24640	71	24748	70
23589	203	23925	184	24074	88	24169	93	24642	71	24749	70
23591	203	23927	184	24075	88	24170	190	24643	71	24750	61
23595	204	23928	184	24076	88	24171	192	24647	79	24751	61
23598	204	23945	184	24077	88	24173	192	24648	79	24752	290
23600	205	23950	183	24078	88	24174	194	24649	79	24753	290
23601	205	23951	183	24080	89	24175	194	24650	72	24755	66
23602	205	23952	183	24081	89	24176	194	24651	71	24756	66
23605	205	23953	183	24082	89	24177	194	24652	71	24757	69
23607	205	23954	183	24083	89	24178	194	24655	73	24758	69
23620	205	23955	183	24084	89	24180	93	24658	73	24759	69
23625	203	23960	185	24085	89	24181	194	24661	72	24760	72
23626	203	23961	185	24086	89	24185	93	24663	72	24761	72
23628	203	23962	185	24087	89	24186	93	24665	82	24762	72
23630	203	23963	185	24098	89	24187	93	24666	82	24763	72
23632	203	23964	185	24099	89	24188	93	24667	82	24764	72
23635	203	23965	185	24100	190	24189	93	24670	72	24765	72
23637	204	23966	185	24102	190	24190	194	24671	72	24766	72
23650	210	23967	185	24104	190	24190	293	24672	72	24767	72
23652	208	23970	183	24108	93	24192	93	24673	72	24768	72
23655	210	23971	183	24109	93	24195	93	24674	72	24769	72
23657	208	23972	183	24110	190	24196	93	24675	72	24770	70

number of item	page	number of item	page	number of item	page	number of item	page	number of item	page	number of item	page
24771	70	25206	305	28032	11	31082	245	31502	252	32166	248
24772	70	25212	305	28035	13	31091	244	31503	252	32167	248
24773	70	25215	305	28040	12	31101	244	31505	247	32168	248
24774	70	25220	305	28045	12	31111	244	31506	247	32169	248
24775	71	25224	305	28050	14	31121	244	31507	247	32170	247
24776	72	25230	305	28055	14	31131	244	31510	247	32171	248
24777	71	25240	305	28060	17	31132	244	31511	247	32172	248
24778	71	25248	305	28061	17	31140	244	31512	247	32173	247
24779	72	25260	305	28065	17	31141	244	31513	247	32174	248
24780	73	25296	305	28070	10	31142	244	31514	247	32176	248
24781	73	25350	305	28075	15	31143	244	31515	247	32186	248
24782	73	25369	305	28076	18	31144	244	31517	247	32196	248
24783	73	25370	305	28080	19	31145	244	31519	252	32206	248
24784	73	25371	305	28081	19	31146	244	31520	249	32216	248
24785	73	25372	305	28083	19	31148	244	31521	249	32226	248
24786	73	25373	305	28085	19	31150	245	31522	249	32234	248
24787	73	25374	305	28086	19	31151	245	31523	249	32240	248
24788	73	25376	305	28090	20	31155	245	31524	249	32265	250
24789	73	25378	305	28101	21	31218	247	31541	249	32268	251
24790	72	25379	305	28102	20	31220	246	31551	249	32269	251
24791	72	25380	305	28103	20	31221	246	31552	249	32270	250
24792	72	25400	305	28104	21	31222	246	31553	249	32273	250
24793	72	25410	305	28210	28	31231	246	31555	249	32283	250
24794	72	26028	111	28213	28	31232	246	31556	249	32285	250
24795	71	26201	113	28215	27	31233	246	31557	249	32293	250
24796	72	26203	112	28218	28	31234	246	31558	249	32295	251
24797	71	26204	113	28220	25	31235	246	31559	249	32296	251
24798	73	26205	112	28221	23	31270	246	31601	253	32297	251
24799	71	26209	114	28223	28	31271	246	31602	253	32298	251
25001	305	26211	113	28225	24	31280	246	31603	253	32301	251
25002	305	26216	114	28228	28	31281	246	31610	249	32302	251
25003	305	26217	114	28229	28	31320	247	31641	253	32311	255
25004	305	26218	114	28230	26	31322	247	31651	253	32312	254
25005	305	26219	114	28233	28	31330	246	31655	253	32313	251
25006	305	26520	115	28240	36	31332	246	32001	250	32314	254
25009	305	26521	115	28267	29	31334	246	32002	250	32315	255
25012	305	26705	228	28275	50	31340	246	32003	250	32316	255
25015	305	26706	228	28278	50	31341	246	32013	250	32317	254
25016	305	26707	228	28280	50	31343	246	32014	250	32318	255
25020	305	26720	228	28282	50	31360	246	32015	250	32319	255
25024	305	26721	228	28340	37	31362	246	32016	250	32320	254
25025	305	26722	228	28342	37	31380	246	32018	250	32321	255
25030	305	26730	272	28345	37	31382	246	32020	250	32322	255
25040	305	26731	272	28346	37	31390	246	32021	250	32323	255
25048	305	26735	272	30003	256	31392	246	32022	253	32324	255
25060	305	26736	272	30003	259	31400	246	32023	253	32325	255
25096	305	26740	273	30004	256	31402	246	32024	250	32326	255
25150	305	26775	292	30004	259	31403	246	32026	250	32327	254
25153	305	26780	273	30005	256	31404	246	32037	251	32328	255
25155	305	26781	273	30005	259	31452	253	32038	251	32329	254
25160	305	26782	273	30007	256	31453	253	32040	253	32330	255
25162	305	26783	273	30007	259	31454	253	32041	253	32331	255
25163	305	26973	216	31005	245	31455	247	32042	253	32332	254
25164	305	26974	216	31006	245	31456	247	32043	253	32333	254
25167	305	26975	216	31007	245	31461	248	32044	253	32335	255
25169	305	26976	216	31008	245	31467	248	32050	253	32337	254
25170	305	26977	216	31009	245	31468	248	32051	253	32338	254
25171	305	28000	4	31011	245	31471	248	32052	253	33168	254
25179	305	28001	5	31021	245	31481	248	32053	253	33275	296
25180	305	28002	5	31031	245	31491	248	32060	250	34005	256
25181	305	28003	6	31041	245	31493	248	32062	250	34006	256
25182	305	28004	6	31051	245	31494	248	32064	250	34007	256
25183	305	28005	7	31052	245	31495	248	32066	250	34027	255
25184	305	28006	7	31053	245	31496	248	32089	251	34028	255
25186	305	28007	8	31061	245	31497	252	32161	248	34033	260
25188	305	28008	8	31062	245	31498	248	32162	248	34041	256
25189	305	28021	9	31071	245	31499	248	32163	248	34051	256
25190	305	28025	9	31072	245	31500	248	32164	248	34053	256
25195	305	28030	11	31081	245	31501	252	32165	248	34061	256

LIST OF ITEMS



number of item	page	number of item	page	number of item	page	number of item	page	number of item	page	number of item	page
34071	256	34405	258	35082	263	35345	40	36130	277	37115	291
34081	256	34406	259	35085	262	35345	286	36136	277	37117	278
34091	256	34407	259	35086	262	35346	41	36138	277	37119	291
34101	256	34409	259	35087	262	35346	288	36139	277	37120	291
34111	256	34410	259	35091	262	35347	41	36140	277	37121	296
34115	256	34411	259	35092	262	35347	288	36145	274	37122	296
34116	256	34412	259	35093	262	35348	40	36160	274	37123	364
34117	256	34413	259	35094	263	35348	286	36175	274	37124	364
34121	256	34414	259	35095	263	35360	46	36190	274	37125	282
34122	256	34415	258	35096	263	35361	46	36191	274	37126	282
34132	256	34416	258	35103	264	35362	46	36195	277	37127	282
34142	256	34417	259	35113	264	35500	266	36199	274	37129	364
34152	256	34418	259	35123	264	35501	266	36200	274	37130	281
34153	256	34419	258	35125	264	35502	266	36300	209	37131	281
34154	256	34420	258	35126	264	35503	266	36308	292	37132	281
34155	256	34421	259	35127	264	35504	266	36310	273	37135	231
34156	256	34422	259	35142	262	35505	266	36312	292	37139	231
34157	256	34423	259	35300	38	35506	266	36318	283	37140	231
34158	256	34424	259	35300	261	35507	266	36319	283	37141	231
34159	256	34425	259	35305	39	35508	266	36325	283	37142	231
34160	256	34426	259	35305	262	35510	266	36326	16	37143	231
34200	252	34428	259	35310	38	35511	266	36326	283	37144	231
34201	252	34429	259	35310	261	35512	266	36328	16	37145	231
34202	252	34439	258	35311	38	35514	266	36329	16	37148	282
34203	252	34440	258	35311	261	35515	266	36410	208	37149	282
34221	260	34441	258	35315	39	35516	266	37005	302	37150	282
34223	260	34442	258	35315	262	35517	266	37006	279	37151	282
34231	260	34443	258	35316	38	35518	267	37006	279	37152	282
34235	260	34445	258	35316	261	35519	267	37007	279	37153	282
34237	260	34446	258	35317	38	35524	267	37007	279	37154	282
34238	260	34447	258	35317	261	35525	267	37008	279	37155	280
34241	260	34448	259	35318	38	35527	267	37009	279	37156	280
34243	260	34449	258	35318	261	35532	267	37011	278	37157	280
34251	260	34450	258	35319	38	35533	267	37012	279	37158	282
34261	260	34451	258	35319	261	35539	267	37021	278	37162	281
34262	260	34452	259	35320	50	35540	267	37025	278	37166	273
34265	260	34453	258	35322	50	35542	267	37025	278	37170	281
34271	252	34454	258	35323	42	35552	267	37026	278	37171	281
34272	252	34455	259	35323	289	35553	267	37026	278	37172	281
34273	252	34456	259	35325	42	35555	267	37028	278	37173	282
34274	252	34457	259	35325	289	35603	269	37028	278	37174	282
34275	252	34458	259	35326	42	35604	269	37029	278	37175	281
34276	252	34480	258	35326	289	35605	269	37029	278	37176	281
34280	252	34481	258	35327	42	35833	52	37031	253	37177	282
34281	252	34482	258	35327	289	35845	52	37041	253	37178	282
34282	252	34485	258	35328	42	35850	52	37050	278	37185	281
34283	252	34486	258	35328	42	36014	276	37051	253	37186	281
34284	252	34490	259	35328	289	36024	276	37052	278	37187	281
34285	252	34491	259	35328	289	36034	276	37053	278	37188	281
34300	292	34496	259	35329	42	36035	276	37054	278	37189	281
34301	252	34500	260	35329	42	36036	276	37055	278	37190	281
34303	292	35006	263	35329	289	36046	276	37065	284	37192	281
34304	252	35007	263	35329	289	36056	277	37066	284	37195	282
34305	252	35011	264	35330	40	36057	277	37067	284	37196	282
34305	292	35012	263	35330	287	36058	277	37068	284	37197	282
34306	252	35013	263	35331	41	36059	277	37069	284	37198	282
34306	292	35015	264	35331	288	36076	275	37070	284	37199	282
34307	252	35021	264	35332	41	36077	275	37094	284	37200	280
34307	292	35023	262	35332	288	36080	275	37095	284	37201	280
34308	252	35038	262	35333	41	36081	275	37096	284	37202	280
34308	292	35048	264	35333	288	36082	275	37097	284	37203	280
34315	293	35058	262	35334	41	36085	275	37098	284	37204	280
34316	131	35059	263	35334	288	36086	275	37101	253	37205	280
34316	293	35068	264	35335	42	36087	275	37102	280	37210	280
34400	258	35069	263	35335	289	36102	275	37105	280	37211	280
34401	258	35070	263	35336	41	36103	275	37106	280	37212	280
34402	259	35078	263	35336	288	36105	275	37107	280	37216	291
34403	259	35079	263	35344	41	36126	277	37111	253	37217	291
34404	258	35081	263	35344	287	36128	277	37114	291	37218	291

number of item	page	number of item	page	number of item	page	number of item	page	number of item	page	number of item	page
37220	280	37344	236	38022	299	38949	224	39217	290	42179	353
37230	292	37345	236	38024	297	38950	290	39218	290	42180	354
37231	292	37350	235	38025	298	38951	290	39219	290	42181	354
37232	292	37500	267	38026	279	38952	290	39238	292	42182	354
37233	292	37501	267	38027	297	38953	290	39240	290	42185	354
37234	292	37505	267	38028	297	38954	290	39241	290	42186	354
37235	292	37506	267	38030	299	38955	224	39242	290	42187	354
37236	291	37509	268	38031	299	38956	224	39243	290	42188	354
37237	291	37510	268	38032	297	38957	224	39244	290	42190	224
37238	291	37511	268	38042	279	38958	224	39245	292	42190	354
37239	291	37512	268	38045	279	38959	224	40050	353	42201	355
37243	303	37515	268	38050	223	38960	224	40051	353	42202	355
37244	303	37516	268	38052	223	38961	224	40052	353	42203	355
37245	303	37517	268	38054	223	38963	226	40053	353	42207	355
37246	303	37518	268	38055	223	38964	225	40054	353	42208	355
37247	303	37527	268	38060	223	38965	225	40055	353	42209	355
37248	303	37530	268	38063	223	38966	225	40056	353	42210	355
37250	303	37532	268	38065	223	38968	224	40057	353	42211	355
37251	303	37533	268	38095	223	38969	226	40058	353	42212	355
37252	303	37539	269	38096	223	38970	290	40059	353	42213	355
37253	303	37541	269	38097	223	38971	290	40060	353	42214	355
37255	225	37545	307	38895	284	38972	226	40075	353	42217	355
37256	225	37546	307	38896	284	38973	226	40076	353	42218	355
37257	225	37549	210	38899	284	38975	226	40077	353	42219	355
37258	225	37553	212	38900	284	38980	224	40100	352	42220	355
37259	225	37560	209	38901	285	38981	224	40120	352	42221	355
37263	225	37564	269	38902	285	38985	226	41050	352	42228	355
37264	225	37570	192	38903	285	38990	225	41080	352	42229	355
37266	225	37570	209	38904	285	38991	225	41081	352	42230	355
37267	225	37611	53	38905	285	38995	225	41082	352	42244	355
37268	225	37615	53	38906	285	39000	296	41083	352	42248	355
37270	225	37616	53	38907	284	39001	296	41100	352	42249	355
37271	225	37647	218	38908	284	39002	296	41101	352	42251	355
37272	225	37660	306	38909	284	39003	296	41102	352	42252	355
37273	225	37730	53	38910	285	39005	296	41103	352	42253	355
37275	225	37731	53	38911	285	39010	296	41120	352	42255	355
37280	226	37732	53	38912	285	39012	296	41121	352	42256	355
37281	226	37733	53	38913	285	39014	296	41122	352	42257	355
37285	282	37740	53	38914	285	39020	296	41123	352	42260	355
37286	282	37741	53	38915	285	39021	296	41150	352	42261	355
37287	282	37744	53	38916	285	39045	296	41151	352	42312	291
37288	282	37745	53	38917	285	39065	296	41152	352	42312	354
37289	282	37746	53	38918	285	39090	296	41153	352	42365	222
37290	303	37747	53	38919	279	39145	296	42101	352	42366	222
37291	303	37750	53	38920	279	39165	296	42102	352	42367	222
37295	226	37751	53	38923	279	39190	296	42103	352	42368	222
37296	226	37760	53	38924	225	39192	296	42115	291	42420	291
37297	226	37761	53	38925	224	39192	323	42120	291	43050	358
37300	235	38000	298	38926	226	39193	296	42150	353	43058	358
37301	235	38001	297	38927	224	39193	323	42151	353	43060	358
37302	235	38002	298	38928	225	39194	223	42152	353	43068	358
37303	235	38003	298	38929	225	39195	223	42153	353	43071	358
37308	236	38004	299	38930	226	39196	223	42155	353	43072	358
37309	236	38005	299	38931	224	39197	223	42156	353	43077	358
37310	235	38006	298	38932	224	39198	223	42157	353	43082	358
37311	235	38007	298	38933	226	39199	223	42158	353	43083	358
37317	313	38008	298	38934	225	39200	223	42160	353	43084	358
37320	235	38009	298	38935	226	39201	223	42161	353	43086	358
37321	235	38010	298	38937	226	39202	223	42162	353	43087	359
37325	234	38012	297	38939	226	39203	223	42163	353	43089	359
37326	234	38013	297	38940	226	39204	223	42170	354	43090	359
37328	234	38014	299	38941	226	39205	223	42171	354	43094	359
37330	234	38014	299	38942	225	39206	290	42172	354	43097	358
37331	234	38015	299	38943	226	39207	290	42173	354	43098	359
37332	234	38016	299	38944	224	39208	290	42174	354	43099	359
37340	236	38017	299	38945	224	39210	290	42175	353	43300	347
37341	236	38018	299	38946	224	39212	290	42176	353	43301	347
37342	236	38020	298	38947	224	39214	290	42177	353	44041	322
37343	236	38021	299	38948	224	39216	290	42178	353	44042	322

LIST OF ITEMS



number of item	page	number of item	page	number of item	page	number of item	page	number of item	page	number of item	page
44043	322	45034	319	45099	310	45178	333	45268	335	45391	324
44050	322	45035	318	45100	334	45179	331	45269	335	45392	324
44053	319	45036	322	45101	334	45180	327	45270	39	45393	324
44950	131	45038	319	45102	334	45181	327	45271	39	45394	324
44950	315	45039	319	45104	334	45182	333	45280	334	45395	324
44955	319	45040	319	45105	334	45183	333	45283	334	45396	325
44960	323	45041	319	45106	334	45184	331	45285	334	45397	325
44965	338	45042	319	45107	334	45185	331	45286	334	45398	325
44970	313	45043	323	45108	334	45186	331	45287	334	45399	325
44971	313	45044	322	45110	326	45187	332	45289	329	45400	325
44972	310	45045	136	45111	327	45190	332	45290	329	45401	325
44980	310	45045	320	45112	327	45191	332	45291	329	45450	357
44980	310	45046	136	45113	327	45192	332	45292	329	45451	357
44980	311	45046	320	45114	327	45193	332	45293	329	45452	357
44981	310	45047	323	45115	327	45194	332	45294	328	45453	357
44981	310	45048	136	45116	326	45195	332	45295	328	45460	357
44981	311	45048	312	45117	326	45196	332	45296	328	45461	357
44981	311	45048	320	45118	326	45197	332	45297	328	45462	357
44982	310	45049	322	45120	327	45198	332	45298	328	45463	357
44982	310	45050	338	45122	327	45199	332	45299	328	45465	357
44982	311	45051	338	45123	326	45200	332	45300	333	45466	357
44983	310	45052	338	45124	326	45203	332	45301	333	45467	357
44983	310	45053	339	45125	326	45204	332	45320	339	45470	357
44983	311	45054	339	45126	326	45206	332	45321	339	45471	226
44984	311	45055	339	45130	329	45211	332	45323	337	45471	323
44984	312	45056	318	45131	329	45213	328	45323	348	45472	323
44984	312	45057	318	45132	329	45214	327	45325	337	45473	323
44985	311	45058	318	45133	329	45215	329	45326	337	45480	357
44985	312	45059	318	45134	330	45216	328	45326	337	45485	357
44991	311	45060	193	45135	329	45217	329	45327	337	45490	314
44992	311	45060	315	45136	329	45218	328	45328	337	45496	357
44995	314	45061	193	45137	329	45219	329	45329	337	45497	357
44996	312	45061	315	45138	328	45220	334	45330	337	45498	357
44997	312	45062	193	45139	328	45221	334	45330	350	45499	357
44998	312	45062	315	45140	328	45222	334	45331	337	45500	321
44999	313	45063	310	45141	328	45223	334	45331	350	45502	321
45000	314	45065	318	45142	328	45224	334	45341	333	45503	321
45001	314	45066	318	45143	328	45225	334	45342	333	45505	321
45002	314	45067	318	45144	329	45226	334	45343	333	45506	321
45003	314	45068	136	45145	329	45227	334	45344	333	45508	321
45005	314	45068	312	45146	330	45228	334	45345	333	45509	321
45006	314	45068	320	45147	331	45229	334	45346	333	45511	321
45007	314	45069	131	45150	331	45239	336	45347	333	45512	321
45008	314	45069	315	45151	331	45240	336	45348	333	45513	321
45009	314	45070	340	45152	330	45241	336	45349	333	45515	321
45010	312	45071	338	45153	330	45242	336	45350	333	45516	321
45011	313	45073	136	45154	330	45244	335	45351	333	45517	321
45012	313	45073	320	45155	330	45245	335	45352	333	45518	321
45014	312	45074	323	45156	331	45246	335	45353	333	45519	321
45015	313	45079	319	45158	330	45247	335	45354	333	45520	321
45016	313	45080	319	45159	331	45248	335	45370	136	45521	321
45017	311	45081	131	45160	331	45249	335	45370	320	45522	321
45018	312	45081	315	45161	331	45250	335	45372	325	45523	321
45019	312	45082	131	45162	330	45251	335	45372	333	45524	321
45020	310	45082	315	45163	330	45253	335	45373	325	45525	321
45021	312	45083	131	45164	331	45254	335	45373	333	45526	321
45023	310	45083	315	45167	330	45256	335	45374	325	45527	321
45025	313	45084	131	45168	331	45257	335	45374	333	45528	321
45026	312	45084	315	45169	331	45260	335	45375	325	45529	321
45027	313	45085	319	45170	336	45261	335	45375	333	45530	321
45029	313	45086	323	45171	336	45262	335	45376	325	45531	321
45030	193	45088	311	45172	336	45262	335	45376	333	45532	321
45030	315	45089	311	45172	336	45263	335	45377	325	45533	321
45031	193	45093	323	45173	336	45263	335	45377	333	45534	321
45031	315	45094	311	45173	336	45265	335	45385	324	45535	322
45032	193	45095	310	45174	333	45266	335	45386	324	45540	321
45032	315	45096	310	45175	332	45267	335	45388	324	45541	321
45033	193	45097	311	45176	333	45267	335	45389	324	45542	321
45033	315	45098	310	45177	333	45268	335	45390	324	45543	321

number of item	page	number of item	page	number of item	page	number of item	page	number of item	page	number of item	page
45550	321	45660	322	48094	49	50544	233	51244	227	52055	307
45551	321	45661	322	48095	49	50549	232	51245	227	52060	307
45552	321	45662	322	48096	49	50550	230	51246	227	52065	307
45553	321	45663	322	48097	49	50551	230	51247	227	52070	300
45555	322	45664	322	48410	306	50553	230	51258	227	52071	300
45556	321	45670	322	48411	306	50554	230	51259	227	52075	300
45557	321	45671	322	48415	306	50555	233	51260	227	52076	300
45558	321	45672	322	48420	306	50556	230	51261	227	52077	300
45559	321	45673	322	48452	307	50557	232	51262	227	52078	300
45560	322	48001	48	48453	307	50558	232	51264	227	52101	349
45562	321	48002	48	48454	307	50559	230	51271	227	52102	349
45563	321	48004	47	48455	307	50560	230	51272	227	52103	349
45564	321	48005	47	48456	307	50562	230	51273	227	52104	349
45565	321	48006	47	48457	307	50563	230	51274	227	52105	349
45570	354	48007	47	48719	273	50564	230	51275	227	52108	348
45571	354	48008	49	48729	269	50570	230	51276	227	52109	349
45572	354	48009	49	48730	269	50571	230	51278	227	52113	349
45573	354	48010	48	48731	269	50585	233	51280	227	52114	349
45580	354	48011	48	50030	355	50585	303	51281	227	52115	349
45600	334	48013	15	50031	355	50586	233	51282	227	52116	349
45601	334	48013	48	50032	355	50586	303	51283	227	52119	348
45602	334	48015	47	50033	355	50587	233	51284	227	52126	350
45603	334	48020	46	50035	228	50587	303	51286	227	52130	280
45604	334	48021	46	50035	355	50588	233	51287	227	52135	348
45605	334	48022	46	50036	228	50588	303	51288	227	52160	349
45606	334	48030	47	50036	355	51100	228	51300	227	52161	349
45607	334	48031	48	50037	355	51102	228	51301	227	52162	349
45608	334	48032	48	50038	355	51103	228	51302	227	52163	349
45609	334	48033	48	50040	355	51104	228	51303	227	52164	349
45610	334	48034	48	50041	355	51105	228	51304	227	52168	348
45611	334	48036	47	50042	355	51106	228	51305	227	52173	348
45612	334	48037	47	50050	222	51107	228	51306	227	52175	348
45613	334	48040	48	50050	222	51108	228	51307	227	52176	348
45614	334	48041	48	50051	222	51109	228	51308	227	52185	349
45615	334	48042	48	50052	222	51110	228	51320	227	52186	349
45616	334	48043	48	50052	222	51111	228	51321	227	52187	349
45617	334	48046	46	50100	227	51120	228	51322	227	52188	349
45618	334	48046	49	50101	227	51121	228	51323	227	52189	349
45619	334	48047	46	50102	227	51122	228	51324	227	52190	349
45620	334	48047	49	50103	227	51123	228	51325	227	52191	349
45621	334	48050	49	50104	227	51124	228	51327	227	52192	349
45622	334	48051	49	50106	227	51125	228	51341	227	52193	349
45623	334	48054	49	50108	227	51126	228	51402	228	52194	349
45624	334	48055	49	50500	233	51127	228	51403	228	52195	349
45625	334	48056	49	50503	233	51130	228	51404	228	52196	349
45626	334	48057	49	50510	230	51131	228	51405	228	52197	348
45627	334	48060	49	50511	230	51132	228	51406	228	52198	348
45628	334	48061	49	50512	230	51196	228	51407	228	52202	300
45629	334	48062	49	50513	230	51197	228	51408	228	52203	300
45630	334	48063	49	50514	230	51198	228	51410	228	52204	300
45631	334	48064	49	50518	232	51199	228	51412	228	52205	300
45632	334	48065	49	50519	232	51204	227	51413	228	52206	300
45633	334	48066	49	50520	232	51205	227	51414	228	52207	300
45634	334	48067	49	50522	232	51206	227	51415	228	52208	300
45635	334	48068	49	50524	232	51207	227	51416	228	52212	300
45636	334	48070	49	50525	232	51208	227	51417	228	52213	300
45637	334	48071	49	50526	232	51209	227	51418	228	52214	300
45638	334	48072	49	50527	233	51210	227	51420	228	52215	300
45639	334	48075	49	50529	232	51211	227	51430	228	52216	300
45650	322	48076	49	50531	233	51212	227	51431	228	52217	300
45651	322	48077	49	50532	233	51220	227	51432	228	52218	300
45652	322	48080	49	50533	232	51221	227	51433	228	52220	300
45653	322	48081	49	50535	232	51222	227	51435	228	52283	300
45654	322	48085	49	50536	232	51225	227	51436	228	52284	300
45655	322	48086	49	50537	232	51226	227	51450	228	52285	300
45656	322	48087	49	50539	232	51227	227	52011	249	52286	300
45657	322	48090	49	50540	233	51241	227	52011	303	52288	300
45658	322	48091	49	50541	233	51242	227	52030	252	52305	301
45659	322	48093	49	50542	233	51243	227	52050	307	52306	301

LIST OF ITEMS



number of item	page	number of item	page	number of item	page	number of item	page	number of item	page	number of item	page
52328	301	55356	229	61003	344	61098	345	61236	217	70025	44
52331	301	55357	229	61004	344	61098	351	61240	197	70026	44
52334	301	55358	229	61005	341	61111	346	61250	351	70030	44
52391	301	55359	229	61005	351	61112	346	61251	319	70031	44
52421	301	55360	229	61006	341	61114	346	61251	351	70032	44
52424	301	55361	229	61006	351	61120	346	61252	351	70033	44
52428	301	55362	229	61007	341	61121	346	61253	351	70035	44
52456	301	55400	356	61008	341	61130	338	61254	351	70036	44
52471	301	55401	356	61009	345	61131	338	61255	351	70037	44
52600	302	55402	356	61010	341	61132	339	61256	351	70040	43
52601	302	55403	356	61012	345	61133	339	61290	346	70060	44
52602	302	55404	356	61013	344	61134	339	61291	346	70061	44
52605	302	55405	356	61014	345	61135	339	61292	346	70062	44
52610	302	55406	356	61015	341	61141	339	61293	346	70063	44
52611	248	55420	356	61018	345	61142	340	61294	318	70064	43
52612	248	55421	356	61019	344	61143	340	61295	318	70065	44
52620	302	55422	356	61020	342	61144	340	61296	318	70066	43
52625	302	55423	356	61021	342	61145	340	61297	318	70070	44
52630	302	55424	356	61022	343	61146	340	61299	356	70075	44
52635	302	55425	356	61024	343	61150	338	61300	356	70090	45
52640	302	55429	356	61025	342	61155	341	61301	356	70091	45
52645	302	55430	356	61026	342	61156	341	61302	356	70092	45
52652	302	55431	356	61027	343	61157	341	61320	197	70093	45
52656	302	55432	356	61028	345	61158	341	61321	197	70094	45
52662	302	55433	356	61029	341	61161	344	61322	197	70095	45
52666	302	55436	356	61030	340	61162	344	61323	197	70096	45
52671	302	55437	356	61031	340	61163	344	61324	197	70098	210
52694	302	55450	356	61032	340	61164	345	61325	197	81011	361
52695	302	55452	356	61033	340	61165	345	61326	197	81012	361
54008	303	55453	356	61034	340	61166	345	61327	197	81013	361
55040	229	55454	356	61035	346	61169	251	61328	197	81014	361
55050	229	55455	356	61036	346	61171	350	61329	197	81015	361
55051	229	55456	356	61038	346	61172	348	61330	197	81016	361
55060	229	55457	356	61040	346	61172	350	61331	197	81022	361
55080	229	55460	356	61042	346	61173	350	61340	317	81023	361
55100	229	55461	356	61044	345	61174	350	61341	317	81024	361
55120	229	55462	356	61045	340	61175	350	61342	317	81025	361
55140	229	55465	356	61046	340	61176	350	61343	317	81035	361
55160	229	55640	229	61047	340	61177	350	61344	317	81036	361
55180	229	55642	229	61048	340	61183	351	61345	317	81053	364
55181	229	55645	229	61050	342	61184	351	61346	317	81054	364
55200	229	55650	229	61050	351	61189	351	65062	307	81057	364
55201	229	60001	347	61051	342	61190	351	65063	307	81070	364
55220	229	60006	347	61051	351	61192	350	65064	307	81071	364
55221	229	60008	347	61052	343	61193	350	65065	307	81077	364
55240	229	60012	347	61052	351	61194	350	69900	294	81100	364
55300	229	60018	347	61053	343	61195	351	69901	294	81101	364
55315	229	60019	347	61054	343	61200	350	69902	294	81102	364
55316	229	60020	347	61056	342	61201	347	69903	294	81103	364
55317	229	60022	347	61057	342	61201	350	69904	295	81104	364
55318	229	60100	251	61058	343	61202	350	69905	294	81105	364
55319	229	60115	273	61059	343	61203	345	69906	294	81106	364
55331	229	60116	273	61060	340	61204	351	69907	295	81150	362
55332	229	60117	273	61061	340	61205	351	69908	295	81151	362
55333	229	60118	273	61062	340	61207	351	69909	295	81152	362
55334	229	60121	273	61063	340	61208	350	69910	295	81155	362
55335	229	60123	273	61067	346	61209	345	69911	295	81160	362
55336	229	60125	272	61068	346	61215	351	69912	295	81165	362
55337	229	60130	272	61069	346	61218	251	69914	294	81170	362
55339	229	60132	272	61070	346	61219	351	69917	295	81175	362
55340	229	60155	272	61077	351	61221	318	69918	294	81178	362
55341	229	60157	272	61079	351	61221	318	69919	294	81180	362
55342	229	60201	347	61079	351	61221	318	69920	295	81185	362
55350	229	60206	347	61085	319	61221	318	69923	295	81186	362
55351	229	60208	347	61088	342	61222	345	69928	295	81188	362
55352	229	60212	347	61089	342	61223	344	69930	296	81189	362
55353	229	61000	342	61090	343	61224	346	69931	296	81190	362
55354	229	61001	342	61097	344	61224	346	70020	44	81191	362
55355	229	61002	343	61097	351	61230	351	70021	44	81195	361

number of item	page	number of item	page	number of item	page	number of item	page	number of item	page	number of item	page
81196	361	81267	363	81337	363	81408	363	82103	307		
81197	361	81268	363	81338	363	81409	363	82104	307		
81200	363	81269	363	81339	363	81410	363	89775	51		
81201	363	81270	363	81340	363	81411	363	89970	51		
81202	363	81271	363	81341	363	81412	363	89973	51		
81203	363	81272	363	81342	363	81413	363	89975	51		
81204	363	81273	363	81343	363	81414	363	89980	51		
81205	363	81274	363	81344	363	81415	363	89985	51		
81206	363	81275	363	81345	363	81416	363	89987	51		
81207	363	81276	363	81346	363	81417	363	89988	51		
81208	363	81277	363	81347	363	81418	363	89989	51		
81209	363	81278	363	81348	363	81419	363	89990	51		
81210	363	81279	363	81349	363	81420	363	90070	278		
81211	363	81280	363	81350	363	81421	363	90071	278		
81212	363	81281	363	81351	363	81422	363	90072	278		
81213	363	81282	363	81352	363	81423	363	90191	56		
81214	363	81284	363	81353	363	81424	363	90192	57		
81215	363	81285	363	81354	363	81425	363	18610A	150		
81216	363	81286	363	81355	363	81426	363	18611A	150		
81217	363	81287	363	81356	363	81427	363	18612A	150		
81218	363	81288	363	81357	363	81428	363	18613A	150		
81219	363	81289	363	81358	363	81429	363	18614A	150		
81220	363	81290	363	81359	363	81430	363	18615A	150		
81221	363	81291	363	81360	363	81431	363	18632A	147		
81222	363	81292	363	81361	363	81432	363	18633A	147		
81223	363	81293	363	81362	363	81433	363	18636A	147		
81224	363	81294	363	81363	363	81434	363	18637A	147		
81225	363	81295	363	81364	363	81435	363	18638A	147		
81226	363	81296	363	81365	363	81436	363	18827A	147		
81227	363	81297	363	81366	363	81437	363	18828A	147		
81228	363	81298	363	81367	363	81438	363	18830A	147		
81229	363	81299	363	81370	363	81439	363	18831A	147		
81230	363	81300	363	81371	363	81440	363	81011A	361		
81231	363	81301	363	81372	363	81441	363	81011F	361		
81232	363	81302	363	81373	363	81442	363	81011G	361		
81233	363	81303	363	81374	363	81443	363	81011H	361		
81234	363	81304	363	81375	363	81444	363	81011R	361		
81235	363	81305	363	81376	363	81445	363	M90203	365		
81236	363	81306	363	81377	363	81447	363	M90204	365		
81237	363	81307	363	81378	363	81448	363	M90205	365		
81238	363	81308	363	81379	363	81449	363	M90206	365		
81239	363	81309	363	81380	363	81450	363	M90207	365		
81240	363	81310	363	81381	363	81451	363	M90210	365		
81241	363	81311	363	81382	363	81452	363	M90220	365		
81242	363	81312	363	81383	363	81453	363	M90221	365		
81243	363	81313	363	81384	363	81454	363	M90222	365		
81244	363	81314	363	81385	363	81455	363	M90400	365		
81245	363	81315	363	81386	363	81456	363	M90403	365		
81246	363	81316	363	81387	363	81457	363	M90519	365		
81247	363	81317	363	81388	363	81458	363				
81248	363	81318	363	81389	363	81459	363				
81249	363	81319	363	81390	363	81460	363				
81250	363	81320	363	81391	363	81461	363				
81251	363	81321	363	81392	363	81462	363				
81252	363	81322	363	81393	363	81463	363				
81253	363	81323	363	81394	363	81466	363				
81254	363	81324	363	81395	363	81467	363				
81255	363	81325	363	81396	363	81468	363				
81256	363	81326	363	81397	363	81469	363				
81257	363	81327	363	81398	363	81470	363				
81258	363	81328	363	81399	363	81471	363				
81259	363	81329	363	81400	363	81472	363				
81260	363	81330	363	81401	363	81473	363				
81261	363	81331	363	81402	363	81486	363				
81262	363	81332	363	81403	363	81600	364				
81263	363	81333	363	81404	363	81603	364				
81264	363	81334	363	81405	363	82100	307				
81265	363	81335	363	81406	363	82101	307				
81266	363	81336	363	81407	363	82102	307				

GRAPHIC SYMBOLS USED IN CATALOG

PRODUCT SPECIFICATIONS USED ICONS



APPLICATION SPECIFICATIONS ·

- wood ·
- ceramics ·
- plastic ·
- aluminium · **ALU**
- copper · **Cu**
- stone ·
- glass ·
- masonry ·
- paper ·
- steel ·
- composite ·
- tiles ·
- stainless steel · **INOX**
- plaster ·
- wood with screw, nails ·
- drywall · **DRYWALL**
- for drilling in materials with tensile strength up to ... · **900 MPa**

- S2** · functional parts made of high-alloy tool steels S2
- HSS** · functional parts made of high-speed steel
- Cr-Mo** · functional parts from chrome-molybdenum steel
- CrV** · functional parts from chrome-vanadium steel
- INOX** · functional parts from stainless steel
- NYLON** · nylon handle
- TEFLON** · teflon surface
- Zn** · zinc coated surface
- TiN** · titanium nitride coated surface
- HRC 58-61** · the hardness of the functional parts material (Rockwell)
- 40% PES** · material composition - contains 40% of polyester
- PES** · material composition - made of polyester
- diamond grains on the surface of functional parts
- magnetic

- SDS+** **SDS MAX** **M14** · mounting type
- 72T** **36T** · number of ratchet teeth
- 1/2"** **3/4"** **1/4"** · mounting size
- 27 dB** · information about hearing protection
- DIN 3113** **IP 54** · complies with this standard
- 32x** · set contains this number of products
- II. class** **III. class** · complies with the specified accuracy class
- suitable for cold weather
- ERGO HANDLE** · ergonomic handle
- HOBBY** · for hobby use
- 2x AAA** · number and type of batteries
- UV STABLE** · UV stable
- RUBBER ENDS** · crashproof rubber ends



PACKAGING INFORMATION

- packed in a box
- packed with euroslot
- MOQ 12** · minimum order quantity
- 5** · no. of pieces in the package

WATERING PRODUCTS SPECIFICATIONS ·

- adjustable spray patterns ·
- minimum and maximum pressure · **2bar min** **4bar max**
- maximum water flow · **Max** **27L/min**
- irrigated area · **318 m²**
- adaptor thread size · **1/2"**
- hose diameter for connector · **1/2"**



20

25

26

FESTA

PROFESSIONAL X TOOLS



festatools



#festatools



festatools

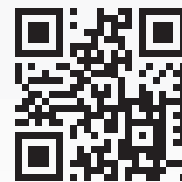

www.festa.tools

HORIZONT.

FESTA
POWER X TOOLS

FESTA
AQUATIC

ROSA KOMELON.

KDS

Stahlberg

SUPER PRO

Lescha

