



FESTA

ПРОФЕСИОНАЛНИ  АЛАТИ



20
25
—
26

FESTA
POWER X TOOLS

Električni i akumulatorski alati koriste kvalitetne komponente, najnovije tehnologije i aktuelne trendove u ovom asortimanu.

FESTA

Brend profesionalnog ručnog alata za građevinarstvo, radionice i baštu.

FESTA
INDUSTRY

Premium linija odabranih alata najvišeg kvaliteta dizajniranih za zahtevne uslove rada gde je akcenat na performansama.

FESTA
AQUATIC

Profesionalna zalivna oprema, moderni dizajn, kompatibilan sa Rosa programom

HORIZONT
MASTER

Marka vrhunskog nivoa kvaliteta

HORIZONT

Marka visokog nivoa kvaliteta i zidarskog osoblja

ROSA

Kvalitetni sistemi za zalijevanje i vrtni alat

KDS[®]

Japanski noževi sa dugom tradicijom

KOMELON[®]

Profesional measuring tapes



Profesionalni rezači pločica



Profesionalne vrtno makaze

Lescha

Profesionalne mešalice za beton

Stahlberg

Marka svetskog proizvođača nastavaka za odvijače



Profi testere

AKUMULATORSKI I ELEKTRIČNI ALATI

2 - 53



BURGIJA, ALAT ZA SEČENJE

54 - 93



ALATI

94 - 205



RADIONICA

206 - 241



GRAĐEVINSKI ALAT

242 - 307

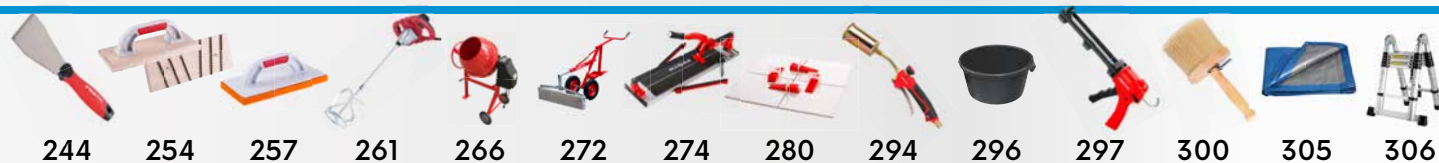

BASTENSKI ALAT

308 - 359



FESTA

360 - 365



POPIS ARTIKLA

366 - 380



BUŠILICA

4



ČEKIĆ BUŠILICA

9



ZABIJAC I HEFTALICA

10



UGAONA BRUSILICA

11



EKSCENTRIČNA BRUSILICA

12



KRUŽNA TESTERA

13



KOMPRESOR ZA VAZDUH

15



VIBRACION VAKUMSKI PIŠTOLJ ZA KERAMIKU

16



PIŠTOLJ ZA SILIKON

17



LED SVETLO

17



RADIO DAB+ / FM / BT

18



ČEKIĆ BUŠILICA

23



KRUŽNA TESTERA

26



UGAONA BRUSILICA

27



BRUSILICA ZA SUVE ZIDOVE

36



STAUBSAUGER

37



MEŠALICA GRAEVINSKIH SMESA

38



ČISTAČI POD VISOKIM PRITISKOM

39



REZAČI POLISTIRENA

40



INVERTER ZA ZAVARIVANJE

43



POLIFUZIONI ZAVARIVAČI

45



KOMPRESORI I PRIBOR

46



TOPOVI NA VRUĆI VAZDUH

50



GREJAČI

52



PRODUŽNI KABLOVI

53



ELEKTRIČNI ALATI

2 - 53



FESTA
POWER X TOOLS

BRUSHLESS **SHARE** **20V** *Li-ion technology*

brzina
0-550 min⁻¹
0-2000 min⁻¹

masa
sa baterijom 2,0 Ah **1,8**
kg
sa baterijom 4,0 Ah **2,1**
kg

obrtni moment
80 Nm

chuck
2 - 13 mm



Set sadrži:
- čekić Bušilica
- 2.0 Ah baterija
- 4.0 Ah baterija
- 2.4 A punjač
- dodatna ručka
- kofer



FESTA
POWER X TOOLS

ČEKIĆ BUŠILICA BEŽIČNI



Br. 28000
specifikacija



BRUSHLESS SHARE 20V Li-ion technology

brzina
0-550 min⁻¹
0-2000 min⁻¹

masa sa baterijom 2,0 Ah
1,8 kg

masa sa baterijom 4,0 Ah
2,1 kg

obrtni moment
80 Nm

chuck
2 - 13 mm

- Set sadrži:
- čekić Bušilica
 - 2.0 Ah baterija
 - 2.4 A punjač
 - dodatna ručka
 - kofer



izbor režima
izbor obrtni moment sile

dodatna ručka

prekidač za brzinu

brzo oslobađanje stezna glava

prekidač smera rotacije

ergonomska gumirana ručka za udoban i siguran hvat

kuka za kačenje

LED osvetljenje

baterija lock



ČEKIĆ BUŠILICA BEŽIČNI

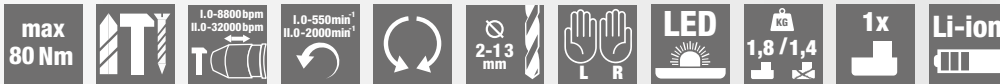

Br. specifikacija
28001

2

BRUSHLESS SHARE 20V

brzina
0-550 min⁻¹
0-2000 min⁻¹

masa bez baterija
1,4 kg

obrtni moment
80 Nm

chuck
2 - 13 mm

Preporučeni pribor

SHARE 20V Li-ion technology

- baterija* 2 Ah - 28080
- baterija* 4 Ah - 28081
- baterija* 8 Ah - 28083
- punjač* 2,4 A - 28085
- punjač* 4,0 A - 28086



izbor režima
izbor obrtni moment sile

dodatna ručka

prekidač za brzinu

brzo oslobađanje chuck head

pravac rotacionog prekidača

ergonomska gumirana ručka za udoban i siguran hvat

LED osvetljenje

kuka za kačenje



ČEKIĆ BUŠILICA BEŽIČNI



*baterija nije uključena

Br. specifikacija
28002

5

SHARE
20VLi-ion
technology

brzina
0-500 min⁻¹
0-1800 min⁻¹

masa
sa baterijom
2,0 Ah
1,7 kg

obrtni moment
45 Nm

chuck
2 - 13 mm

Set sadrži:

- čekić Bušilica
- 2x 2.0 Ah Baterija
- 2.4 A punjač
- kofer
- nosač i bitovi:
- ⊖ S5, S6 x 25 mm
- ⊕ PH1, PH2 x 25 mm
- ✳ PZ1, PZ2 x 25 mm
- HSS bušilice
2-2.5-3-4-5-6 mm



izbor režima
izbor obrtni moment sile

brzo
oslobađanje
chuck head

prekidač za brzinu

smer rotacije

ergonomska gumirana ručka
za udoban i siguran hvat

LED osvetljenje

baterija lock

kuka za kačenje

FESTA
POWER X TOOLS

ČEKIĆ BUŠILICA BEŽIČNI



Br. specifikacija

28003

3

SHARE
20V

brzina
0-550 min⁻¹
0-2000 min⁻¹

masa
bez baterija
1,4 kg

obrtni moment
45 Nm

chuck
2 - 13 mm

Preporučeni pribor

SHARE
20V
Li-ion
technology

baterija*

2 Ah - 28080

4 Ah - 28081

8 Ah - 28083

punjač*

2,4 A - 28085

4,0 A - 28086



izbor režima
izbor obrtni moment sile

brzo
oslobađanje
chuck head

prekidač za brzinu

smer rotacije

ergonomska gumirana ručka
za udoban i siguran hvat

LED osvetljenje

kuka za kačenje

FESTA
POWER X TOOLS

ČEKIĆ BUŠILICA BEŽIČNI



*baterija nije uključena

Br. specifikacija

28004



5

SHARE
20V *Li-ion*
technology

brzina
0-350 min⁻¹
0-1300 min⁻¹

masa
sa baterijom
2,0 Ah
1,3 kg

obrtni moment
28 Nm

chuck
1 - 10 mm

Set sadrži:

- čekić Bušilica
- 2x 2.0 Ah Baterija
- 2.4 A punjač
- kofer
- nosač i bitovi:
- ⊖ S5, S6 x 25 mm
- ⊕ PH1, PH2 x 25 mm
- ⊕ PZ1, PZ2 x 25 mm
- HSS bušilice
1,5-2,5-3-4-5-6 mm



izbor režima
izbor obrtni moment sile

brzo
oslobađanje
chuck head

prekidač za brzinu

prekidač
smera rotacije

ergonomska gumirana ručka
za udoban i siguran hvat

LED osvetljenje

kuka za kačenje

baterija lock



BUŠILICA AKUMULATORSKI ODVIJAČ



Br. specifikacija
28005

3

SHARE
20V

brzina
0-350 min⁻¹
0-1300 min⁻¹

masa
bez baterija
0,9 kg

obrtni moment
28 Nm

chuck
1 - 10 mm

izbor režima
izbor obrtni moment sile

brzo
oslobađanje
chuck head

prekidač za brzinu

prekidač
smera rotacije

ergonomska gumirana ručka
za udoban i siguran hvat

LED osvetljenje

kuka za kačenje



SHARE
20V *Li-ion*
technology

Preporučeni pribor

- baterija*
2 Ah - 28080
4 Ah - 28081
8 Ah - 28083
- punjač*
2,4 A - 28085
4,0 A - 28086



BUŠILICA AKUMULATORSKI ODVIJAČ



*baterija nije uključena

Br. specifikacija
28006



5

Li-ion
technology

brzina
0-350 min⁻¹
0-1300 min⁻¹

masa
sa baterijom 1,5 Ah
1 kg

obrtni moment
20 Nm

chuck
1 - 10 mm

Set sadrži:

- čekić Bušilica
- 2x Baterija 12 V | 1.5 Ah
- punjač 12 V | 2.4 A
- kofer
- svrdla i bity:
- ⊖ S5, S6 x 25 mm
- ⊕ PH1, PH2 x 25 mm
- ⊕ PZ1, PZ2 x 25 mm
- bušilice HSS
1,5-2,5-3-4-5-6 mm



izbor režima
izbor obrtni moment sile

brzo oslobađanje
chuck head

prekidač za brzinu

LED osvetljenje

indikator napunjenosti
baterije

smer rotacije

ergonomska gumirana ručka
za udoban i siguran hvat

baterija

**FESTA**
POWER X TOOLS

BUŠILICA AKUMULATORSKI ODVIJAČ

Br. 28007
specifikacija**Li-ion**
technology

brzina
bez tereta
200 min⁻¹

masa
sa baterijom 1,5 Ah
0,4 kg

maximum obrtni
moment
3 Nm

nosač alata
1/4" heksagon

Set sadrži:

- odvijlač
- punjač 5 V | 0,5 A
- bit:
- ⊖ S5 x 50 mm
- ⊕ PH1 x 50 mm
- ⊕ PH2 x 50 mm
- ⊕ H5 x 50 mm
- ⊕ T20 x 50 mm

1/4 „brzo otpuštajuća
glava sa osiguračem

podešavanja obrtni
moment

indikator punjenja baterije

zaključavanje podešavanja
položaj ručke

LED osvetljenje

prekidač smer
rotacije

ergonomske gumirani
ručka za udoban
i siguran zahvat



LED osvetljenje

FESTA
POWER X TOOLS

AKUMULATORSKI ODVIJAČ

Br. 28008
specifikacija

**SHARE
20V**

brzina
bez tereta
0-2000 min⁻¹

masa
bez baterija
1,2 kg

obrti moment
150 Nm

broj
od moždanih
udara
0-3000 bpm

1/4 „brzo otpuštajuća
glava sa osiguračem



izbor smer rotacije



ergonomski gumirani
ručka za udoban i siguran
hvat

LED osvetljenje

kuka za kačenje

Preporučeni pribor

**SHARE
20V
Li-ion
technology**

baterija*	2 Ah - 28080	
	4 Ah - 28081	
	8 Ah - 28083	
punjač*	2,4 A - 28085	
	4,0 A - 28086	



AKUMULATORSKI UDARNI KLJUČ

max 150 Nm	0-2000min ⁻¹	0-3000bpm	1/4"			LED	KG 1,2
----------------------	-------------------------	-----------	------	--	--	-----	-----------

*baterija nije uključena

Br. specifikacija
28021



**SHARE
20V**

brzina
bez tereta
**I.0-300 min⁻¹
II.0-1000 min⁻¹**

masa
bez baterija
1,7 kg

broj pogodaka
0-5000 bpm

stezna
glava
SDS+

graničnik
dubine

SDS stezanje
glava alata

prebacivanje režima rada
(sa / bez udaraljki)



prekidač za brzinu

pravac
rotacije
prekidač



**SHARE
20V
Li-ion
technology**

Preporučeni pribor

baterija*	2 Ah - 28080	
	4 Ah - 28081	
	8 Ah - 28083	
punjač*	2,4 A - 28085	
	4,0 A - 28086	



BEŽIČNI ČEKIĆ BUŠILICA

	1.0-300 min ⁻¹ II.0-1000 min ⁻¹	0-5000 bpm	1,2J		SDS+		KG 1,7
---	--	------------	------	---	------	---	-----------

*baterija nije uključena

Br. specifikacija
28025



MAX Ø
beton - Ø 20 mm
metali - Ø 10 mm
drvo - Ø 20 mm



SHARE
20V

frekvencija pucanje
60-100 min⁻¹

maksimalna dužina ekseri / spajalice
30 mm
tvrdih materijala

maksimalna dužina ekseri / spajalice
50 mm
mekih materijala

masa bez baterija
2,7 kg



SHARE
20V
Li-ion technology

Preporučeni pribor

- baterija* 2 Ah - 28080
- 4 Ah - 28081
- 8 Ah - 28083
- punjač* 2,4 A - 28085
- 4,0 A - 28086

Nails

- 23930** Zabijanje noktiju 30 mm, 2000 pcs
- 23931** Zabijanje noktiju 40 mm, 2000 pcs
- 23932** Zabijanje noktiju 50 mm, 2000 pcs

Kopča

- 23935** Klip za nokte 30 mm, 2000 pcs
- 23936** Klip za nokte 40 mm, 2000 pcs

Odgovarajuće vrste eksera i spajalica::

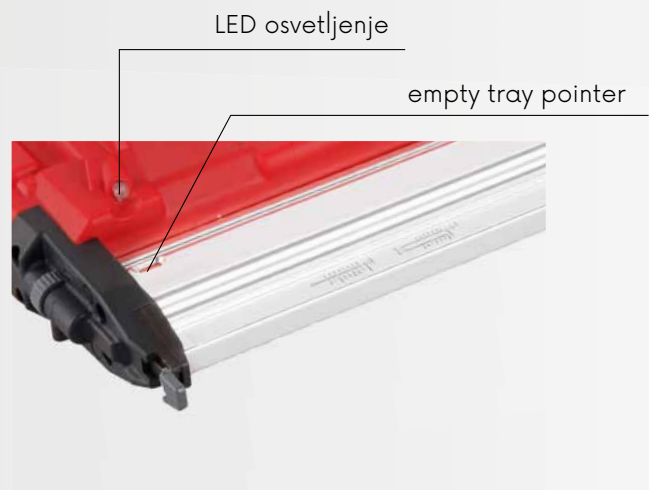
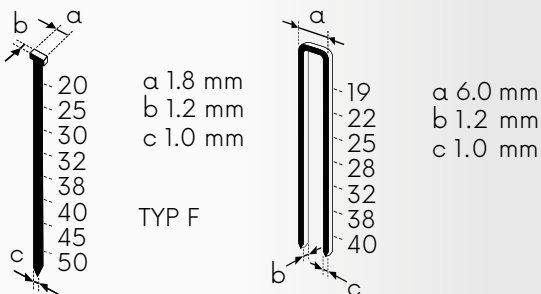

AKUMULATORSKI ZABIJAČ I HEFTALICA

max 60 min⁻¹

TYPE F

LED

2,7 KG

*baterija nije uključena

Br. 28070 specifikacija



BRUSHLESS SHARE 20V

brzina bez tereta
8500 min⁻¹

masa bez baterija
1,6 kg

maksimalna debljina rezani materijal
15 mm

maksimalan prečnik točka
125 mm

SHARE 20V
Li-ion technology

Preporučeni pribor

baterija* 2 Ah - 28080
4 Ah - 28081
8 Ah - 28083

punjač* 2,4 A - 28085
4,0 A - 28086



FESTA
POWER X TOOLS

AKUMULATORSKA UGAONA BRUSILICA



*baterija i disk nisu uključeni

Br. specifikacija

28030



4

otvori motora

ergonomska gumirana ručka za udoban i siguran hvat

zaključavanje rotacije

osigurač radni prekidač

brzo oslobađanje mehanizam zaštitni poklopac

matice za stezanje točkova



SHARE 20V

brzina bez tereta
8000 min⁻¹

masa bez baterija
1,6 kg

maksimalna debljina rezani materijal
15 mm

maksimalan prečnik točka
125 mm

SHARE 20V
Li-ion technology

Preporučeni pribor

baterija* 2 Ah - 28080
4 Ah - 28081
8 Ah - 28083

punjač* 2,4 A - 28085
4,0 A - 28086



FESTA
POWER X TOOLS

AKUMULATORSKA UGAONA BRUSILICA



*baterija i disk nisu uključeni

Br. specifikacija

28032



4

ergonomska gumirana ručka za udoban i siguran hvat

zaključavanje rotacije

osigurač radni prekidač

brzo oslobađanje mehanizam zaštitni poklopac

matice za stezanje točkova



SHARE 20V

brzina
bez tereta
10000 min⁻¹

masa
bez baterija
1 kg

ekscentričnost
točkovi
5 mm

prečnika
točkovi
125 mm



SHARE 20V Li-ion technology

Preporučeni pribor

2 Ah - 28080

baterija* 4 Ah - 28081

8 Ah - 28083

punjač*

2,4 A - 28085

4,0 A - 28086

FESTA
POWER X TOOLS

EKSCENTRIČNA BRUSILICA



*baterija nije uključena

Br. 28040
specifikacija



4

SHARE 20V

broj
oscilacije
bez opterećenja
5000-15000 min⁻¹

masa
bez baterija
1 kg

kontrola brzine



SHARE 20V Li-ion technology

Preporučeni pribor

2 Ah - 28080

baterija* 4 Ah - 28081

8 Ah - 28083

2,4 A - 28085

punjač* 4,0 A - 28086

FESTA
POWER X TOOLS

VIŠENAMENSKI BEŽIČNI UREĐAJ



*baterija nije uključena

Br. 28045
specifikacija



4

SHARE
20V



brzina bez opterećenja **3650 min⁻¹**

podesivi ugao nagiba od reza **45-90 stepeni**



maksimalni rez **50 mm**
* pod uglom od 90 stepeni ø165 mm

mak. prečnika točkovi **165 mm** (ø16 mm)



SHARE
20V
Li-ion
technology

Preporučeni pribor

baterija*	2 Ah - 28080	
	4 Ah - 28081	
	8 Ah - 28083	
punjač*	2,4 A - 28085	
	4,0 A - 28086	

FESTA
POWER X TOOLS

AKUMULATORSKA KRUŽNA TESTERA

Set sadrži:

- kružna testera
- bočni vodič
- ključ
- list testere ø 165 x 2,8/2,0 x 20 mm 24T (**22314**)



Br. specifikacija

28035



SHARE 20V

broj udaraca
sečiva

0-2400 min⁻¹

masa
bez baterija
1,8 kg

mak. ugao
bevel cut
45 stepeni

mak. rezati
profil
čelik: 6 mm
drvo: 80 mm

Preporučeni pribor

2 Ah - 28080

baterija* 4 Ah - 28081

8 Ah - 28083

2,4 A - 28085

punjač* 4,0 A - 28086

SHARE
20V
Li-ion
technology

FESTA
POWER X TOOLS

AKUMULATORSKA UBODNA TESTERA



*baterija nije uključena

Br. 28050
specifikacija



4

ergonomska gumirana ručka
za udoban i siguran hvat

osigurač
radni prekidač

predoscilacija
podešavanje

LED

zaključavanje
šipke

vodica

baza

pav
zaključavanje
nagiba

zakošeni rez

0°
45° 45°

SHARE 20V

broj
oscilacije bez
opterećenja
0-3000 min⁻¹

masa
bez baterija
1,7 kg

mak. debljina rezanja

Drvo: 100 mm

Čelik: 5 mm

aluminijum/
bakar: 20 mm

Preporučeni pribor

2 Ah - 28080

baterija* 4 Ah - 28081

8 Ah - 28083

2,4 A - 28085

punjač* 4,0 A - 28086

SHARE
20V
Li-ion
technology

FESTA
POWER X TOOLS

AKUMULATORSKA KLIPNA TESTERA



*baterija nije uključena

Br. 28055
specifikacija



4

osigurač
radni prekidač

ergonomska gumirana ručka
za udoban i siguran hvat

brzo
oslobađanje
testere

SHARE
20V

mak. pritisak
8,2 bar

manometar
psi, bar,
kgf/cm², kPa

crevo
600 mm

napon
20 V

displej manometra
sa pozadinskim
osvetljenjem



ergonomska
gumirana ručka
za udoban
i siguran hvat

adapter za
automobilsku
bateriju 3 m

Brza spojnica



- Set sadrži:
- kompresor
 - adapter za napajanje iz akumulatora automobila
 - 3k adaptera za naduvavanje

crevo
Ø 10,5 x 600 mm

LED svetlo



Preporučeni pribor

SHARE
20V
Li-ion
technology

- baterija*
- 2 Ah - 28080
 - 4 Ah - 28081
 - 8 Ah - 28083
- punjač*
- 2,4 A - 28085
 - 4,0 A - 28086



FESTA
POWER X TOOLS

KOMPRESOR

*baterija nije uključena

Br. specifikacija

28075

48013 **NEW** adapteri



1

1



NEW
 horizontalni položaj
 110 kg
 Ø 220 mm
 vertikalni položaj
 80 kg
 USB-C



USISNA ČAŠA AKU

Ø 220 mm	80 kg	110 kg	ROUGH SURFACE	USB-C	Li-ion 3.6V 2Ah
----------	-------	--------	---------------	-------	--------------------

Br. 36326 specifikacija



1

SHARE 20V

maksimalna nosivost
 60 kg
 težina
 3 kg
 napon
 20 V
 Regulator intenziteta vibriranja
 12 nivoa podešavanja,
 3500 - 8500 r/min

ergonomska gumirana ručka za udoban i siguran hvat



osvetljen displej



poluga za zaključavanje usisne čaše



čaha Ø 125 mm



VIBRATOR ZA PLOČICE



Preporučeni pribor

- baterija* 2 Ah - 28080
- 4 Ah - 28081
- 8 Ah - 28083
- punjač* 2,4 A - 28085
- 4,0 A - 28086

Set sadrži:

- vibrator za pločice
- baterija 2,0 Ah (samo 36328)
- punjač (samo 36328)
- slučaj



Br.	specifikacija	
36328	sa 2Ah baterijom i punjačem	1
36329	bez baterije i punjača	1



SHARE
20V

podesiva brzina
0-8,7 mm/s

težina
1,7 kg

obrotni moment
6500 N

napon
20 V



kapacitet 310 ml

okidač promenljive brzine

LED svetlo

ergonomska gumirana ručka za udoban i siguran hvat



SHARE
20V
Li-ion technology

Preporučeni pribor

- baterija* 2 Ah - 28080
- 4 Ah - 28081
- 8 Ah - 28083
- punjač* 2,4 A - 28085
- 4,0 A - 28086



PIŠTOLJ ZA ZAPTIVANJE

*baterija nije uključena

Br.	specifikacija
28060	



1



REZERVNI KERTRIDŽ ZAPTIVAČA

za 28060

Br.	specifikacija
28061	600 ml



1

SHARE
20V

temperatura boje
5000 K

masa bez baterija
0,9 kg

svetlosni fluks
2000 lm (100%)

LED napajanje
20W



SHARE
20V
Li-ion technology

Preporučeni pribor

- baterija* 2 Ah - 28080
- 4 Ah - 28081
- 8 Ah - 28083
- punjač* 2,4 A - 28085
- 4,0 A - 28086

podešavanje intenziteta svetlosti 50%, 100%



podešavanje glave za 360°



LED SVETLO AKU

20W	2000 lumen	IP20	0,9 kg
-----	------------	------	--------

*baterija nije uključena

Br.	specifikacija
28065	



2

SHARE 20V

tuner
DAB+ / FM / BT

snaga
2x 15 W

otpornost na vodu
IP54

napon
20 V



USB za punjenje 5V

SHARE
napajanje 20V



FM antenna



displej u boji

SHARE 20V Li-ion technology

Preporučeni pribor

baterija*	2 Ah - 28080	
	4 Ah - 28081	
	8 Ah - 28083	
punjač*	2,4 A - 28085	
	4,0 A - 28086	

AUX IN jack 3,5 mm



stereo zvučnici

napajanje - 230V adapter



FESTA
POWER X TOOLS

RADIO DAB+ / FM / BT

- Stereo
- DAB+ / FM
- eksterni ulaz Bluetooth V5.0 / AUX IN 3,5 mm priključak
- otpornost na prodiranje vode IP54
- 30 unapred podešenih memorija (30 za DAB / 30 za FM)
- USB za punjenje
- 2,4" ekran u boji
- snaga 2x 15 W
- 20 V / 1,3 A
- Adapter za napajanje

*baterija nije uključena

Br. specifikacija
28076



SHARE
20V



PUNJAČ 20 V I 2,4 A

Br.	specifikacija
28085	220 – 240 V, 50 – 60 Hz, 70 W



SHARE
20V



PUNJAČ 20 V I 4,0 A

Br.	specifikacija
28086	*220 – 240 V, 50 – 60 Hz, 105 W



SHARE *Li-ion technology*
20V



indikator punjenja baterije

BATERIJA 20 V I 2,0 Ah

20V	2,0 Ah	Li-ion	KG 0,4
-----	--------	--------	--------



Br.	specifikacija
28080	



SHARE *Li-ion technology*
20V



indikator punjenja baterije

BATERIJA 20 V I 4,0 Ah

20V	4,0 Ah	Li-ion	KG 0,7
-----	--------	--------	--------



Br.	specifikacija
28081	



SHARE *Li-ion technology*
20V



NEW



indikator punjenja baterije

BATERIJA 20 V I 8,0 Ah

20V	8,0 Ah	Li-ion	KG 1,0
-----	--------	--------	--------



Br.	specifikacija
28083	



SHARE
20V *Li-ion*
technology

28080



28085



SNIŽENA
CENA

FESTA
POWER X TOOLS

AKUMULATORSKI SET SA KOMPLETOM TORBA 2+3

28080 - Baterija za akumulatorske alate FESTA SHARE20V 2,0 Ah
28085 - Punjač FESTA SHARE20V 2,4 A

Br.	specifikacija	
28090		1

SHARE
20V *Li-ion*
technology

28004
strana 6



28025
strana 9



37330



28030
strana 12



BRUSHLESS

SNIŽENA
CENA
+ BESPLATNA TORBA

FESTA
POWER X TOOLS

AKUMULATORSKI SET SA KOMPLETOM TORBA 3+3

28004 - Akumulatorska bušilica sa čekićem FESTA SHARE20V
28025 - Čekić za bušenje Akumulatorski FESTA SDS+ SHARE20V
28030 - Ugaona brusilica Akumulatorska FESTA „BRUSHLESS“ SHARE20V 125 mm
28080 - Baterija za akumulatorske alate FESTA SHARE20V 2,0 Ah
28081 - Baterija za akumulatorske alate FESTA SHARE20V 4,0 Ah
28086 - Punjač FESTA SHARE20V 4,0 A

28080 strana 18		
28081 strana 18		
28086 strana 18		

Br.	specifikacija	
28102		1

BRUSHLESS **SHARE**
20V *Li-ion*
technology

28002
strana 5



37330



28030
strana 12



SNIŽENA
CENA
+ BESPLATNA TORBA

FESTA
POWER X TOOLS

AKUMULATORSKI SET SA KOMPLETOM TORBA 2+3

28002 - Akumulatorska bušilica sa čekićem FESTA SHARE20V
28030 - Ugaona brusilica Akumulatorska FESTA „BRUSHLESS“ SHARE20V 125 mm
28080 - Baterija za akumulatorske alate FESTA SHARE20V 2,0 Ah
28081 - Baterija za akumulatorske alate FESTA SHARE20V 4,0 Ah
28086 - Punjač FESTA SHARE20V 4,0 A

28080 strana 18		
28081 strana 18		
28086 strana 18		

Br.	specifikacija	
28103		1

SHARE
20V

Li-ion
technology

28004
strana 6

28032
strana 12

28055
strana 15

28035
strana 14

37330

28040
strana 13

SNIŽENA
CENA
+ BESPLATNA TORBA

FESTA
POWER X TOOLS

AKUMULATORSKI SET SA KOMPLETOM TORBA 5+3

- 28004 - Akumulatorska bušilica sa čekićem FESTA SHARE20V
- 28032 - Ugaona brusilica Akumulatorska FESTA SHARE20V 115 mm
- 28035 - Kružna testera Akumulatorska FESTA SHARE20V 165 mm/d 16 mm
- 28040 - Ekscentrična brusilica Akumulatorska FESTA SHARE20V 125 mm 8 otv.
- 28055 - Hack testera Akumulatorska FESTA SHARE20V
- 28080 - Baterija za akumulatorske alate FESTA SHARE20V 2,0 Ah
- 28081 - Baterija za akumulatorske alate FESTA SHARE20V 4,0 Ah
- 28086 - Punjač FESTA SHARE20V 4,0 A



28080
strana 18



28081
strana 18



28086
strana 18



Br. specifikacija

28101



1

SHARE
20V

Li-ion
technology

BRUSHLESS

28002
strana 5

28030
strana 12

28040
strana 13

BRUSHLESS

37330

28055
strana 15

28035
strana 14

SNIŽENA
CENA
+ BESPLATNA TORBA

FESTA
POWER X TOOLS

AKUMULATORSKI SET SA KOMPLETOM TORBA 5+3

- 28002 - Akumulatorska bušilica sa čekićem FESTA SHARE20V
- 28030 - Ugaona brusilica Akumulatorska FESTA „BRUSHLESS“ SHARE20V 125 mm
- 28035 - Kružna testera Akumulatorska FESTA SHARE20V 165 mm/d 16 mm
- 28040 - Ekscentrična brusilica Akumulatorska FESTA SHARE20V 125 mm 8 otv.
- 28055 - Hack testera Akumulatorska FESTA SHARE20V
- 28080 - Baterija za akumulatorske alate FESTA SHARE20V 2,0 Ah
- 28081 - Baterija za akumulatorske alate FESTA SHARE20V 4,0 Ah
- 28086 - Punjač FESTA SHARE20V 4,0 A

28080
strana 18



28081
strana 18



28086
strana 18



Br. specifikacija

28104



1

BRUSHLESS

alat se napaja
DC motor bez četkica

obrtni moment



brzina



pravac koji se bira
rotacije



chuck



bušenje, bušenje sa
čekićem, šrafljenje



broj udaraca u minuti



bušenje, uvrtnje šrafova



masa
sa / bez baterije



način vezivanja



način vezivanja



način vezivanja



ekscentricitet diska



upravljanje uređajem
za desnu i levu ruku



ispunjava taj standard



svetlosni fluks



usmereni ugao svetlosti



maksimalna frekvenci-
ja paljenja

**SHARE
20V**

alat je kompatibilan
sa obe Baterije

pogodne vrste noktiju



pogodne vrste kopči



točak za brušenje
sa rupama



maksimalni prečnik točka



prečnik točka



maksimalna debljina sečenja
materijal: drvo



maksimalna debljina sečenja
materijal: čelik



podešavanje predoscilovanja



dodatak za testere



broj udaraca sečiva



možućnost zakošenog
rezati



brzo otpuštanje
lista testere



broj oscilacija testere



LED osvetljenje



kapacitet baterije



baterija



vreme punjenja
baterija



NEW

brzina
520 min⁻¹

BPM / udar
0 - 4100 / 12 J

snaga
1500 W

stezna
glava
SDS MAX



MAX ø beton - ø 40 mm



graničnik dubine

sistem za smanjenje
vibracija

ergonomska
gumirana ručka
za udoban
i siguran hvat



sakupljač prašine

SDS MAX
stezna glava



dodatna ručka



3.0m

FESTA
POWER X TOOLS

ČEKIĆ BUŠILICA SDS MAX

Set sadrži:

- čekić bušilica
- bočna ručka
- graničnik dubine
- sakupljač prašine
- ključ
- plastično kućište
- rezervne ugljene četke
- dodatna oprema SDS MAX:

ø 16 x 280 mm

18 x 320 mm

rezervne ugljene
četke 2 kom - 28229



Br. 28221 specifikacija

FESTA
POWER X TOOLS



brzina
0-850 min⁻¹

BPM / udar
0-4500 / 6 J

snaga
1500 W

stezna
glava
SDS+



MAX ø
beton - ø 32 mm
metali - ø 13 mm
drvo - ø 40 mm



graničnik
dubine

sistem za smanjenje
vibracija

SDS+
stezna glava

ergonomska
gumirana ručka
za udoban
i siguran hvat

dodatna ručka



FESTA
POWER X TOOLS

ČEKIĆ BUŠILICA

Set sadrži:

- čekić bušilica
- bočna ručka
- graničnik dubine
- ključ
- plastično kućište
- rezervne ugljene četke
- dodatna oprema SDS+:

⚡ ø 8, 10, 12 x 160 mm

🔧 20 x 250 mm

📏 14 x 250 mm



rezervne ugljene
četke 2 kom - 28228



Br. specifikacija
28225



brzina
0-1350 min⁻¹

BPM / udar
0-5500 / 2,8 J

snaga
800 W

stezna
glava
SDS+
ø 2 - 13 mm



MAX ø
beton - ø 25 mm
metali - ø 13 mm
drvo - ø 30 mm

SDS+
stezna glava

mehanizam za
brzu izmenu
stezne glave

pravac
rotacije
prekidač

graničnik
dubine



ergonomska
gumirana ručka
za udoban
i siguran hvat

dodatna ručka

2.0m

SDS+

ø 2 - 13 mm

FESTA
POWER X TOOLS

ČEKIČ BUŠILICA

Set sadrži:

- čekić bušilica
- bočna ručka
- graničnik dubine
- stezna glava ø 2 - 13 mm
- plastično kućište
- vazelin
- rezervne ugljene četke
- dodatna oprema SDS+:

ø 6, 8, 10 x 160 mm

20 x 250 mm

14 x 250 mm



rezervne ugljene
četke 2 kom - 28223



Br. 28220
specifikacija

brzina
0-4500 min⁻¹

težina
4,3 kg

snaga
1400 W

mak.
prečnika točkovi
max ø 185 mm / ø 20 mm



max. 63 mm



ergonomska
gumirana ručka
za udoban
i siguran hvat



max. 45°



usisavanje prašine
ø 35 mm

2.0m

vodica
6 - 120 mm

FESTA
POWER X TOOLS

KRUŽNA TESTERA

Set sadrži:

- kružna testera
- bočni vodič
- ključ
- rezervne ugljene četke
- list testere ø 185 x 2,3/1,3 x 20 mm 24T (22316)



22316

1400W

230V
~ 50Hz

4500 min⁻¹

ø 20
1 mm

90°

45°

42mm

KG

4.3

rezervne ugljene
četke 2 kom - 28233



Br. specifikacija
28230

brzina
6600 min⁻¹

težina
5,8 kg

snaga
2400 W

maksimalan
prečnik točka
M14
max ø 230 mm



ergonomska
gumirana ručka
za udoban
i siguran hvat

SOFT START

glatko pokretanje



zaštitni poklopac

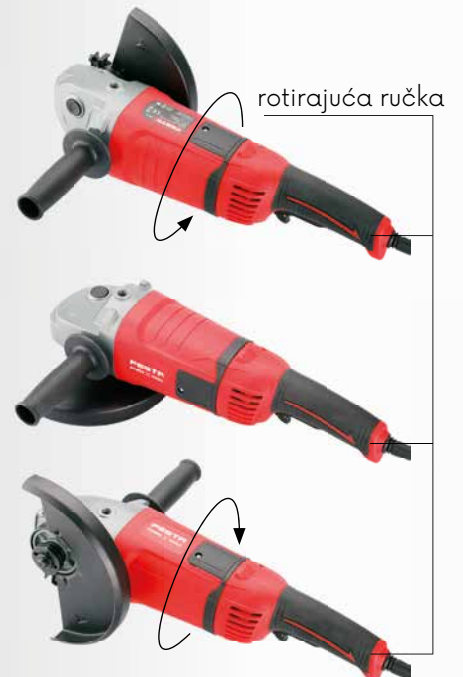

FESTA
POWER X TOOLS

UGAONA BRUSILICA

- Set sadrži:
- ugaona brusilica
 - zaštitnik
 - bočna ručka
 - ključ
 - rezervne ugljene četke



rezervne ugljene
četke 2 kom - 28218



Br. specifikacija
28215

2

brzina
11000 min⁻¹

težina
2 kg

snaga
900 W

maksimalan
prečnik točka
M14
max ø 125 mm

dodatna ručka



osigurač
radni prekidač

SOFT START
glatko pokretanje



3,0m

zaštitni poklopac

FESTA
POWER X TOOLS

UGAONA BRUSILICA

- Set sadrži:
- ugaona brusilica
 - zaštitnik
 - bočna ručka
 - ključ
 - rezervne ugljene četke



900W	230V ~ 50Hz	11000min ⁻¹	M14	max ø 125mm	2.0m RUBBER	KG 2.0	
------	----------------	------------------------	-----	----------------	----------------	-----------	--

rezervne ugljene četke 2 kom - 28213



Br. 28210
specifikacija

8

FESTA
POWER X TOOLS

REZERVNE UGLJENE ČETKE

2x



Br.	specifikacija	
28229	za 28221	1
28228	za 28225	1
28223	za 28220	1
28233	za 28230	1
28213	za 28210	1
28218	za 28215	1



ADAPTER SDS MAX / SDS+

SDS MAX → SDS+		
Br.	Specifikacija	
20744		1



ADAPTER SDS+ / 1/2" UNF

SDS+		
Br.	Specifikacija	
20745		1



FESTA

ADAPTER SDS+ NA BIT 1/4"

SDS+ → 1/4"		
Br.	Specifikacija	
20743	75 mm	20



FESTA

GLAVA ZA BUŠILICU

1/2"		
Br.	Specifikacija	
20960	1-13 mm + 2 ključe, 1/2 - 20 UNF	3
20966	Rezervno ključ	25



FESTA

GLAVA ZA BUŠILICU QUICK GRIP

1/2"		
Br.	Specifikacija	
20965	1,5 - 13 mm 1/2' - 20 UNF	1



GLAVA ZA BUŠILICU QUICK

1/2"		
Br.	Specifikacija	
20961	1,5 - 13 mm 1/2' - 20 UNF	1



ADAPTER ZA BUŠENJE 90°

Br.	Specifikacija	
20365	Ø 1 - 10 mm	10



GLAVA ZA BUŠILICU QUICK GRIP

1/4"		
Br.	Specifikacija	
20963	Ø 1 - 6 mm	10



FESTA

USISIVAČ ZA PRAŠINU

Br.	Specifikacija	
28267	max. 70 mm	1

VODJICA ZA BUŠILICE I BURGIIJE MERA

Br.	Specifikacija	
20379	Ø 4, 5, 6, 7, 8, 10, 12 mm	10

TEHNIČKI
SPECIFIKACIJE

KATALOŠKI BROJ PROIZVODA	28000	28001	28002	28003	28004
Ime	Čekić Bušilica bežični	Čekić Bušilica bežični	Čekić Bušilica bežični	Čekić Bušilica bežični	Čekić Bušilica bežični
Brzina bez tereta	I.0-550 min ⁻¹ II.0-2000 min ⁻¹	I.0-550 min ⁻¹ II.0-2000 min ⁻¹	I.0-550 min ⁻¹ II.0-2000 min ⁻¹	I.0-500 min ⁻¹ II.0-1800 min ⁻¹	I.0-500 min ⁻¹ II.0-1800 min ⁻¹
Broj pogodaka	I.0-8800min ⁻¹ II.0-32000min ⁻¹	I.0-8800min ⁻¹ II.0-32000min ⁻¹	I.0-8800min ⁻¹ II.0-32000min ⁻¹	0-19200 min ⁻¹	0-19200 min ⁻¹
Broj udaraca					
Obrtni trenutak	80 Nm	80 Nm	80 Nm	45 Nm	45 Nm
Maks. baterija napon	20V	20V	20V	20V	20V
Broj faza obrtnog momenta	20+1+1	20+1+1	20+1+1	19+1+1	19+1+1
Stezna glava	2-13 mm	2-13 mm	2-13 mm	2-13 mm	2-13 mm
Težina bez baterija	1,4kg	1,4kg	1,4kg	1,3kg	1,3kg
Cover	IPX0	IPX0	IPX0	IPX0	IPX0
Nivo zvučnog pritiska neizvesnost K	LpA=97,04dB(A) K=5dB(A)	LpA=97,04dB(A) K=5dB(A)	LpA=97,04dB(A) K=5dB(A)	LpA=79dB(A) K=5dB(A)	LpA=79dB(A) K=5dB(A)
Nivo snage zvuka neizvesnost K	LwA=86,04dB(A) K=5dB(A)	LwA=86,04dB(A) K=5dB(A)	LwA=86,04dB(A) K=5dB(A)	LwA=90dB(A) K=5dB(A)	LwA=90dB(A) K=5dB(A)
Vibracije bez udaranja u metal	$\alpha_{h,D}=3,9m/s^2$ K=1,5m/s ²	$\alpha_{h,D}=3,9m/s^2$ K=1,5m/s ²	$\alpha_{h,D}=3,9m/s^2$ K=1,5m/s ²	$\alpha_{h,D}=2,4m/s^2$ K=1,5m/s ²	$\alpha_{h,D}=2,4m/s^2$ K=1,5m/s ²
Vibracije bez udaranja u beton	$\alpha_{h,D}=11,4m/s^2$ K=1,5m/s ²	$\alpha_{h,D}=11,4m/s^2$ K=1,5m/s ²	$\alpha_{h,D}=11,4m/s^2$ K=1,5m/s ²	$\alpha_{h,D}=7,5m/s^2$ K=1,5m/s ²	$\alpha_{h,D}=7,5m/s^2$ K=1,5m/s ²
Maksimalna vibracija, nesigurnost K					
Udarne snaga					
Prečnik bušenja					
Vibracije u beton -glavna ručka					
Vibracije u betonu - dodatna ručka					
Sadržaj paketa	bušilica, 2,4 punjač, baterija 2.0 Ah, 4.0 Ah baterija, dodatna ručka, kofer	bušilica, punjač 2.4 A, baterija 2.0 Ah, dodatna ručka, kofer	bušiti	bušilica, 2,4 punjač, 2x 2.0 Ah baterija, 6x bit, nosač, 6x bušilica, kofer	bušiti



28005	28006	28007	28008	28021	28025
Bušilica akumulatorski odvijač	Bušilica akumulatorski odvijač	Bušilica akumulatorski od- vijač	Akumulatorski odvijač	Akumulatorski udarni ključ	Akumulatorski čekić Bušilica
I.0-350 min ⁻¹ II.0-1300 min ⁻¹	I.0-350 min ⁻¹ II.0-1300 min ⁻¹	I.0-350 min ⁻¹ II.0-1300 min ⁻¹	200 min ⁻¹	0-2000 min ⁻¹	I.0-300 min ⁻¹ II.0-1000 min ⁻¹
					0-5000bpm
				0-3000bpm	
28 Nm	28 Nm	20 Nm	3 Nm	150 Nm	
20V	20V	12V	3.6V	20V	20V
19+1	19+1	19+1	6+1		
1-10mm	1-10mm	1-10mm	1/4" heksagon	1/4" heksagon	SDS+
0,9kg	0,9kg	*1kg	*0,4kg	1,2kg	1,7kg
IPX0	IPX0	IPX0	IPX0	IPX0	IPX0
LpA=69dB(A) K=5dB(A)	LpA=69dB(A) K=5dB(A)	LpA=78dB(A) K=5dB(A)	LpA=58dB(A) K=3dB(A)	LpA=92dB(A) K=3dB(A)	LpA=82,98dB(A) K=3dB(A)
LwA=80dB(A) K=5dB(A)	LwA=80dB(A) K=5dB(A)	LwA=67dB(A) K=5dB(A)	LwA=69dB(A) K=3dB(A)	LwA=103dB(A) K=3dB(A)	LwA=93,98dB(A) K=3dB(A)
$\alpha_{h,D} < 1,9m/s^2$ K=1,5m/s ²	$\alpha_{h,D} < 1,9m/s^2$ K=1,5m/s ²	$\alpha_{h,D} = 2,1m/s^2$ K=1,5m/s ²			
$\alpha_{h,D} = 10,1m/s^2$ K=1,5m/s ²	$\alpha_{h,D} = 10,1m/s^2$ K=1,5m/s ²	$\alpha_{h,D} = 7,5m/s^2$ K=1,5m/s ²			
			$\alpha_h < 2,5m/s^2$ K=1,5m/s ²	$\alpha_{h,D} = 15,9m/s^2$ K=1,5m/s ²	
					1,2J
					Čelik: 10mm concrete: 20mm Drvo: 20mm
					$\alpha_{h,(HD)} = 5,582m/s^2$ K=1,5m/s ²
					$\alpha_{h,(HD)} = 5,523m/s^2$ K=1,5m/s ²
bušilica, 2.4 punjač, 2x 2.0 Ah baterija, 6x bit, nosač, 6x bušilica, kofer	bušiti	bušilica, 2.4 punjač, 2x 1.5 Ah baterija, 6x bit, nosač, 6x bušilica, kofer	šrafciher, punjač 0,5 A, 1,5 Ah baterija, 5x bit	zatezač	čekić za bušenje, dodatna ručka, SDS stezanje glava alata

* težina je navedena uključujući bateriju

TEHNIČKI
SPECIFIKACIJE

KATALOŠKI BROJ PROIZVODA	28030	28032	28035	28040
Ime	Bežični ugao brusilica	Bežični ugao brusilica	Bežični kružni Testera	Baterija orbital sander
Brzina praznog hoda	8500 min ⁻¹	8000 min ⁻¹	3650 min ⁻¹	10000 min ⁻¹
Broj oscilacija bez opterećenja				
Napred				
Broj stepeni predoscilovanja				
Broj listova lista testere				
Maksimalni profil sečenja				
Maksimalni prečnik točka	125 mm	115 mm		
Disk za podršku				125 mm
8 usisnih rupa na krugu				65 mm
Ekscentricitet točka				5 mm
Veličina navoja vretena	M14	M14		
Maksimalna debljina rezanog materijala	15 mm	15 mm		
Maks. baterija napon	20V	20V	20V	20V
Podesiv ugao sečenja			0-45°	
Isecite pod uglom od 45 °			35 mm	
Isecite pod uglom od 90 °			50 mm	
Ugao oscilacije				
Dimenzija baza za mlevenje delta				
Kontrola brzine vibracija				
Pričvršćivanje lista testere				
Hod lista testere				
Baza tanjira veličine			28 cm x 13,3 cm	
Težina bez baterija	1,6kg	1,6kg	2,7kg	1kg
Prečnik točka			165 mm	
Debljina tela točka			1,4 mm ± 5% mm	
Debljina SK sečiva			2,0 ± 5% mm	
Širina sečenja			2,3 ± 5% mm	
Prečnik otvora točka nakon stezanja			16 mm	
Broj zubaca diska			24	
Cover	IPX0	IPX0	IPX0	IPX0
Tip eksera, visina k širina k debljina				
Kopčas-raspon k visina k širina k debljina				
Maks. dužina eksera / klipova u meke prostirke.				
Maks. dužina eksera / klipova u tvrdi mat.				
Prosek / maks. frekvencija snimanja				
Vreme rada (4 AH baterija, potpuno napunjena)				
Kapacitet magazina za eksere / spajalice				
Nivo zvučnog pritiska neizvesnost K	LpA=87,1dB(A) K=3dB(A)	LpA=76,67dB(A) K=3dB(A)	LpA=84dB(A) K=3dB(A)	LpA=76dB(A) K=3dB(A)
Nivo snage zvuka neizvesnost K	LwA=98,1dB(A) K=3dB(A)	LwA=87,67dB(A) K=3dB(A)	LwA=95dB(A) K=3dB(A)	LwA=87dB(A) K=3dB(A)
Vibracije prilikom brušenja površine	$a_{h,AG}=8,363m/s^2$ K=1,5m/s ²	$a_{h,AG}=5,324m/s^2$ K=1,5m/s ²		
Vibracija za sečenje ploče				
Vibracija za sečenje lima				
Vibracija za sečenje Drvo:en ramova				
Maksimalna vibracija, nesigurnost K			$a_h < 2,5m/s^2$ K=1,5m/s ²	$a_h = 9,5m/s^2$ K=1,5m/s ²
Sadržaj paketa	brusilica, poklopac točka, dodatna ručka, ključ	brusilica, poklopac točka, dodatna ručka, ključ	Testera, graničnik dubine, testere	mlin, vreća za sakupljanje prašine



28045	28050	28055	28070
Bežični uređaj multifunkcionalni	Akumulatorska ubodna testera	Akumulatorska klipna testera	Akumulatorski zabijač i heftalica
5000-15000 min ⁻¹		0-3000 min ⁻¹	
		1°	
	3+0		
	0-2400 min ⁻¹		
	Čelik: 6mm, Drvo: 80mm	Drvo: 100 mm, Čelik: 5 mm, aluminijum / bakar: 20 mm	
20V		20V	20V
	ukošeni rez mak. 45 °		
3°			
90 mm			
Da			
univerzalan		univerzalan	
		20 mm	
1kg	1,8kg	1,7kg	2,7kg
IPX0	IPX0	IPX0	IPX0
			F, 20-50mm x 1,2mm x 1,0 mm
			6,0mm x 19-40mm x 1,2mm x 1,0mm
			50 mm
			30 mm
			60/100 min ⁻¹
			1 sat
			100 komada
LpA=78dB(A) K=3dB(A)	LpA=88,1dB(A) K=5dB(A)	LpA=87,33dB(A) K=5dB(A)	LpA=79,9dB(A) K=3dB(A)
LwA=89dB(A) K=3dB(A)	LwA=99,1dB(A) K=5dB(A)	LwA=98,33dB(A) K=5dB(A)	LwA=90,9dB(A) K=3dB(A)
	$\alpha_{h,B}=3,3m/s^2$ $K=1,5m/s^2$ $\alpha_{h,M}=4m/s^2$ $K=1,5m/s^2$	$\alpha_{h,B}=21,10m/s^2$ $K=1,5m/s^2$	
		$\alpha_{h,WB}=21,98m/s^2$ $K=1,5m/s^2$	
$\alpha_h=2,8m/s^2$ $K=1,5m/s^2$			$\alpha_h=1,39m/s^2$ $K=1,5m/s^2$
brusilica, prilozni (testera, strugač, nosač), 3x brusni papir P80	pila, Führungsschiene, usisni dodatak, 2x list testere	testera, 2x list testere	heftalica / heftalica, 200x ekseri, 200x spajalice

TEHNIČKI
SPECIFIKACIJE

KATALOŠKI BROJ PROIZVODA	28075	36328	36329	28060	28076
Ime	kompresor	vibrator za pločice	vibrator za pločice	pištolj za zaptivanje	radio AKU DAB+ / FM / BT
Manometar	psi; bar; kgf/cm ² ; kPa				
Mak. Pritisak	120 psi / 8,2 bar				
Crevo	ø 10,5 x 600 mm				
Čaša		Ø 123 mm	Ø 123 mm		
Maksimalna nosivost		60 kg	60 kg		
Regulator inteziteta vibriranja		12 nivoa podešavanja 3500 - 8500 r/min	12 nivoa podešavanja 3500 - 8500 r/min		
Obrtni moment				6500 N	
Podesiva brzina				0 - 8,7 mm/s	
Kapacitet				310 ml	
Tuner					DAB+ / FM
Eksterni ulaz					Bluetooth 5.0, aux IN jack 3,5 mm
Snaga					2 x 15 W
Ekran					ekran u boji 2,4"
Napajanje					adapter 230 V, baterija Li-ion FESTA share 20 V
Memorija					30 (DAB+), 30 (FM)
Otpornost na prodiranje vode					IPX54
Težina		3 kg	3 kg	1,7 kg	1,3kg
Napon	20 V	20 V	20 V	20 V	20 V
Sadržaj paketa	kompresor, adapter za napajanje iz akumulatora automobila, 3x adaptera za naduvavanje	vibrator za pločice, baterija 2,0 Ah, punjač, slučaj	vibrator za pločice, slučaj	pištolj za zaptivanje	radio, adapter 230 V



KATALOŠKI BROJ PROIZVODA	28221	28225	28220	28230	28210	28215
Ime	čekić bušilica SDS MAX	čekić bušilica SDS+	čekić bušilica	kružna testera	ugaona brusilica	ugaona brusilica
snaga	1 500 W	1 500 W	800 W	1 400 W	900 W	2 400 W
brzina	0 - 520 min-1	0 - 850 min-1	0 - 1 350 min-1	0 - 4 500 min-1	0 - 11 000 min-1	0 - 6 600 min-1
BPM	0 - 4 100	0 - 4 500	0 - 5 500			
udar	12 J	6 J	2,8 J			
stezna glava	SDS MAX	SDS+	SDS+ ø 2 - 13 mm	20 mm	M14 / 22,2 mm	M14 / 22,2 mm
Podesiv ugao sečenja				0 - 45°		
dubina rezanja 45°				42 mm		
dubina rezanja 90°				63 mm		
mak. prečnika točkovi				185 mm	125 mm	230 mm
težina	6,8 kg	5 kg	3,2 kg	4,3 kg	2 kg	5,8 kg
Kabl za napajanje	3 m guma	2 m guma	2 m guma	2 m plastika	2 m guma	2 m guma
Package contents	čekić bušilica, bočna ručka, graničnik dubine, ključ, plastično kućište, rezervne ugljene četke, dodatna oprema SDS MAX: ø 16 x 280 mm 18 x 320 mm	čekić bušilica, bočna ručka, graničnik dubine, ključ, plastično kućište, rezervne ugljene četke, dodatna oprema SDS+: ø 8, 10, 12 x 160 mm 20 x 250 mm 14 x 250 mm	čekić bušilica, bočna ručka, graničnik dubine, stezna glava ø 2 - 13 mm, plastično kućište, vazelin, rezervne ugljene četke, dodatna oprema SDS+: ø 6, 8, 10 x 160 mm 20 x 250 mm 14 x 250 mm	kružna testera, bočni vodič, ključ, rezervne ugljene četke, list testere ø 185 x 2,3/1,3 x 20 mm 24T	ugaona brusilica, - zaštitnik - bočna ručka - ključ - rezervne ugljene četke	angle grinder, protective guard, side handle, wrench, spare carbon brushes

NEW

brzina
1000 - 1850 min⁻¹

duljina
110 - 180 cm

snaga
750 W

prečnik
točka
Ø 225 mm



ergonomska
gumirana ručka
za udoban
i siguran hvat



FESTA
POWER X TOOLS

BRUSILICA ZA GIPSANE ZIDOVE

230V ~ 50Hz	750W	1000-1850min ⁻¹	Ø 225mm	110-180 cm
LED	4m	DRYWALL		



Br. 28240 Specifikacije

1

NEW



FESTA
POWER X TOOLS

USISIVAČ 30L

230 V ~50 Hz 1600 W MAX 2000W 82dB IPX4 3m 5m

30L WET DRY AUTO ON-OFF AUTOMATIC FILTER CLEANING HEPA

Br.	Specifikacije	
28345		1
28346	HEPA filter	1

NEW



WEST BERG

USISIVAČ 30L

230 V ~50 Hz 1200 W 3m 5m

30L WET DRY AUTO ON-OFF SEMI-AUTOMATIC FILTER CLEANING HEPA

Br.	Specifikacije	
28340		1
28342	HEPA filter	1

FESTA
 POWER X TOOLS

ELEKTRICKÉ MIECHAĎLO STAVEBNÝCH ZMESÍ DVOJMETĽOVÉ

Napon	1800 W
Napon	230 V / 50 Hz
Stepeni brzina	2
1. stепен (brzina bez opterećenja)	0 - 450 ot./min.
2. stепен (brzina bez opterećenja)	0 - 790 ot./min.
Zaštita protiv preopterećen	Da
Prečnik bubnja mešalice	100 mm
Dužina mešača	570 mm
Težina	5,6 kg

Zn CE

Br.	Specifikacije	
35311	mešalica	1
35318	rezervni ugljenik	1
35319	rezervne mešalice - par (L+R)	1

FESTA
 POWER X TOOLS

MEŠALICA GRAĐEVINSKIH SMESA, 1600W

Ulazna snaga	1600 W
Napon	230 V / 50 Hz
Stepeni brzina	2
1. stепен (brzina bez opterećenja)	0 - 480 ot./min
2. stепен (brzina bez opterećenja)	0 - 800 ot./min.
Zaštita protiv preopterećen	Da
Navoj mešača mešalice	M 14
Prečnik bubnja mešalice	140 mm
Dužina mešača	600 mm
Težina	4,7 kg

M14 Zn CE

Br.	Specifikacije	
35310		1
35317	rezervni ugljenik	1

FESTA
 POWER X TOOLS

MEŠALICA GRAĐEVINSKIH SMESA, 850W

Ulazna snaga	850 W
Napon	230 V / 50 Hz
Stepeni brzina	1
1. stепен (brzina bez opterećenja)	0 - 500 ot./min
2. stепен (brzina bez opterećenja)	-
Zaštita protiv preopterećenja	Da
Navoj mešača mešalice	M 14
Prečnik bubnja mešalice	120 mm
Dužina mešača	600 mm
Težina	3,7 kg

M14 Zn CE

Br.	Specifikacije	
35300		1
35316	rezervni ugljenik	1



NEW

**WEST
BERG**

MEŠALICA GRAĐEVINSKIH SMESA, 1600W

Ulazna snaga	1600 W
Napon	230 V / 50 Hz
Stepeni brzina	2
1. stepen (brzina bez opterećenja)	180 - 400 ot./min.
2. stepen (brzina bez opterećenja)	300 - 700 ot./min.
Zaštita protiv preopterećenja	Da
Navoj mešača mešalice	M 14
Prečnik bubnja mešalice	140 mm
Dužina mešača	600 mm
Težina	5,4 kg

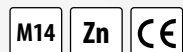

Br.	Specifikacije	
35305		1
35315	rezervni ugljenik	1



NEW



FESTA
POWER X TOOLS

**ELEKTRIČNI PERAČ
POD PRITISKOM**

230 V ~50 Hz	1800 W	IPX5	MAX 7 l/min	MAX 140 bar	MAX 50°C	5m	AUTO STOP	7,8 kg
-----------------	-----------	------	-------------------	-------------------	-------------	----	--------------	-----------

Br.	Specifikacija
45271	



1



FESTA

**ELEKTRIČNI PERAČ
POD PRITISKOM**

230 V ~50 Hz	1500 W	MAX 120 bar	MAX 6 l/min	IPX5	5m	AUTO STOP
-----------------	-----------	-------------------	-------------------	------	----	--------------

Br.	specifikacija
45270	električni perač pod pritiskom



1

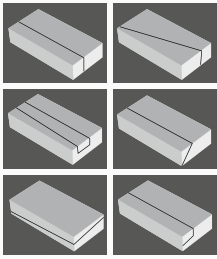

FESTA
POWER X TOOLS

REZAČ STIROPORA

- Voltaža 230 V/50 Hz
- Potrošnja struje 200 W
- Dužina reza 137 cm
- Visina reza 35 cm
- Zaštita IP44
- Ugao rezanja 0° - 90°

· oprema: postolje, nožni prekidač, držač za skele, 2k Ni-Cr žica za sečenje, mesingana četka za čišćenje, alati i pričvršćivači, plastična kutija sa točkovima



Br. Specifikacije

35348



1

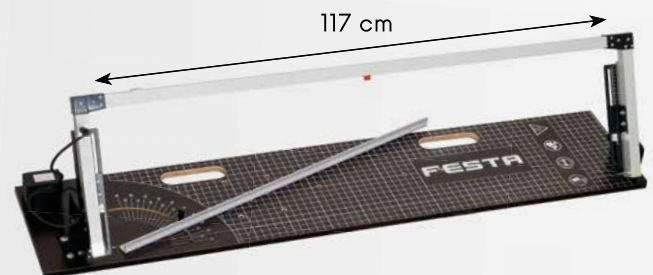
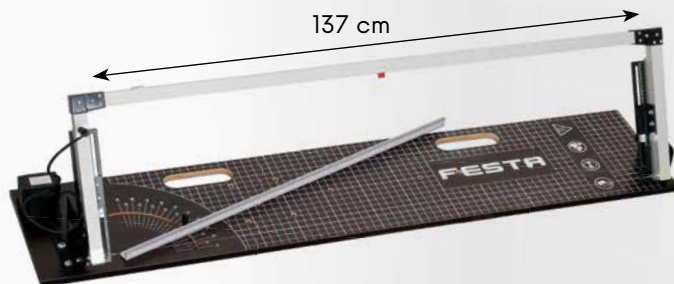
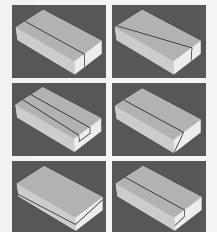
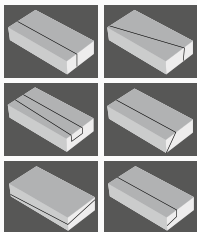

FESTA
POWER X TOOLS

REZAČ STIROPORA

- Voltaža 230 V / 50 Hz
- Potrošnja struje 200 W
- Dužina reza 137 cm
- Visina reza 35 cm
- Zaštita IP44
- Ugao rezanja 0° - 90°



· Oprema: Ni-Cr žica za sečenje, čišćenje četke od mesinga, imbus

Br. Specifikacije

35345



1

FESTA
POWER X TOOLS

REZAČ STIROPORA

- Voltaža 230 V / 50 Hz
- Potrošnja struje 160 W
- Dužina reza 120 cm
- Visina reza 35 cm
- Zaštita IP44
- Ugao rezanja 0° - 90°



· Oprema: Ni-Cr žica za sečenje, čišćenje četke od mesinga, imbus

Br. Specifikacije

35330



1



FESTA

REZAČ STIROPORA

- Voltaža 230 V / 50 Hz
- Potrošnja struje 160 W
- Dužina reza 120 cm
- Visina reza 52 cm
- Zaštita IP44
- Ugao rezanja 0° - 90°



· Oprema: Ni-Cr žica za sečenje, čišćenje četke od mesinga, imbus

Br.	Specifikacije	
35344		1



FESTA

**NOŽNI PREKIDAČ
ZA REZAČ POLISTIRENA**

· za 35330, 35345, 35348



Br.	Specifikacije	
35334		1



FESTA

**STAJATI
ZA REZAČ POLISTIRENA**

· za 35330, 35345, 35348



Br.	Specifikacije	
35336		1



FESTA

**ZAMENA OPRUGE
ZA REZAČ POLISTIRENA**

· za 35330, 35345, 35348



Br.	Specifikacije	
35332		1



FESTA

**DRŽAČ ZA SKELE
ZA REZAČ POLISTIRENA**

· za 35330, 35345, 35348



Br.	Specifikacije	
35333		1



FESTA

**REZERVNI ADAPTER ZA NAPAJANJE
ZA REZAČ POLISTIRENA**

· za 35330, 35345, 35348



Voltaža	230 V / 50Hz
output:	36 V / 5 A
Potrošnja struje	200 W



Br.	Specifikacije	
35347		1

**OTPORNA ŽICA
Ni-Cr
ZA REZAČ POLISTIRENA**

35331 za rezač 117 cm
35346 za rezač 137 cm





Li-ion
technology

FESTA
POWER X TOOLS

REZAČ ZA POLISTIRENSKE, BATERIJE

- baterija **36 V, 1,5Ah Li-ion**
- potrošnja struje **180 W**
- temperature **max 350 C°**
- dužina rezu **20 cm**
- oprema: 2 baterije, punjač, sečivo, mesing četka za čiščenje, šesterokut



Br.	Specifikacija	
35323	Električni rezač stiropora	1
35328	Rezervni nož za rezač stiropora 14 cm	1
35329	Rezervni nož za rezač stiropora 25 cm	1



FESTA
POWER X TOOLS

ELEKTRIČNI REZAČ STIROPORA

- Voltaža **230 V/50 Hz**
- Potrošnja struje **250 W**
- Temperature **50-600 C°**
- Dužina rezu **25 cm**
- Dužina kabla za napajanje **3 m**



· Oprema: čiščenje četke od mesinga, imbus, nož 25 a 30 cm

Br.	Specifikacija	
35326	Električni rezač stiropora	1
35328	Rezervni nož za rezač stiropora 14 cm	1
35329	Rezervni nož za rezač stiropora 25 cm	1

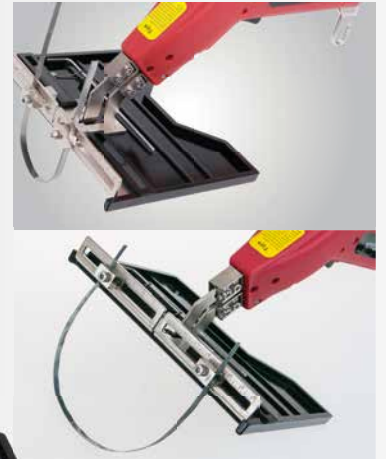

VODJICA ZA REZANJE STIROPORA

Br.	Specifikacija	
35327	Vodilica za rezanje polistirena	1
35335	Rezervni nož - 30 cm	1



FESTA
POWER X TOOLS

ELEKTRIČNI REZAČ STIROPORA



· Regulacija temperature

Br.	Specifikacija	
35325	220 W	1



**FESTA****INVERTER ZA ZAVARIVANJE TIG/MMA 160 A**

Voltaža / frekvencija	230 V / 50 Hz
Voltaža naprédno	55 V
Regulativni domet zavarivanja struja	10 - 160 A
Prečnik elektrode	1,5 - 4,0 mm
Radni ciklus	TIG- 160 A / 60%, MMA- 140 A / 60%
Klasa zaštite	IP 21
Vrsta zavarivanja	TIG/MMA
Dimenzije	405 x 165 x 270 mm
Tehnologija	Anti-stick, Arc-force, Hot start, Lift TIG
Težina Maca	6 kg



Br.	specifikacija
70040	Inverter za zavarivanje



1

FESTA

LCD display

**FESTA****SAMOZATAMNUJUĆA MASKA ZA ZAVARIVANJE**

veličina vidnog polja	98 x 80 mm
brzina zatamnjavanja filtera	1/25 000 s
zatamnjavanje filtera	DIN 5-8 / 9-13
UV / IR zaštita	DIN 16
optička klasa	1 1 1 2
broj senzora	4
napajanje	Solarna ćelija + baterija CR2450
režim rada	Zavarivanje, brušenje

CE EN 379

Br.	specifikacija
70064	aktivan
70066	zamena poklopnog stakla



1

1



**FESTA**SAMOZATAMNUJUĆA
MASKA ZA ZAVARIVANJE

Br.	specifikacija	4
70063	aktivan	

SAMOZATAMNUJUĆA
MASKA ZA ZAVARIVANJE

Br.	specifikacija	4
70060	aktivan	



MASKA ZA ZAVARIVANJE



Br.	specifikacija	4
70061		

REZ. DELOVI STEKLO
ZA VARENJE

2x

Br.	specifikacija	20
70065	113 x 80 mm	



NAOČARE ZA ZAVARIVANJE



Br.	specifikacija	1
70062		

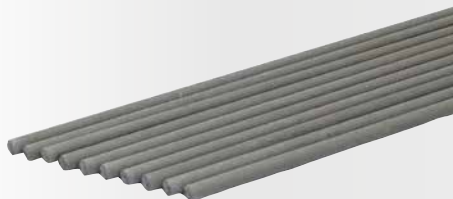

ELEKTRODA RUTIL ER 117

· Certifikovan

Br.	specifikacija	mnoštvi	4
70021	Ø 2,0 x 300 mm	10 kom.	1
70020	Ø 2,0 x 300 mm	2,5 kg	8
70026	Ø 2,5 x 300 mm	10 kom.	1
70025	Ø 2,5 x 300 mm	2,5 kg	8
70033	Ø 3,2 x 350 mm	10 kom.	1
70032	Ø 3,2 x 350 mm	5 kg	4

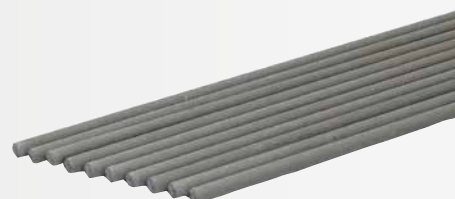

ELEKTRODA BASIC

· Certifikovan

Br.	specifikacija	mnoštvi	4
70030	Ø 2,0 x 300 mm	2,5 kg	1
70031	Ø 2,0 x 300 mm	5 kg	1
70035	Ø 2,5 x 300 mm	2,5 kg	8
70036	Ø 2,5 x 300 mm	10 kom.	1
70037	Ø 3,2 x 350 mm	5 kg	5



VARILAČKI ČEKIĆ



Br.	specifikacija	1
19115	320 g	



KLEŠTA ZA ZAVARIVANJE



Br.	specifikacija	1
70070	300 A	



KLJEŠTA ZA MASU



Br.	specifikacija	1
70075	300 A	



FESTA

MAGNET ZA ZAVARIVANJE UGAONI



Br.	specifikacija	nosnost	
70096	150 x 130 x 30 mm · 45°, 90°, 135°	25 kg	10



MAGNET ZA ZAVARIVANJE UGAONI



Br.	specifikacija	nosnost	
70090	85 x 85 mm · 45°, 90°	9 kg	10



MAGNET ZA ZAVARIVANJE UGAONI



Br.	specifikacija	nosnost	
70093	95 x 64 mm · 30°, 45°, 60°, 75°, 90°	9 kg	10
70094	120 x 90 mm · 30°, 45°, 60°, 75°, 90°	18 kg	10
70095	137 x 110 mm · 30°, 45°, 60°, 75°, 90°	27 kg	10



MAGNET ZA ZAVARIVANJE UGAONI



Br.	specifikacija	nosnost	
70091	95 x 109 x 25 mm · 45°, 90°, 135°	13 kg	10
70092	130 x 150 x 32 mm · 45°, 90°, 135°	22 kg	5



FESTA
POWER X TOOLS

PEGLA ZA SPAJANJE PVC CEVI SA REGULACIJOM TOPLOTE

- Napon 230 V / 50 Hz
- Potrošnja energije 750 / 1500 W
- Temperatura 0-300 C°
- Za prečnike Ø 20,25,32,40,50,63 mm
- Težina 1,6 kg



· Sadržaj kompleta: metar, libela, inbus ključ, klešta za cevi, 6 adaptera za lemljenje cevi, metalna kutija



Br.	
17182	1



FESTA
POWER X TOOLS

PEGLA ZA SPAJANJE PVC CEVI SA REGULACIJOM TOPLOTE

- Napon 230 V / 50 Hz
- Potrošnja energije 800 / 1000 W
- Temperatura 0-300 C°
- Za prečnike Ø 16, 20, 25, 32 mm
- Težina 1 kg



· Sadržaj kompleta: 4 adaptera za lemljenje cevi, 4 adaptera za lemljenje cevi, metalna kutija kufr



Br.	
17183	1

FESTA**KOMPRESOR 6 L - BEZ ULJA**

Voltaža / frekvencija	230 V / 50Hz
Potrošnja struje	1,2 kW (1,5HP)
Volumen spremnika	6 l
Makom. pritisak	8 Bar
Brzina	3900 min.
Usisna snaga	180 l/min.
Performanse punjenja	116 l/min.
Težina	10 kg



Br.

35360



1

**KOMPRESOR 24 L - BEZ ULJA**

Učinek	1100 W
Voltaža / frekvencija	230 V / 50Hz
Pokreni bez opterečenja	2850 min-1
Radni pritisak	8 bar
Usis vazduha	160 l / min
Tip	without oil / Безмаслен
Volumen spremnika	24 L
Težina	23 kg



Br.

specifikacija

35361 1,1 kW, 24 l



1

**KOMPRESOR 24 L**

Učinek	1500 W
Voltaža / frekvencija	230 V / 50Hz
Pokreni bez opterečenja	2850 min-1
Radni pritisak	8 bar
Usis vazduha	200 l / min
Tip	oil / Маслен
Volumen spremnika	24 L
Težina	24 kg



Br.

specifikacija

35362 1,5 kW, 24 l



1



500 ml

FESTA**PNEUMATSKI PIŠTOLJ ZA FARBANJE**

ø 1,5 mm



Br.

specifikacija

48020 Gornji

1



600 ml

FESTA**PNEUMATSKI PIŠTOLJ ZA FARBANJE**

ø 1,4 mm



Br.

specifikacija

48021 Gornji

1

48047 Mlaznica ø 1,7 mm

1



1000 ml

FESTA**PNEUMATSKI PIŠTOLJ ZA FARBANJE**

ø 1,4 mm



Br.

specifikacija

48022 Gornji

1

48046 Mlaznica ø 1,5 mm

1

FESTA

PNEUMATSKI PIŠTOLJ SA NASTAVCIMA



Br. 48030 specifikacija Donji 1



PIŠTOLJ ZA PRSKANJE BOJA I MALTERA

- 4 - 6 Bar
- 5 l
- Mlaznica Ø 4; 6; 8 mm



Br. 48037 specifikacija 1

FESTA

PNEUMATSKI PIŠTOLJ

- 25 mm
- 90 mm
- 190 mm



Br. 48004 specifikacija 10



FESTA

PNEUMATSKI PIŠTOLJ KRAČI



Br. 48005 specifikacija Kratki 25



FESTA

PNEUMATSKI PIŠTOLJ SREDNJI



Br. 48006 specifikacija Srednja 25



FESTA

PNEUMATSKI PIŠTOLJ DUŽI



Br. 48007 specifikacija Dugo 25



FESTA

PIŠTOLJ RASPRSKIVAČ ZA KOMPRESOR



Br. 48015 specifikacija Donji 1



FESTA

PIŠTOLJ ZA PUKOTINE I OTVORE – ZA KOMPRESOR



Br. 48036 specifikacija Donji 1





30 cm

FESTA

PIŠTOLJ ZA PRITISAK SA MERAČEM

- 0 - 10 bar
- LCD display
- bar, kPa, Psi, kgf/cm²

2x AAA

Br.	specifikacija	
48011	0 - 10 bar	10



FESTA

PIŠTOLJ ZA PRITISAK SA MERAČEM

Br.	specifikacija	
48010		1



FESTA

KOMPLET ALATA ZA KOMPRESOR VEĆI

5x

1. Pištolj raspršivač
2. Pistolj na pritisak sa meracem
3. Pištolj raspršivač
4. Udarni pistolj
5. Spiralno crevo sa priključcima

Br.	specifikacija	
48001		1



FESTA

KOMPLET ALATA ZA KOMPRESOR MANJI

3x

1. Pistolj na pritisak sa meracem
2. Udarni pistolj
3. Spiralno crevo sa priključcima

Br.	specifikacija	
48002		1

NEW

ADAPTERI ZA KOMPRESORE

8x

Br.	specifikacija	
48013		1



FESTA

SPIRALNO CREVO ZA VAZDUH SA PRIKLJUČCIMA

Br.	specifikacija	
48043	5 m 8 atm ø 10 mm	1



FESTA

SPIRALNO CREVO ZA VAZDUH SA PRIKLJUČCIMA

Br.	specifikacija	
48040	5 m 8 atm ø 8 mm	1
48041	10 m 8 atm ø 8 mm	1
48042	15 m 8 atm ø 8 mm	1



FESTA

SPIRALNO CREVO ZA VAZDUH SA PRIKLJUČCIMA

Br.	specifikacija	
48031	5 m ø 9/15 mm	1
48032	10 m ø 9/15 mm	1
48033	15 m ø 9/15 mm	1
48034	20 m ø 9/15 mm	1

FESTA

FILTER

· Max. 10 bar



Br.	specifikacija	
48008	G 1/4'	1

FESTA

REGULATOR PRITISKA SA MANOMETROM

· 0 - 10 bar



Br.	specifikacija	
48009	G 1/4'	1

FESTA

REZERVNE MLAZNICE

· Za 48021



Br.	specifikacija	
48047	Mlaznica Ø 1,7 mm	1

FESTA

REZERVNE MLAZNICE

· Za 48022



Br.	specifikacija	
48046	Mlaznica Ø 1,5 mm	1

TABELA MERA CEVNIH WHITWORTH NAVOJA

VELIČINA NAVOJA G U PALCIMA	MAKOMIMALNI VANJSKI Ø NAVOJA U MM
1/8	9,728
1/4	13,157
3/8	16,662
1/2	20,955
3/4	26,441
1	33,249



PNEUMATSKE SPOJNICE

Br.	specifikacija	
48075	1/4' spolja	10
48076	3/8' spolja	10
48077	1/2' spolja	10
48095	1/4' unutra	10
48096	3/8' unutra	10
48097	1/2' unutra	10

ADAPTER – REDUKTOR

Br.	specifikacija	
48050	Spolja 1/4' spolja x 1/4' spolja	10
48051	Umanjenje 1/4' spolja x 3/8' spolja	10



PNEUMATSKA SPOJNICA

Br.	specifikacija	
48085	1/4' - 6 mm	10
48086	3/8' - 9 mm	10
48087	1/2' - 13 mm	10



PNEUMATSKA SPOJNICA

Br.	specifikacija	
48070	1/4' - 6 mm	10
48071	3/8' - 9 mm	10
48072	1/2' - 13 mm	10



ADAPTER –REDUKTOR

Br.	specifikacija	
48054	3/8' spolja x 1/4' unutra	10
48055	1/2' spolja x 3/8' unutra	10
48056	Umanjenje 3/8' spolja x 1/2' unutra	10
48057	Umanjenje 1/4' spolja x 3/8' unutra	10



PNEUMATSKI ADAPTER

Br.	specifikacija	
48060	Ø 6 mm - 1/8' spolja	10
48061	Ø 6 mm - 1/4' spolja	10
48062	Ø 6 mm - 3/8' spolja	10
48063	Ø 9 mm - 1/4' spolja	10
48064	Ø 9 mm - 3/8' spolja	10
48065	Ø 13 mm - 1/4' spolja	10
48066	Ø 13 mm - 3/8' spolja	10
48067	Ø 6 mm - 3/8' unutra	10
48068	Ø 9 mm - 3/8' unutra	10
48093	Ø 6 mm - 1/4' unutra	10
48094	Ø 9 mm - 1/4' unutra	10



PNEUMATSKI ADAPTER

Br.	specifikacija	
48080	1/4' spolja	10
48081	3/8' spolja	10
48090	3/8' unutra	10
48091	1/4' unutra	10



FESTA
POWER X TOOLS

TOPLI VAZDUŠNI PIŠTOLJ SA REGULACIJOM TEMPERATURE

Napon	230V / 50Hz
Ulazna snaga	2000W
Prekidač	0 - I (350°C) - II (550°C)
Pribor	Oprema - 4 Kom



Br.	Specifikacije
35320	2000 W

1



FESTA
POWER X TOOLS

TOPLI VAZDUŠNI PIŠTOLJ SA REGULACIJOM TEMPERATURE

Napon	230V / 50 Hz
Ulazna snaga	2000 W
Prekidač	0 - I (50°C) - II (50 - 600°C)
Protok vazduha	120 - 500 l/min.
Pribor	Oprema - 4 Kom



Br.	Specifikacije
35322	2000 W

1

NEW



WEST BERG
LEMILICA PIŠTOLJ

230V
~ 50Hz **175W**

Br.	Specifikacije
28275	
28278	Vrh Pištolj lemilice 3kom

1

1



1

1



NEW



WEST BERG
ŠTAP LEMILICA

230V
~ 50Hz **60W**

Br.	Specifikacije
28280	
28282	Vrh štap lemilice 2kom

1

1



1

1



FESTA
POWER X TOOLS

**PIŠTOLJ ZA PLASTIKU
BEŽIČNI**

· Ø epljivi štapić 11,2 mm

230V
~ 50Hz

80W



Br. Specifikacije

89975

20

NEW



FESTA
POWER X TOOLS

**PIŠTOLJ
ZA PLASTIKU**

· Ø epljivi štapić 7,2 mm

230V
~ 50Hz

12W



**PIŠTOLJ
ZA PLASTIKU**

· Ø epljivi štapić 7,2 mm

230V
~ 50Hz

15W



**PIŠTOLJ
ZA PLASTIKU**

· Ø epljivi štapić 11,2 mm

230V
~ 50Hz

60W



Br. Specifikacije

89775

1

Br. Specifikacije

89970

25

Br. Specifikacije

89973

20



STAPNA MUNICIJA

Br.	Ø	Dužina		
89980	7,2 mm	100 mm	12 Kom	100
89988	7,2 mm	100 mm	1 kg	25



STAPNA MUNICIJA

Br.	Ø	Dužina		
89985	11,2 mm	200 mm	10 Kom	50
89987	11,2 mm	200 mm	1 kg	25



STAPNA MUNICIJA

Br.	Ø	Dužina		
89989	7,2 mm	100 mm	12 Kom	100
89990	11,2 mm	200 mm	10 Kom	50



ELEKTRIČNI GREJAČ 3,3KW

Napon	230V ~50 Hz
Snaga	3300 W
Current load	14.5 A
Set up performance	30/1650/3300 W
Temperaturni opseg	5-40°C
Zaštita	IP24
Mere	27 x 25.5 x 40 cm
Težina	4.8 kg

- fast and efficient heating of cellars, workKomhops, shops, party tents, greenhouses etc. |
- does not consume oxygen
- safe operation, continuous power control, room thermostat, fan
- stainless steel heating element
- possibility of summer use for ventilation without heating
- low noise
- high-quality processing, materials, robust steel construction, easy and safe handling, long service life



Br.	Specifikacije
35833	3,3 kW



1

GREJAČ NA PLIN 15KW

Plin	G30-I3B/P
Pritisak	0.7 bar
Napon	230 V 50 Hz
Engine output	25 W
Potrošnja plina	1.11 kg/h
Max snaga	15 kW
Protok vazduha	300 m ³ /h

- fast and efficient heating during construction work, workKomhops
- It consumes oxygen
- safe operation, smooth power regulation
- thermostat and safety valve against overheating and leakage
- accessories included - controller and inlet gas hose
- high-quality processing, materials, robust steel construction, easy and safe handling with a long service life



Br.	Specifikacije
35845	15 kW



1

GREJAČ NA PLIN 30KW

Plin	g30-i3b/p
Pritisak	1.5 bar
Napon	230 V 50 Hz
Engine output	70 W
Potrošnja plina	2.2 kg/h
Max snaga	30 kW
Protok vazduha	750 m ³ /h

- fast and efficient heating during construction work, workKomhops
- It consumes oxygen!
- direct air heating with forced circulation - rapid heat gain
- safe operation, smooth power regulation
- thermostat and safety valve against overheating and leakage
- accessories included - controller and inlet gas hose
- high-quality processing, materials, robust steel construction, easy and safe handling with a long service life



Br.	Specifikacije
35850	30 kW



1



FESTA

REFLEKTOR LED



Br.	Specifikacije	
37611		1



FESTA

REFLEKTOR LED SA STALKOM

· Max. 180 cm

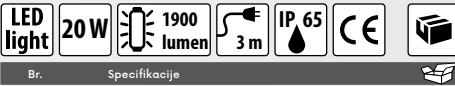

Br.	Specifikacije	
37615	20 W	1
37616	2 x 20 W	1



NEW



FESTA
INDUSTRY

PRODUŽNI KABEL NA MOTALICI

- rubber - IP44
- H07RN-F3G - 2,5mm²
- equipped with a thermal fuse
- 16 A max. / 3680 W max.
- 4 socket

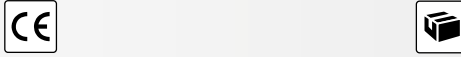

Br.	Specifikacije	
37740	dužina 25 m, 2,5 mm ²	2
37741	dužina 50 m, 2,5 mm ²	2

NEW



FESTA
INDUSTRY

PRODUŽNI KABEL NA MOTALICI

- rubber - IP44
- H05RR-F3G - 1,5mm²
- equipped with a thermal fuse
- 16 A max. / 3680 W max.
- 4 socket

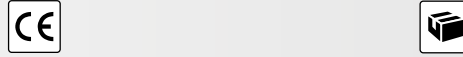

Br.	Specifikacije	
37750	dužina 25 m, 1,5 mm ²	2
37751	dužina 50 m, 1,5 mm ²	2



FESTA

PRODUŽNI KABEL NA MOTALICI

- IP20
- H05VV - F 3G 1,5mm²
- Equipped with a thermal fuse
- Welding power: 1000 W max.
- Output power: 3000 W max.
- 4 sockets



Br.	Specifikacije	
37760	dužina 25 m, 1,5 mm ²	2
37761	dužina 50 m, 1,5 mm ²	2

FESTA
INDUSTRY

PRODUŽNI KABEL

- rubber - IP44
- H07RN-F3G - 1,5mm²
- 16 A max. / 3680 W max.



Br.	Specifikacije	
37744	dužina 5 m, 1,5 mm ²	8
37745	dužina 10 m, 1,5 mm ²	4
37746	dužina 20 m, 1,5 mm ²	8
37747	dužina 30 m, 1,5 mm ²	8

NEW

FESTA

PRODUŽNI KABEL

- IP20
- H05VV-F3G - 1,5mm²
- 16 A max. / 3680 W max.



Br.	Specifikacije	
37730	dužina 10 m, 1,5 mm ²	8
37731	dužina 20 m, 1,5 mm ²	4
37732	NEW dužina 30 m, 1,5 mm ²	8
37733	NEW dužina 40 m, 1,5 mm ²	4





ALAT ZA SEČENJE

54 - 93



FESTA

BURGIJA SPIRALNA HSS-G COBALT 5 %

Co 5%, W 6%
Mo 5%, Cr 4%, V 4%**HSS****DIN**
338**135°****INOX****1400**
MPa

Br.	Specifikacija	Br.	Specifikacija	Br.	Specifikacija
22510	Ø 1,00 mm	22548	Ø 4,80 mm	22590	Ø 9,00 mm
22515	Ø 1,50 mm	22550	Ø 5,00 mm	22595	Ø 9,50 mm
22520	Ø 2,00 mm	22555	Ø 5,50 mm	22600	Ø 10,00 mm
22525	Ø 2,50 mm	22560	Ø 6,00 mm	22602	Ø 10,20 mm
22530	Ø 3,00 mm	22565	Ø 6,50 mm	22605	Ø 10,50 mm
22532	Ø 3,20 mm	22568	Ø 6,80 mm	22610	Ø 11,00 mm
22535	Ø 3,50 mm	22570	Ø 7,00 mm	22615	Ø 11,50 mm
22540	Ø 4,00 mm	22575	Ø 7,50 mm	22620	Ø 12,00 mm
22542	Ø 4,20 mm	22580	Ø 8,00 mm	22625	Ø 12,50 mm
22545	Ø 4,50 mm	22585	Ø 8,50 mm	22630	Ø 13,00 mm

FESTA

BURGIJA SPIRALNA HSS-G W 9 %

W 9%, Mo 3%
Cr 4%, V 1%**HSS****DIN**
338**INOX****1100**
MPa**MOQ**

Br.	Specifikacija	Br.	Specifikacija	Br.	Specifikacija	Br.	Specifikacija
19530	Ø 1,00 mm	19579	Ø 5,90 mm	19612	Ø 9,20 mm	19639	Ø 11,90 mm
19535	Ø 1,50 mm	19580	Ø 6,00 mm	19613	Ø 9,30 mm	19640	Ø 12,00 mm
19536	Ø 1,60 mm	19585	Ø 6,50 mm	19614	Ø 9,40 mm	19641	Ø 12,10 mm
19537	Ø 1,70 mm	19586	Ø 6,60 mm	19615	Ø 9,50 mm	19642	Ø 12,20 mm
19538	Ø 1,80 mm	19587	Ø 6,70 mm	19616	Ø 9,60 mm	19643	Ø 12,30 mm
19539	Ø 1,90 mm	19588	Ø 6,80 mm	19617	Ø 9,70 mm	19644	Ø 12,40 mm
19540	Ø 2,00 mm	19589	Ø 6,90 mm	19618	Ø 9,80 mm	19645	Ø 12,50 mm
19543	Ø 2,30 mm	19590	Ø 7,00 mm	19619	Ø 9,90 mm	19646	Ø 12,60 mm
19544	Ø 2,40 mm	19591	Ø 7,10 mm	19620	Ø 10,00 mm	19647	Ø 12,70 mm
19545	Ø 2,50 mm	19593	Ø 7,30 mm	19621	Ø 10,10 mm	19648	Ø 12,80 mm
19550	Ø 3,00 mm	19594	Ø 7,40 mm	19622	Ø 10,20 mm	19649	Ø 12,90 mm
19552	Ø 3,20 mm	19595	Ø 7,50 mm	19623	Ø 10,30 mm	19650	Ø 13,00 mm
19554	Ø 3,40 mm	19596	Ø 7,60 mm	19624	Ø 10,40 mm	19651	Ø 13,20 mm R13
19555	Ø 3,50 mm	19597	Ø 7,70 mm	19625	Ø 10,50 mm	19652	Ø 13,50 mm R13
19557	Ø 3,70 mm	19598	Ø 7,80 mm	19626	Ø 10,60 mm	19653	Ø 14,00 mm R13
19559	Ø 3,90 mm	19599	Ø 7,90 mm	19627	Ø 10,70 mm	19654	Ø 14,50 mm R13
19560	Ø 4,00 mm	19600	Ø 8,00 mm	19628	Ø 10,80 mm	19655	Ø 15,00 mm R13
19562	Ø 4,20 mm	19601	Ø 8,10 mm	19629	Ø 10,90 mm	19656	Ø 15,50 mm R13
19564	Ø 4,40 mm	19603	Ø 8,30 mm	19630	Ø 11,00 mm	19657	Ø 16,00 mm R13
19565	Ø 4,50 mm	19604	Ø 8,40 mm	19631	Ø 11,10 mm	19658	Ø 16,50 mm R13
19567	Ø 4,70 mm	19605	Ø 8,50 mm	19632	Ø 11,20 mm	19659	Ø 17,00 mm R13
19568	Ø 4,80 mm	19606	Ø 8,60 mm	19633	Ø 11,30 mm	19660	Ø 17,50 mm R13
19570	Ø 5,00 mm	19607	Ø 8,70 mm	19634	Ø 11,40 mm	19661	Ø 18,00 mm R13
19574	Ø 5,40 mm	19608	Ø 8,80 mm	19635	Ø 11,50 mm	19662	Ø 18,50 mm R13
19575	Ø 5,50 mm	19609	Ø 8,90 mm	19636	Ø 11,60 mm	19663	Ø 19,00 mm R13
19576	Ø 5,60 mm	19610	Ø 9,00 mm	19637	Ø 11,70 mm	19664	Ø 19,50 mm R13
19577	Ø 5,70 mm	19611	Ø 9,10 mm	19638	Ø 11,80 mm	19665	Ø 20,00 mm R13
19578	Ø 5,80 mm						

FESTABOX - BURGIJA SPIRALNA
HSS-G W 9 %
- KOMPLETW 9%, Mo 3%
Cr 4%, V 1%**HSS****DIN**
338**INOX****1100**
MPa

Br.	Specifikacija	Br.	Specifikacija
19669		1	
90191	bez burgija	1	



Br.	sadržaj kompleta	Br.	sadržaj kompleta
19530	Ø 1,00 mm 20x	19585	Ø 6,50 mm 15x
19535	Ø 1,50 mm 20x	19590	Ø 7,00 mm 15x
19540	Ø 2,00 mm 20x	19595	Ø 7,50 mm 15x
19545	Ø 2,50 mm 20x	19600	Ø 8,00 mm 15x
19550	Ø 3,00 mm 20x	19605	Ø 8,50 mm 15x
19552	Ø 3,20 mm 20x	19610	Ø 9,00 mm 15x
19555	Ø 3,50 mm 20x	19615	Ø 9,50 mm 15x
19558	Ø 3,80 mm 20x	19620	Ø 10,00 mm 15x
19560	Ø 4,00 mm 30x	19625	Ø 10,50 mm 6x
19562	Ø 4,20 mm 20x	19630	Ø 11,00 mm 6x
19565	Ø 4,50 mm 20x	19635	Ø 11,50 mm 6x
19568	Ø 4,80 mm 20x	19640	Ø 12,00 mm 6x
19570	Ø 5,00 mm 15x	19645	Ø 12,50 mm 6x
19575	Ø 5,50 mm 15x	19650	Ø 13,00 mm 6x
19580	Ø 6,00 mm 30x		

FESTA

BURGIJA SPIRALNA

W 4%, Mo 3%
Cr 4%, V 1%

HSS

DIN
338



ALU

900
MPa



MOQ

Br.	Specifikacija		Br.	Specifikacija		Br.	Specifikacija		Br.	Specifikacija	
19670	Ø 0,6 mm	10	19703	Ø 4,0 mm	10	19736	Ø 7,3 mm	10	19769	Ø 10,6 mm	5
19671	Ø 0,8 mm	10	19704	Ø 4,1 mm	10	19737	Ø 7,4 mm	10	19770	Ø 10,7 mm	5
19672	Ø 0,9 mm	10	19705	Ø 4,2 mm	10	19738	Ø 7,5 mm	10	19771	Ø 10,8 mm	5
19673	Ø 1,0 mm	10	19706	Ø 4,3 mm	10	19739	Ø 7,6 mm	10	19772	Ø 11,0 mm	5
19674	Ø 1,1 mm	10	19707	Ø 4,4 mm	10	19740	Ø 7,7 mm	10	19773	Ø 11,2 mm	5
19675	Ø 1,2 mm	10	19708	Ø 4,5 mm	10	19741	Ø 7,8 mm	10	19774	Ø 11,3 mm	5
19676	Ø 1,3 mm	10	19709	Ø 4,6 mm	10	19742	Ø 7,9 mm	10	19775	Ø 11,4 mm	5
19677	Ø 1,4 mm	10	19710	Ø 4,7 mm	10	19743	Ø 8,0 mm	10	19776	Ø 11,5 mm	5
19678	Ø 1,5 mm	10	19711	Ø 4,8 mm	10	19744	Ø 8,1 mm	10	19777	Ø 11,6 mm	5
19679	Ø 1,6 mm	10	19712	Ø 4,9 mm	10	19745	Ø 8,2 mm	10	19778	Ø 11,7 mm	5
19680	Ø 1,7 mm	10	19713	Ø 5,0 mm	10	19746	Ø 8,3 mm	10	19779	Ø 11,8 mm	5
19681	Ø 1,8 mm	10	19714	Ø 5,1 mm	10	19747	Ø 8,4 mm	10	19780	Ø 11,9 mm	5
19682	Ø 1,9 mm	10	19715	Ø 5,2 mm	10	19748	Ø 8,5 mm	10	19781	Ø 12,0 mm	5
19683	Ø 2,0 mm	10	19716	Ø 5,3 mm	10	19749	Ø 8,6 mm	5	19782	Ø 12,2 mm	5
19684	Ø 2,1 mm	10	19717	Ø 5,4 mm	10	19750	Ø 8,7 mm	5	19783	Ø 12,5 mm	5
19685	Ø 2,2 mm	10	19718	Ø 5,5 mm	10	19751	Ø 8,8 mm	5	19784	Ø 12,8 mm	5
19686	Ø 2,3 mm	10	19719	Ø 5,6 mm	10	19752	Ø 8,9 mm	5	19785	Ø 12,9 mm	5
19687	Ø 2,4 mm	10	19720	Ø 5,7 mm	10	19753	Ø 9,0 mm	5	19786	Ø 13,0 mm	5
19688	Ø 2,5 mm	10	19721	Ø 5,8 mm	10	19754	Ø 9,1 mm	5	19787	Ø 13,2 mm R13	5
19689	Ø 2,6 mm	10	19722	Ø 5,9 mm	10	19755	Ø 9,2 mm	5	19788	Ø 13,5 mm R13	5
19690	Ø 2,7 mm	10	19723	Ø 6,0 mm	10	19756	Ø 9,3 mm	5	19789	Ø 14,0 mm R13	5
19691	Ø 2,8 mm	10	19724	Ø 6,1 mm	10	19757	Ø 9,4 mm	5	19790	Ø 14,5 mm R13	5
19692	Ø 2,9 mm	10	19725	Ø 6,2 mm	10	19758	Ø 9,5 mm	5	19791	Ø 15,0 mm R13	5
19693	Ø 3,0 mm	10	19726	Ø 6,3 mm	10	19759	Ø 9,6 mm	5	19792	Ø 15,5 mm R13	5
19694	Ø 3,1 mm	10	19727	Ø 6,4 mm	10	19760	Ø 9,7 mm	5	19793	Ø 16,0 mm R13	5
19695	Ø 3,2 mm	10	19728	Ø 6,5 mm	10	19761	Ø 9,8 mm	5	19794	Ø 16,5 mm R13	5
19696	Ø 3,3 mm	10	19729	Ø 6,6 mm	10	19762	Ø 9,9 mm	5	19795	Ø 17,0 mm R13	5
19697	Ø 3,4 mm	10	19730	Ø 6,7 mm	10	19763	Ø 10,0 mm	5	19796	Ø 17,5 mm R13	5
19698	Ø 3,5 mm	10	19731	Ø 6,8 mm	10	19764	Ø 10,1 mm	5	19797	Ø 18,0 mm R13	5
19699	Ø 3,6 mm	10	19732	Ø 6,9 mm	10	19765	Ø 10,2 mm	5	19798	Ø 18,5 mm R13	5
19700	Ø 3,7 mm	10	19733	Ø 7,0 mm	10	19766	Ø 10,3 mm	5	19799	Ø 19,0 mm R13	5
19701	Ø 3,8 mm	10	19734	Ø 7,1 mm	10	19767	Ø 10,4 mm	5	19800	Ø 19,5 mm R13	5
19702	Ø 3,9 mm	10	19735	Ø 7,2 mm	10	19768	Ø 10,5 mm	5	19801	Ø 20,0 mm R13	5

FESTA

BOX - BURGIJA SPIRALNA HSS 4341 - KOMPLET

W 4%, Mo 3%
Cr 4%, V 1%

HSS

DIN
338



ALU

900
MPa



Br.	sadržaj kompleta	Br.	sadržaj kompleta
19673	Ø 1,00 mm 20x	19728	Ø 6,50 mm 20x
19678	Ø 1,50 mm 20x	19733	Ø 7,00 mm 10x
19683	Ø 2,00 mm 20x	19738	Ø 7,50 mm 10x
19688	Ø 2,50 mm 20x	19743	Ø 8,00 mm 10x
19693	Ø 3,00 mm 30x	19748	Ø 8,50 mm 10x
19695	Ø 3,20 mm 30x	19753	Ø 9,00 mm 10x
19698	Ø 3,50 mm 30x	19758	Ø 9,50 mm 10x
19701	Ø 3,80 mm 30x	19763	Ø 10,00 mm 10x
19703	Ø 4,00 mm 30x	19768	Ø 10,50 mm 10x
19705	Ø 4,20 mm 30x	19772	Ø 11,00 mm 10x
19708	Ø 4,50 mm 30x	19776	Ø 11,50 mm 10x
19711	Ø 4,80 mm 30x	19781	Ø 12,00 mm 10x
19713	Ø 5,00 mm 20x	19783	Ø 12,50 mm 10x
19718	Ø 5,50 mm 20x	19786	Ø 13,00 mm 5x
19723	Ø 6,00 mm 20x		

FESTA

BURGIJA SPIRALNA HSS PRODUŽENE

W 4%, Mo 3%
Cr 4%, V 1%

HSS

DIN
340



ALU



MOQ

Br.	Specifikacija		Br.	Specifikacija		Br.	Specifikacija	
20220	Ø 2,0 mm x 85 mm	1	20245	Ø 4,5 mm x 126 mm	1	20280	Ø 8,0 mm x 165 mm	1
20225	Ø 2,5 mm x 95 mm	1	20250	Ø 5,0 mm x 132 mm	1	20290	Ø 9,0 mm x 175 mm	1
20230	Ø 3,0 mm x 100 mm	1	20255	Ø 5,5 mm x 139 mm	1	20296	Ø 10,0 mm x 184 mm	1
20235	Ø 3,5 mm x 110 mm	1	20260	Ø 6,0 mm x 139 mm	1			
20240	Ø 4,0 mm x 119 mm	1	20270	Ø 7,0 mm x 156 mm	1			

BURGIJA SPIRALNA HSS TIN

· Vrh do titana omogućava bolju opotrebu i vek trajanja

TiN **HSS** **DIN 338**



Br.	Specifikacija	📦
20400	Ø 1,0 mm	1
20401	Ø 1,5 mm	1
20402	Ø 2,0 mm	1
20403	Ø 2,5 mm	1
20404	Ø 3,0 mm	1
20405	Ø 3,2 mm	1
20406	Ø 3,5 mm	1
20407	Ø 3,8 mm	1
20408	Ø 4,0 mm	1
20409	Ø 4,2 mm	1
20410	Ø 4,5 mm	1

Br.	Specifikacija	📦
20411	Ø 4,8 mm	1
20412	Ø 5,0 mm	1
20413	Ø 5,5 mm	1
20414	Ø 6,0 mm	1
20415	Ø 6,5 mm	1
20416	Ø 6,8 mm	1
20417	Ø 7,0 mm	1
20418	Ø 7,5 mm	1
20419	Ø 8,0 mm	1
20420	Ø 8,5 mm	1
20421	Ø 9,0 mm	1

Br.	Specifikacija	📦
20422	Ø 9,5 mm	1
20423	Ø 10,0 mm	1
20424	Ø 10,2 mm	1
20425	Ø 10,5 mm	1
20426	Ø 11,0 mm	1
20427	Ø 11,5 mm	1
20428	Ø 12,0 mm	1
20429	Ø 12,5 mm	1
20430	Ø 13,0 mm	1

BURGIJA SPIRALNA HSS

HSS **DIN 338**

ALU



Br.	Specifikacija	📦
19841	Ø 4,1 mm 5 ks	10
19842	Ø 4,2 mm 5 ks	10
19845	Ø 4,5 mm 5 ks	10
19885	Ø 8,5 mm 1 ks	10
19895	Ø 9,5 mm 1 ks	10



FESTA

HSS-G KOMPLET BURGIJA ZA METAL

W 9%, Mo 3%
Cr 4%, V 1% **HSS** **DIN 338**

13x



Br.	Specifikacija	📦
20333	Ø 1,5 - 6,5 mm	20



FESTA

HSS-G KOMPLET BURGIJA ZA METAL

W 9%, Mo 3%
Cr 4%, V 1% **HSS** **DIN 338**

19x



Br.	Specifikacija	📦
20334	Ø 1,0 - 10,0 mm	20



FESTA

HSS-G KOMPLET BURGIJA ZA METAL

W 9%, Mo 3%
Cr 4%, V 1% **HSS** **DIN 338**

25x



Br.	Specifikacija	📦
20335	Ø 1,0 - 13,0 mm	5



FESTA

KOMPLET BURGIJA ZA METAL

W 4%, Mo 3%
Cr 4%, V 1% **HSS** **DIN 338**

13x



Br.	Specifikacija	📦
20336	Ø 1,5 - 6,5 mm	1



FESTA

KOMPLET BURGIJA ZA METAL

W 4%, Mo 3%
Cr 4%, V 1% **HSS** **DIN 338**

19x



Br.	Specifikacija	📦
20337	Ø 1,0 - 10,0 mm	20



FESTA

KOMPLET BURGIJA ZA METAL

W 4%, Mo 3%
Cr 4%, V 1% **HSS** **DIN 338**

25x



Br.	Specifikacija	📦
20338	Ø 1,0 - 13,0 mm	10

FESTA

KOMPLET BURGIIJA

TiN



9x

Br. 20317 Specifikacija Ø 5-6-8 mm



20



FESTA

KOMPLET BURGIIJA SA ŠESTOUGAONIM DRŽAČEM

1/4" HSS

ALU

7x

Br. 20316 Specifikacija Ø 1,5-2-3-4-5-5,5-6 mm



20



KOMPLET BURGIIJA ZA META

HSS DIN 338



19x

Br. 20305 Specifikacija Ø 1,0 - 13,0 mm



25



KOMPLET BURGIIJA ZA META

HSS DIN 338



25x

Br. 20311 Specifikacija Ø 1,0 - 13,0 mm



10



KOMPLET BURGIIJA ZA META

HSS DIN 338



13x

Br. 20300 Specifikacija Ø 1,5 - 6,5 mm



50



KOMPLET BURGIIJA ZA META

HSS DIN 338



19x

Br. 20310 Specifikacija Ø 1 - 13 mm



10



KOMPLET BURGIIJA

- burgija za drvo Ø 3 · 4 · 5 · 6 · 8 mm
- burgija za metal Ø 1 · 1,5 · 2 · 2,5 · 3 · 3,5 · 4 · 4,5 · 5 · 5,5 · 6 · 7 · 8 · 10 mm
- burgija za zidanje Ø 4 · 5 · 6 · 8 · 10 mm
- ravna burgija za drvo Ø 16 · 22 · 25 mm
- testera za otvore Ø 32 · 38 · 44 · 54 mm
- graničnici dubine Ø 6 · 8 · 10 mm
- tačkasti probijač
- merač prečnika burgije

- bit 25 mm
 - ⊖ S 3 · 4 · 4 · 5 · 5 · 6 · 6 · 7
 - ⊕ PH 0 · 0 · 1 · 1 · 2 · 2 · 2 · 3 · 3
 - ⊗ PZ 0 · 0 · 1 · 1 · 2 · 2 · 2 · 3 · 3
 - H 2 · 2,5 · 3 · 3,5 · 4 · 5 · 6
 - ⊗ T 10 · 15 · 20 · 25 · 27 · 30 · 40

- bit 50 mm
 - ⊖ S 4 · 5 · 6 · 6
 - ⊕ PH 1 · 2 · 2 · 3
 - ⊗ PZ 1 · 2 · 2 · 3

- adapter alat za skidanje ivica ○ 4 · 5 · 6 · 7 · 8 · 9 · 10 · 13 mm
- držač bitova

100x

Br. Specifikacija

20340



1



KOMPLET BURGIIJA

HSS DIN 338



19x

Br. Specifikacija

20315 Ø 1 - 10 mm

10

KOMPLET BURGIIJA ZA METAL

TiN HSS DIN 338



19x

Br. Specifikacija

20320 Ø 1 - 10 x 0,5 mm



30



KOMPLET BURGIIJA ZA METAL

HSS DIN 338



19x

Br. Specifikacija

20321 Ø 1 - 10 x 0,5 mm



5



OŠTRAČ ZA BURGIIJE

Br. Specifikacija

20380 za Ø 3,5 - 10 mm



20

FESTA

IZREZIVAČ RUPA BI-METAL



Br.	Specifikacija	
24419	Ø 19 mm	1
24420	Ø 20 mm	1
24422	Ø 22 mm	1
24425	Ø 25 mm	1
24429	Ø 29 mm	1
24432	Ø 32 mm	1
24435	Ø 35 mm	1
24437	Ø 37 mm	1
24444	Ø 44 mm	1
24451	Ø 51 mm	1
24457	Ø 57 mm	1
24464	Ø 64 mm	1
24468	NEW Ø 68 mm	1
24476	Ø 76 mm	1
24483	Ø 83 mm	1



14 - 30 mm

FESTA

NOSAČ ZA IZREZIVAČ RUPA

Br. Specifikacija

24410 za rupa 14 - 30 mm



1



32 - 152 mm

FESTA

NOSAČ ZA IZREZIVAČ RUPA

Br. Specifikacija

24411 za rupa 32 - 152 mm



1

FESTA

BURGIIJA ZA NOSAČ ZA IZREZIVAČ RUPA

za 24410, 24411

Br. Specifikacija

24412



5

FESTA

KOMPLET
IZREZIVAČA RUPA,
HSS BI-METAL

HSS



9x

Br.	Specifikacija	10
24750	Ø 19, 22, 29, 38, 44, 57 mm	



FESTA

KOMPLET
IZREZIVAČA RUPA,
BI-METAL

HSS



13x

Br.	Specifikacija	10
24751	Ø 19, 22, 29, 35, 38, 44, 51, 57, 64 mm	



FESTA

STEPENASTA BURGIJA TIN

TiN

HSS



Br.	Specifikacija	20
20489	Ø 4 - 12 mm 9 stepena	
20490	Ø 4 - 20 mm 9 stepena	10
20491	Ø 5 - 35 mm 13 stepena	10
20492	Ø 7 - 40,5 mm 13 stepena	5



FESTA

STEPENASTA BURGIJA TIN
KOMPLET

TiN

HSS



3x

Br.	Specifikacija	1
20495	Ø 4 - 12, 4 - 20, 4 - 32 mm	



STEPENASTA BURGIJA HSS

HSS



Br.	Specifikacija	10
20487	Ø 4 - 20 mm 9 stepena	
20488	Ø 5 - 35 mm 13 stepena	10
20494	Ø 4 - 32 mm 15 stepena	10
20493	Ø 7 - 40,5 mm 13 stepena	1



STEPENASTA BURGIJA HSS
KOMPLET

HSS



3x

Br.	Specifikacija	1
20496	Ø 4 - 12, 4 - 20, 4 - 32 mm	





FESTA
KOMPLET ZA VADJENJE

- ∅ 4 mm ∅ 11 mm
- ∅ 4,5 mm ∅ 15 mm
- ∅ 6,5 mm ∅ 19 mm
- ∅ 7,5 mm ∅ 24 mm

8x

Br.	Specifikacija	
20387		5



FESTA
KOMPLET ZA VADJENJE

- ∅ 4 mm
- ∅ 4,5 mm
- ∅ 6 mm
- ∅ 7,5 mm
- ∅ 11 mm

5x

Br.	Specifikacija	
20386		10



KOMPLET ZA VADJENJE

- ∅ 4 mm
- ∅ 4,5 mm
- ∅ 6 mm
- ∅ 7,5 mm
- ∅ 11 mm

5x

Br.	Specifikacija	
20385		10



DRŽAČ UREZNICA

Br.	Specifikacija	
20397	M3 - M8	10



FESTA
DRŽAČ NAREZNICA

DIN 225

Br.	Specifikacija	
20396	25 x 9 mm	10



FESTA
DRŽAČ UREZNICA

DIN 1814

Br.	Specifikacija	
20394	M5 - M20	10
20395	1 - 1/2", M3 - M12	10



FESTA
KOMPLET UREZNICA I NAREZNICA

32x

Br.	Specifikacija	
20391	M 3, 4, 5, 6, 8, 10, 12 mm	1



FESTA
KOMPLET UREZNICA

21x

Br.	Specifikacija	
20390	M 3, 4, 5, 6, 8, 10, 12 mm	1

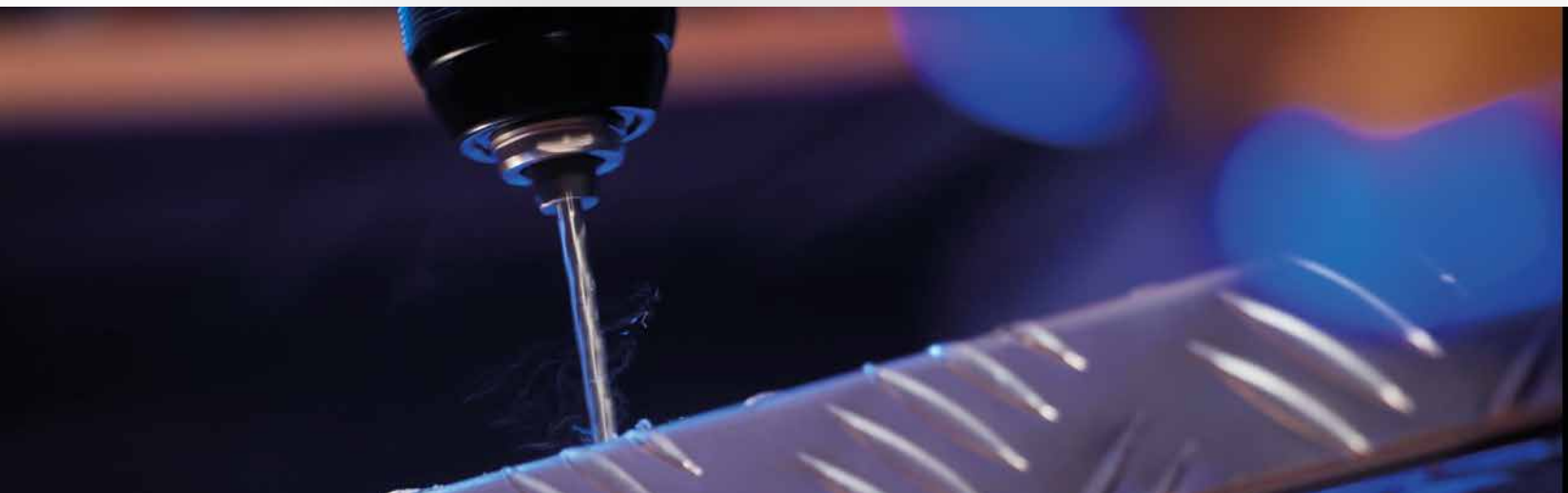

NEW

FESTA

FORSTNER BURGIIJA

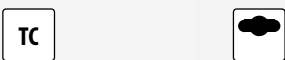

Br.	Specifikacija	
21531	Ø 15 mm	1
21532	Ø 20 mm	1
21533	Ø 25 mm	1
21534	Ø 30 mm	1
21535	Ø 35 mm	1
21536	Ø 40 mm	1



FESTA



FESTA

BURGIJA ZA DRVO



Br.	Specifikacija	
20980	Ø 6 x 230 mm	1
20957	Ø 6 x 300 mm	1
20981	Ø 8 x 230 mm	1
20958	Ø 8 x 300 mm	1
20982	Ø 10 x 230 mm	1
20896	Ø 10 x 300 mm	1
20913	Ø 10 x 450 mm	1
20983	Ø 12 x 230 mm	1
20897	Ø 12 x 300 mm	1
20915	Ø 12 x 450 mm	1
20920	Ø 12 x 600 mm	1
20898	Ø 14 x 300 mm	1
20916	Ø 14 x 450 mm	1
20921	Ø 14 x 600 mm	1

Br.	Specifikacija	
20984	Ø 16 x 230 mm	1
20899	Ø 16 x 300 mm	1
20917	Ø 16 x 450 mm	1
20922	Ø 16 x 600 mm	1
20918	Ø 18 x 450 mm	1
20923	Ø 18 x 600 mm	1
20919	Ø 20 x 450 mm	1
20924	Ø 20 x 600 mm	1
20724	Ø 22 x 450 mm	1
20725	Ø 24 x 450 mm	1
20726	Ø 26 x 450 mm	1
20727	Ø 28 x 450 mm	1
20728	Ø 30 x 450 mm	1

FESTA

BURGIJA ZA DRVO



5x

Br.	Specifikacija	
20911	Ø 8, 10, 12, 14, 16 x 460 mm	10



FESTA

BURGIJA ZA DRVO



6x

Br.	Specifikacija	
20912	Ø 6, 8, 10, 12, 16, 20 x 230 mm	10



BURGIJA ZA DRVO



Br.	Specifikacija	
20729	Ø 6 x 400 mm	1
20731	Ø 8 x 400 mm	1
20736	Ø 8 x 600 mm	1
20730	Ø 10 x 400 mm	1
20737	Ø 10 x 600 mm	1



Br.	Specifikacija	
20732	Ø 12 x 400 mm	1
20738	Ø 12 x 600 mm	1
20733	Ø 14 x 400 mm	1
20739	Ø 14 x 600 mm	1

Br.	Specifikacija	
20734	Ø 16 x 400 mm	1
20740	Ø 16 x 600 mm	1
20735	Ø 18 x 400 mm	1
20741	Ø 18 x 600 mm	1

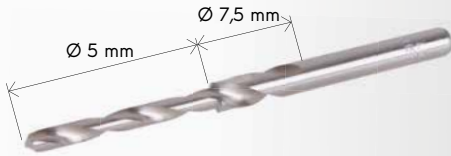

FESTA

DVOSTEPENA BURGIIJA



Br.	Specifikacija	
20210	Ø 7,5, 5 mm	1



BURGIJA ZA DRVO



Br.	Specifikacija	
21440	Ø 4 x 75 mm	1
21441	Ø 5 x 85 mm	1
21442	Ø 6 x 90 mm	1
21443	Ø 7 x 105 mm	1
21444	Ø 8 x 115 mm	1
21445	Ø 9 x 120 mm	1
21446	Ø 10 x 120 mm	1



FREZA TITAN HSS



Br.	Specifikacija	
20460	Ø 6 mm	50



BURGIJA ZA DRVO KOMPLET



Br.	Specifikacija	
20910	8 kom Ø 3, 4, 5, 6, 7, 8, 9, 10 mm	10
20905	5 kom Ø 4, 5, 6, 8, 10 mm	10



FREZER ZA DRVO



5x

Br.	Specifikacija	
21530	Ø 15, 20, 25, 30, 35 mm Ø 8 mm 20	20



FREZE KOMPLET



6x

Br.	Specifikacija	
20450	Ø 3, 4, 5, 6, 6.5, 8 mm	20

BURGIJA ZA DRVO KOMPLET



6x

Br.	Specifikacija	
20901	Ø 10, 12, 16, 18, 20, 25 mm	20



20



RUČNA BURGIIJA SET

HOBBY

4x

Br.	Specifikacija	
20381	Ø 2, 3, 4, 5 mm	20





FESTA

**TESTERA KRUŽNA
KOMPLET**

- Ø 19 mm
- Ø 22 mm
- Ø 25,5 mm
- Ø 36 mm
- Ø 44 mm
- Ø 51 mm
- Ø 60 mm
- Ø 67 mm
- Ø 76 mm
- Ø 82 mm
- Inbus
- 2x glava



12x

Br.	Specifikacija	
24712	6 tpi	20



FESTA

**TESTERA KRUŽNA
KOMPLET**

- Ø 64 mm
- Ø 73 mm
- Ø 89 mm
- Ø 102 mm
- Ø 127 mm
- Glava
- Inbus



8x

Br.	Specifikacija	
24706	6 tpi	20



FESTA

**KRUNA ZA RUPE
PODESIVO**

Ø 19 - 127 mm



Br.	Specifikacija	
24415	Ø 19 - 127 mm	maksimalna dubina 29 mm

FESTA

**TESTERA KRUŽNA
KOMPLET**



Br.	Specifikacija	
24715	1' Ø 67 mm	6 tpi
24713	1' Ø 73 mm	6 tpi
24714	1' Ø 102 mm	6 tpi
24720	1' Ø 152 mm	6 tpi



TESTERA KRUŽNA



Br.	Specifikacija	
24721	1' Ø 26, 32, 38, 45, 50, 56, 63 mm	10
24722	2' Ø 26, 32, 38, 45, 50, 56, 63 mm	10

**PODESIVO SEČIVO
ZA RUPE**



Br.	Specifikacija	
24716	Ø 30 - 120 mm	5

FESTA

TURPIJICE ROTACIONE

M14

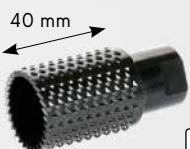

Br.	Specifikacija	
21807	Ø 30 mm / 60 mm	1

FESTA

TURPIJICE ROTACIONE

M14



Br.	Specifikacija	
21808	Ø 30 mm / 105 mm	10



TURPIJICE ROTACIONE

5x



Br. 21541 Specifikacija 25



BRUSNI KAMEN

5x



Br. 21540 Specifikacija 12
Ø 3 mm, 6 mm

KOMPLET ROTACIONIH BRUSEVA

190x



Br. 24755 Specifikacija 5

KOMPLET ROTACIONIH BRUSEVA

150x



Br. 24756 Specifikacija 10



FREZER ZA DRVO



5x



Br. 21450 Specifikacija 10
Ø 8 mm



FREZER ZA DRVO



12x

Br. 21451 Specifikacija 10
Ø 8 mm



FREZER ZA DRVO



24x

Br. 21452 Specifikacija 1
Ø 8 mm



FREZER ZA DRVO



35x



Br. 21453 Specifikacija 1
Ø 8 mm



FREZER ZA DRVO



59x



Br. 21454 Specifikacija 1
Ø 8 mm

FESTA

BURGIJA VIDIJUM

DIN 8039



Burgija sa 2 oštrice



Br.	Specifikacija	A mm	B mm	
20673	Ø 3 mm	60	30	100
20674	Ø 4 mm	75	40	100
20675	Ø 5 mm	85	50	100
20676	Ø 6 mm	100	60	100
20677	Ø 6 mm	200	160	50
20685	Ø 6 mm	300	260	50
20678	Ø 8 mm	120	75	50
20686	Ø 8 mm	200	155	50

Br.	Specifikacija	A mm	B mm	
20687	Ø 8 mm	300	255	25
20688	Ø 8 mm	400	340	25
20680	Ø 10 mm	120	70	50
20690	Ø 10 mm	200	150	50
20691	Ø 10 mm	300	250	25
20692	Ø 10 mm	400	340	25
20682	Ø 12 mm	150	100	50
20694	Ø 12 mm	300	250	25

Br.	Specifikacija	A mm	B mm	
20696	Ø 12 mm	400	340	25
20684	Ø 14 mm	150	90	25
	redukce Ø 10 mm			
20697	Ø 14 mm	300	240	5
	redukce Ø 10 mm			
20698	Ø 14 mm	400	340	15
	redukce Ø 10 mm			

FESTA

BURGIJA VIDIJUM SDS+

SDS+

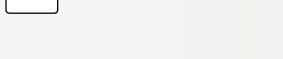

Burgija sa 2 oštrice



Br.	Specifikacija	A mm	B mm	
20855	Ø 14 mm	160	75	

Br.	Specifikacija	A mm	B mm	
				25

Br.	Specifikacija	A mm	B mm	
				25

FESTA

BURGIJA VIDIJUM SDS+

SDS+

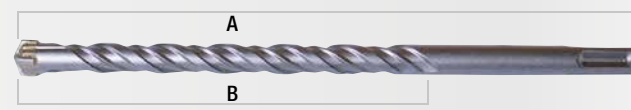

Burgija sa 4 oštrice-bolja upotreba i vek trajanja



Br.	Specifikacija	A mm	B mm	
20748	Ø 6 mm	110	40	50
20749	Ø 6 mm	160	90	50
20750	Ø 6 mm	210	140	50
20751	Ø 6 mm	260	190	50
20861	Ø 6,5 mm	230	160	50
20862	Ø 6,5 mm	300	230	50
20752	Ø 8 mm	110	40	50
20753	Ø 8 mm	160	90	50
20754	Ø 8 mm	210	140	50
20755	Ø 8 mm	260	190	50
20825	Ø 8 mm	350	280	50
20756	Ø 10 mm	160	90	50
20757	Ø 10 mm	210	140	50
20758	Ø 10 mm	260	190	50
20759	Ø 10 mm	350	280	50
20760	Ø 10 mm	450	380	50
20761	Ø 10 mm	600	530	50
20762	Ø 10 mm	1000	930	50
20764	Ø 12 mm	160	80	50
20765	Ø 12 mm	210	130	50
20766	Ø 12 mm	260	180	50
20767	Ø 12 mm	350	270	50

Br.	Specifikacija	A mm	B mm	
20768	Ø 12 mm	460	380	50
20769	Ø 12 mm	600	520	25
20770	Ø 12 mm	1000	920	25
20771	Ø 14 mm	160	80	25
20772	Ø 14 mm	260	180	25
20773	Ø 14 mm	350	270	25
20774	Ø 14 mm	460	380	25
20775	Ø 14 mm	600	520	25
20776	Ø 14 mm	1000	920	30
20777	Ø 16 mm	160	80	25
20778	Ø 16 mm	210	130	25
20779	Ø 16 mm	260	180	25
20780	Ø 16 mm	350	270	25
20781	Ø 16 mm	460	380	25
20782	Ø 16 mm	600	520	30
20783	Ø 16 mm	1000	920	25
20784	Ø 18 mm	260	180	25
20785	Ø 18 mm	450	370	25
20786	Ø 18 mm	600	520	32
20787	Ø 18 mm	1000	920	20
20788	Ø 20 mm	450	370	20
20789	Ø 20 mm	600	520	20

Br.	Specifikacija	A mm	B mm	
20790	Ø 20 mm	800	720	25
20791	Ø 20 mm	1000	920	10
20792	Ø 22 mm	450	365	20
20793	Ø 22 mm	600	520	20
20794	Ø 22 mm	800	715	20
20795	Ø 22 mm	1000	920	10
20796	Ø 24 mm	450	365	10
20797	Ø 24 mm	600	520	20
20798	Ø 24 mm	800	715	10
20799	Ø 24 mm	1000	920	10
20870	Ø 26 mm	450	370	10
20871	Ø 26 mm	650	570	20
20872	Ø 26 mm	800	720	10
20873	Ø 26 mm	1000	920	10
20874	Ø 28 mm	450	365	10
20875	Ø 28 mm	600	565	20
20876	Ø 28 mm	800	715	10
20877	Ø 28 mm	1000	915	10
20878	Ø 30 mm	450	365	10
20879	Ø 30 mm	600	565	20
20880	Ø 30 mm	800	715	10
20881	Ø 30 mm	1000	915	10

FESTA

BURGIJA VIDIJUM SDS MAX

SDS MAX

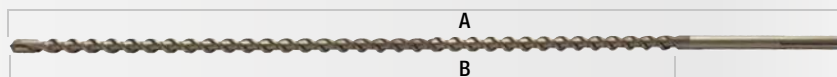

Burgija sa 4 oštrice-bolja upotreba i vek trajanja



Br.	Specifikacija	A mm	B mm	
20508	Ø 16 mm	550	395	5
20510	Ø 18 mm	550	395	5
20520	Ø 18 mm	800	650	5
20511	Ø 20 mm	550	395	5
20521	Ø 20 mm	800	650	5

Br.	Specifikacija	A mm	B mm	
20512	Ø 22 mm	550	395	5
20522	Ø 22 mm	800	650	5
20513	Ø 24 mm	550	395	5
20523	Ø 24 mm	800	650	5
20514	Ø 28 mm	550	395	5

Br.	Specifikacija	A mm	B mm	
20524	Ø 28 mm	800	650	5
20515	Ø 30 mm	550	395	5
20525	Ø 30 mm	800	650	5
20516	Ø 40 mm	550	395	2
20526	Ø 40 mm	800	650	1

BURGIJA KOMPLET SDS+

5x SDS+



Br.	Specifikacija		
20890	Ø 5, 6, 8, 10, 12 mm	160 mm	25



BURGIJA KOMPLET SDS+

6x SDS+



Br.	Specifikacija		
20891	Ø 5, 6, 8 mm Ø 8, 10, 12 mm	110 mm 160 mm	25



BURGIJA VIDIJUM KOMPLET

6x DIN 8039



Br.	Specifikacija		
20895	Ø 5, 6, 8, 10, 12 mm		25



BURGIJA VIDIJUM KOMPLET



Br.	Specifikacija		
20805	5 kom Ø 4 - 10 mm		10
20820	8 kom Ø 3 - 10 mm		10



FESTA

SDS+ KOMPLET

SDS+

4x



Br.	Specifikacija		
20954	250 mm		1



REKLAMNA POLICA

Br.	Specifikacija		
20999			1

62,5 cm 89 cm 44 cm

FESTA

SDS+ KOMPLET

- 2 x špic
- 3 x sekač
- 12 x burgija Ø 5-12 mm

17x SDS+



Br.	Specifikacija		
20952			1



FESTA

SDS+ KOMPLET

- 1 x špic 250 mm
- 1 x sekač 22 x 250 mm
- 1 x sekač 20 x 250 mm

- Ø 5 x 110 mm
- Ø 6 x 110 mm
- Ø 8 x 160 mm
- Ø 10 x 160 mm
- Ø 12 x 160 mm
- Ø 14 x 210 mm
- Ø 16 x 210 mm
- Ø 18 x 310 mm
- Ø 20 x 450 mm

12x SDS+



Br.	Specifikacija		
20950			5



FESTA

SEKAČ ZA UDARNU BUŠILICU

SDS+



Br.	Specifikacija		
20996	250 x 100 mm		1



NEW



FESTA

SEKAČ ZA UDARNU BUŠILICU

SDS+

Br.	Specifikacija	
20997	445 x 130 mm	1

NEW

FESTA

SEKAČ ZA UDARNU BUŠILICU

SDS MAX

Br.	Specifikacija	
20932	450 x 100 mm	1

FESTA

SEKAČ ZA UDARNU BUŠILICU 15°

SDS+

Br.	Specifikacija	
20936	40 x 250 mm	5

FESTA

SEKAČ ZA UDARNU BUŠILICU

SDS+

Br.	Specifikacija	
20948	20 x 250 mm	25
20990	20 x 400 mm	25
20949	40 x 250 mm	25
20991	40 x 400 mm	25

FESTA

SEKAČ ZA UDARNU BUŠILICU

SDS MAX

Br.	Specifikacija	
20940	25 x 280 mm	5
20941	40 x 280 mm	5
20942	75 x 280 mm	5
20943	25 x 400 mm	5
20944	40 x 400 mm	5
20945	25 x 600 mm	5
20946	50 x 600 mm	5

FESTA

ŠPIC ZA UDARNU BUŠILICU

SDS+

Br.	Specifikacija	
20947	250 mm	25
20992	400 mm	25

FESTA

ŠPIC ZA UDARNU BUŠILICU

SDS MAX

Br.	Specifikacija	
20937	Ø 18 x 280 mm	5
20938	Ø 18 x 400 mm	5
20939	Ø 18 x 600 mm	2

FESTA

DLETO SDS+

SDS+

Br.	Specifikacija	
20956	22 x 250 mm	25

FESTA

SDS+ KRUNA ZA RUPE

• stezna glava za burgije 24730, 24731 a 24732

SDS+

Br.	Specifikacija	
24719	Ø 67 mm	1
24717	Ø 73 mm	1
24723	Ø 80 mm	1
24718	Ø 100 mm	1
24757	Ø 115 mm	1
24758	Ø 125 mm	1
24759	Ø 150 mm	1



FESTA

STEZNA GLAVA ZA BURGIJE

SDS MAX

Br.	Specifikacija	
24730	180 mm	1

FESTA

STEZNA GLAVA ZA BURGIJE

SDS+

Br.	Specifikacija	
24731	300 mm	1
24732		1





FESTA

KOMPLET KRUNA ZA IZREZIVANJE RUPA



6x



Br.	Specifikacija	
24745	Ø 33, 53, 67, 73 mm + nosač, burgija	1

FESTA

KOMPLET KRUNA ZA IZREZIVANJE RUPA



8x



Br.	Specifikacija	
24747	Ø 33, 53, 67, 73, 83 mm Nosač, burgija, nagibno sečivo	1

FESTA

KRUNA ZA IZREZIVANJE RUPA

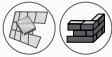

Br.	Specifikacija	
24735	Ø 33 mm	1
24736	Ø 43 mm	1
24737	Ø 53 mm	1
24738	Ø 67 mm	1
24739	Ø 73 mm	1
24740	Ø 83 mm	1
24741	Ø 103 mm	1



FESTA

KRUNA ZA IZREZIVANJE RUPA

3x



Br.	Specifikacija	
24746	Ø 103 mm + nosač, burgija	1

FESTA

BURGIJA

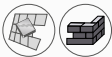

Br.	Specifikacija	
24749		50



FESTA

NOSAČ



Br.	Specifikacija	
24748	Ø 33 - 83 mm	10
24743	Ø 33 - 103 mm	10



FESTA

KRUNA ZA IZREZIVANJE RUPA KARBID

· Za bušenje stakla i keramike
· Neophodno hlađenje



Br.	Specifikacija	
24770	Ø 4 mm	1
24771	Ø 6 mm	1
24772	Ø 8 mm	1
24773	Ø 10 mm	1
24774	Ø 12 mm	1



TESTERA KRUŽNA ZA PLOČICE

Br.	Specifikacija	
24726	Ø 20-95mm	1



TESTERA KRUŽNA ZA PLOČICE

Br.	Specifikacija	
24725	Ø 20-95mm	10



FESTA

NAGIBNO SEČIVO



Br.	Specifikacija	
22200	160 mm	20



FESTA

NAGIBNO SEČIVO

· Za brušenje opeka



Br.	Specifikacija	
22201	200 mm dvojí asperity	20





DIJAMANTNA KRUNA ZA IZREZIVANJE RUPA

- Ø 6 mm
- Ø 8 mm
- Ø 10 mm
- Ø 12 mm
- Ø 20 mm
- Ø 28 mm
- Ø 35 mm
- Ø 45 mm
- Ø 55 mm
- Ø 68 mm

rezn / brusna ploča Ø 125 mm x 2,0 mm Ø 22,2 mm
 rezn ploča Ø 125 mm x 1,2 mm Ø 22,2 mm

dijamantna krna brusna Ø 0 - 50 mm
 dijamantski abrazivni sundjer 90 x 55 mm P60

13x M14

- Keramičke pločice
- Mermer
- Granit

• Upotreba bez vodenog hlađenja



Br.	Specifikacija	
24652		1



DIJAMANTNA KRUNA ZA IZREZIVANJE RUPA

M14

- Keramičke pločice
- Mermer
- Granit

• Upotreba bez vodenog hlađenja



Br.	Specifikacija	
24620	Ø 6 mm	M14
24621	Ø 8 mm	M14
24622	Ø 10 mm	M14
24623	Ø 12 mm	M14
24624	Ø 14 mm	M14
24627	Ø 20 mm	M14
24630	Ø 28 mm	M14
24633	Ø 35 mm	M14
24636	Ø 45 mm	M14
24638	Ø 55 mm	M14
24640	Ø 68 mm	M14
24642	NEW Ø 72 mm	M14
24643	Ø 75 mm	M14



DIJAMANTNA KRUNA ZA IZREZIVANJE RUPA

- Ø 6 mm
- Ø 8 mm
- Ø 10 mm
- Ø 20 mm
- Ø 35 mm
- Ø 45 mm
- Ø 55 mm
- Ø 68 mm

8x M14

- Keramičke pločice
- Mermer
- Granit

• Upotreba bez vodenog hlađenja



Br.	Specifikacija	
24651		1



DIJAMANTSKA KRUNA ZA BRUŠENJE

M14

- Keramičke pločice
- Mermer
- Granit

• Upotreba bez vodenog hlađenja



Br.	Specifikacija	
24795	Ø 20 / 50 mm	1
24797	Ø 6 / 50 mm	1
24799	Ø 10 / 50 mm	1



DIJAMANTNA KRUNA BRUSNA

M14

- Keramičke pločice
- Mermer
- Granit

• Upotreba bez vodenog hlađenja



Br.	Specifikacija	
24775	NEW Ø 2 - 35 mm	1
24777	Ø 2 - 75 mm	1
24778	Ø 2 - 50 mm	1



DIJAMANTNA KRUNA BRUSNA



M14

- Keramičke pločice
- Mermer
- Granit

Upotreba bez vodenog hlađenja



Br.	Specifikacija	1
24779	Ø 20 - 48 mm	1



DIJAMANTSKA KRUNA ZA BRUŠENJE



NEW

M14

- Keramičke pločice
- Mermer
- Granit

Upotreba bez vodenog hlađenja



Br.	Specifikacija	1
24663	Ø 50 mm	1



DIJAMANTNA KRUNA ZA IZREZIVANJE RUPA



M14

- Keramičke pločice
- Mermer
- Granit

Upotreba bez vodenog hlađenja



Br.	Specifikacija	učyt	1	Br.	Specifikacija	učyt	1
24760	Ø 6 mm	M14	1	24766	Ø 35 mm	M14	1
24761	Ø 8 mm	M14	1	24776	Ø 40 mm	M14	1
24762	Ø 10 mm	M14	1	24767	Ø 45 mm	M14	1
24763	Ø 12 mm	M14	1	24791	Ø 50 mm	M14	1
24764	Ø 14 mm	M14	1	24768	Ø 53 mm	M14	1
24670	Ø 16 mm	M14	1	24792	Ø 60 mm	M14	1
24671	Ø 18 mm	M14	1	24793	Ø 65 mm	M14	1
24790	Ø 20 mm	M14	1	24769	Ø 68 mm	M14	1
24672	Ø 22 mm	M14	1	24794	Ø 75 mm	M14	1
24673	Ø 25 mm	M14	1	24796	Ø 83 mm	M14	1
24765	Ø 28 mm	M14	1	24677	Ø102 mm	M14	1
24674	Ø 30 mm	M14	1	24676	Ø 110 mm	M14	1
24675	Ø 32 mm	M14	1	24678	Ø125 mm	M14	1



DIJAMANTSKA KRUNA ZA BRUŠENJE



NEW

M14

- Keramičke pločice
- Mermer
- Granit

Upotreba bez vodenog hlađenja



Br.	Specifikacija	1
24661	Ø 50 mm	1



DIJAMANTNA KRUNA ZA IZREZIVANJE RUPA



- Ø 8 mm
- Ø 10 mm
- Ø 14 mm
- Ø 22 mm
- Ø 32 mm
- Ø 40 mm
- Ø 68 mm

7x M14

- Keramičke pločice
- Mermer
- Granit

Upotreba bez vodenog hlađenja



Br.	Specifikacija	1
24650		1



DIJAMANTNA KRUNA ZA IZREZIVANJE RUPA

- Keramičke pločice
- Mermer
- Granit



Br.	Specifikacija	1
24700	Ø 6 mm	1
24701	Ø 8 mm	1
24702	Ø 10 mm	1
24703	Ø 12 mm	1
24704	Ø 14 mm	1
24705	Ø 20 mm	1



FESTA

VOSAK ZA HLAĐENJE
ZA DIJAMANTSKU
TESTERU



Br.	Specifikacija	
24710	30 ml	1

FESTA

DIJAMANTNA KRUNA
ZA IZREZIVANJE
RUPA



6x

- Keramičke pločice
- Mermer
- Granit

Br.	Specifikacija	
24798	Ø 6, 8, 10, 12, 14, 20 mm	1



FESTA

DIJAMANTSKA
REZNA, BRUSNA
PLOČA

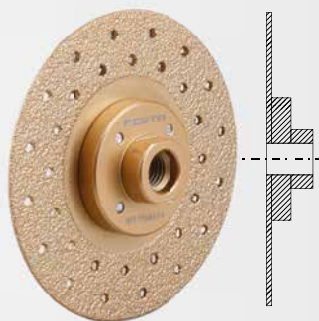

M14

- Keramičke pločice
- Mermer
- Granit

- Upotreba bez vodenog hlađenja

Br.	Specifikacija	
24655	Ø 115 mm M14	1

FESTA

DIJAMANTSKA
BRUSNA PLOČA

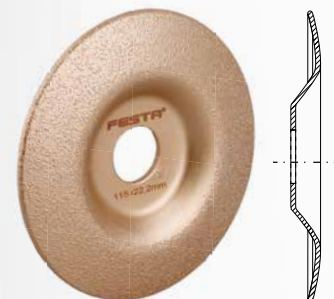

- Keramičke pločice
- Mermer
- Granit

- Upotreba bez vodenog hlađenja

Br.	Specifikacija	
24658	Ø 115 mm Ø 22,2 mm	1

FESTA

BURGIJE ZA STAKLO I KERAMIKU

TiN 1/4"

- Keramičke pločice
- Mermer
- Granit

Br.	Specifikacija	
24780	Ø 4 mm	40
24781	Ø 5 mm	40
24782	Ø 6 mm	40
24783	Ø 8 mm	40
24784	Ø 10 mm	40
24785	Ø 12 mm	40
24786	Ø 14 mm	1
24787	Ø 16 mm	1
24788	Ø 18 mm	1
24789	Ø 20 mm	1



FESTA

BURGIJE ZA STAKLO
I KERAMIKU - KOMPLET

- Ø 4 mm
- Ø 5 mm
- Ø 6 mm
- Ø 8 mm
- Ø 10 mm

5x

- Keramičke pločice
- Mermer
- Granit

- Upotreba bez vodenog hlađenja

Br.	Specifikacija	
24734		1



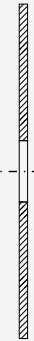

DIJAM. PLOČA REZNA / BRUSNA

- Keramičke pločice
- Mermer
- Granit
- Upotreba bez vodenog hlaenja



Br.	Specifikacija		
21230	Ø 115 mm x 1,8 mm	Ø 22,2 mm	1
21231	Ø 125 mm x 2,0 mm	Ø 22,2 mm	1



DIJAM. REZNA PLOČA TURBO EXTREME

- Keramičke pločice
- Mermer
- Granit
- Upotreba bez vodenog hlaenja

Br.	Specifikacija		
21205	Ø 125 mm x 2,0 mm	Ø 22,2 mm	1
21209	Ø 230 mm x 2,6 mm	Ø 22,2 mm	1



DIJAM. REZNA PLOČA

- Keramičke pločice
- Mermer
- Granit
- Upotreba bez vodenog hlaenja

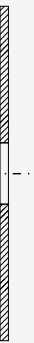
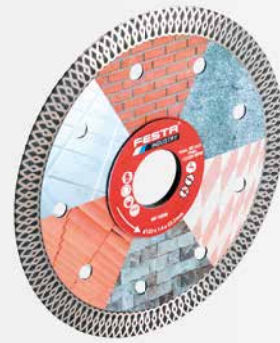

DIJAM. REZ. PLOČA

- Keramičke pločice
- Mermer
- Granit
- Upotreba bez vodenog hlaenja

Br.	Specifikacija		
21200	Ø 115 mm 1,4 mm	Ø 22,2 mm	1
21201	Ø 125 mm 1,4 mm	Ø 22,2 mm	1
21204	Ø 200 mm 1,8 mm	Ø 25,4 mm	1
21203	Ø 230 mm 1,8 mm	Ø 22,2 mm	1



FESTA

DIJAM. REZ. PLOČA SEGMENT

Br.	Specifikacija		
21311	Ø 115 mm	Ø 22,2 mm	1
21312	Ø 125 mm	Ø 22,2 mm	1
21315	Ø 150 mm	Ø 22,2 mm	1
21318	Ø 180 mm	Ø 22,2 mm	1
21323	Ø 230 mm	Ø 22,2 mm	1
21324	Ø 300 mm	Ø 25,4 mm	1
21327	Ø 350 mm	Ø 25,4 mm	1
21326	Ø 400 mm	Ø 25,4 mm	1



FESTA

DIJAM. REZ. PLOČA TURBO

Br.	Specifikacija		
21411	Ø 115 mm	Ø 22,2 mm	1
21412	Ø 125 mm	Ø 22,2 mm	1
21415	Ø 150 mm	Ø 22,2 mm	1
21418	Ø 180 mm	Ø 22,2 mm	1
21423	Ø 230 mm	Ø 22,2 mm	1
21424	Ø 300 mm	Ø 25,4 mm	1



FESTA

DIJAM. REZ. PLOČA PUNE

Br.	Specifikacija		
21210	Ø 110 mm	Ø 22,2 mm	1
21211	Ø 115 mm	Ø 22,2 mm	1
21212	Ø 125 mm	Ø 22,2 mm	1
21215	Ø 150 mm	Ø 22,2 mm	1
21218	Ø 180 mm	Ø 22,2 mm	1
21219	Ø 180 mm	Ø 25,4 mm	1
21220	Ø 200 mm	Ø 25,4 mm	1
21223	Ø 230 mm	Ø 22,2 mm	1
21224	Ø 300 mm	Ø 25,4 mm	1



FESTA
INDUSTRY

DIJAM. REZ. PLOČA SEGMENT - UNIVERZALNI



Br.	Specifikacija		
21301	Ø 125 mm	Ø 22,2 mm	1,5 mm
21303	Ø 230 mm	Ø 22,2 mm	1,8 mm



FESTA

DIJAM. REZ. PLOČA



Br.	Specifikacija		
21195	Ø 125 x	22,2 mm	1



6 mm



DIJAM. REZ. PLOČA PUNE

Br.	Specifikacija		
21010	Ø 110 mm	Ø 22,2 mm	1
21011	Ø 115 mm	Ø 22,2 mm	1
21012	Ø 125 mm	Ø 22,2 mm	1
21015	Ø 150 mm	Ø 22,2 mm	1
21018	Ø 180 mm	Ø 22,2 mm	1
21023	Ø 230 mm	Ø 22,2 mm	1



DIJAM. REZ. PLOČA SEGMENT

Br.	Specifikacija		
21110	Ø 110 mm	Ø 22,2 mm	1
21111	Ø 115 mm	Ø 22,2 mm	1
21112	Ø 125 mm	Ø 22,2 mm	1
21115	Ø 150 mm	Ø 22,2 mm	1
21118	Ø 180 mm	Ø 22,2 mm	1
21123	Ø 230 mm	Ø 22,2 mm	1



DIJAM. REZ. PLOČA TURBO

Br.	Specifikacija		
21130	Ø 110 mm	Ø 22,2 mm	1
21135	Ø 115 mm	Ø 22,2 mm	1
21140	Ø 125 mm	Ø 22,2 mm	1
21150	Ø 150 mm	Ø 22,2 mm	1
21180	Ø 180 mm	Ø 22,2 mm	1
21190	Ø 230 mm	Ø 22,2 mm	1





FESTA

DIJAM. BRUSNA PLOČA



Br.	Specifikacija		
21435	Ø 115 mm	Ø 22,2 mm	1
21436	Ø 125 mm	Ø 22,2 mm	1
21437	Ø 150 mm	Ø 22,2 mm	1



FESTA

DIJAM. BRUSNA PLOČA



Br.	Specifikacija		
21430	Ø 115 mm	Ø 22,2 mm	1
21431	Ø 125 mm	Ø 22,2 mm	1
21432	Ø 150 mm	Ø 22,2 mm	1



FESTA

DIJAM. BRUSNA PLOČA



Br.	Specifikacija		
21425	Ø 100 mm	Ø 22,2 mm	1
21426	Ø 115 mm	Ø 22,2 mm	1
21427	Ø 125 mm	Ø 22,2 mm	1
21428	Ø 150 mm	Ø 22,2 mm	1



FESTA
INDUSTRY

REZNA PLOČA ZA METAL



Br.	Specifikacija		
22258	Ø 115 mm	Ø 22,2 mm x 0,8 mm	25
22260	Ø 115 mm	Ø 22,2 mm x 1 mm	25
22263	Ø 115 mm	Ø 22,2 mm x 1,6 mm	25
22264	Ø 115 mm	Ø 22,2 mm x 2 mm	25
22259	Ø 125 mm	Ø 22,2 mm x 0,8 mm	25
22266	Ø 125 mm	Ø 22,2 mm x 1 mm	25
22269	Ø 125 mm	Ø 22,2 mm x 1,6 mm	25
22270	Ø 125 mm	Ø 22,2 mm x 2 mm	25
22273	Ø 150 mm	Ø 22,2 mm x 1,6 mm	25
22274	Ø 150 mm	Ø 22,2 mm x 2 mm	25
22275	Ø 150 mm	Ø 22,2 mm x 2,5 mm	25
22277	Ø 180 mm	Ø 22,2 mm x 2 mm	25
22280	Ø 230 mm	Ø 22,2 mm x 2 mm	25
22281	Ø 230 mm	Ø 22,2 mm x 2,5 mm	25

FESTA
INDUSTRY

REZNA PLOČA ZA ALUMINIJUM



Br.	Specifikacija		
22285	Ø 115 mm	Ø 22,2 mm x 1 mm	25
22286	Ø 125 mm	Ø 22,2 mm x 1 mm	25

FESTA
INDUSTRY

REZNA PLOČA ZA KAMEN



Br.	Specifikacija		
22294	Ø 230 mm	Ø 22,2 mm x 3 mm	25

FESTA

REZNA PLOČA ZA METAL



Br.	Specifikacija			
22211	Ø 115 mm	Ø 22,2 mm x 1 mm	INOX	50
22212	Ø 115 mm	Ø 22,2 mm x 1,2 mm	INOX	50
22225	Ø 125 mm	Ø 22,2 mm x 1 mm	INOX	50
22217	Ø 125 mm	Ø 22,2 mm x 1,2 mm	INOX	50

FESTA

REZNA PLOČA ZA METAL

10x



Br.	Specifikacija			
22228	Ø 115 mm	Ø 22,2 mm x 1 mm	INOX	6
22229	Ø 125 mm	Ø 22,2 mm x 1,2 mm	INOX	6

FESTA

REZNA PLOČA ZA METAL



Br.	Specifikacija			
22251	Ø 115 mm	Ø 22,2 mm x 1,6 mm		50
22215	Ø 115 mm	Ø 22,2 mm x 2 mm		50
22216	Ø 115 mm	Ø 22,2 mm x 2,5 mm		50
22252	Ø 125 mm	Ø 22,2 mm x 1,6 mm		25
22218	Ø 125 mm	Ø 22,2 mm x 2,5 mm		25
22219	Ø 150 mm	Ø 22,2 mm x 1,2 mm		25
22253	Ø 150 mm	Ø 22,2 mm x 1,6 mm		50
22220	Ø 150 mm	Ø 22,2 mm x 2,5 mm		50
22254	Ø 180 mm	Ø 22,2 mm x 1,6 mm		50
22222	Ø 180 mm	Ø 22,2 mm x 2,5 mm		25
22255	Ø 230 mm	Ø 22,2 mm x 1,6 mm		25
22224	Ø 230 mm	Ø 22,2 mm x 2,5 mm		25

FESTA

BRUSNA PLOČA ZA METAL



Br.	Specifikacija			
22240	Ø 115 mm	Ø 22,2 mm x 6,4 mm		25
22242	Ø 125 mm	Ø 22,2 mm x 6,4 mm		25
22244	Ø 150 mm	Ø 22,2 mm x 6,4 mm		25
22246	Ø 180 mm	Ø 22,2 mm x 6,4 mm		25
22248	Ø 230 mm	Ø 22,2 mm x 6,4 mm		25

FESTA

DIJAŃ. REZ. PLOČA ZA METAL



Br.	Specifikacija			
21306	Ø 125 mm	Ø 22,2 mm x 1,3 mm		25
21308	Ø 230 mm	Ø 22,2 mm x 1,8 mm		5

FESTA

REZNA PLOČA ZA KAMEN



Br.	Specifikacija			
22230	Ø 115 mm	Ø 22,2 mm x 2,5 mm		50
22232	Ø 125 mm	Ø 22,2 mm x 2,5 mm		50
22234	Ø 150 mm	Ø 22,2 mm x 2,5 mm		25
22236	Ø 180 mm	Ø 22,2 mm x 2,5 mm		25
22238	Ø 230 mm	Ø 22,2 mm x 2,5 mm		25

FESTA

REZNA PLOČA UNIVERZALNI KARBID



Br.	Specifikacija			
21192	Ø 125 mm	Ø 22,2 mm x 1,8 mm		25
21194	Ø 230 mm	Ø 22,2 mm x 2,5 mm		5

FESTA

DISK ZA
BRUŠENJE DRVETA



Br.	Specifikacija			
21806	Ø 125 mm	Ø 22,2 mm		1

20 mm



FESTA

DISK ZA
BRUŠENJE DRVETA
SREDNJE GRUBO



Br.	Specifikacija			
21802	Ø 125 mm	Ø 22,2 mm	3 mm	10



FESTA

DISK ZA
BRUŠENJE DRVETA
GRUBO



Br.	Specifikacija			
21801	Ø 125 mm	Ø 22,2 mm	3 mm	10



FESTA

DISK
ZA BRUŠENJE
DRVETA



Br.	Specifikacija			
21803	Ø 125 mm	Ø 22,2 mm		1



NEW

FESTA

DISK ZA
BRUŠENJE DRVETA



Br.	Specifikacija			
21805	Ø 125 mm	Ø 22,2 mm		1



FESTA

DISC DRVO
SA RUPAMA



Br.	Specifikacija			
21800	Ø 125 mm	Ø 22,2 mm		1



· Za brušenje drva

FESTA

TURPIJICE ROTACIONE

M14



Br.	Specifikacija			
21807	Ø 30 mm / 60 mm			1

40 mm



FESTA

TURPIJICE ROTACIONE

M14



Br.	Specifikacija			
21808	Ø 30 mm / 105 mm			10

65 mm



REZNA
PLOČA
ZA DRVETA



Br.	Specifikacija			
21804	Ø 125 mm	Ø 22,2 mm	14T	1



NEW

REZNA PLOČA ZA DRVETA



Br.	Specifikacija		
21809	Ø 125 mm x 4T	Ø 22,2 mm	1

NEW

FESTA LAMELNI DISK



Br.	Specifikacija		asperity	
21760	Ø 125 mm	Ø 22,2 mm	P40	10
21761	Ø 125 mm	Ø 22,2 mm	P60	10
21762	Ø 125 mm	Ø 22,2 mm	P80	10
21763	Ø 125 mm	Ø 22,2 mm	P100	10
21764	Ø 125 mm	Ø 22,2 mm	P120	10

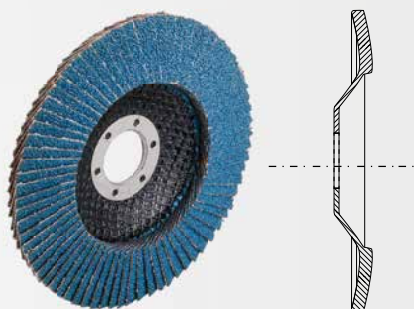

FESTA LAMELNI-DISK

· Za brušenje nerđajućeg čelika



Br.	Specifikacija		asperity	
22140	Ø 115 mm	Ø 22,2 mm	P40	5
22141	Ø 115 mm	Ø 22,2 mm	P60	5
22142	Ø 115 mm	Ø 22,2 mm	P80	5
22143	Ø 115 mm	Ø 22,2 mm	P100	5
22145	Ø 125 mm	Ø 22,2 mm	P40	5
22146	Ø 125 mm	Ø 22,2 mm	P60	5
22147	Ø 125 mm	Ø 22,2 mm	P80	5
22148	Ø 125 mm	Ø 22,2 mm	P100	5
22150	Ø 150 mm	Ø 22,2 mm	P40	5
22151	Ø 150 mm	Ø 22,2 mm	P60	5
22155	Ø 150 mm	Ø 22,2 mm	P80	5
22156	Ø 150 mm	Ø 22,2 mm	P100	5

NEW

FESTA LAMELNI-DISK DIJAM.



- Keramičke pločice
- Mermer
- Granit



- Upotreba bez vodenog hlađenja

Br.	Specifikacija			
24647	Ø 115 mm	Ø 22,2 mm	● P60	1
24648	Ø 115 mm	Ø 22,2 mm	● P120	1
24649	Ø 115 mm	Ø 22,2 mm	● P200	1



LAMELNI-DISK



Br.	Specifikacija		asperity	
21780	Ø 115 mm	Ø 22,2 mm	P40	10
21781	Ø 115 mm	Ø 22,2 mm	P60	10
21782	Ø 115 mm	Ø 22,2 mm	P80	10
21783	Ø 115 mm	Ø 22,2 mm	P100	10
21784	Ø 115 mm	Ø 22,2 mm	P120	10
21786	Ø 125 mm	Ø 22,2 mm	P40	10
21787	Ø 125 mm	Ø 22,2 mm	P60	10
21788	Ø 125 mm	Ø 22,2 mm	P80	10
21789	Ø 125 mm	Ø 22,2 mm	P100	10
21790	Ø 125 mm	Ø 22,2 mm	P120	10
21792	Ø 150 mm	Ø 22,2 mm	P40	10
21793	Ø 150 mm	Ø 22,2 mm	P60	10
21794	Ø 150 mm	Ø 22,2 mm	P80	10
21795	Ø 150 mm	Ø 22,2 mm	P100	10
21796	Ø 150 mm	Ø 22,2 mm	P120	10

ČETKA NAJLON ZA POLIRANJE



Br.	Specifikacija		
21798	Ø 125 mm	Ø 22,2 mm	1



FESTA



20mm

FESTA
ČETKA ČEL. POLULONČASTA

· Mesingani premaz

M14



Br.	Specifikacija	Žice	
21900	Ø 100 mm M14	s 0,3	60
21902	Ø 125 mm M14	s 0,3	42



10mm

FESTA
ČETKA ČEL. POLULONČASTA

· Mesingani premaz

M14



Br.	Specifikacija	Žice	
22001	Ø 100 mm M14	s 0,3	60
21901	Ø 125 mm M14	s 0,3	42

FESTA
ČETKA ČEL. POLULONČASTA

· Mesing

M14



Br.	Specifikacija	Žice	
21920	Ø 100 mm M14	s 0,3	60

FESTA
ČETKA ČEL. LONČASTA

· Mesingani premaz

M14



Br.	Specifikacija	Žice	
21903	Ø 65 mm M14	s 0,3	60
22002	Ø 75 mm M14	s 0,3	80
21904	Ø 85 mm M14	s 0,3	60
22003	Ø 100 mm M14	s 0,3	36
21905	Ø 125 mm M14	s 0,3	24
21906	Ø 150 mm M14	s 0,3	12

FESTA
ČETKA ČEL. LONČASTA

· Mesing

M14



Br.	Specifikacija	Žice	
21925	Ø 75 mm M14	0,3 mm	80
21926	Ø 100 mm M14	0,3 mm	36

FESTA
ČETKA ČEL. PLJOSNATA

· Mesingani premaz

· Redukcijski prstenovi



Br.	Specifikacija	Žice	
22007	Ø 100 mm Ø 20 mm	s 0,3	60
22008	Ø 125 mm Ø 20 mm	s 0,3	42
22009	Ø 150 mm Ø 32,2 mm	s 0,3	32
22010	Ø 175 mm Ø 32,2 mm	s 0,3	20
22011	Ø 200 mm Ø 32,2 mm	s 0,3	20

FESTA
ČETKA ČEL. ZA BRUSILICU

· Otvrdnuto

INOX M14



Br.	Specifikacija	Žice	
22037	Ø 65 mm M14	s 0,5	60
22038	Ø 80 mm M14	s 0,5	24

FESTA
ČETKA ČEL. ZA BRUSILICU

· Otvrdnuto

M14



Br.	Specifikacija	Žice	
22004	Ø 65 mm M14	s 0,3	60
22005	Ø 75 mm M14	s 0,3	24
22006	Ø 100 mm M14	s 0,3	24
21907	Ø 125 mm M14	s 0,3	24
21908	Ø 150 mm M14	s 0,3	12

FESTA
ČETKA ČEL. PLJOSNATA

· Otvrdnuto

M14



Br.	Specifikacija	Žice	počet copū	
21911	Ø 100 mm M14	s 0,5	30	60
21912	Ø 115 mm M14	s 0,5	32	42
21913	Ø 125 mm M14	s 0,5	36	42
21914	Ø 150 mm M14	s 0,5	40	32

FESTA
ČETKA ČEL. PLJOSNATA

· Otvrdnuto

M14

Br.	Specifikacija	Žice	
22012	Ø 100 mm M14	s 0,5	60
22013	Ø 115 mm M14	s 0,5	42
22014	Ø 125 mm M14	s 0,5	42
22015	Ø 150 mm M14	s 0,5	32
22016	Ø 178 mm M14	s 0,5	20

FESTA
ČETKA ČEL. PLJOSNATA

· Otvrdnuto

INOX M14

Br.	Specifikacija	Žice	
22039	Ø 100 mm M14	s 0,5	60
22040	Ø 125 mm M14	s 0,5	42

FESTA
ČETKA ČEL. POLULONČASTA

· Otvrdnuto

M14

Br.	Specifikacija	Žice	
22017	Ø 100 mm M14	s 0,5	60
21909	Ø 115 mm M14	s 0,5	42
21910	Ø 125 mm M14	s 0,5	42



Ø 6 mm

FESTA
ČETKA ČEL. PLJOSNATA UPREDENA

· Otvrdnuto



Br.	Specifikacija	Žice	
22023	Ø 75 mm	s 0,5	10



Ø 6 mm

FESTA
ČETKA ČEL. LONČASTA UPREDENA

· Otvrdnuto



Br.	Specifikacija	Žice	
22024	Ø 75 mm	s 0,5	12



Ø 6 mm

FESTA
ČETKA ČEL. POLULONČASTA UPREDENA

· Otvrdnuto



Br.	Specifikacija	Žice	
22025	Ø 75 mm	s 0,5	12

NEW

FESTA
ČETKA ČEL. PLJOSNATA UPREDENA

Br.	Specifikacija	Žice	
21950	Ø 200 mm 25,4 mm		1



Ø 6 mm

FESTA
ČETKA ČEL. LONČASTA

· Mesingani premaz



Br.	Specifikacija	Žice	
22030	Ø 65 mm	s 0,3	12
22031	Ø 75 mm	s 0,3	12



Ø 6 mm

FESTA
ČETKA ČEL. PLJOSNATA

· Mesingani premaz



Br.	Specifikacija	Žice	
22026	Ø 50 mm	s 0,3	15
22027	Ø 63 mm	s 0,3	15
22028	Ø 75 mm	s 0,3	10
22029	Ø 100 mm	s 0,3	15



Ø 6 mm

FESTA
ČETKA ČEL.

Br.	Specifikacija	Žice	
22058	Ø 12 mm	s 0,3	25
22059	Ø 25 mm	s 0,3	25



Ø 6 mm

FESTA
ČETKA ČEL.

· Mesingani premaz



Br.	Specifikacija	Žice	
22018	Ø 12 mm	s 0,3	15
22019	Ø 17 mm	s 0,3	15
22020	Ø 25 mm	s 0,3	25



Ø 6 mm

FESTA
ČETKA ČEL. UPREDENA

· Otvrdnuto



Br.	Specifikacija	Žice	
22021	Ø 19 mm	s 0,5	30
22022	Ø 22 mm	s 0,5	25



FESTA

ČETKA LONČASTA ZA POLIRANJE

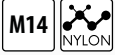

Br.	Specifikacija	Žice	
21940	Ø 75 mm M14	1,2 mm	1
21941	Ø 100 mm M14	1,2 mm	1



FESTA

ČETKA OKRUGLA ZA POLIRANJE



Br.	Specifikacija	Žice	
21930	Ø 125 mm M14	1,2 mm	10
21931	Ø 150 mm M14	1,2 mm	15

Ø 6 mm



FESTA

ČETKA OKRUGLA ZA POLIRANJE



Br.	Specifikacija	Žice	
22032	Ø 100 mm	1,2 mm	12

Ø 6 mm



FESTA

ČETKA OKRUGLA ZA POLIRANJE



Br.	Specifikacija	Žice	
21935	Ø 50 mm	1,2 mm	15
21936	Ø 75 mm	1,2 mm	10
21937	Ø 100 mm	1,2 mm	15



Ø 6 mm

ČETKA NAJLON



Br.	Specifikacija	
22088	Ø 65 mm	9
22090	Ø 100 mm	5



ČETKA NAJLON ZA POLIRANJE



Br.	Specifikacija	
22083	Ø 115 mm Ø 22,2 mm	10
22084	Ø 125 mm Ø 22,2 mm	10
22085	Ø 150 mm Ø 22,2 mm	10



ČETKA NAJLON



Br.	Specifikacija	
22095	Ø 178 mm	1

NEW

FESTA

DIJAMANTSKI DISK ZA BRUŠENJE NA ČIČAK

- Keramičke pločice
- staklo
- Mermer
- Granit



· gumeni disk 22043

Br.	Specifikacija	asperity	
24665	Ø 100 mm	● P60	10
24666	Ø 100 mm	● P120	10
24667	Ø 100 mm	● P200	10

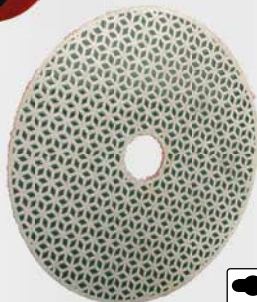

FESTA

DIJAMANTSKI DISK ZA POLIRANJE Ø 100 MM, NA ČIČAK

- Keramičke pločice
- staklo
- Mermer
- Granit



· gumeni disk 22043

Br.	asperity	
22701	50	1
22702	100	1
22703	200	1
22704	400	1
22705	800	1
22706	1500	1
22707	3000	1



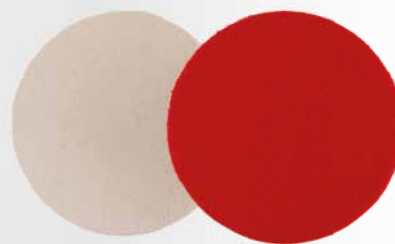

POLIR JASTUČE



Br.	Specifikacija	Specifikacija	
22065	Ø 125 mm	Na čičak	20
22066	Ø 150 mm	Na čičak	20

DISK ZA POLIRANJE



Br.	Specifikacija	
22070	Ø 115 mm	20
22071	Ø 125 mm Na čičak	20
22072	Ø 150 mm	20

FESTA

GUMENI DISK ZA BUŠILICU, NA ČIČAK

- M14 | Ø 8 mm
- EVA 10 mm

Br.	Specifikacija	
22062	Ø 115 mm	25
22063	Ø 125 mm	25
22064	Ø 150 mm	10



FESTA

GUMENI DISK ZA BRUSILICU ZA FIBER DISK



Br.	Specifikacija	
22073	Ø 125 mm, M14	1
22074	Ø 150 mm, M14	1



FESTA

GUMENI DISK ZA BRUSILICU

- Za ugaonu brusilicu
- za 24665-24667, 22701-22707

Br.	Specifikacija	
22043	Ø 100 mm Na čičak	1



GUMENI DISK ZA BRUSILICU

- Za ugaonu brusilicu

Br.	Specifikacija	
22044	Ø 125 mm M14 Na čičak	15
22060	Ø 150 mm M14 Na čičak	6



ADAPTER

Br.	Specifikacija	
22087		1



GUMENI DISK ZA BUŠILICU

Br.	Specifikacija	
22061	Ø 125 mm Na čičak	6

GUMENI DISK ZA BUŠILICU

Br.	Specifikacija	
22041	Ø 125 mm Učvršćivanje vijkom	11
22042	Ø 125 mm Na čičak	11



Br.	Specifikacija	
22091	Ø 50 mm P240	1
22092	Ø 75 mm P240	1
22093	Ø 100 mm P240	1

ČETKA NAJLON, BRUSNI

FESTA

FIBER DISK - Ø 125 MM



Br.	asperity	
22160	P40	1
22161	P60	1
22162	P80	1
22163	P100	1
22164	P120	1



FESTA

FIBER DISK - Ø 150 MM



Br.	asperity	
22167	P80	1



FESTA

BRUSNI PAPIR Ø 125 MM, NA ČIČAK

3x

Br.	asperity	
22045	P40	1
22046	P60	1
22047	P80	1
22048	P100	1
22049	P120	1
22050	P150	1
22051	P180	1
22052	P220	1

**FESTA**

BRUSNI PAPIR Ø 150 MM, NA ČIČAK

3x

Br.	asperity	
22053	P40	1
22054	P60	1
22055	P80	1
22056	P100	1
22057	P120	1

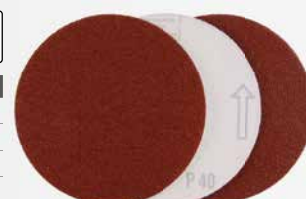
**FESTA**

BRUSNA TRAKA 75 X 533 MM

FESTA

BRUSNI PAPIR NA 94 X 94 X 94 MM



5x

Br.	asperity	
21831	P60	1
21832	P80	1
21834	P120	1



BRUSNI PAPIR NA ČIČAK 125 MM

3x

Br.	asperity	
22096	P40	20
22097	P60	20
22098	P80	20
22099	P120	20



3x

Br.	asperity	
21810	P40	20
21811	P60	20
21812	P80	20
21813	P100	20
21814	P120	20



BRUSNI PAPIR 93 X 230 MM NA ČIČAK

5x

Br.	asperity	broj rupa	
21740	P40	8	20
21741	P60	8	20
21742	P80	8	20
21743	P100	8	20
21744	P120	8	20



BRUSNI PAPIR 115 X 280 MM NA ČIČAK

5x

Br.	asperity	broj rupa	
21750	P40	10	20
21751	P60	10	20
21752	P80	10	20
21753	P100	10	20
21754	P120	10	20

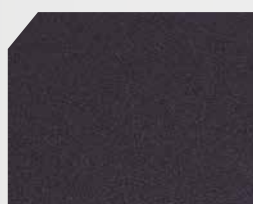

BRUSNI PAPIR NA PLATNJU 30 X 280 MM

10x

Br.	asperity	
21732	P40	1
21734	P60	1
21735	P80	1
21736	P100	1
21737	P120	1

10x

Br.	asperity	
21701	P60	1
21702	P80	1
21703	P100	1
21704	P120	1
21705	P150	1
21706	P180	1
21709	P240	1

10x

Br.	asperity	
21715	P40	1
21716	P60	1
21717	P80	1
21718	P100	1
21719	P120	1
21720	P150	1
21721	P180	1
21724	P240	1

BRUSNI PAPIR VODOODPORAN

BRUSNI PAPIR 230 X 280 MM

NEW



FESTA

DRŽAČ BRUSNOG PAPIRA

· Ø 150 mm



Br.	Specifikacija	
22119		1

FESTA

DRŽAČ BRUSNOG PAPIRA

· Quick grip



Br.	Specifikacija	
22067	170 x 70 mm	10

DRŽAČ BRUSNOG PAPIRA



Br.	Specifikacija	
22075	210 x 105 mm	100
22076	160 x 85 mm	100

DRŽAČ BRUSNOG PAPIRA



Br.	Specifikacija	
22077	125 x 68 mm	10

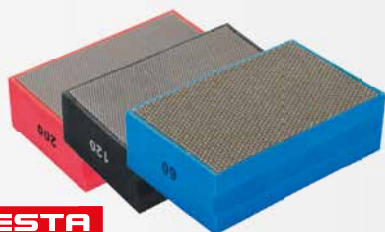

FESTA

DIJAMANTSKI ABRAZIVNI SUNDJER

· 90 x 55 x 25 mm
· Keramičke pločice
· staklo
· Mermer
· Granit



Br.	asperity	
22115	P60	10
22116	P120	10
22117	P200	10

BRUSNE LAMELNE LEPEZE

Br.	asperity	Specifikacija	
21850	P40		1
21851	P60		1
21852	P80	20 x 20, Ø 6 mm	1
21853	P100		1
21854	P120		1
21855	P40		1
21856	P60		1
21857	P80	30x30, Ø 6mm	1
21858	P100		1
21859	P120		1
21860	P40		1
21861	P60		1
21862	P80	60x30, Ø 6mm	1
21863	P100		1
21864	P120		1



FESTA

BRUSNI SUNDJER 100 X 70 X 28 MM - ZAKOŠENY

Br.	asperity	
22106	P 60	10
22107	P 80	10
22108	P 100	10
22109	P 120	10



FESTA

BRUSNI SUNDJER 100 X 70 X 25 MM

Br.	asperity	
22100	P60	20
22101	P80	20
22102	P100	20
22103	P120	20
22104	P180	20
22105	P220	20



FESTA

BRUSNI SUNDJER 120 X 95 X 10 MM

Br.	asperity	
22110	P80	20
22111	P120	20
22112	P180	20
22113	P220	20



FESTA

Br.	Specifikacija	tooth	
Ø 115 mm			
22300	Ø 115 x 22 mm	40	1
Ø 125 mm			
22301	Ø 125 x 22 mm	40	1
Ø 140 mm			
22302	Ø 140 x 20 mm	24	1
22303	Ø 140 x 20 mm	30	1
Ø 150 mm			
22305	Ø 150 x 20 mm	24	1
Ø 160 mm			
22307	Ø 160 x 20 mm	18	1
22309	Ø 160 x 20 mm	24	1
22310	Ø 160 x 20 mm	30	1
22311	Ø 160 x 20 mm	36	1
22312	Ø 160 x 20 mm	48	1
22313	Ø 160 x 20 mm	60	1
Ø 165 mm			
22314	Ø 165 x 20 mm	24	1
Ø 180 mm			
22315	Ø 180 x 30 mm	24	1
22317	Ø 180 x 30 mm	50	1
22318	Ø 180 x 20 mm	50	1
Ø 185 mm			
22316	Ø 185 x 20 mm	24	1
Ø 190 mm			
22319	Ø 190 x 20 mm	40	1
22320	Ø 190 x 30 mm	40	1
Ø 200 mm			
22322	Ø 200 x 30 mm	24	1
22324	Ø 200 x 30 mm	40	1
22326	Ø 200 x 30 mm	60	1
Ø 205 mm			
22328	Ø 205 x 30 mm	40	1
22329	Ø 205 x 30 mm	60	1
Ø 210 mm			
22332	Ø 210 x 30 mm	40	1
22333	Ø 210 x 30 mm	60	1
Ø 250 mm			
22335	Ø 250 x 30 mm	40	1
22337	Ø 250 x 30 mm	60	1
Ø 300 mm			
22340	Ø 300 x 30 mm	40	1
22343	Ø 300 x 30 mm	60	1
22345	Ø 300 x 30 mm	96	1
Ø 350 mm			
22350	Ø 350 x 30 mm	40	1
22351	Ø 350 x 30 mm	54	1
Ø 400 mm			
22355	Ø 400 x 30 mm	40	1
22357	Ø 400 x 30 mm	60	1
Ø 500 mm			
22365	Ø 500 x 30 mm	60	1
Ø 600 mm			
22370	Ø 600 x 30 mm	60	1

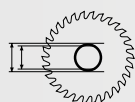
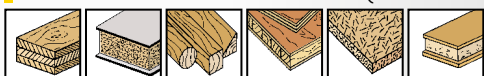
**FESTA****CIRKULARNE TESTERA (ZA DRVO)****REDUKTORSKI PRSTEN**

Br.	Specifikacija	
22399	Ø 20 16 mm	1
22398	Ø 30 25 mm	1

FESTA

OSCILIRAJUĆI SET PRIBORA ZA VIŠE ALATA

za 28045

FESTA
POWER X TOOLS



4x

3x BI-METAL



1x SK5

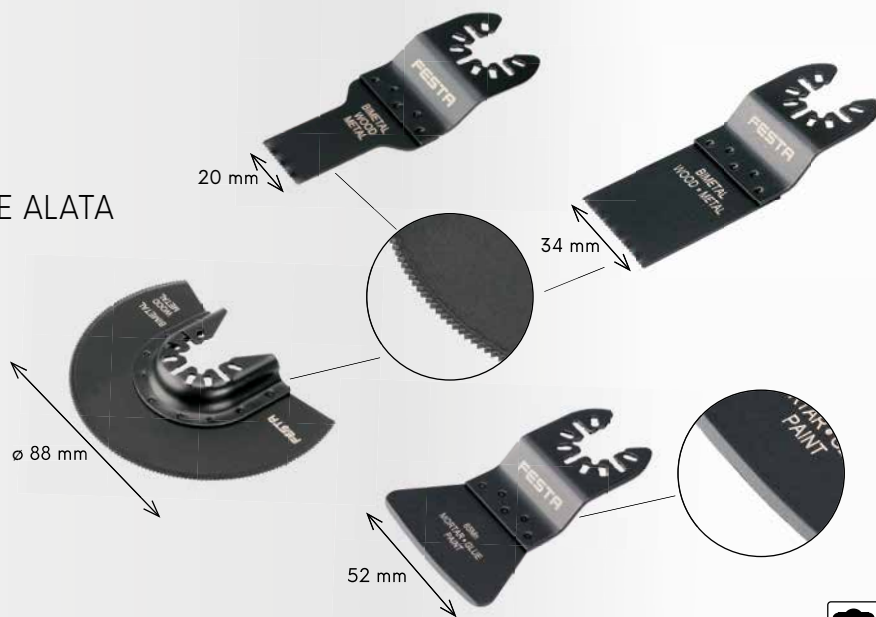

Br. Specifikacija

24322

10

FESTA

OSCILIRAJUĆI SET PRIBORA ZA VIŠE ALATA

za 28045

FESTA
POWER X TOOLS



4x

3x CARBIDE



1x

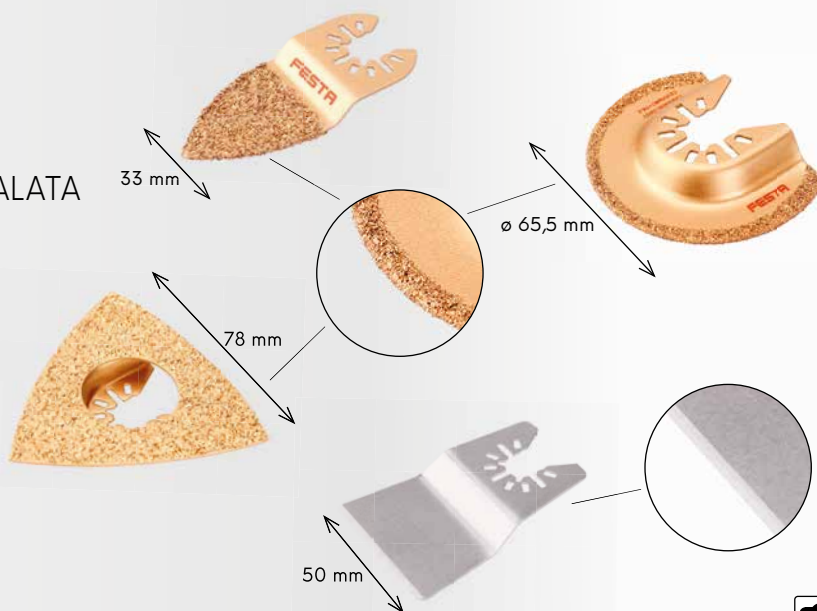

Br. Specifikacija

24321

10

OSCILIRAJUĆI SET PRIBORA ZA VIŠE ALATA

za 28045

FESTA
POWER X TOOLS



HCS 3x

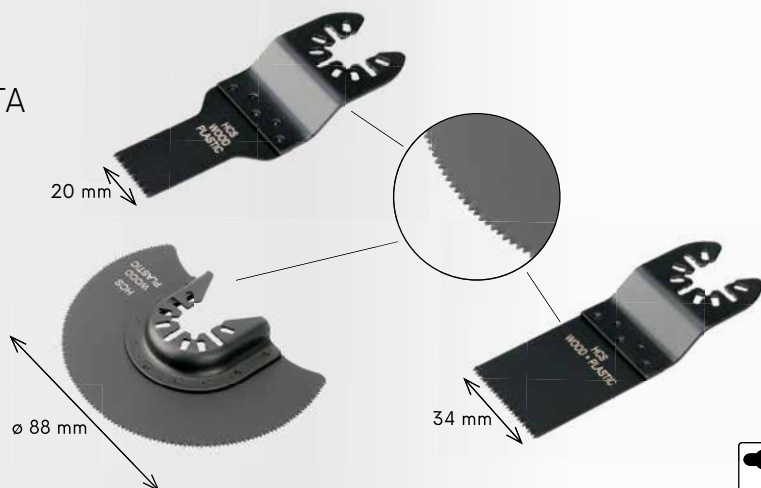

Br. Specifikacija

24320

10

PROFI TESTERE
PROIZVEDENE U NEMAČKOJ TEHNOLOGIJOM PALJENJA LASEROM



UBODNA TESTERA HSS - PRIČVRŠĆIVANJE BOSCH (AEG, BOSCH, FESTO, MAKITA, METABO)

	24060	50mm/1mm	0,7 mm/ 36TPI	31007	5 kom	10	
	24061	50mm/1mm	1,2 mm/ 21TPI	31012	5 kom	10	
	24062	50mm/1mm	2,0 mm/ 13TPI	31020	5 kom	10	
	24063	75mm/1mm	3,0 mm/ 8TPI	31030	5 kom	10	
	24064	100mm/1mm	1,2 mm/ 21TPI	31112	5 kom	10	
	24065	100mm/1,3mm	2,0 mm/ 13TPI	31112	5 kom	10	
	24066	75mm/1,45mm	2,0 mm/ 13TPI	31220	5 kom	10	
	24067	120mm/1,3mm	1,8 - 2,4 mm/ 10 - 14 TPI	31220	5 kom	10	
	24068	75mm/1,45mm	2,5 mm/ 10 TPI	32225	5 kom	10	
	24069	75mm/1,45mm	4 mm/ 6 TPI	32240	5 kom	10	
	24070	75mm/1,3mm	4 mm/ 6 TPI	32340	5 kom	10	
	24071	75mm/1,3mm	4 mm/ 6 TPI	32440	5 kom	10	
	24072	75mm/1,45mm	2,5 mm/ 10 TPI	32625	5 kom	10	
	24073	85mm/1,45mm	3 mm/ 8 TPI	32730	5 kom	10	
	24074	85mm/1,45mm	4 mm/ 6 TPI	32730	5 kom	10	
	32825	75mm/1,45mm	2,5 1,2 mm/10 21 TPI	32825	5 kom	10	
	24076	75mm/1,7mm	4 mm 6 TPI	32940	5 kom	10	
	24077	120mm/1,3mm	4 mm 6 TPI	32040	5 kom	10	
	24078	105mm/1,45mm	4 mm 6 TPI	34040	5 kom	10	
	24055	55mm	karbid		5 kom	1	

UBODNA TESTERA HSS - PRIČVRŠČIVANJE BLACK & DECKER (BLACK & DECKER, SKIL)

	24080	50mm 1,0 mm	1,2 21 TPI	11012	5 kom	10	
	24081	75mm 1,0 mm	3,0 8 TPI	11030	5 kom	10	
	24082	75mm 1,45 mm	2,5 10 TPI	12225	5 kom	10	
	24083	75mm 1,45 mm	4 6 TPI	12240	5 kom	10	
	24084	75mm 1,3 mm	4 6 TPI	12340	5 kom	10	
	24085	50mm 1,0 mm	2,0 13 TPI	12420	5 kom	10	
	24086	75mm 1,3 mm	4,0 6 TP	12440	5 kom	10	
	24087	75mm 1,45 mm	2,5 10 TPI	12625	5 kom	10	

	Mekani čelik (sa malom količinom ugljika)		Čelični lim		Nerđajući čelik		Laminirano drvo
	Metali bez željeza		Tvrdo i mekano drvo		Iverica		Plastika
	Šperploča		Šperploča		Drvo sa čavlima		
	Sendvič materijal		Crep		Aluminijum		

STALAK ZA PROFI UBODNE TESTERE

- Sadrži 24098 - 24060 · 5 kom
- 24080 · 5 kom
- 24061 · 5 kom
- 24062 · 5 kom
- 24081 · 5 kom
- 24063 · 5 kom
- 24066 · 5 kom
- 24067 · 5 kom
- 24082 · 5 kom
- 24068 · 5 kom
- 24083 · 5 kom
- 24069 · 5 kom
- 24084 · 5 kom
- 24070 · 5 kom
- 24086 · 5 kom
- 24071 · 5 kom
- 24087 · 5 kom
- 24072 · 5 kom
- 24073 · 5 kom
- 24074 · 5 kom
- 24075 · 5 kom
- 24076 · 5 kom



SET UBODNIH TESTERA



5x

Br.	Specifikacija	50
24045	sada	50

Br.	Specifikacija	1
24099	64 x 50 cm - Prazan	1
24098	64 x 50 cm - Sa ubodnim testerama	1

FESTA

UBODNA TESTERA

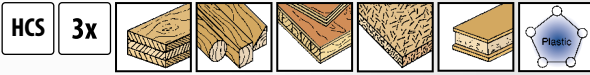

Br. 24301 Specifikacija 150 x 19 x 1,3 mm TPI 6



FESTA

UBODNA TESTERA

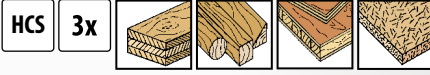

Br. 24302 Specifikacija 225 x 19 x 1,3 mm TPI 3



FESTA

UBODNA TESTERA

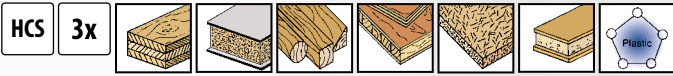

Br. 24303 Specifikacija 200 x 19 x 1,3 mm TPI 6 - 10



FESTA

UBODNA TESTERA

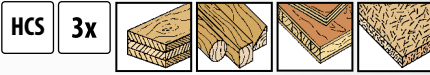

Br. 24304 Specifikacija 240 x 19 x 1,5 mm TPI 5



FESTA

UBODNA TESTERA

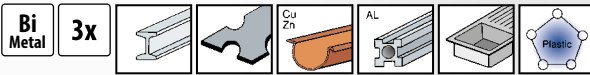

Br. 24305 Specifikacija 150 x 19 x 1 mm TPI 24

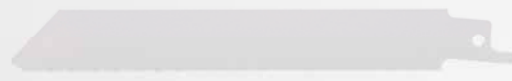

FESTA

UBODNA TESTERA

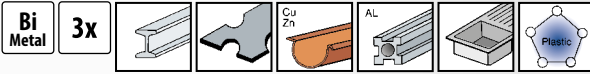

Br. 24306 Specifikacija 150 x 19 x 1 mm TPI 9



FESTA

UBODNA TESTERA



Br. 24308 Specifikacija 225 x 19 x 1 mm TPI 10 - 14



FESTA

UBODNA TESTERA



Br. 24310 Specifikacija 150 x 22 x 1,6 mm TPI 9



FESTA

UBODNA TESTERA



Br.	Specifikacija	
24313	225 x 22 x 1,6 mm TPI 6	1

FESTA

METALNA TESTERA HSS

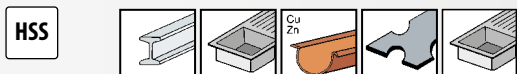

Br.	Specifikacija	
24050	203 x 19 x 1 mm TPI 10 - 14	25

FESTA

UBODNA TESTERA

· Karbidna tehnologija

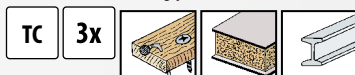

Br.	Specifikacija	
24312	225 x 19 x 1,3 mm TPI 6 - 9	1

FESTA

UBODNA TESTERA



Br.	Specifikacija	
24315	305 x 50 x 1,5 mm	1
24316	455 x 50 x 1,5 mm	25

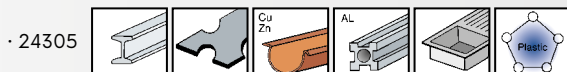
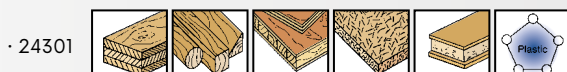

FESTA

SET UBODNIH TESTERA



Br.	Specifikacija	
24314		1

FESTA

DRŠKA ZA LISTOVE TESTERE

· ručka + 2k list testere
· za listove klipne testere



Br.	Specifikacija	
24325		1





FESTA
INDUSTRY



LIST TESTERE

· Termički ojačani zubi



Br.	Specifikacija	
24185	533 mm	1
24186	610 mm	1
24187	760 mm	1
24188	800 mm	1
24189	914 mm	1

FESTA

LIST TESTERE

· Termički ojačani zubi



Br.	Specifikacija	
24169	350 mm	10
24167	450 mm	10
24166	533 mm	10
24163	610 mm	10
24164	760 mm	10
24168	800 mm	10
24165	914 mm	10



LIST TESTERE



Br.	Specifikacija	
24195	šipka 3 mm 300 mm	1
24196	šipka 4 mm 300 mm Kosi zubi	1
24197	šipka 5 mm 300 mm Termički ojačani zubi	1
24192	List za testere 24128 - 450 mm	1



LIST TESTERE

Br.	Specifikacija	
24160	šipka 3 mm 300 mm	20
24161	šipka 4 mm 300 mm	20
24162	šipka 5 mm 300 mm	50

LIST BONSEKA

10x



Br.	Specifikacija	
24108	6 mm 150 mm	1

REZNA STRUNA



Br.	Specifikacija	
24120	300 mm	50



FESTA

LIST BONSEKA BI-METAL

· 8 % COBALT



Br.	Specifikacija	
24180	300 mm	125

FESTA

LIST BONSEKA



Br.	Specifikacija	
24109	12,5 mm 300 mm Za metal	144
24118	25 mm 300 mm Za metal obostrana	72
24119	25 mm 300 mm Za metal, drvo	72





96

MERNE TRAKE



101

METAR DRVENI



104

RAVNALA I UGLOMERI



106

MERNI ALATI



112

LASERSKI MERAČI



116

OLOVKE I MARKERI



120

SPREJEVI



122

SKALPERI I SEČIVO



137

REZAČ ZA CEVI I MAKAZE ZA PVC CEVI



140

ODVIJAČI



146

STAHLBERG BITOVI,
KOMPLET BITOVI

154

SETOVI GEDORE



159

NASTAVCI GEDORA



164

KLJUČEVI



169

KLEŠTA



179

MAKAZE



182

KLEŠTA ZA POP NITNE



188

TURPIJE



190

RUCNE TESTERE



195

ČEKIČI



203

STEGE

ALATI

94 - 205



KOMELON®

· MERILA VRHUNSKOG KVALITETA I TOČNOSTI

- II. klasa tačnosti prema EEC 755345
- Najlonski površinski sloj DURA NY Coat™

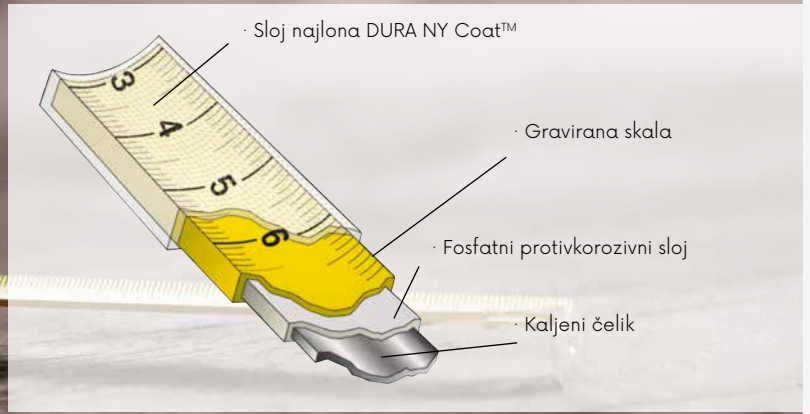

· Sloj najlona DURA NY Coat™

KOMELON® METAR



Br.	Specifikacija	
10002	2 m · 16 mm	10
10003	3 m · 16 mm	10
10005	5 m · 19 mm	10
10008	8 m · 25 mm	10



· Sloj najlona DURA NY Coat™

KOMELON® METAR



Br.	Specifikacija	
10025	5 m · 25 mm	10



· Sloj najlona DURA NY Coat™

KOMELON® METAR

- Automatska kočnica
- Gumirani



Br.	Specifikacija	
10033	3 m · 16 mm	6
10035	5 m · 19 mm	6



KOMELON® METAR



Br.	Specifikacija	
10043	3 m · 16 mm	30
10045	5 m · 19 mm	30
10048	8 m · 25 mm	12



KOMELON® PANTLJIKA ČELIČNA



Br.	Specifikacija	
10110	10 m · 10 mm	6
10120	20 m · 10 mm	6
10130	30 m · 10 mm	6



KOMELON® PANTLJIKA PLATNENA



Br.	Specifikacija	
10330	10 m · 13 mm	6
10332	20 m · 13 mm	6
10334	30 m · 13 mm	6
10336	50 m · 13 mm	6



KOMELON®
PANTLIJKA
PLATNENA



Br.	Specifikacija	
10430	30 m · 13 mm	1
10450	50 m · 13 mm	1
10490	100 m · 13 mm	1



· Ilustraciona fotografija

**STALAK
ZA METRE**

Br.	Specifikacija	
10998		1

KOMELON®
STALAK ZA METRE

· Ispunjen sa stavkama 10996

10003 ·	5 kom
10005 ·	4 kom
10008 ·	1 kom
10033 ·	2 kom
10035 ·	3 kom
10045 ·	2 kom
10025 ·	3 kom
10110 ·	1 kom
10120 ·	1 kom
10130 ·	1 kom
10430 ·	1 kom
10330 ·	1 kom
10332 ·	1 kom
10334 ·	1 kom
10336 ·	1 kom



· Ilustraciona fotografija

Br.	Specifikacija	
10999	Stalak za metre	1
10996	Stalak za metre ispunjen	1



· Information about the tape



- A** 5m · length of tape
- B** II · accuracy class
- C** CE · declaration of conformity - CE
- D** M17 · year of manufacture
- E** 0071 · the number of the accredited certification office issuing the certificate
- F** 9 · producer
- G** 12 · special tape adjustment
- H** 20 °C · the temperature at which the test was performed

FESTA



FESTA

METAR

- Skala sa velikim brojevima
- Gumirani
- Sloj najlona



Br.	Specifikacija	
11353	3 m · 19 mm	12
11355	5 m · 19 mm	12
11356	5 m · 25 mm	12
11358	8 m · 25 mm	6
11360	10 m · 25 mm	6



FESTA

METAR

- Sloj najlona
- Kućište ABS
- Hromirana metalna spona
- Automatska kočnica
- Gumirani PTE
- Petlje



Br.	Specifikacija	
11343	3 m · 16 mm	6
11345	5 m · 19 mm	6
11347	7,5 m · 25 mm	6



FESTA

METAR

- 3 x kočnica
- Magnetni završetak
- Kočenje
- Gumirani



Br.	Specifikacija	
11323	3 m · 19 mm	10
11325	5 m · 25 mm	10
11327	7,5 m · 25 mm	6



FESTA

METAR

- Magnetni završetak
- Gumirani
- Fluorescentna traka
- Skala sa velikim brojevima



Br.	Specifikacija	
11102	2 m · 16 mm	10
11103	3 m · 16 mm	10
11105	5 m · 19 mm	12
11106	5 m · 25 mm	12
11107	7,5 m · 25 mm	10
11110	10 m · 25 mm	6



FESTA

METAR

- Skala sa velikim brojevima



Br.	Specifikacija	
11226	2 m · 16 mm	10
11239	3 m · 19 mm	10
11259	5 m · 19 mm	12
11260	7,5 m · 25 mm	6



FESTA

METAR

- Automatska kočnica
- Gumirani



Br.	Specifikacija	
11333	3 m · 16 mm	12
11335	5 m · 19 mm	12
11337	7,5 m · 25 mm	6
11338	10 m · 25 mm	6



FESTA

METAR

- Kompaktna veličina
- Sloj najlona



Br.	Specifikacija	
11220	3 m · 16 mm	12
11221	5 m · 19 mm	12

**Johnney®****METAR**

· Matna površina trake

II. class

Br.	Specifikacija	
11002	2 m · 13 mm	12
11003	3 m · 13 mm	12
11005	5 m · 13 mm	12
11006	5 m · 19 mm	12
11007	7,5 m · 19 mm	12
11008	10 m · 25 mm	12

**METAR**· Kočenje
· Gumirani

Br.	Specifikacija	
11082	2 m · 16 mm	12
11083	3 m · 16 mm	12
11085	5 m · 19 mm	12

**METAR**· cm / inch
· Gumirani

Br.	Specifikacija	
11416	5 m · 19 mm	10

**METAR**

· Kočenje



Br.	Specifikacija	
11200	2 m · 13 mm	24
11201	2 m · 16 mm	24
11202	2 m · 19 mm	24
11204	3 m · 13 mm	24
11205	3 m · 16 mm	24
11206	3 m · 19 mm	24
11207	5 m · 19 mm	12
11208	5 m · 25 mm	12
11209	7,5 m · 25 mm	12
11210	10 m · 25 mm	12

**METAR SA IMENOM,
3M · 16 MM****CE II. class**

Č.p.	jméno na metru
13500	JIŘÍ
13501	PETR
13502	JOSEF
13503	TOMÁŠ
13504	JAN
13505	MARTIN
13506	JAROSLAV
13507	FRANTIŠEK
13508	PAVEL

Č.p.	jméno na metru
13509	MIROSLAV
13510	BIG BOSS
13511	ZDENĚK
13512	MICHAL
13513	MILAN
13514	KAREL
13515	VLADIMÍR
13516	DĚDEČEK
13517	MŮJ METR



Č.p.	jméno na metru
13518	VÁCLAV
13519	JAKUB
13520	LUKÁŠ
13521	2X MĚŘ
13522	LADISLAV
13523	DAVID
13524	ROMAN
13525	ŠIKULA
13526	RADEK

10

**FESTA****PANTLJIKA
ČELIČNA**

· Oko

CE II. class

Br.	Specifikacija	
12010	10 m · 10 mm	1
12020	20 m · 10 mm	1
12030	30 m · 10 mm	1
12050	50 m · 10 mm	6

**FESTA****PANTLJIKA OD
FIBER-STAKLA**

· Oko

CE II. class

Br.	Specifikacija	
12110	10 m · 13 mm	6
12120	20 m · 13 mm	1
12130	30 m · 13 mm	1
12150	50 m · 13 mm	1

**FESTA****PANTLJIKA
ČELIČNA**

· Oko + kukica

CE II. class

Br.	Specifikacija	
12220	20 m · 10 mm	6
12230	30 m · 10 mm	6
12250	50 m · 10 mm	6



FESTA

PANTLJIKA ČELIČNA NA VILJUŠCI

· Oko



Br.	Specifikacija	
12433	30 m · 12,5 mm	20
12435	50 m · 12,5 mm	10



MERNI TOČAK

- resistant, light and compact
- counter attribute when moving forward and subtract when moving back
- built-in lighting - 2 x AAA batteries in handle
- Kesa



Br.	Specifikacija	
15989	max. 10 km	2



FESTA

**TELESKOPSKA
MERNÁ ŠIPKA**

· Kesa

Br.	Specifikacija	
15983	0,7 - 3 m	10
15985	1,1 - 5 m	10
15988	1,6 - 8 m	5



**SAMOLEPLJIVA
MERNÁ TRAKA**



Br.	Specifikacija	
11311	1 m · 12,5 mm	30
11312	2 m · 12,5 mm	30
11313	3 m · 16 mm	30
11314	5 m · 19 mm	30



METAR PRIVEZAK

Br.	Specifikacija	
11420	1 m · 6 mm narandžasta	24



FESTA

METAR PRIVEZAK

- Metar sa velikim ciframa
- Svojstva klasične merne trake



Br.	Specifikacija	
11410	2 m · 16 mm 6 boja	12



METAR PRIVEZAK

Br.	Specifikacija	
11444	1 m · 6 mm Beli	20



METAR PRIVEZAK

Br.	Specifikacija	
11425	1 m · 6 mm	25



LIBELA PRIVEZAK

Br.	Specifikacija	
11445		100

METAR DRVENI PREKLAPAJUĆI



Br.	Specifikacija	
13010	1 m · Beli	20
13020	2 m · Beli	10
13021	1 m · žuti	20
13022	2 m · žuti	10
13023	2 m · Belo - žuti	10

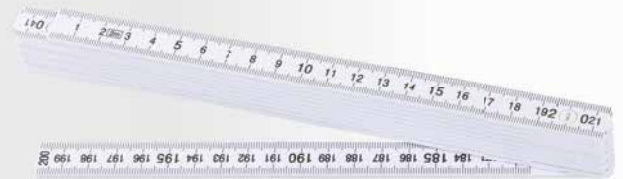
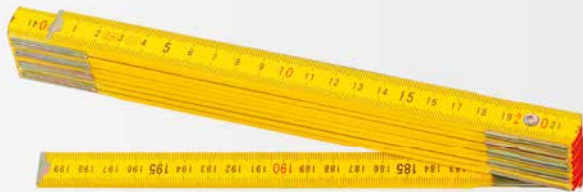

METAR DRVENI PREKLAPAJUĆI



Br.	Specifikacija	
13111	1 m · žuti	10
13120	2 m · žuti	5



METAR PLASTIČNI PREKLAPAJUĆI



Br.	Specifikacija	
13211	1 m	1
13220	2 m	1

METAR DRVENI SA IMENOM



Br.	Ime	Br.	Ime	Br.	Ime
13401	JIRÍ	13426	DANIEL	13451	JANA
13402	JAN	13427	ANTONÍN	13452	EVA
13403	PETR	13428	VOJTĚCH	13453	PETRA
13404	JOSEF	13429	FILIP	13454	MAJKA
13405	PAVEL	13430	ADAM	13455	HANA
13406	MARTIN	13431	MILOSLAV	13456	ANNA
13407	JAROSLAV	13432	MATĚJ	13457	LENKA
13408	TOMÁŠ	13433	ALEŠ	13458	KATKA
13409	MIROSLAV	13434	JAROMÍR	13459	LUCIE
13410	ZDENĚK	13435	LIBOR	13460	ALENA
13411	FRANTIŠEK	13436	DOMINIK	13461	VERONIKA
13412	VÁCLAV	13437	PATRIK	13462	MARTINA
13413	MICHAL	13438	VLASTIMIL	13463	JITKA
13414	MILAN	13439	JINDŘICH	13464	BIG BOSS
13415	KAREL	13440	MILOŠ	13465	2 x MĚŘ
13416	JAKUB	13441	JÁN	13466	TATÍNEK
13417	LUKÁŠ	13442	PETER	13467	DĚDEČEK
13418	DAVID	13443	ONDREJ	13468	ŠIKULA
13419	VLADIMÍR	13444	JOZEF	13469	MISTR
13420	LADISLAV	13445	PAVOL	13470	MACHR
13421	ONDŘEJ	13446	L'UBOMÍR	13471	BOREC
13422	ROMAN	13447	KAROL	13472	UŽ JE MŮJ
13423	STANISLAV	13448	RADOSLAV	13473	MŮJ METR
13424	MAREK	13449	VOJTĚCH		
13425	RADEK	13450	ZDENKO		

STALAK ZA METRE

· Ispunjen sa stavkama 13399

- 13401 · 15 kom
- 13402 · 15 kom
- 13403 · 15 kom
- 13404 · 15 kom
- 13405 · 15 kom
- 13406 · 15 kom
- 13412 · 15 kom
- 13413 · 15 kom
- 13414 · 15 kom
- 13415 · 15 kom
- 13416 · 15 kom
- 13417 · 15 kom
- 13418 · 15 kom
- 13419 · 15 kom
- 13420 · 15 kom
- 13421 · 10 kom
- 13422 · 10 kom
- 13423 · 10 kom
- 13424 · 10 kom
- 13425 · 10 kom
- 13426 · 10 kom
- 13427 · 10 kom
- 13428 · 10 kom
- 13429 · 10 kom
- 13430 · 10 kom
- 13431 · 10 kom
- 13432 · 10 kom
- 13433 · 10 kom
- 13434 · 10 kom
- 13435 · 10 kom
- 13436 · 10 kom
- 13437 · 10 kom
- 13438 · 10 kom
- 13439 · 10 kom
- 13440 · 10 kom



Br.	Specifikacija	
13399	Stalak za metre ispunjen	1
13400	Stalak za metre	1



FESTA

ŠUBLER DIGITALNI



INOX	Br.	Specifikacija	10
	14007	150 0,01 mm	10
	14008	200 0,01 mm	10
	14009	300 0,01 mm	10



ŠUBLER DIGITALNI

· Tačnost 0,2 mm, resolution 0,1 mm

Br.	Specifikacija	10
14013	150 0,2 mm	10

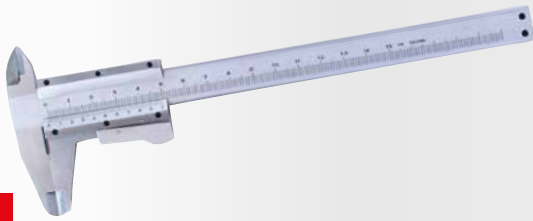

FESTA

ŠUBLER



INOX	Br.	Specifikacija	10
	14004	150 0,02 mm	10

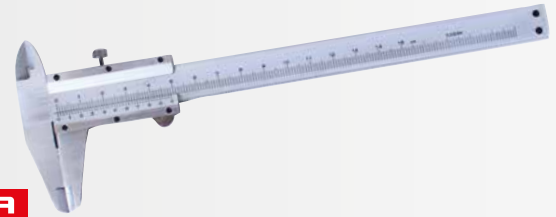

FESTA

ŠUBLER



INOX	Br.	Specifikacija	10
	14001	150 0,02 mm	10
	14002	200 0,02 mm	10
	14003	300 0,02 mm	10



FESTA

MIKROMETAR



Br.	Specifikacija	10
14040	0 - 0,25 0,01 mm	10
14045	25 - 50 0,01 mm	10



ŠUBLER

HOBBY

PLASTIC	Br.	Specifikacija	50
	14006	150 mm	50



FESTA

MERIL Odstupanja



INOX	Br.	Specifikacija	10
	14035	0 - 10mm 0,01 mm	10



MERNI LISTIĆI

· 20 listića

Br.	Specifikacija	10
14080	0,05 - 1 mm	10



ŠESTAR ZA OCRTAVANJE



Br.	Specifikacija	10
13285	200 mm	10



FESTA

ALAT ZA OBELEZAVANJE



Br.	Specifikacija	50
13281	150 mm	50



FESTA

ALAT ZA OBELEZAVANJE



Br.	Specifikacija	50
13282	200 mm	50

FESTA

LENJIR ALU

ALU

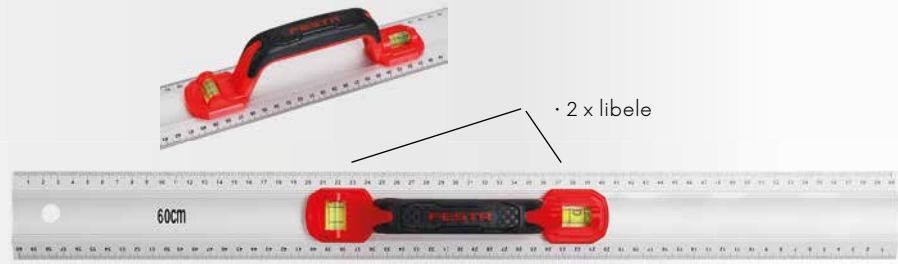

Br.	Specifikacija	
14030	600 mm	6

**FESTA**

LENJIR ALU

ALU



Br.	Specifikacija	
14015	400 mm	48
14017	600 mm	50
14019	1000 mm	40

**FESTA**

LENJIR METALNI INOX

INOX

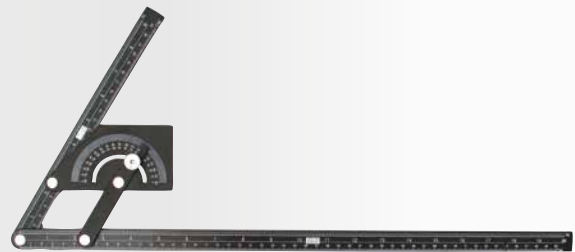
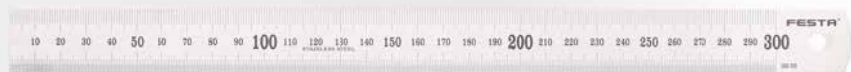

Br.	Specifikacija	
14010	300 mm	10
14011	600 mm	10
14012	1000 mm	10

**FESTA**

UGLOMER SA POMOČNIM RAMENOM

· Kesa

Br.	Specifikacija	
14060	0° - 180° · 150 x 200 mm	10
14070	0° - 180° · 300 x 500 mm	5

UGLOMER

HOBBY

Br.	Specifikacija	
14075	0° - 180° · 230 x 500 mm	30



VIŠENAMENSKI METAR

No.	Specification	
14077		10



10



VIŠENAMENSKI METAR



Br.	Specifikacija	
14480	250 x 120 mm	1



ŠABLON ZA KOPIRANJE OBLIKA



Br.	Specifikacija	
14090	125 x 30 mm	1
14091	250 x 30 mm	1

FESTA

UGAONIK 3D



Br.	Specifikacija	
14418		10



FESTA

UGAONIK BRAVARSKI



Br.	Specifikacija	
14420	180 mm	10
14421	300 mm	10

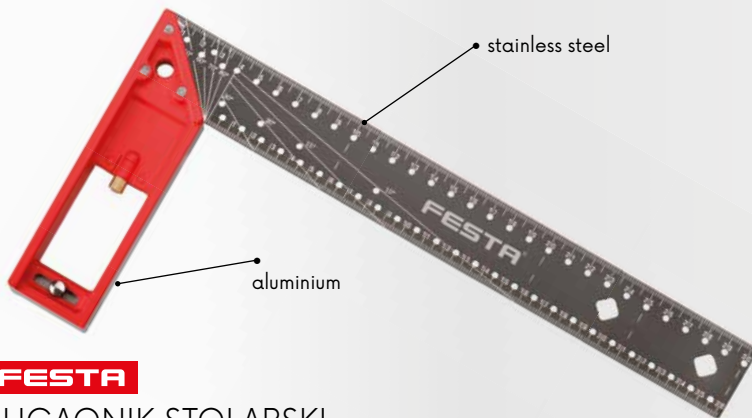

FESTA

UGAONIK STOLARSKI



No.	Specification	
14415	300 mm	6
14417	400 mm	6



FESTA
UGAONIK

ALU



Br.	Specifikacija	
14445	600 x 600 mm	1
14446	1200 x 1200 mm	1

FESTA
UGAONIK

ALU

Br.	Specifikacija	
14450	190 x 355 mm	6
14451	200 x 405 mm	6

FESTA
UGAONIK STOLARSKI

MADE IN EU

Br.	Specifikacija	
14220	200 x 125 mm	10
14225	250 x 135 mm	10
14230	300 x 135 mm	10
14235	350 x 190 mm	10
14240	400 x 190 mm	10
14250	500 x 210 mm	10

FESTA
UGAONIK STOLARSKI

MADE IN EU

Br.	Specifikacija	
14350	500 x 235 mm	10
14360	600 x 300 mm	10
14370	700 x 300 mm	10
14380	800 x 320 mm	10
14399	1000 x 360 mm	10

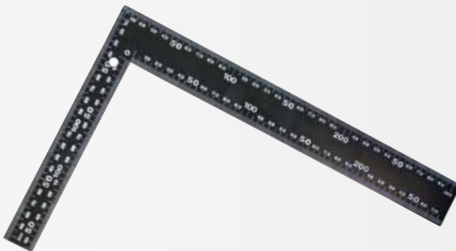

UGAONIK

Br.	Specifikacija	
14410	300 x 200 mm	50
14411	600 x 400 mm	36

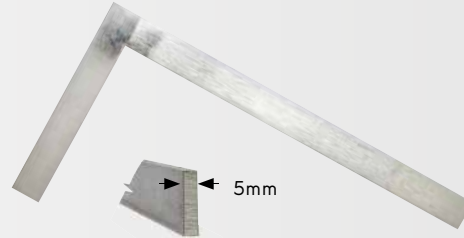

UGAONIK POCINKOVANI

Zn

Br.	Specifikacija	
14471	150 x 100 mm	25
14472	250 x 125 mm	25
14473	400 x 200 mm	30
14474	600 x 300 mm	25

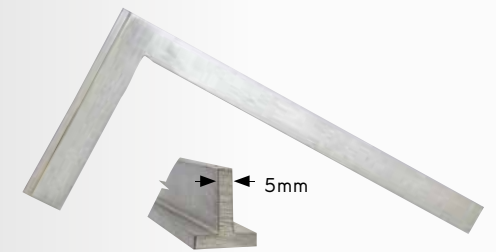

UGAONIK POCINKOVANI SA NASLONOM

Zn

Br.	Specifikacija	
14490	100 x 50 mm	10
14491	150 x 75 mm	10
14492	250 x 125 mm	10
14493	400 x 200 mm	10
14494	600 x 300 mm	10



UGAONIK

Br.	Specifikacija	
14455	300 x 200 mm	50
14456	500 x 250 mm	50
14457	700 x 300 mm	40
14458	1000 x 450 mm	30



UGAONIK BRAVARSKI

ALU HOBBY

Br.	Specifikacija	
14425	250 x 130 mm	12
14430	300 x 130 mm	12
14435	350 x 156 mm	12
14440	400 x 156 mm	12



UGAONIK

MADE IN EU

Br.	Specifikacija	
14025	255 x 285 mm	1

MADE IN EUROPE

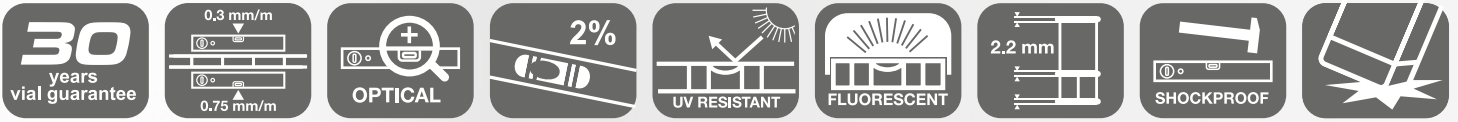

Svaki komad je elektronski testiran i ima svoj evidencioni broj, proizvođač je nosilac sertifikata ISO 9001.



HORIZONT[®]
MASTER



HORIZONT[®]
LIBELA MASTER 1/2

ALU			
Br.	Specifikacija		
15033	60 cm		10



HORIZONT[®]
LIBELA MASTER 1/3

ALU			
Br.	Specifikacija		
15034	80 cm		10
15035	100 cm		10



HORIZONT[®]
LIBELA MASTER 1/3

ALU			
Br.	Specifikacija		
15036	120 cm		10
15037	150 cm		10
15039	200 cm		10

HORIZONT®

MADE IN
EU

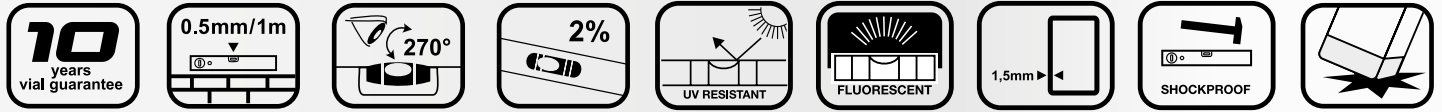

Svaki komad je elektronski testiran i ima svoj evidencioni broj, proizvođač je nosilac sertifikata ISO 9001.

HORIZONT® LIBELA, 2 LIBELE



Br.	Specifikacija	
15003	30 cm	30
15004	40 cm	30
15005	50 cm	30
15006	60 cm	30
15008	80 cm	30
15010	100 cm	30
15012	120 cm	10
15015	150 cm	10
15018	180 cm	10
15020	200 cm	10



HORIZONT® LIBELA, 3 LIBELE



Br.	Specifikacija	
15103	30 cm	30
15104	40 cm	30
15105	50 cm	30
15106	60 cm	30
15108	80 cm	30
15110	100 cm	30
15112	120 cm	10
15115	150 cm	10
15118	180 cm	10
15120	200 cm	10



HORIZONT® LIBELA 1/2 SA MAGNETOM



Br.	Specifikacija	
15204	40 cm	30
15205	50 cm	30
15206	60 cm	30
15208	80 cm	30
15210	100 cm	30
15212	120 cm	10
15215	150 cm	10
15218	180 cm	10
15220	200 cm	10



HORIZONT® LIBELA NAGIBNA 1/4



Br.	Specifikacija	
15230	80 cm	10



HORIZONT LIBELA NASLONSKA



Br.	Specifikacija	
15235	60 cm	1



HORIZONT LETVA ZIDARSKA

ALU

Br.	Specifikacija	
15310	100 cm	10
15315	150 cm	10
15318	180 cm	10
15320	200 cm	10
15325	250 cm	10
15330	300 cm	10
15335	350 cm	10
15340	400 cm	10



HORIZONT LETVA ZIDARSKA SA LIBELOM

ALU

Br.	Specifikacija	
15415	150 cm	10
15418	180 cm	10
15420	200 cm	10
15425	250 cm	10
15430	300 cm	10



HORIZONT LETVA ZIDARSKA SA LIBELOM 1/2

ALU

Br.	Specifikacija	
15510	100 cm	10
15515	150 cm	10
15518	180 cm	10
15520	200 cm	10
15525	250 cm	10
15530	300 cm	10
15535	350 cm	10
15540	400 cm	5



HORIZONT LETVA ZIDARSKA SA 2 RUKOHVATA

ALU

Br.	Specifikacija	
15615	150 cm	10
15620	200 cm	10
15625	250 cm	10
15630	300 cm	10



HORIZONT**LETVA ZIDARSKA SA 2 RUKOHVATA +2 LIBELE**

ALU

Br.	Specifikacija	
15710	100 cm	10
15715	150 cm	10
15720	200 cm	10
15725	250 cm	10
15730	300 cm	10
15735	350 cm	10
15740	400 cm	5

**HORIZONT****LETVA ZIDARSKA TRAPEZ**

PROFILE TRAPEZOIDAL

- trapezoidal profile for finer surface finishes
- suitable for stuccoers and facades
- suitable for thin-film plasters

ALU

Br.	Specifikacija	
15810	100 cm	10
15812	120 cm	10
15815	150 cm	10
15818	180 cm	10
15820	200 cm	10
15825	250 cm	10
15830	300 cm	10

**HORIZONT****LETVA ZIDARSKA „h“ PROFIL**

PROFILE "h"

- "h" profile for finer surface finishes
- suitable for stuccoers and facades
- suitable for stucco plastering

ALU

Br.	Specifikacija	
15850	100 cm	10
15853	150 cm	10
15855	180 cm	10
15860	200 cm	10
15870	250 cm	10
15880	300 cm	10

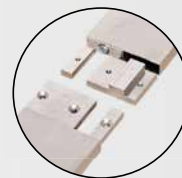

NEW

HORIZONT**KVAČILO ZA ZIDARSKÉ LETVE HORIZONT**

Br.	Specifikacija		
15301		1	

**HORIZONT****LETVA ZIDARSKA SA LIBELOM PODESIVA**

Br.	Specifikacija	
15893	65 - 100 cm	1
15894	95 - 150 cm	1
15895	145 - 235 cm	1

**HORIZONT****UGAONIK**

ALU

Br.	Specifikacija	
14485	800 x 1200 mm	1
14486	1000 x 1500 mm	1



HORIZONT.
REKLAMNA POLICA
ZA LIBELE HORIZONT

· Ispunjen sa stavkama 15998

- 15003 · 5 kom
- 15004 · 5 kom
- 15005 · 5 kom
- 15006 · 5 kom
- 15008 · 5 kom
- 15010 · 5 kom
- 15012 · 5 kom
- 15015 · 3 kom
- 15018 · 3 kom
- 15020 · 3 kom
- 15108 · 3 kom
- 15206 · 3 kom
- 15210 · 3 kom

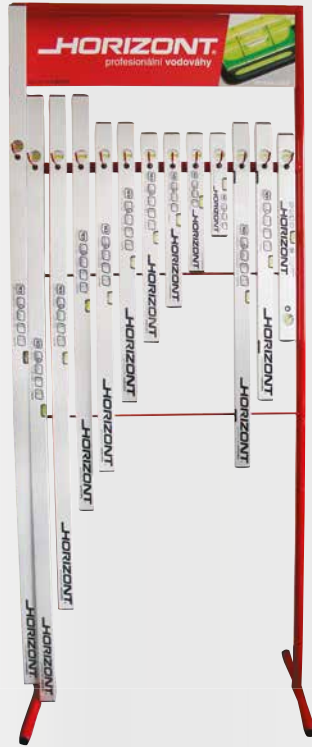

HORIZONT.
REKLAMNA POLICA
ZA LIBELE HORIZONT

· Ispunjen sa stavkama 15996

- 15004 · 5 kom
- 15005 · 5 kom
- 15006 · 5 kom
- 15008 · 5 kom
- 15010 · 5 kom
- 15012 · 5 kom
- 15015 · 5 kom
- 15018 · 5 kom
- 15020 · 5 kom
- 15315 · 2 kom
- 15320 · 2 kom
- 15325 · 3 kom
- 15515 · 2 kom
- 15520 · 2 kom
- 15525 · 3 kom



Br.	Specifikacija	
15999	85 x 210 x 50 cm	1
15998	85 x 210 x 50 cm sa libeli i letvi	1

Br.	Specifikacija	
15997	55 x 75 x 40 cm	1
15996	55 x 75 x 40 cm sa libeli i letvi	1

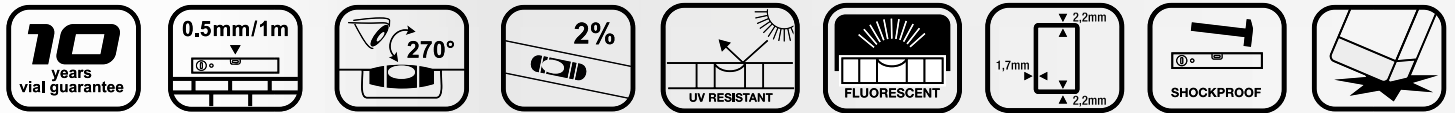

NEW

FESTA
LIBELA 1/3



Br.	Specifikacija	
15754	400 mm	1
15756	600 mm	1
15758	800 mm	1
15760	1000 mm	1
15762	1200 mm	1
15768	1800 mm	1
15770	2000 mm	1



LIBELA 1/2

- Tačnost 0,5 mm | 1 m (u normalnom položaju)
- Tečnost u bocici je UV otporan
- Gumeni završetak, otporan na udarce
- Debljina, grim profil 1,2 mm



Br.	Specifikacija	
15904	40 cm	30
15906	60 cm	30
15908	80 cm	30
15910	100 cm	30
15912	120 cm	20
15915	150 cm	10
15920	200 cm	20



LIBELA 1/3

ALU HOBBY

Br.	Specifikacija	
15954	40 cm	60
15956	60 cm	60
15958	80 cm	60
15960	100 cm	30
15962	120 cm	30
15965	150 cm	30
15970	200 cm	30



LIBELA ZA KANAP



Br.	Specifikacija	
15981		1



Br.	Specifikacija	
15980	230 mm	1

LIBELA 1/3 SA MAGNETOM

LIBELA ZA ŠTAPOVE

- 3 libele, magnet, traka za učvršćivanje



Br.	Specifikacija	
26028		12



CREVASTA LIBELA



Br.	Specifikacija	
15992	Staklena cjevčica- crijevo 10 m	1
15993	Staklena cjevčica- crijevo 10 m	1
15990	Staklena cjevčica	50
15991	Plastična cjevčica	50



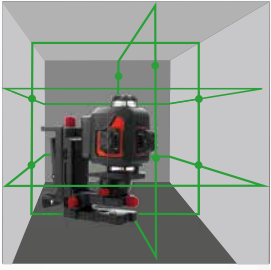

NEW

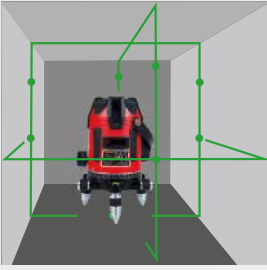

NEW



FESTA

LASER ALL LINE GREEN 4 X 360 °

- 2k horizontalna ravan + 2k vertikalna ravan (zeleni snop)
- samonivelirajući opseg $\pm 4^\circ$
- tačnost: 0,2 mm/m
- u zatvorenom prostoru 30 m, sa laserskim prijemnikom do 50 m
- pulsni režim – preporučeni dodatni prijemnik 26209
- isporučuje se sa: transportnom torbicom, daljinskim upravljačem, laserskom metom, Li-jonska baterija 5200 mAh, profesionalni držač, mini stativ, punjač

FESTA

CROSS-LINE GREEN LASER

- 1k horizontalna ravan + 4k vertikalna ravan (zeleni snop) + 1k tačka
- samonivelirajući opseg $\pm 3^\circ$
- tačnost: 0,2 mm/m
- u zatvorenom prostoru 20 m, sa laserskim prijemnikom do 50 m
- pulsni režim – preporučeni dodatni prijemnik 26209
- isporučuje se sa: transportnom torbicom, laserskom metom, Li-jonska baterija 5200 mAh, profesionalni držač, mini stativ, punjač

$\pm 4^\circ$	max. 50 m	± 0.2 mm/m	II. class	515 nm
1/4"	5/8"	IP54	Li-ion 3.7V 5.2Ah	



Br. 26205 Specifikacija

1

$\pm 3^\circ$	max. 50 m	± 0.2 mm/m	II. class	515 nm
5/8"	IP54	Li-ion 3.7V 5.2Ah		



Br. 26203 Specifikacija

1



**FESTA****LASER ALL LINE GREEN 3 X 360 °**

- 1k horizontalna ravan + 2k vertikalna ravan (zeleni snop)
- samonivelirajući opseg $\pm 4^\circ$
- tačnost 0,2 mm/m
- unutrašnja: 30 m, spoljašnja sa detektorom 50 m
- pulsni režim – preporučeni dodatni prijemnik 26209
- uključeno: torbica, 4kAA alkalne baterije, laserska meta, zaštitne naočare, 2600 mAh Li-ion baterija, profesionalni nosač, punjač, postolje Li-ion baterije

$\pm 4^\circ$	INDOOR 30 m OUTDOOR 50 m	± 0.2 mm/m	II. class	515 nm
IP54	5/8"	1/4"	4x AA	Li-ion 7.4V 2.6Ah



Br. Specifikacija

26204

1

**FESTA****CROSS-LINE GREEN LASER**

- 1k horizontalna ravan + 1k vertikalna ravan (zeleni snop)
- samonivelirajući opseg $\pm 3^\circ$
- tačnost 0,2 mm/m
- unutrašnja: 20 m, spoljašnja sa detektorom 50 m
- pulsni režim – preporučeni dodatni prijemnik 26209
- Uključeno: torbica za nošenje, 2kAA alkalne baterije, nosač

$\pm 3^\circ$	INDOOR 20 m OUTDOOR 50 m	± 0.2 mm/m	II. class	515 nm
IP54	1/4"	2x AA		

Br. Specifikacija

26201

1

FESTA**DALJINOMER**

- merni opseg 0,05 - 50 m
- tačnost merenja ± 2 mm, merna jedinica mm/in/ft
- kontinuirano merenje, merenje površine, merenje zapremine, Merenje noge trougla, LCD FSTN, sabiranje/oduzimanje, maks./min. meas urement, mak skladištenje 100 jedinica, pozadinsko osvetljenje, klasa lasera 630-670 nm klasa 2
- radna temperatura 0 - 40°C
- veličina 112 k 50 k 25 mm, težina 90 g
- uključujući: torbicu za nošenje, 2kAAA alkalne baterije

max 50 m	± 2 mm	m in ft	630 670 nm
IP54	2x AAA		

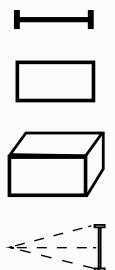

Br. Specifikacija

26211

1



FESTA

LASERSKI PRIJEMNIK

- za upotrebu sa impulsnim laserskim uređajima za proširenje dometa od 50 m
- uključujući: 9 V baterija, nosač
- za 26201, 26203, 26204, 26205

max 50 m	±1.5 mm 10 m	5 kHz	IP54	1x 9V
--------------------	------------------------	--------------	-------------	--------------

Br.	Specifikacija	1
26209	range: 50 m	1

1/4" + 5/8"



60 - 150 cm

TRONOŽAC

ALU

Br.	Specifikacija	1
26219	60 - 150 cm 1/4" + 5/8"	1

FESTA

DIGITALNI INCLINOMETAR

- 0° - 360°
- Tačnost ±0,1°
- Rezolucija 0,1°
- Funkcija automatskog isključivanja
- HOLD funkcija za čuvanje izmerene vrednosti
- Ekran sa pozadinskim osvetljenjem
- Dimenzije 60x60x25 mm
- Baterija 1xAAA



· bag

· Magnetska donja strana

84.5° LCD DISPLAY	1x AAA	0-50°C	82 g
-----------------------------	---------------	---------------	-------------

Br.	Specifikacija	1
26218		1



FESTA

DIGITALNI PROTRACTOR

200 mm	mm inch	LCD DISPLAY	0°-360°
0.05°	+/- 0.2°	MANUAL LOCKING	1x CR2032 3V

Br.	Specifikacija	1
26217	200 mm	1



FESTA

DIGITALNI PROTRACTOR

- LCD
- Merni opseg 0° - 225°
- Razlika 0,1°
- Tačnost ± 0,3

ALU	044.8° LCD DISPLAY	3V LITHIUM
------------	------------------------------	-------------------

Br.	Specifikacija	1
26216	300 mm	1

FESTA**MULTIMETAR**

Merenje jednosmernog napona: 200 mV - 300 V
 Merenje naizmeničnog napona: 200 mV - 300 V
 Merenje jednosmerne struje: 2000 mA - 10 A
 · merenje otpora: 200 Ω - 2 MΩ
 · provera baterije: 1,5 V, 9 V
 · indikacija slabe baterije
 · zaštita od preopterećenja

- IEC61010
- CATIII 300 V
- GS sertifikat
- napajanje: 9 V baterija (6F22)
- dimenzije: 70×128×28 mm
- težina: 137 g (sa baterijom)
- pribor: ispitni kablovi



Br. Specifikacija
18429



1

**FESTA****TESTER NAPONA**

AC/DC - 6V, 12V, 24V, 50V, 120V, 230V, 400V
 · vodootpornost IP54
 · određivanje polariteta
 · CAT III 400V



Br. Specifikacija
18428



1

**Laserliner®****LUXTEST-MASTER**

Professional lighting intensity measuring instrument

- Measurement of lighting intensity in workplaces, offices, public buildings and industry
- Sensitive photodiode with cosine correction for wide-angle light measurement
- Relative measurement function for reference and comparison measurement
- Peak function for registering fast changes in light levels
- Hold function
- Automatic and manual range changeover
- Zeroing function
- Measurement variables: Lux (lm /m²), foot candle (lm /ft²)
- Min |Max display
- 1 |4" tripod connection



Br. Specifikacija

	Measuring range	20 Lux ... 200000 Lux
26520	Lux accuracy	± 3% (референтна стойност 2854 K) (reference light bulb at 2854 K)
	Cosine angular deviation:	± 2% (30°), ± 6% (60°)



1

Specifikacija

Inclusive: battery, carrying case

Laserliner®**AIRFLOWTEST-MASTER**

Professional anemometer for measuring air flow, volumetric flow and wind speed

- Integrated sensor for measuring ambient temperature, relative humidity and dew point calculation
- USB interface for saving measured data
- PC software for real-time logging
- Large impeller: 65 mm
- Min |Max display
- 1 |4" tripod connection for long-term measurement
- Illuminated, clearly arranged display with permanently visible ambient temperature and relative humidity



Br. Specifikacija

	Flow rate:	0.80...30 m s ± 2%
26521	Ambient temperature	-10...60°C ± 1.5°C
	Relative humidity:	20%...80% ± 3%
	Airflow :	0...99990 CMM



RECORDING ON A PC

Specifikacija

Inclusive: PC software, USB Cable, batteries, carrying case



1



FESTA

OLOVKA TESARSKA HB



MOQ
12

Br.	Specifikacija	MOQ
13270	HB · 180 mm	96
13271	HB · 180 mm · set 3pcs	32
13265	HB · 250 mm	96



FESTA

OLOVKA TESARSKA HB



MOQ
50

Br.	Specifikacija	MOQ
13269	HB · 180 mm	50
13266	HB · 250 mm	50



FESTA

OLOVKA TESARSKA HB



MOQ
12

Br.	Specifikacija	MOQ
13272	HB · 250 mm	96
13264	HB · 250 mm · bez štampe	96



FESTA

OLOVKA TESARSKA HB



MOQ
50

Br.	Specifikacija	MOQ
13268	250 mm	50



FESTA

TROUGLASTA OLOVKA HB



MOQ
12

Br.	Specifikacija	MOQ
13278	250 mm	96



FESTA

OLOVKA ZA KAMEN 6H

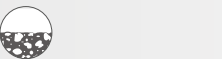

MOQ
12

Br.	Specifikacija	MOQ
13275	6H · 250 mm	96



FESTA

CRVENA OLOVKA ZA STAKLO I KARAMIKU



MOQ
12

Br.	Specifikacija	MOQ
13273	175 mm crvena olovka za staklo i karamiku	144



FESTA

OLOVKA

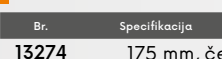

MOQ
12

Br.	Specifikacija	MOQ
13274	175 mm, červeno - plava	96



OLOVKA TESARSKA HB

MOQ
12

Br.	Specifikacija	
13280	180 mm	96



OLOVKA

MOQ
12

Br.	Specifikacija	
13276	175 mm	144



Brusni papir

OŠTRAČ ZA OLOVKE



Br.		
13261		12



FESTA

ALAT ZA OBELEŽAVANJE HB

· olovke 13263, 13267



Br.	Specifikacija	
13288		20



FESTA

ALAT ZA OBELEŽAVANJE HB

· olovke 13263, 13267

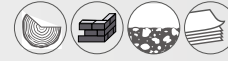

Br.	Specifikacija	
13262	150 mm	20



· oštrač za olovke



FESTA

OLOVKA ZA OBELEŽAVANJE HB



Br.	Specifikacija	
13279	pencil + olovke HB	24
13284	olovke 5 pcs	20

FESTA

OLOVKE U BOJI

· pro 13262, 13288



Č.p.	Specifikacije	
13267	● 2x žuti ● 2x Crveni ● 2x Plavi	1

FESTA

CRNE OLOVKE HB

· pro 13262, 13288



Č.p.	Specifikacije	
13263	● 6x černá	20





PERMANENTNI MARKER



Br.	Specifikacija	
13200	○ Beli	1
13201	● Crni	1
13202	● Crveni	1

NEW



PERMANENTNI MARKER



- Ekstra jak vrh
- Za obeležavanje čak i na masnim i mokrim površinama



MOQ 12

Br.	Specifikacija	
13216	Crveni	12
13217	Crni	12
13218	Plavi	12
13219	Zelen	12



PERMANENTNI MARKER



- 2 tipa vrha markera
- Za obeležavanje čak i na masnim i mokrim površinama



Br.	Specifikacija	
13227	Beli ALU	40
13222	Beli PVC	12
13228	Crveni ALU	40
13229	Crni ALU	40
13230	Plavi ALU	12
13231	Zelen ALU	12



PERMANENTNI MARKER



MOQ 12



Br.	Specifikacija	
13214	Beli	12
13225	Crveni	12
13226	Crni	12
13223	Plavi	12
13224	Zelen	12



PERMANENTNI MARKER



MOQ 12



Br.	Specifikacija	
13235	Crveni	12
13236	Crni	12
13237	Plavi	12
13238	Zelen	12



FESTA

PERMANENTNI MARKER



Br.	Specifikacija	
13246	● Crni	1
13247	● Crveni	1
13248	○ Beli	1



PERMANENTNI MARKER, 2 TIPA VRHA

MOQ 12



Br. I No.	Specifikacija	
13206	○ Beli	12



PERMANENTNI MARKER, 2 TIPA VRHA

MOQ 12



Br.	Specifikacija	
13212	● Crni	12



PERMANENTNI MARKER, 2 TIPA VRHA

MOQ 12



Br.	Specifikacija	
13207	● Crveni	12
13208	● Plavi	12



PERMANENTNI MARKER MINI



• Dužina 9 cm



MOQ 72

Br.	Specifikacija	
13205	● ● ● ● ●	72



FESTA

**KOMPLET OLOVAKA
5 KOM**
· Ø 13 x 110 mm

5x



Br.	Specifikacija	
13240	5 boja	20
13241	● Crveni	20
13242	● Crni	20

Br.	Specifikacija	
13243	● Žut	20
13244	● Zelen	20
13245	○ Beli	20



DRŽAČ ZA SPREJ

· For spray trackmarker and Fluo



Br.	Specifikacija	
13296		1



**KOMPLET OLOVAKA
6 KOM**

6x



Br.	Specifikacija	
13277	● ● ● ● ● ●	88



KREDA BELA

12x



Br.	Specifikacija	
13260	12 x 12 x 80 mm	46



DRŽAČ SPREJA SA PIŠTOLJEM

· For spray trackmarker and Fluo



Br.	Specifikacija	
13295		1



FLUORESCENTNI SPREJ TRACKMARKER 500ML

- Dobra vidljivost zbog fluorescentnog pigmenta
- Bezbednost kapa
- Brzo sušenje 10 min.
- Trajnost 3 mesecis
- Primena - beton, asfalt, trava, šljunak, pesak, kamen, drvo



Br.	Specifikacija	
13250	žuti	12
13251	Crveni	12
13252	narandžasta	12
13253	Zelen	12
13254	Roze	12
13249	Plavi	12



FLUORESCENTNI SPREJ MARK 6M FLUO 500 ML

- Dobra vidljivost zbog fluorescentnog pigmenta
- Bezbednost kapa
- Brzo sušenje 10 min.
- Trajnost 12 mesecis
- Primena - beton, asfalt, trava, šljunak, pesak, kamen, drvo



Br.	Specifikacija	
13360	žuti	12
13361	Crveni	12
13362	narandžasta	12
13363	Zelen	12
13364	Roze	12
13365	Beli	12



FLUORESCENTNI SPREJ FLUO 500 ML

- Dobra vidljivost zbog fluorescentnog pigmenta
- Bezbednost kapa
- Brzo sušenje 10 min.
- Trajnost 12 mesecis
- Primena - beton, asfalt, trava, šljunak, pesak, kamen, drvo



Br.	Specifikacija	
13350	žuti	12
13351	Crveni	12
13352	narandžasta	12
13353	Zelen	12
13354	Roze	12
13355	Beli	12



FLUORESCENTNI SPREJ IDEAL 500ML

- Dobra vidljivost zbog fluorescentnog pigmenta
- Bezbednost kapa
- Brzo sušenje 10 min.
- Trajnost 12 mesecis
- Primena - beton, asfalt, trava, šljunak, pesak, kamen, drvo



Br.	Specifikacija	
13255	žuti	12
13256	Crveni	12
13257	narandžasta	12
13258	Zelen	12
13259	Roze	12



KDS®

Noževi japanske firme KDS

- Izvrsna ergonomska drška
- Visokokvalitetne i dugotrajne oštrice
- Najbolji korišteni materijali u izradi
- Mali otpor rezanja omogućuje lagano rezanje

**KDS®**
SKALPER

Br.	Specifikacija		
16002	LC405 18 mm zeleni	25	
16011	LB10 Rezervno sečiva	10	

**KDS®**
SKALPER

Br.	Specifikacija		
16003	G11 18 mm + 2 sečiva	10	
16012	GB10 Rezervno sečiva	10	

**KDS®**
SKALPER

Br.	Specifikacija		
16019	L19 18 mm + 2 sečiva	10	
16011	LB10 Rezervno sečiva	10	
16012	GB10 Rezervno sečiva	10	

**KDS®**
SKALPER

Br.	Specifikacija		
16004	H11 25 mm	10	
16013	HB10 Rezervno sečiva	10	

**KDS®**
SKALPER

Br.	Specifikacija		
16005	S14 9 mm + 2 sečiva	10	
16010	SB10 Rezervno sečiva	10	

**KDS®**
SKALPEL

Br.	Specifikacija		
16006	D12 + 16 sečiva	10	

KDS®
REZERVNO SEČIVO KDS

Br.	Specifikacija		
16010	SB10 9 0,38 mm	13 segmenata	20
16011	LB10 18 0,5 mm	15 segmenata	20
16012	GB10 18 0,6 mm	15 segmenata	20
16013	HB10 25 0,7 mm	7 segmenata	10

**KDS®**
REZERVNO SEČIVO KDS

- Specijalna legura
- Dvoji brašeni
- Poboľšan životni vek
- Niska otpornost na sečenje
- Omogućava lako sečenje



Br.	Specifikacija		
16016	LB10B 18 0,5 mm	8 segmenata	20
16017	HB10B 25 0,7 mm	7 segmenata	10

**KDS®**
REKLAMNA POLICA

Br.	Specifikacija		
16999	Reklamni stalak	1	
16998	Reklamni stalak sa noževima	1	



- Sadrži 16998 : 16001 · 5 kom
- 16003 · 5 kom
- 16004 · 3 kom
- 16005 · 3 kom
- 16006 · 2 kom
- 16008 · 3 kom
- 16010 · 4 kom
- 16012 · 4 kom
- 16013 · 1 kom
- 16016 · 4 kom
- 16018 · 4 kom
- 16019 · 4 kom
- 16020 · 4 kom

· ilustracija fotografija



FESTA



sistem za lomljenje sečiva



FESTA
INDUSTRY

SKALPER

· Gumena drška protiv klizanja



Br.	Specifikacija	
16099	18 mm	12

FESTA



FESTA

SKALPER SA KERAMIČKIM SEČIVOM

· 3x sharper than the steel blade
· 10x longer lifetime
· Refractory, non-conductive, non-magnetic



Br.	Specifikacija	
16131	18 mm	10
16066	Rezervno sečivo 18 mm, 5 kom	10

FESTA

SKALPER



Br.	Specifikacija	
16110	L11 18 mm + 1 sečivo	12

FESTA

SKALPER



Br.	Specifikacija	
16100	L12 18 mm + 1 sečivo	12

FESTA

SKALPER



Br.	Specifikacija	
16105	L17 18 mm + 1 sečivo	12

FESTA

SKALPER



Br.	Specifikacija	
16125	L4 9 mm	24
16120	L8 18 mm	24

FESTA

SKALPER



Br.	Specifikacija	
16115	L10 9 mm	24

**FESTA**

SKALPER

ALU

Br.	Specifikacija	
16150	18 mm	24
16151	18 mm Bez štampanja	20

**FESTA**

SKALPER

ALU

Br.	Specifikacija	
16136	18 mm	12

**FESTA**

SKALPER

ALU

Br.	Specifikacija	
16137	25 mm	12

**FESTA**

SKALPER

• Gumena drška protiv klizanja

+4 ALU

Br.	Specifikacija	
16090	18 mm	12

**FESTA**

SKALPER

• Gumena drška protiv klizanja

+4 ALU

Br.	Specifikacija	
16091	25 mm	6

**FESTA**

SKALPER

• Gumena drška protiv klizanja

ALU

Br.	Specifikacija	
16145	L25 18 mm	12

**FESTA**

SKALPER

• Gumena drška protiv klizanja

ALU

Br.	Specifikacija	
16144	L24 18 mm	12



SKALPER

ALU

Br.	Specifikacija	
16143	18 mm	12



SKALPER

ALU

Br.	Specifikacija	
16142	18 mm	12



SKALPER

ALU

Br.	Specifikacija	
16025	18 mm	12

**FESTA**

SKALPER

ALU

Br.	Specifikacija	
16029	18 mm	25

**FESTA**

SKALPER

• Gumena drška protiv klizanja

ALU

Br.	Specifikacija	
16146	18 mm	12



FESTA

SKALPER

• Gumena drška protiv klizanja



Br.	Specifikacija	12
16147	25 mm	



FESTA

SKALPER

• Gumena drška protiv klizanja



Br.	Specifikacija	12
16130	L18 18 mm + 5 sečivo	



FESTA

SKALPER

• Gumena drška protiv klizanja



Br.	Specifikacija	6
16135	L20 25 mm + 5 sečivo	



FESTA

SKALPER

• Gumena drška protiv klizanja



Br.	Specifikacija	12
16140	L22 18 mm	



FESTA

SKALPER

• Gumena drška protiv klizanja



Br.	Specifikacija	12
16034	25 mm	



FESTA

SKALPER

• samo-uvlačea sečivo



Br.	Specifikacija	24
16085	9 mm	



FESTA

SKALPER

• samo-uvlačea sečivo



Br.	Specifikacija	24
16086	18 mm	



SIGURNOSNI NOŽ



Br.	Specifikacija	20
16044		



SIGURNOSNI NOŽ

• samo-uvlačea sečivo

Br.	Specifikacija	12
16057	135 mm	



FESTA

SIGURNOSNI NOŽ

ALU INOX



Br.	Specifikacija	6
16058		
16074	Rezervno sečivo 10 kom	1

16074



NEW



FESTO

SKALPER

+2 SK4



Br.	Specifikacija	
16039		6
16087	Rezervno sečivo	1



FESTO

SKALPER

+5 ALU



Br.	Specifikacija	
16037	+ 5 sečivo	6

FESTO

SKALPER

+5 ALU



Br.	Specifikacija	
16023	+ 5 sečivo	12
16071	Rezervno sečivo 10 kom	10

FESTO

SKALPER KOMPLET

ALU

Br.	Specifikacija	
16095	25 sečivak	1



SKALPELI

22x



Br.	Specifikacija	
16282		24



SKALPELI

13x



Br.	Specifikacija	
16281		10



FESTO

SKALPER SA ARETACIJOM

• Gumena drška protiv klizanja

ALU +2



Br.	Specifikacija	
16035	+ 2 sečivo	12



FESTO

SKALPER SA ARETACIJOM

ALU +3



Br.	Specifikacija	
16033	NP 110 + 3 sečivo	5





SKALPER SA ARETACIJOM

ALU



Br.	Specifikacija	
16032	NP 109	48



SKALPER SA ARETACIJOM

ALU

Br.	Specifikacija	
16031	NS 107 B	24



SKALPER

ALU

Br.	Specifikacija	
16030	NS 107	24



SKALPER

ALU



Br.	Specifikacija	
16046	18 mm	12



SKALPER

Br.	Specifikacija	
16028	S 201 18 mm	24



SKALPER

Br.	Specifikacija	
16026	P 205 18 mm	30



SKALPER

HOBBY

Br.	Specifikacija	
16021	P 201 9 mm	60

SKALPER

HOBBY

Br.	Specifikacija	
16024	P 204 18 mm	60

SKALPER

· Gumena drška protiv klizanja

Br.	Specifikacija	
16141	18 mm	24

MOQ
24

SKALPER KOMPLET

HOBBY

12x

Br.	Specifikacija	
16053	9 mm	12
16055	18 mm	12

SKALPER KOMPLET

HOBBY

3x

Br.	Specifikacija	
16043		24





NOŽ ZA TEPIH I LINOLEUM

· za tepih i linoleum



Br.	Specifikacija	
16036	45 mm	12



KUKASTI NOŽ

· za tepih i linoleum



Br.	Specifikacija	
16041		12



50 mm

STRUGALICA

ALU



Br.	Specifikacija	
16059	50 mm	10
16082	Rezervno sečivo	1



100 mm

STRUGALICA

· za upotrebu sa oštricama od 18 mm za skalper

ALU



Br.	Specifikacija	
16054	100 mm	1



100 mm

PRODUŽENI STRUGAČ STAKLA



Br.	Specifikacija	
16052	48 cm dužina	6
16070	sečivo	25



38 mm

FESTA

STRUGALICA

· Gumena drška protiv klizanja



Br.	Specifikacija	
16049		12
16069	Rezervno sečivo	1



60 mm

STRUGALICA



Br.	Specifikacija	
16051		24



55 mm

STRUGALICA



Br.	Specifikacija	
16050		24



SET SCRAPERS ZA PRIMENU I UKLANJANJE SILIKONA

3x



Br.	Specifikacija	
16042		12





FESTA

REZERVNO SEČIVO

- 7 segmenata
- 3x duži životni vek
- duplo brušenje
- mali otpor rezanja



Br.	Specifikacija	
16064	25 0,7 mm	20

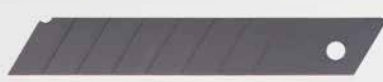

FESTA

REZERVNO SEČIVO

- 8 segmenata
- 3x duži životni vek
- duplo brušenje
- mali otpor rezanja



Br.	Specifikacija	
16062	18 0,7 mm	10



FESTA

REZERVNO SEČIVO

- 15 segmenata
- 3x duži životni vek
- duplo brušenje
- mali otpor rezanja

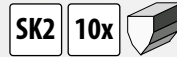

Br.	Specifikacija	
16063	18 0,7 mm	10



FESTA

REZERVNO SEČIVO
KERAMIČKO

- 8 segmenata
- 3x sharper than the steel blade
- 10x duži životni vek
- Refractory, non-conductive, non-magnetic



Br.	Specifikacija	
16066	18 0,6 mm	10



REZERVNO SEČIVO

- 8 segmenata
- Duplo brušenje



Br.	Specifikacija	
16078	18 0,5 mm	25



REZERVNO SEČIVO

- 8 segmenata
- Duplo brušenje



Br.	Specifikacija	
16077	18 0,6 mm	25



REZERVNO SEČIVO

- 7 segmenata



Br.	Specifikacija	
16068	25 0,6 mm	20



REZERVNO SEČIVO

- 8 segmenata



Br.	Specifikacija	
16065	18 0,5 mm	60



REZERVNO SEČIVO

- 15 segmenata



Br.	Specifikacija	
16081	18 0,5 mm	60



REZERVNO SEČIVO

- 4 segmenata



Br.	Specifikacija	
16067	18 0,5 mm	10



REZERVNO SEČIVO

- 7 segmenata



Br.	Specifikacija	
16061	9 0,4 mm	60



REZERVNO SEČIVO

- 13 segmenata



Br.	Specifikacija	
16060	9 0,45 mm	10



FESTA

REZERVNO SEČIVO



Br.	Specifikacija	
16072	R 004	10



FESTA

REZERVNO SEČIVO



Br.	Specifikacija	
16075	R 003	10



FESTA

REZERVNO SEČIVO



Br.	Specifikacija	
16071	R 001	60



REZERVNO SEČIVO

5x

Br.	Specifikacija	
16083	18 mm	50



REZERVNO SEČIVO

10x

Br.	Specifikacija	
16073	R 002	60



REZERVNO SEČIVO

5x

Br.	Specifikacija	
16084	18 mm	50

FESTA

REZERVNO SEČIVO

· Za 16058

10x

Br.	Specifikacija	
16074		1



REZERVNO SEČIVO

· Za 34315

Br.	Specifikacija	
34316		1



REZERVNO SEČIVO

· Za 16052

Br.	Specifikacija	
16070	100 mm	25

**FESTA**

REZAČ MINERALNE VUNE

Br.	Specifikacija	
16198	44,5 33 cm	12

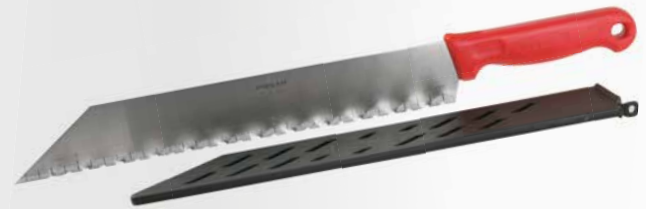
**FESTA**

NOŽ ZA IZOLACIJU

· Nož od mineralne vune, polistiren

Br.	Specifikacija	
16199	48 35 cm	10

**FESTA**

MAČETA

Br.	Specifikacija	
45069	490 mm	6

**FESTA**

MAČETA SA ZUBCIMA

Br.	Specifikacija	
44950	490 mm	4



MAČETA ROSTFREI

Br.	Specifikacija	
45083	430 mm	12
45084	600 mm	6



MAČETA

· Drška od jasena

Br.	Specifikacija	
45081	510 mm	36
45082	710 mm	36



FESTA

LOVAČKI NOŽ

- Najlonska drška
- Sečivo sa teflonskom površinom
- Futrola sa osiguračem i kopčom



INOX	TEFLON	NYLON	Br.	Specifikacija	
			16234	21 10 cm	10



FESTA

LOVAČKI NOŽ



INOX	TEFLON	Br.	Specifikacija	
		16229	23 10 cm	12



FESTA

DLETO MULTIFUNKCIONALNO

- Ojačana sečiva



MOQ
12

INOX	Br.	Specifikacija	
	16231	20 8 cm	12



TEHNIČKI NOŽ

- Ojačana sečiva

INOX	Br.	Specifikacija	
	16230	21 10 cm	12



FESTA

NOŽ ZA TEPIHE

Br.	Specifikacija	
16225	20 8,5 cm	12



FESTA

ELEKTRIČARSKI NOŽ

- Ojačana sečiva

INOX	Br.	Specifikacija	
	16212	15 3,2 cm	12



FESTA

NOŽ ZA SKIDANJE IZOLACIJE

Br.	Specifikacija	
16201	Ø 8 - 27 mm	10



FESTA

ELEKTRIČARSKI NOŽ

INOX	Br.	Specifikacija	
	16211	20 8,5 cm	10



FESTA

ELEKTRIČARSKI NOŽ

INOX	Br.	Specifikacija	
	16210	20,5 9 cm	10

**FESTA**

NOŽ ZA KALEMLJENJE



INOX	Br.	Specifikacija	24
	16219	19 11 cm	

**FESTA**

NOŽ ZA KALEMLJENJE



INOX	Br.	Specifikacija	24
	16218	18,5 10,5 cm	

**FESTA**

NOŽ ZA KALEMLJENJE



INOX	Br.	Specifikacija	24
	16220	18,5 11 cm	

**FESTA**

PEROREZ



INOX	Br.	Specifikacija	24
	16235	17,5 8,5 cm	

**FESTA**

PEROREZ



INOX	Br.	Specifikacija	24
	16221	21 12 cm	

**FESTA**

PEROREZ



INOX	Br.	Specifikacija	24
	16236	22,5 10 cm	

**FESTA**

PEROREZ



INOX	Br.	Specifikacija	1
	16209	14,5 5,5 cm	

**FESTA**

PEROREZ



INOX	Br.	Specifikacija	24
	16222	20 12 cm	

**FESTA**

PEROREZ



INOX	ALU	Br.	Specifikacija	24
		16223	18,5 10,5 cm	

**FESTA**

PEROREZ

· 5 funkcia

INOX

Br.	Specifikacija
16228	27 10,5 cm



24

**FESTA**

PEROREZ

· 10 funkcia

INOX

Br.	Specifikacija
16226	17,5 7 cm



24



PEROREZ

· 7 funkcia

INOX

Br.	Specifikacija
16224	17,5 7 cm



24



PEROREZ

· 3 funkcia

INOX

Br.	Specifikacija
16227	20,5 10 cm



24

**FESTA**

MULTIFUNKCIONALNE KLIJEŠTA

· 9 funkcia

· Futrola

CrV

Br.	Specifikacija
16232	

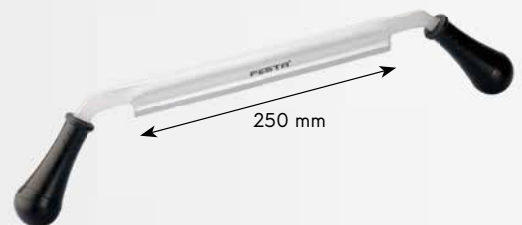

12

NEW**FESTA**

MAKLJA ZA STRUGANJE KORE DRVETA

CrV

Br.	Specifikacija
24132	250/490 mm



1



RUČNI PLANER



Br.	specifikacija
19510	220 x 65 x 130 mm, nůž 48 mm

1



RUČNI PLANER



Br.	specifikacija
19515	200 x 55 x 130 mm, nůž 39 mm

1



RUČNI PLANER



Br.	specifikacija
19520	225 x 27 x 155 mm, nůž 27 mm

1



FESTA

DLETO

CrV

Br.	specifikacija	
19490	6 mm 290 mm	6
19491	8 mm 290 mm	6
19492	10 mm 290 mm	6
19493	12 mm 290 mm	6
19494	14 mm 290 mm	6
19495	16 mm 290 mm	6



FESTA

DLETO

INOX

Br.	specifikacija	
16231	20 80 mm	12



MOQ 12



FESTA

KOMPLET DLETA SA BRUSOM

CrV

5x

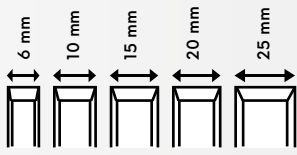

Br.	specifikacija	
19451		10



FESTA

KOMPLET DLETA

CrV

4x

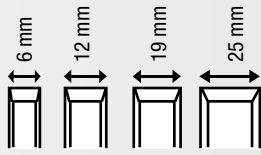

Br.	specifikacija	
19457		10



KOMPLET DLETA

4x

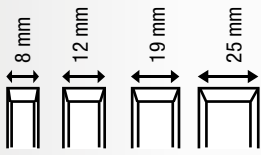

Br.	specifikacija	
19455		30

FESTA



FESTA

KOMPLET DLETA

CrV

8x

Br.	specifikacija	
19458	365 125mm	1



KOMPLET DLETA

4x

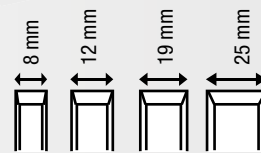

Br.	specifikacija	
19450		20



DLETA ZA REZBARENJE

12x

CrV

Br.	specifikacija	
19459		5

FESTA

NOŽ I DODACI ZA OSTRENJE 16v1



	30° Anvil	
	45° Anvil	
	50° Anvil	
	23° Bypass	
	35° Bypass	
	65° Bypass	
	Deburr Tool	



Br. specifikacija

45073



1



BRUS

Br.	Specifikacija	
45370	250 x 33 x 18 mm	20

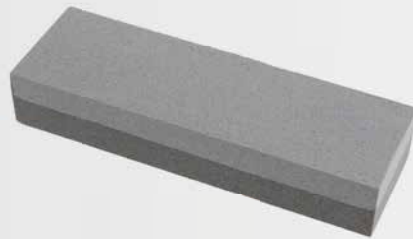

BRUS

Br.	Specifikacija	
45045	150 x 50 x 30 mm	1



BRUS ZA KOSU

Br.	Specifikacija	
45046	205 x 15 mm	100



BRUS ZA NOŽEVE I MAKAZE

Br.	Specifikacija	
16991		20



BRUS ZA NOŽEVE I MAKAZE

Br.	Specifikacija	
16990	Ø 50 mm	1



BRUS ZA NOŽEVE I MAKAZE

Br.	Specifikacija	
45048		20



BRUS ZA NOŽEVE I MAKAZE 6 V 1

Br.	Specifikacija	
45068		10



FESTA
POWER X TOOLS

**PEGLA ZA SPAJANJE PVC CEVI
SA REGULACIJOM TOPLOTE**

- Napon 230 V / 50 Hz
- Potrošnja energije 750 / 1500 W
- Temperatura 0-300 °C
- Za prečnike Ø 20,25,32,40,50,63 mm
- Težina 1,6 kg



· Sadržaj kompleta: metar, libela, inbus ključ, klešta za cevi, 6 adaptera za lemljenje cevi, metalna kutija

 Br.
17182

1

FESTA
POWER X TOOLS

**PEGLA ZA SPAJANJE PVC CEVI
SA REGULACIJOM TOPLOTE**

- Napon 230 V / 50 Hz
- Potrošnja energije 800 / 1000 W
- Temperatura 0-300 °C
- Za prečnike Ø 16, 20, 25, 32 mm
- Težina 1 kg



· Sadržaj kompleta: 4 adaptera za lemljenje cevi, 4 adaptera za lemljenje cevi, metalna kutija kufr

 Br.
17183

1

FESTA
KLJEŠTA ZA PVC CEVI

 ID max.
42 mm

Br.	Specifikacija	
17027		10
16315	Rezervna oštrica	1

**REZERVNA OŠTRICA
ZA SEKAČ PVC CIJEVI**

· Za 17027

Br.	Specifikacija	
16315		1

FESTA

FESTA
**KLJEŠTA
ZA PVC CEVI**

 ID max.
32 mm

Br.	Specifikacija	
17037		12

**KLJEŠTA
ZA PVC CEVI**

 ID max.
42 mm

Br.	Specifikacija	
17026		6

NEW

FESTA

REZAČ
ZA CEVI

INOX ALU

ALU Cu PVC



Br.	Specifikacija	
16305	Ø 22 mm	10
16306	Ø 15 mm	10
16307	NEW Ø 28 mm	10



NEW

FESTA

REZAČ ZA PVC CEVI

PLASTIC INOX

PVC

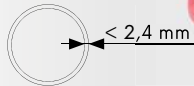

Br.	Specifikacija	
16308	Ø 20 - 50 mm	10

FESTA

REZAČ ZA CEVI

Ø 15 mm
Ø 22 mm
Ø 28 mm

3x INOX ALU

ALU Cu PVC



Br.	Specifikacija	
16309		1



FESTA

REZAČ ZA CEVI



 3-22
mm

Br.	Specifikacija	
16301		10
16311	Rezervni kotačić	1

FESTA

REZAČ ZA CEVI



 6-64
mm

Br.	Specifikacija	
16304		6
16312	Rezervni kotačić	1

REZAČ ZA CEVI



 3-32
mm



Br.	Specifikacija	
16303		10
16311	Rezervni kotačić	1

REZAČ ZA CEVI

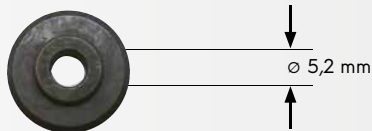

 3-32
mm

Br.	Specifikacija	
16300		10
16310	Rezervni kotačić	1



REZERVNI KOTAČIĆ



Br.	Specifikacija	
16310	∅ 17,5 mm x 6 m za 16300	1
16311	∅ 18,0 mm x 4,5 mm za 16303, 16301	1
16312	∅ 27,5 mm x 6 mm za 16304	1

**FESTA**KLEŠTA
ZA PVC PROFIL

* Letvice, cevi, profili

5x

Br.	Specifikacija	
17050	60 250 mm	

**NEW****FESTA**PLASTICNI
CISTAC IVICA

 6-38
mm

ALU



Br.	Specifikacija	
16319	∅ 6 - 38 mm	1

FESTA

CISTAC IVICA



1/4"

Br.	Specifikacija	
16321		1

PLASTICNI
CISTAC IVICA

 6-32
mm

Br.	Specifikacija	
16320		1

FESTAZAŠILJENI
RUČNI NOŽ
ZA GLODALICU HSS

HSS



Br.	Specifikacija	
20360		10

CISTAC IVICA



Br.	Specifikacija	
20361		1



ODVIJAČ PLJOSNATI

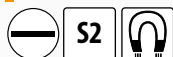

Br.	Specifikacija	
18113	3 x 75 mm	12
18114	4 x 100mm	12
18115	5,5 x 125 mm	12
18116	6,5 x 150 mm	12
18118	8 x 175 mm	6
18120	10 x 200 mm	6



ODVIJAČ PLJOSNATI KRATKI

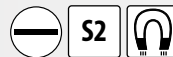

Br.	Specifikacija	
18124	5,5 x 38 mm	12
18125	6,5 x 38 mm	12



ODVIJAČ PHILIPS

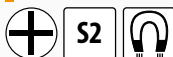

Br.	Specifikacija	
18210	0 x 75 mm	12
18211	1 x 75 mm	12
18212	2 x 100 mm	12



ODVIJAČ PHILIPS KRATKI

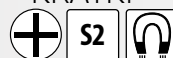

Br.	Specifikacija	
18215	1 x 38 mm	12
18216	2 x 38 mm	12



ODVIJAČ POZIDRIVE

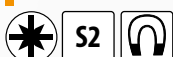

Br.	Specifikacija	
18310	0 x 75 mm	12
18311	1 x 100 mm	12
18312	2 x 100 mm	12
18313	3 x 150 mm	6



ODVIJAČ POZIDRIVE KRATKI

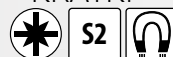

Br.	Specifikacija	
18321	1 x 38 mm	12
18322	2 x 38 mm	12



ODVIJAČ TORX

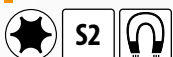

Br.	Specifikacija	
18350	T6	12
18351	T7	12
18352	T8	12
18353	T9	12
18354	T10	12
18355	T15	12
18356	T20	12
18357	T25	12
18358	T27	12
18359	T30	12
18360	T40	6



ODVIJAČ KOMPLET 7 UMETKA



Br.	Specifikacija	
18425		10

- ⊖ S 5 · 6 mm
- ⊕ PH 1 · 2 · 3
- ⊛ T 15 · 20

NEW



KOMPLET ODVIJAČA I BITOVA

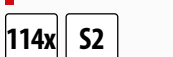

Br.	Specifikacija	
18434		1

- odvijač sa nastavkom za bitove
- odvijač sa nastavkom za fini bitove
- odvijač
 - ⊖ 3x75, 5x75, 5x100, 6x100, 6x150, 8x150
 - ⊕ 0x75, 1x75, 1x100, 2x100, 2x150
 - ⊛ T10x75, T15x75
 - ⊖ VDE 2.5x75mm, 4.0x100mm
 - ⊖ ispitivač napona
 - ⊖ 2.5x40, 3.0x40mm
 - ⊕ 00x40mm, 0x40mm,
 - ⊛ T6x40mm, T7x40mm
- odvijač inbus
 - 1/16", 5/64", 3/32", 1/8", 5/32", 3/16", 7/32", 1/4"
 - 1.5, 2.0, 2.5, 3.0, 4.0, 5.0, 5.5, 6.0mm
- nastavak gedora
 - 6mm, 7mm, 8mm, 9mm, 10mm, 11mm
- bitove
 - ⊖ SL 3mm, 4mm, 4.5mm, 5mm, 5.5mm, 6mm, 7mm, 8mm
 - ⊕ PH0, PH0, PH1, PH1, PH2, PH2, PH3, PH3
 - ⊛ PZ0, PZ0, PZ1, PZ1, PZ2, PZ2, PZ3, PZ3,
 - ⊛ T6, T8, T10, T15, T20, T25, T27, T30, T35, T40
 - H1.5, H2.5, H3.0, H3.5, H4.0, H4.5, H5.0, H5.5, H6, H8
 - ⊖ S0, S1, S2, S3
- fini bitove
 - ⊖ SL 1.5mm, 2.0mm, 2.5mm, 3.0mm, 4.0mm
 - ⊕ PH000, PH00, PH0, PH1
 - ⊛ T4, T5, T6, T7, T8, T9, T10, T15, T20
 - H0.7, H0.9



ODVIJAČ KOMPLET

⊖ S 3x75 · 5x100 · 6,5x150mm

⊕ PH 0 · 1 · 2 · 3



7x



Br. Specifikacija

18402

6



ODVIJAČ KOMPLET

⊖ S 3x75 · 5x100 · 6x150mm

⊕ PH 0 · 1 · 2



6x



Br. Specifikacija

18403

6



ODVIJAČ KOMPLET

⊖ S 6,5x38 · 5,5x75 · 6,5x100 · 8x150 mm
2,5x50 · 3x50 mm

⊕ PH 2x38 · 1x75 · 2x100 · 3x150 mm
0x50 · 00x50 mm

⊛ T 5x50 · 6x50 · 7x50 · 8x50 · 9x50 · 10x50 mm



18x



Br. Specifikacija

18424

6



ODVIJAČ KOMPLET

⊖ S 3x75 · 5x100 · 6,5x150 mm

⊛ PZ 0 · 1 · 2



6x



Br. Specifikacija

18404

6



ODVIJAČ KOMPLET TORX

⊛ T 10 · 15 · 20 · 25 · 30



5x



Br. Specifikacija

18340

6



KOMPLET ODVIJAČA I BITOVA

⊖ S 3 x 75 · 4x100 · 5,5x125 · 6,5 x 150mm

⊕ PH1 x 100 · 2 x 100mm

⊙ adapter 1/4"

Bity | Битов ⊖ S 4 · 5 · 6 · 7

⊕ PH1 · 2 · 3

⊛ PZ1 · 2 · 3

⊛ T 10 · 15 · 20 · 25 · 30

⊙ H 2 · 3 · 4 · 5 · 6



27x



Br. Specifikacija

18422

27 kom

6



FESTA
INDUSTRY

ELEKTRO VDE ODVIJAČ PLJOSNATI



Br.	Specifikacija		
18088	3 x 75 mm	S2	12
18089	4 x 100 mm	CrV	12
18090	5,5 x 125 mm	CrV	12
18091	6,5 x 150 mm	CrV	12
18092	8 x 175 mm	CrV	12

**FESTA**
INDUSTRY

ELEKTRO VDE ODVIJAČ PHILIPS



Br.	Specifikacija		
18080	PH 0 x 60 mm	S2	12
18081	PH 1 x 80 mm	CrV	12
18082	PH 2 x 100 mm	CrV	12
18083	PH 3 x 150 mm	CrV	12

**FESTA**
INDUSTRYODVIJAČ ELEKTRIČARSKI
KOMPLET

S 4x100 · 5,5x125 mm · ispitivač napona 0 - 250 V

PH 0x60 · 1x80 · 2x100 mm



Br.	Specifikacija	
18413		6

FESTA
INDUSTRY

ELEKTRO VDE ODVIJAČ POZIDRIVE



Br.	Specifikacija		
18084	PZ 0 x 60 mm	S2	12
18085	PZ 1 x 80 mm	CrV	12
18086	PZ 2 x 100 mm	CrV	12
18087	PZ 3 x 150 mm	CrV	12

**FESTA**

ODVIJAČ UDARNI PLJOSNATI



Br.	Specifikacija		
18062	5,5 x 100 mm		12
18063	7 x 125 mm		6
18064	8 x 150 mm		8
18065	10 x 175 mm		6
18066	10 x 200 mm		6
18067	10 x 250 mm		6

**FESTA**ODVIJAČ ELEKTRIČARSKI
KOMPLET

S 4x100 · 5,5x125 · 6,5x150 mm ·

ispitivač napona 0 - 250 V

PH 0x75 · 1x100 · 2x100 mm



Br.	Specifikacija	
18410		40

FESTA

ODVIJAČ UDARNI PHILIPS



Br.	Specifikacija		
18070	PH 1 x 80 mm		8
18071	PH 2 x 100 mm		12
18072	PH 3 x 150 mm		6

**FESTA**

ODVIJAČ UDARNI POZIDRIVE



Br.	Specifikacija		
18075	PZ 1 x 80 mm		12
18076	PZ 2 x 100 mm		12
18077	PZ 3 x 150 mm		6

**FESTA**

ODVIJAČ UDARNI + 4 UMETKA

S 7 x 35 · 8 x 35 · 8 x 70 mm

PH 2 x 35 · 3 x 35 · 3 x 70 mm

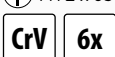

Br.	Specifikacija	
18411		1

**FESTA**

ODVIJAČ UDARNI KOMPLET

S 5 · 6 · 8 mm

PH 1 · 2 · 3



Br.	Specifikacija	
18423		10



**FESTA****KOMPLET ODVIJAČA I BITOVA**

⊖ S 3x75 · 4x75 · 6x100 · 8x150 mm

⊕ PH 1x75 · 2x100 mm

○ Adapter 1/4"

Bity: ⊖ S 4 · 5 · 6 · 7 mm

⊕ PH 1 · 2 · 3

⊗ PZ 1 · 2 · 3

⊛ T 10 · 15 · 20

⊙ ↔ ⊠ adapter



Br.	Specifikacija	
18418		10

**FESTA****ODVIJAČ KOMPLET**

⊖ S 3x60 · 4x75 · 6x100 · 6x125 mm

⊕ PH 0x60 · 1x75 · 2x100 mm



Br.	Specifikacija	
18400		10

**FESTA****ODVIJAČ KOMPLET**

⊖ S 3x60 · 6x100 · 6x125 mm

⊕ PH 1x75 · 2x100 mm



Br.	Specifikacija	
18401		1

FESTA**ODVIJAČ PLJOSNATI**

Br.	Specifikacija	
18101	3 x 75 mm	10
18102	4 x 100 mm	10
18103	5,5 x 100 mm	10
18104	5,5 x 125 mm	10
18105	6,5 x 100 mm	10
18106	6,5 x 125 mm	10
18107	8 x 160 mm	10
18108	10 x 160 mm	10

FESTA**ODVIJAČ PHILIPS**

Br.	Specifikacija	
18201	0 x 75 mm	10
18202	1 x 75 mm	10
18203	2 x 100 mm	10
18204	3 x 150 mm	10

FESTA**ODVIJAČ POZIDRIVE**

Br.	Specifikacija	
18301	0 x 75 mm	10
18302	1 x 75 mm	10
18303	2 x 100 mm	10
18304	3 x 150 mm	10

FESTA**ODVIJAČ SA NASTAVKOM ZA BITOVE**

Br.	Specifikacija	
18110		12

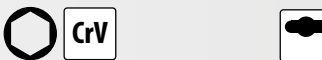
**FESTA****ODVIJAČ SA UDUBLJENJEM**

Br.	Specifikacija	
18455	6 mm	12
18456	7 mm	12
18460	13 mm	12

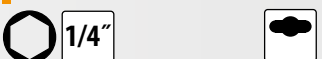
**FESTA****ODVIJAČ FLEKOMIBILNI**

Br.	Specifikacija	
18451		12

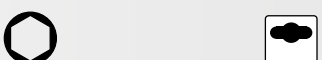
**FESTA****ODVIJAČ FLEKOMIBILNI**

Br.	Specifikacija	
18450	7 mm	6





ODVIJAČ SA NASTAVKOM ZA BITOVE - KRCKALICA

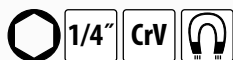

Br. 18433 Specifikacija

6



ODVIJAČ T SA NASTAVKOM ZA BITOVE - KRCKALICA

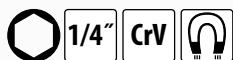

Br. 18608 Specifikacija

6



ODVIJAČ T + 20 NASTAVAKA

- ⊖ S 3 · 4 · 5 · 6 · 8 mm
- ⊕ PH 0 · 1 · 2 · 3
- adapter + 5 · 6 · 7 · 8 · 9 · 10 · 11 · 12 · 13 mm



Br. 18420 Specifikacija

5



KOMPLET FINIH BITOVA SA ADAPTEROM

- ⊖ S 1.5 · 2 · 2.5 · 3 · 3.5 mm
- ⊕ PH 000 · 00 · 0 · 1
- ⊛ PZ 0 · 1
- ⊛ T 5 · 6 · 7 · 8 · 9 · 10 · 15 · 20
- ⊛ H 0.9 · 1.3 · 2.0 · 2.5 · 3.0 · 4.0



Br. 18431 Specifikacija

6



KOMPLET ODVIJAČA I BITOVA

- 1/4" ↔ 1/4"
- ⊖ S 3 · 4 · 5 · 6 · 7 · 5 L
 - ⊕ PH 1 · 2 · 3 · 1L · 2 L
 - ⊛ PZ 1 · 2 · 3 · 1L · 2 L
 - ⊛ H 2 · 2.5 · 3 · 4 · 5 · 6
 - ⊛ T 10 · 15 · 20 · 25 · 27 · 30
 - ⊛ SQ 0 · 1 · 2 · 3
 - 1/4" 5 · 6 · 7 · 8 · 9 · 10 · 11 · 12 · 13 mm



Br. 18419 Specifikacija

6



PRECIZNI ODVIJAČI

- ⊖ S 1,5x50 · 2x50 · 2,5x50 mm
- ⊕ PH 000x50 · 00x50 · 0x50 mm



Br. 18416 Specifikacija

6



PRECIZNI ODVIJAČI

- ⊛ T 4 · 5 · 6 · 7 · 8 · 9 · 10x50 mm



Br. 18417 Specifikacija

6



PRECIZNI ODVIJAČI ELEKTRO

- ⊖ S 2,4 · 3,0 mm
- ⊕ PH 0 · 1
- ⊛ T 6 · 8



Br. 18415 Specifikacija

10

FESTA

NEW

FESTA

ISPITIVAČ NAPONA

· AC - 110 V, 250 V



Br.	Specifikacija
18427	

24

ISPITIVAČ NAPONA

 DIN VDE 0680
73/23 EEC

Br.	Specifikacija
18426	0 - 250 V



ODVIJAČ ČASOVNIČARSKI

S 1,4 · 2,0 · 2,4 · 3,0 mm

PH 0 · 1

6x HOBBY

Br.	Specifikacija
18408	

10

FESTA

OTVARAČ ZA FLAŠE

Br.	Specifikacija
18437	



ADAPTER 90°



Br.	Specifikacija
18910	



KRCKALICA ZA BIT

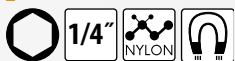

Br.	Specifikacija
18435	93 mm



ODVIJAČ ČASOVNIČARSKI

S 1,0 · 1,2 · 1,4 · 1,8 · 2,4 · 3,0 mm

PH 00 · 0 · 1



11x HOBBY

Br.	Specifikacija
18409	

48

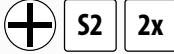

TORSION BIT PH - 50 MM



Br.	specifikacija	
18715	PH1 x 50 mm	1
18716	PH2 x 50 mm	1
18717	PH3 x 50 mm	1



TORSION BIT PZ - 50 MM



Br.	specifikacija	
18710	PZ1 x 50 mm	1
18711	PZ2 x 50 mm	1
18712	PZ3 x 50 mm	1



TORSION BIT T - 50 MM

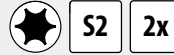

Br.	specifikacija	
18720	T10 x 50 mm	1
18721	T15 x 50 mm	1
18722	T20 x 50 mm	1
18723	T25 x 50 mm	1
18724	T30 x 50 mm	1
18725	T40 x 50 mm	1



TORSION BIT

- PH 2 · 2
- PZ 2
- T 15 · 15 · 20 · 20 · 25 · 30 · 40

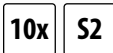

Br.	specifikacija	
18432		1



NEW



Nastavci od najkvalitetnijih materijala CrV S2

Tehnologija proizvodnje

Krstasti i pljosnati nastavci su proizvedeni specijalnom tehnologijom preciznog kovanja koja omogućava postizanje visoke točnosti oblika i ujedno povećane otpornosti i do 20%. Nakon kovanja su nastavci kaljeni tako da dobiju optimalnu tvrdoću i izdržljivost. Kako bi se osiguralo ne klizanje dodatno su pješkareni.

TiN sloj

Dvostruko nanesen sloj na području kontakta sa vijkom maksimalno povećava tvrdoću i habanje, a pješkarenjem se postiglo da ne proklizavaju prilikom korištenja

Dijamantna zrna

Prilikom korištenja se doslovice 'zagrizu' za glavu vijka a drže se i prilikom maksimalnog okreta.

Nerđajući nastavak

Radna površina vrha nastavka izrađena sa velikom zaštitnom protekcijom od klizanja tj. ispadanja iz ležišta gde su postavljeni

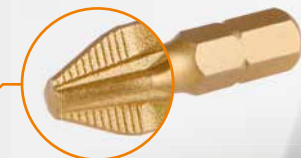



BIT PH

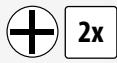

Br.	Specifikacija	
18632A	PH2 x 25 mm	1
18633A	PH3 x 25 mm	1



BIT PZ

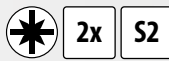

Br.	Specifikacija	
18636A	PZ1 x 25 mm	1
18637A	PZ2 x 25 mm	1
18638A	PZ3 x 25 mm	1



BIT T

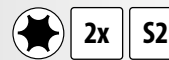

Br.	Specifikacija	
18827A	T20 x 25 mm	1
18828A	T25 x 25 mm	1
18830A	T30 x 25 mm	1
18831A	T40 x 25 mm	1



BIT PH DIJAMANT



Br.	Specifikacija	
18770	PH1 x 25 mm	5
18771	PH2 x 25 mm	5
18772	PH3 x 25 mm	5



BIT PZ DIJAMANT



Br.	Specifikacija	
18775	PZ1 x 25 mm	5
18776	PZ2 x 25 mm	5
18777	PZ3 x 25 mm	5



BIT S



Br.	Specifikacija	
18620	S 3 x 25 mm	5
18621	S 4 x 25 mm	5
18623	S 5 x 25 mm	5
18625	S 6 x 25 mm	5
18627	S 7 x 25 mm	5
18628	S 8 x 25 mm	5



BIT PH



Br.	Specifikacija	
18630	PH0 x 25 mm	5
18631	PH1 x 25 mm	5
18632	PH2 x 25 mm	5
18633	PH3 x 25 mm	5
18634	PH4 x 25 mm	5



BIT PZ



Br.	Specifikacija	
18635	PZ0 x 25 mm	5
18636	PZ1 x 25 mm	5
18637	PZ2 x 25 mm	5
18638	PZ3 x 25 mm	5
18639	PZ4 x 25 mm	5



BIT PH



Br.	Specifikacija	
18685	PH2 x 25 mm	25



BIT PZ



Br.	Specifikacija	
18680	PZ2 x 25 mm	25



BIT PH



Br.	Specifikacija	
18640	PH1 x 70 mm	10
18641	PH2 x 70 mm	10



BIT PZ



Br.	Specifikacija	
18645	PZ1 x 70 mm	10
18646	PZ2 x 70 mm	10



BIT PH

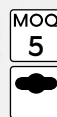
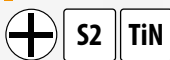

Br.	Specifikacija	
18760	PH0 x 25 mm	5
18761	PH1 x 25 mm	5
18762	PH2 x 25 mm	5
18763	PH3 x 25 mm	5
18764	PH4 x 25 mm	1



BIT PZ

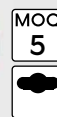
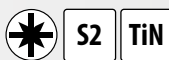

Br.	Specifikacija	
18765	PZ0 x 25 mm	5
18766	PZ1 x 25 mm	5
18767	PZ2 x 25 mm	5
18768	PZ3 x 25 mm	5
18769	PZ4 x 25 mm	5



BIT S



Br.	Specifikacija	
18750	S 3 x 25 mm	5
18751	S 4 x 25 mm	5
18753	S 5 x 25 mm	5
18755	S 6 x 25 mm	5



BIT H



Br.	specifikacija	
18800	H 1,5 x 25 mm	5
18801	H 2,0 x 25 mm	5
18802	H 2,5 x 25 mm	5
18803	H 3,0 x 25 mm	5
18804	H 4,0 x 25 mm	5
18805	H 5,0 x 25 mm	5
18806	H 5,5 x 25 mm	5
18807	H 6,0 x 25 mm	5



BIT TTA



Br.	specifikacija	
18835	TTa 5 x 25 mm	10
18836	TTa 6 x 25 mm	5
18837	TTa 7 x 25 mm	5
18838	TTa 8 x 25 mm	5
18839	TTa 9 x 25 mm	5
18840	TTa 10 x 25 mm	5
18841	TTa 15 x 25 mm	5
18842	TTa 20 x 25 mm	5
18843	TTa 25 x 25 mm	5
18844	TTa 27 x 25 mm	5
18845	TTa 30 x 25 mm	5
18846	TTa 40 x 25 mm	5
18847	TTa 45 x 25 mm	5



BIT T

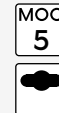

Br.	specifikacija	
18820	T5 x 25 mm	5
18821	T6 x 25 mm	5
18822	T7 x 25 mm	5
18823	T8 x 25 mm	5
18824	T9 x 25 mm	5
18825	T10 x 25 mm	5
18826	T15 x 25 mm	5
18827	T20 x 25 mm	5
18828	T25 x 25 mm	5
18829	T27 x 25 mm	5
18830	T30 x 25 mm	5
18831	T40 x 25 mm	5
18832	T45 x 25 mm	5



BIT HTA



Br.	specifikacija	
18810	HTa 1,5 x 25 mm	5
18811	HTa 2,0 x 25 mm	5
18812	HTa 2,5 x 25 mm	5
18813	HTa 3,0 x 25 mm	5
18814	HTa 4,0 x 25 mm	5
18815	HTa 5,0 x 25 mm	5
18816	HTa 5,5 x 25 mm	5
18817	HTa 6,0 x 25 mm	5



BIT SQ



Br.	specifikacija	
18850	SQ 0 x 25 mm	5
18851	SQ 1 x 25 mm	5
18852	SQ 2 x 25 mm	5
18853	SQ 3 x 25 mm	5



BIT T



Č.p.	specifikacija	
17980	T30 x 35 mm	3
17981	T40 x 35 mm	3
17982	T45 x 35 mm	3
17983	T50 x 35 mm	3



BIT SD



Br.	specifikacija	
18855	SD 6 x 25 mm	5
18856	SD 8 x 25 mm	5



BIT T



Br.	specifikacija	
17970	T20 x 75 mm	3
17971	T25 x 75 mm	3
17972	T30 x 75 mm	3
17973	T40 x 75 mm	3

Br.	specifikacija	
17974	T45 x 75 mm	3
17975	T50 x 75 mm	3
17976	T55 x 75 mm	3



BIT TS



Br.	specifikacija	
18864	TS 4 x 25 mm	5
18865	TS 6 x 25 mm	5



BIT 5/32', 3/16'



Br.	specifikacija	
18866	5/32 x 25 mm	5
18867	3/16 x 25 mm	5



BIT TW

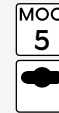

Br.	specifikacija	
18860	TW 1 x 25 mm	5
18861	TW 2 x 25 mm	5
18862	TW 3 x 25 mm	5
18863	TW 4 x 25 mm	5



BIT XZN



Br.	specifikacija	
18870	M4 x 25 mm	5
18871	M5 x 25 mm	5
18872	M6 x 25 mm	5
18873	M8 x 25 mm	5
18874	M10 x 25 mm	5



BIT ADAPTER



Br.	specifikacija	
18868	25 mm	5



BIT ADAPTER



Br.	specifikacija	
18869	50 mm	5



FESTA

BITOVI ZA GIPSANE PLOČE



Br.	specifikacija	MOQ
18795	PH 2 x 25 mm	24



FESTA

BITOVI ZA GIPSANE PLOČE



Br.	specifikacija	MOQ
18796	PH 2 x 55 mm	24



FESTA
INDUSTRY

ADAPTER
KRCKALICA 1/4" - BIT

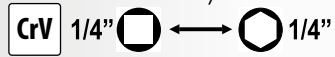

Br.	specifikacija	MOQ
18619	1/4"	5



FESTA
INDUSTRY

NASTAVAK ZA BITOVE



Br.	specifikacija	MOQ
18600	1/4" x 60 mm	5



FESTA
INDUSTRY

NASTAVAK ZA BITOVE

* Quick grip | Цанга за бърза смяна



Br.	specifikacija	MOQ
18601	1/4" x 60 mm	5



FESTA
INDUSTRY

NASTAVAK ZA BITOVE

* Sa graničnikom | Със стопер

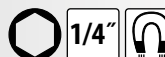

Br.	specifikacija	MOQ
18602	1/4" x 60 mm	5



FESTA
INDUSTRY

NASTAVAK ZA BITOVE



Br.	specifikacija	MOQ
18797	1/4" x 60 mm	1



FESTA
INDUSTRY

NASTAVAK ZA BITOVE

* Quick grip | Цанга за бърза смяна



Br.	specifikacija	MOQ
18798	1/4" x 60 mm	1



FESTA
INDUSTRY

NASTAVAK ZA BITOVE

* Sa graničnikom | Със стопер

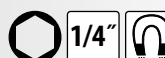

Br.	specifikacija	MOQ
18799	1/4" x 60 mm	1



FESTA
INDUSTRY

NASTAVAK ZA BITOVE



Br.	specifikacija	MOQ
18605	150 mm	25



FESTA

ADAPTER SDS +
ZA BITOVE 1/4"



Br.	specifikacija	MOQ
20743	75 mm	1



NASTAVAK ZA BITOVE



Br.	specifikacija	MOQ
18607	80 mm	25

FESTA

NASTAVAK ZA BITOVE



Br. 18609
specifikacija 90mm



25

NEW

WEST BERG

ADAPTER BIT 1/4" - SDS +

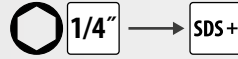

Br. 20742
specifikacija



1

NEW

FESTA INDUSTRY

KOMPLET NASTAVAKA I ADAPTERA

- 10x ⊕ 18630 PH0
- 10x ⊕ 18631 PH1
- 10x ⊕ 18632 PH2
- 10x ⊕ 18633 PH3
- 10x ⊗ 18635 PZ0
- 10x ⊗ 18636 PZ1
- 10x ⊗ 18637 PZ2
- 10x ⊗ 18638 PZ3
- 10x ⊕ 18761 PH1 TiN
- 10x ⊕ 18762 PH2 TiN
- 10x ⊕ 18763 PH3 TiN
- 10x ⊗ 18766 PZ1 TiN
- 10x ⊗ 18767 PZ2 TiN
- 10x ⊗ 18768 PZ3 TiN
- 10x ⊕ 18770 PH1 DIAMANT
- 10x ⊕ 18771 PH2 DIAMANT
- 10x ⊗ 18775 PZ1 DIAMANT
- 10x ⊗ 18776 PZ2 DIAMANT
- 10x ● 18814 4,0HTa
- 10x ● 18815 5,0HTa
- 10x ⊗ 18842 20TTa
- 10x ⊗ 18845 30TTa
- 10x ⊕ 18795 PH2 Za gipsane ploče
- 5x 18612 Adapter 1/4" 8mm
- 5x 18613 Adapter 1/4" 10mm
- 5x 18600 Magnetni nastavak 1/4" 60mm
- 5x 18601 Magnetni nastavak quick grip 1/4" 60mm
- 5x 18602 Magnetni nastavak, sa graničnikom 1/4" 65mm



Br. 18993
specifikacija

1

FESTA INDUSTRY

KOMPLET NASTAVAKA

- 10x ⊕ 18631 PH1
- 10x ⊕ 18632 PH2
- 10x ⊕ 18633 PH3
- 10x ⊗ 18636 PZ1
- 10x ⊗ 18637 PZ2
- 10x ⊗ 18638 PZ3
- 10x ⊕ 18761 PH1 TiN
- 10x ⊕ 18762 PH2 TiN
- 10x ⊕ 18763 PH3 TiN
- 10x ⊗ 18766 PZ1 TiN
- 10x ⊗ 18767 PZ2 TiN
- 10x ⊗ 18768 PZ3 TiN
- 10x ● 18804 H 4
- 10x ● 18805 H 5
- 10x ⊗ 18825 T 10
- 10x ⊗ 18826 T 15
- 10x ⊗ 18827 T 20
- 10x ⊗ 18828 T 25
- 10x ⊗ 18830 T 30
- 10x ⊗ 18831 T 40

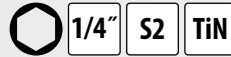

Br. 18994
specifikacija

1

FESTA INDUSTRY

ADAPTER 1/4"

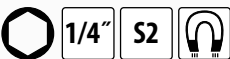

Br.	specifikacija	
18610	6 mm	5
18611	7 mm	5
18612	8 mm	5



Br.	specifikacija	
18613	10 mm	5
18614	12 mm	5
18615	13 mm	5

FESTA INDUSTRY

ADAPTER 1/4"



Br.	specifikacija	
18610A	6 mm	5
18611A	7 mm	5
18612A	8 mm	5



Br.	specifikacija	
18613A	10 mm	5
18614A	12 mm	5
18615A	13 mm	5

FESTA

KOMPLET ADAPTERA



Br. 18618
specifikacija 6, 7, 8, 9, 10, 11, 12, 13 mm



12





FESTA

KOMPLET BITOVA

- bit 25 mm
- ⊖ S 3 · 4 · 5 · 6
 - ⊕ PH 0 · 1 · 2 · 3
 - ⊛ PZ 0 · 1 · 2 · 3
 - H 3 · 4 · 5 · 6
 - ⊛ T 10 · 15 · 20 · 25 · 27 · 30 · 40
 - ⊛ TTa 10 · 15 · 20 · 25 · 27 · 30 · 40

nastavak

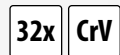

Br.	specifikacija
18908	1



FESTA

KOMPLET BITOVA

- ⊕ S 3 · 4 · 5 · 6
- PH 1 · 2 · 3
- ⊖ PZ 1 · 2 · 3
- H 3 · 4 · 5 · 6
- ⊛ T 10 · 15 · 20 · 25 · 27 · 30 · 40
- ⊛ TTa 10 · 15 · 20 · 25 · 27 · 30 · 40

· Magnetni nastavak quick grip



Br.	specifikacija
18905	10



FESTA

KOMPLET BITOVA

- ⊕ S 4 · 5 · 6
- ⊖ PH 1 · 2 · 3
- ⊛ PZ 1 · 2 · 3
- H 3 · 4 · 5 · 6
- ⊛ T 10 · 15 · 20 · 25 · 27 · 30 · 40
- TTa 10 · 15 · 20 · 25 · 27 · 30 · 40

· Magnetni nastavak quick grip

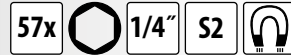

Br.	specifikacija
18906	6

FESTA

KOMPLET BITOVA

- ⊛ HTa 2 · 2.5 · 3 · 4 · 5 · 6
5/32" · 9/64" · 1/8"
7/64" · 3/32" · 5/64"
- SD 4 · 6 · 8 · 10
- ⊛ TS 6 · 8 · 10
- ⊛ TW 1 · 2 · 3 · 4
- ⊛ TTa 8 · 10 · 15 · 20 · 25 · 27 · 30 · 35 · 40

Magnetni nastavak



Br.	specifikacija
18900	10

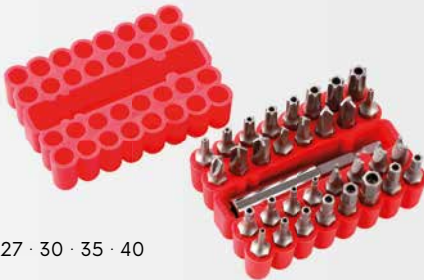

FESTA

KOMPLET BITOVA

- ⊕ S 3 · 4 · 4.5 · 5 · 5.5 · 6 · 6.5 · 7 · 8
- ⊕ PH 0 · 1 · 2 · 3
- ⊛ PZ 0 · 1 · 2 · 3
- ⊖ SQ 0 · 1 · 2 · 3
- ⊛ T 8 · 10 · 15 · 20 · 25 · 27 · 30 · 40 · 45
- ⊛ TTa 8 · 10 · 15 · 20 · 25 · 27 · 30 · 35 · 40
- H 1.5 · 2 · 2.5 · 3 · 4 · 5 · 5.5 · 6 · 8 mm
1/16" · 5/64" · 3/32" · 7/64" · 1/8" · 9/64"
5/32" · 3/16" · 7/32" · 1/4"
- ⊛ HTa 2 · 2.5 · 3 · 4 · 5 · 6 mm
5/64" · 3/32" · 7/64" · 1/8" · 9/64" · 5/32"
- SD 4 · 6 · 8 · 10
- ⊛ TS 6 · 8 · 10
- ⊛ TW 1 · 2 · 3 · 4
- ⊛ 2-wing 1 · 2 · 3
- ⊛ XZN 5 · 6 · 8

Magnetni nastavak

Nastavak „Y”
1/4" DR nastavak za odvijač
1/4" adapter: 25mm, 50mm



Br.	specifikacija
18909	24



FESTA

KOMPLET BITOVA

- ⊖ S 3 · 4 · 5 · 6 · 7
- ⊛ PH 0 · 1 · 2 · 3
- PZ 1 · 2 · 3
- ⊕ H 2 · 2.5 · 3 · 4 · 5 · 6
- ⊛ T 10 · 15 · 20 · 25 · 30 · 40

Magnetni nastavak

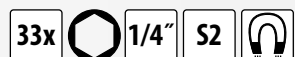

Br.	specifikacija
18901	10



KOMPLET BITOVA

- ⊖ S 4 · 5 · 6 · 7
- ⊕ PH 1 · 2 · 3
- ⊛ PZ 1 · 2 · 3
- H 4 · 5 · 6
- ⊛ T 10 · 15 · 20 · 25
- SQ 1 · 2 · 3

20x **S2**



10x **CrV** **TiN**

Br.	specifikacija	
18907		10



KOMPLET BITOVA

- ⊖ S 4 · 5 · 6 · 7
- ⊕ PH 1 · 2 · 3
- ⊛ PZ 1 · 2 · 3

10x **CrV** **TiN**

Br.	specifikacija	
18440		10



KOMPLET BITOVA

- ⊖ S 3 · 5 · 7
 - ⊕ PH 1 · 2 · 3
- Magnetni nastavak

7x **HOBBY**



Br.	specifikacija	
18430		20



KOMPLET BITOVA

- ⊕ S 3 · 3,5 · 4 · 5,5
- ⊛ PH 0 · 1 · 2 · 3
- ⊖ PZ 0 · 1 · 2 · 3
- H 3 · 4
- ⊛ T 10 · 15 · 20 · 25 · 27 · 30
- 1/4" 4 · 4,5 · 5 · 5,5 · 6 · 7 · 8 · 9 · 10 · 11 · 13

Nastavak za odvijač 1/4"
Magnetni nastavak

CrV **1/4"**

40x



Br.	specifikacija	
18915		10



KOMPLET ALATA

- ⊖ S 5 · 6 mm
- ⊕ PH 1 · 2
- H 3 · 4 · 5 · 6
- ⊛ T 15 · 20 · 25 · 30
- 1/4" 4 · 5 · 6 · 7 · 8 · 9 · 10 · 12 · 13 mm

75 mm 1/4"
 1/4" ↔ 1/4"

1/4" **CrV**

23x



Br.	specifikacija	
18421		10





FESTA

KOMPLET ALATA

122x CrV S2 1/4" 1/2" 72T

- 1/2", 1/4"
- 1/4" · 4-5-6-7-8-9mm
- 1/2" · 10-12-13-14-17-19mm
- 1/4" · 4-4.5-5-5.5-6-7-8-9-10-11-12-13-14mm
- 1/2" · 12-13-14-15-16-17-18-19-20-21-22-24mm
- 1/2", 1/4"
- 1/4" 1/4"
- 1/4" · 150mm
- 1/2" · 254mm
- 1/2", 1/4"
- 1/2" · 16-21mm
- 1/4" · 150mm
- 1/2" · E10-E12-E14-E16-E18-E20-E22-E24
- 1/4" S 3 · 4 · 5 · 6
- 1/4" PH 0 · 1 · 2
- 1/4" PZ 0 · 1 · 2
- 1/4"
- 1/4" · S 4 · 5,5 · 6,5
- 1/4" PH 1 · 2 · 3
- 1/4" PZ 2 · 3
- 1/4" H 3 · 4 · 5 · 6
- 1/4" T 8 · 10 · 15 · 20 · 25
- 1/4" TTa 10 · 15 · 20 · 25 · 40
- 2 · 2,5 · 3 · 4 · 5 · 6 · 7 · 8 · 10mm
- 8-9-10-11-12-13-14-15-16-17-18-19mm
- S 4x100 · 6,5x150
- PH 2x100 · 3x150
- 180mm
- 160mm
- 160mm
- 250mm
- 300g

Br. 17238 specifikacija 122 kom.



1



KOMPLET ALATA

- 160 mm
- 160 mm
- 300 g
- 1/4" 45T
- 4 · 5 · 6 · 7 · 8 · 9 · 10 · 11 · 12 · 13 mm
- 1/4" 75 mm
- 1,5 · 2 · 2,5 · 3 · 4 · 5 · 6 · 8 · 10 mm
- S 3 · 4 · 5 · 6 mm
- PH 0 · 1 · 2 · 3
- PZ 0 · 1 · 2 · 3
- T 10 · 15 · 20 · 25
- H 3 · 4 · 5 · 6
- S 5x100 mm
- PH 1x100 · 2x100 mm
- S 2,5x50 mm
- PH 00x50 · 0x50 mm
- AC 100-250 V
- 200 mm max. 22 mm
- 10x11 · 12x13 · 14x15 · 16x17 mm
- 18 mm
- 2 m 13 mm

60x



35x

Br. 17259 specifikacija

5



KOMPLET ALATA

- 120mm
- 125mm
- 115mm
- 150mm max. 19mm
- 9mm
- 1/4" 160mm
- 5 · 6 · 7 · 8 · 9 · 10 · 11 mm
- 1/4"
- 1/4"
- S 4 · 6 mm
- PH 1 · 2 · 3
- PZ 1 · 2
- H 4 · 5 · 6

Br. 17260 specifikacija



39x

10



KOMPLET ALATA

- 1/4" 5 · 6 · 7 · 8 · 9 · 10 · 11 · 12 mm
- 1/4"
- 1/4"
- AC 230 V
- PH 0, SL 3
- 9x 1,5-10 mm
- 160 mm
- S 3 · 4 · 5 · 6 mm
- PH 0 · 1 · 2 · 3
- H 4 · 5
- PH 2x100, S 6x100
- 18 mm
- 1 m
- 300 g

Br. 17247 specifikacija



10

FESTA

10 years
guarantee



Cr-Mo

- For use in industry and services
- High quality Chrom Vanadium steel
- Ratchet with 72 teeth for the most precise work
- All components by DIN norm
- Knurled heads for better grip
- Strong case with steel lockers and steel hinges



FESTA

GEDORA KOMPLET

- 1/2", 1/4", 3/8"
- 1/4" · 4-5-6-7-8-9-10mm
- 3/8" · 10-11-12-13-14-15mm
- 1/2" · 16-17-18-19-22mm
- 1/4" · 4-4.5-5-5.5-6-7-8-9-10-11-12-13-14mm
- 3/8" · 10-11-12-13-14-15-16-17-18-19mm
- 1/2" · 10-11-12-13-14-15-16-17-18-19-20-21-22-24-27-30-32mm
- 1/4" · E4-E5-E6-E7-E8
- 3/8" · E10-E11-E12-E14-E16-E18
- 1/2" · E20-E24
- 1/2" · 24x
- 1/4" · 20x
- 1/4" · 30x
- 1/4" · 50 mm, 100 mm
- 1/2" · 125 mm, 250 mm
- 3/8" · 150 mm
- 1/2" · 16-21mm
- 3/8" · 18mm
- 1/2", 1/4", 3/8" bit holder
- 1/2", 1/4", 3/8"
- 1/4" · 150mm
- 1/4" · 115mm
- Inbus 7X



10 years
guarantee



CrV S2 1/4" 1/2" 3/8" 72T 171x ERGO HANDLE

Br. 17237 Specifikacija 2



FESTA

GEDORA KOMPLET

- 1/2" · 72T
- 1/2" · 125 mm
- 1/2" · 10-11-12-13-14-15-17-19-22-24 mm

10 years guarantee

CrV 1/2" 72T 12x ERGO HANDLE

Č.p. specifikace 17245 15



FESTA

GEDORA KOMPLET

- 1/2" · 72T
- 1/2" · 125 mm
- 1/2" · 10-11-12-13-14-15-17-19-22-24 mm

10 years guarantee

CrV 1/2" 72T 12x ERGO HANDLE

Č.p. specifikace 17229 8



FESTA

GEDORA KOMPLET

- 1/2" · 72 T
- 1/2" · 75, 125 mm
- 1/2"
- 1/2" · 10-11-12-13-14-15-16-17-18-19-22-24 mm
- 1/2" · 17mm, 19mm
- 3 way adapter
- 16mm, 21mm

10 years guarantee

CrV 1/2" 72T 20x ERGO HANDLE

Č.p. specifikace 17230 4



FESTA

GEDORA KOMPLET

- 1/4" · 72 T
- 1/4" · 50, 100 mm
- 1/4"
- 1/4" · 4-5-5,5-6-7-8-10-11-12-13 mm
- 1/4" · 6-7-8-10-12-13 mm
- 3 way adapter
- 4 x
- 11x
- 1x

10 years guarantee

CrV S2 1/4" 72T 36x ERGO HANDLE

Č.p. specifikace 17231 10



FESTA

GEDORA KOMPLET

- 1/4"
- 1/4"
- 1/4" · 4-4,5-5-5,5-6-7-8-9-10-11-12-13-14 mm
- 1/4" · 50 mm, 100 mm
- 1/4"
- 1/4"
- 21 x
- 1/4"
- L 1/4"

10 years guarantee

CrV S2 1/4" 72T 45x ERGO HANDLE

Č.p. specifikace 17233 10



FESTA

GEDORA KOMPLET

- 1/2", 1/4" · 72T
- 1/4"
- 16 mm, 21 mm
- 1/4" · 10-11-12-13-14-15-16-17-18-19-20-21-22-23-24-27 mm
- 1/4" · 100 mm
- 1/2" · 125 mm, 250 mm
- 1/4"
- 1x
- 1/4" · 4-5-5,5-6-7-8-10-11-12-13 mm
- 33 x











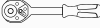
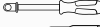



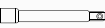

10 years guarantee

CrV S2 1/4" 1/2" 72T 73x ERGO HANDLE

Č.p. specifikace 17234 4

FESTA

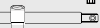
GEDORA KOMPLET

-  1/2", 1/4" · 72T
-  1/4"
-  16 mm, 21 mm
-  1/4" · 4 -4,5-5-5,5-6-7-8-9-10-11-12-13-14 mm
-  1/2" · 10-11-12-13-14-15-16-17-18-19-20-21-22-23-24-27-30-32 mm
-  1/4" · 6-7-8-9-10-11-12-13 mm
-  1/2" · 14-15-17-19 mm
-  1/4" · 50 mm, 100 mm
-  1/2" · 125 mm, 250 mm
-  1/4"
-  5/16" bit holder
-  17x
-  15x
-  3 way adapter
-  3 x
-  1/4"
-  L 1/4"
-  1/2", 1/4"

CrV S2 1/4" 1/2" 72T 94x ERGO HANDLE











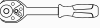
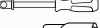







10 years guarantee

Č.p.	specifikace
17235	4

FESTA

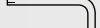
GEDORA KOMPLET

-  1/2", 1/4" · 72T
-  150 mm
-  16 mm, 21 mm
-  1/4" · 4 -4,5-5-5,5-6-7-8-9-10-11-12-13-14 mm
-  1/2" · 10-11-12-13-14-15-16-17-18-19-20-21-22-24-27-30-32 mm
-  1/4" · 6-7-8-9-10-11-12-13 mm
-  1/2" · 14-15-17-19-22 mm
-  1/4" · 50 mm, 100 mm
-  1/2" · 125 mm, 250 mm
-  E · 4-5-6-7-8-10-11-12-14-16-18-20-24-27-30-32 mm
-  1/2", 1/4"
-  5/16" bit holder
-  18 x
-  17 x
-  3 way adapter
-  4 x
-  1/4"
-  L 1/4"

CrV S2 1/4" 1/2" 72T 110x ERGO HANDLE

























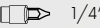
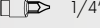
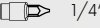
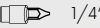
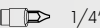

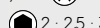
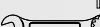
10 years guarantee

Č.p.	specifikace
17236	4

FESTA

KOMPLET ALATA

-  1/2", 1/4"
-  1/4" · 4-5-6-7-8-9mm
-  1/2" · 10-12-13-14-17-19mm
-  1/4" · 4-4,5-5-5,5-6-7-8-9-10-11-12-13-14mm
-  1/2" · 12-13-14-15-16-17-18-19-20-21-22-24mm
-  1/2", 1/4"
-  1/4" · 150mm
-  1/4" · 150mm
-  1/2", 1/4"
-  1/2" · 16-21mm
-  1/4" · 150mm
-  1/2" · E10-E12-E14-E16-E18-E20-E22-E24
-  1/4" · S 3 · 4 · 5 · 6
-  1/4" · PH 0 · 1 · 2
-  1/4" · PZ 0 · 1 · 2
-  1/4" · S 4 · 5,5 · 6,5
-  1/4" · PH 1 · 2 · 3
-  1/4" · PZ 2 · 3
-  1/4" · H 3 · 4 · 5 · 6
-  1/4" · T 8 · 10 · 15 · 20 · 25
-  1/4" · TTα 10 · 15 · 20 · 25 · 40
-  2 · 2,5 · 3 · 4 · 5 · 6 · 7 · 8 · 10mm
-  8-9-10-11-12-13-14-15-16-17-18-19mm
-  S 4x100 · 6,5x150
-  PH 2x100 · 3x150
-  180mm
-  160mm
-  160mm
-  250mm
-  300g

CrV S2 1/4" 1/2" 72T 122x ERGO HANDLE



Č.p.	specifikace
17238	122 ks 1



FESTA



FESTA



RATCHET FESTA

- Ratchet is made from the best quality ChromVanadium steel
- Ratchet with 72 teeth for most precise work
- Quality ergonomic, two-component handle made of softened TPE rubber
- SYSTEM QUICK RELEASE for quick and easy changing of socket heads



FESTA

PROFI KRCKALICA CRV



Č.p.	specifikace	délka	
17297	1/4"	155 mm	6
17298	3/8"	210 mm	5
17299	1/2"	255 mm	4

FESTA

PROFI KRCKALICA CRV



Č.p.	specifikace	délka	
17240	1/4"	155 mm	10
17241	3/8"	200 mm	10
17242	1/2"	250 mm	5

FESTA

PROFI KRCKALICA CRV



Č.p.	specifikace	délka	
17294	1/4"	155 mm	6
17295	3/8"	205 mm	10
17296	1/2"	255 mm	4

FESTA

KRCKALICA 1/4"



Č.p.	specifikace	
17292	1/4"	1

KRCKALICA

HOBBY



Č.p.	specifikace	
17243	1/4" 43T	25
17244	1/2" 39T	25

FESTA

NASTAVAK ZA GEDORE

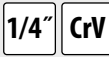

Č.p.	specifikace	
18603	1/4" 150 mm	10

**FESTA****NASTAVAK GEDORA 1/4"**

Č.p.	specifikace	
17820	4 mm • 25 mm	10
17821	4,5 mm • 25 mm	10
17822	5 mm • 25 mm	10
17823	5,5 mm • 25 mm	10
17824	6 mm • 25 mm	10
17825	7 mm • 25 mm	10
17826	8 mm • 25 mm	10
17827	9 mm • 25 mm	10
17828	10 mm • 25 mm	10
17829	11 mm • 25 mm	10
17830	12 mm • 25 mm	10
17831	13 mm • 25 mm	10
17832	14 mm • 25 mm	10

**FESTA****NASTAVAK GEDORA 1/2"**

Č.p.	specifikace	
17308	8 mm • 38 mm	10
17309	9 mm • 38 mm	10
17310	10 mm • 38 mm	10
17311	11 mm • 38 mm	10
17312	12 mm • 38 mm	10
17313	13 mm • 38 mm	10
17314	14 mm • 38 mm	10
17315	15 mm • 38 mm	10
17316	16 mm • 38 mm	10
17317	17 mm • 38 mm	10
17318	18 mm • 38 mm	10
17319	19 mm • 38 mm	10
17320	20 mm • 38 mm	10
17321	21 mm • 38 mm	10
17322	22 mm • 38 mm	10
17324	24 mm • 38 mm	10
17327	27 mm • 42 mm	20
17330	30 mm • 42 mm	25
17332	32 mm • 42 mm	20
17333	34 mm • 42 mm	20
17334	36 mm • 42 mm	20

**FESTA****NASTAVAK GEDORA 3/4"**

Č.p.	specifikace	
17835	17 mm • 48 mm	10
17836	18 mm • 48 mm	10
17837	19 mm • 48 mm	10
17838	21 mm • 48 mm	10
17839	22 mm • 48 mm	10
17840	24 mm • 48 mm	10
17841	26 mm • 48 mm	10
17842	27 mm • 52 mm	10
17843	28 mm • 52 mm	10
17844	30 mm • 52 mm	10
17845	32 mm • 52 mm	10
17846	33 mm • 55 mm	10
17847	36 mm • 60 mm	10
17848	38 mm • 60 mm	10
17849	41 mm • 65 mm	10
17850	46 mm • 65 mm	10
17851	50 mm • 70 mm	10
17852	55 mm • 75 mm	10
17853	60 mm • 78 mm	10
17854	65 mm • 82 mm	10
17855	70 mm • 82 mm	10
17856	75 mm • 88 mm	10

**FESTA****NASTAVAK GEDORA MULTILOCK 1/2"**

Č.p.	specifikace	
17910	8 mm • 38 mm	10
17914	12 mm • 38 mm	10
17916	14 mm • 38 mm	10
17922	21 mm • 38 mm	10
17924	24 mm • 38 mm	10
17926	30 mm • 38 mm	10

**FESTA****NASTAVAK GEDORA 1/4"**

Č.p.	specifikace	
17860	4 mm • 50 mm	10
17861	5 mm • 50 mm	10
17862	6 mm • 50 mm	10
17863	7 mm • 50 mm	10
17864	8 mm • 50 mm	10
17865	9 mm • 50 mm	10
17866	10 mm • 50 mm	10
17867	11 mm • 50 mm	10
17868	12 mm • 50 mm	10
17869	13 mm • 50 mm	10
17870	14 mm • 50 mm	10

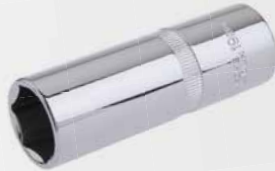
**FESTA****NASTAVAK GEDORA 1/2"**

Č.p.	specifikace	
17871	10 mm • 70 mm	10
17872	11 mm • 70 mm	10
17873	12 mm • 70 mm	10
17874	13 mm • 70 mm	10
17875	14 mm • 70 mm	10
17876	15 mm • 70 mm	10
17877	16 mm • 70 mm	10
17878	17 mm • 70 mm	10
17879	18 mm • 70 mm	10
17880	19 mm • 70 mm	10
17881	20 mm • 70 mm	10
17882	21 mm • 70 mm	10
17883	22 mm • 70 mm	10
17884	23 mm • 70 mm	10
17885	24 mm • 70 mm	10
17886	25 mm • 70 mm	10
17887	26 mm • 70 mm	10
17888	27 mm • 70 mm	10
17889	28 mm • 70 mm	10
17890	30 mm • 70 mm	10
17891	32 mm • 70 mm	10
17892	34 mm • 70 mm	10

**FESTA****NASTAVAK GEDORA TORX 1/2"**

Č.p.	specifikace	
17943	E22	10
17944	E24	10

**FESTA****NASTAVAK GEDORA TORX 1/4"**

Č.p.	specifikace	
17930	E4	10
17934	E8	10
17935	E10	10

**FESTA****NASTAVAK GEDORA MULTILOCK 1/4"**

Č.p.	specifikace	
17895	4 mm • 25 mm	10
17896	4,5 mm • 25 mm	10
17897	5 mm • 25 mm	10
17898	5,5 mm • 25 mm	10
17904	11 mm • 25 mm	10
17905	12 mm • 25 mm	10
17907	14 mm • 25 mm	10





FESTA

NASTAVAK GEDORA 1/4"

CrV S2 1/4"

Č.p.	specifikace	
18920	S 4 mm	10
18921	S 5,5 mm	10
18922	S 7 mm	10



FESTA

NASTAVAK GEDORA 1/4"

CrV S2 1/4"

Č.p.	specifikace	
18925	PH 1	10
18926	PH 2	10
18927	PH 3	10



FESTA

NASTAVAK GEDORA 1/4"

CrV S2 1/4"

Č.p.	specifikace	
18928	PZ 0	10
18929	PZ 1	10
18930	PZ 2	10
18931	PZ 3	10



FESTA

NASTAVAK GEDORA 1/2"

CrV S2 1/2"

Č.p.	specifikace	
18954	T 10	10
18955	T 15	10
18956	T 20	10
18960	T 40	10
18961	T 45	10
18963	T 55	10



FESTA

NASTAVAK GEDORA 1/4"

CrV S2 1/4"

Č.p.	specifikace	
18948	T 5	10
18950	T 8	10
18951	T 10	10



FESTA

NASTAVAK GEDORA 1/4"

CrV S2 1/4"

Č.p.	specifikace	
18934	3 mm	10
18939	8 mm	10



FESTA

NASTAVAK GEDORA 1/2"

CrV S2 1/2"

Č.p.	specifikace	
18971	M 16	10



FESTA

KLIZEČÍ NASTAVAK ZA GEDORU

CrV

Č.p.	specifikace	
17420	1/4"	1
17421	1/2"	1
17422	3/4"	1



FESTA

ADAPTER

CrV

Č.p.	specifikace	
17410	A - 1/4" B - 3/8"	10
17411	A - 3/8" B - 1/4"	10
17412	A - 3/8" B - 1/2"	10
17413	A - 1/2" B - 3/8"	10
17414	A - 1/2" B - 3/4"	10
17415	A - 3/4" B - 1/2"	10
17416	A - 1/4" B - 1/2"	10



FESTA

PRODUŽNI NASTAVAK ZA GEDORU

CrV

Č.p.	specifikace	
17390	1/4" • 50 mm	1
17391	1/4" • 100 mm	1
17392	1/4" • 150 mm	1
17393	1/2" • 75 mm	1
17394	1/2" • 125 mm	1
17395	1/2" • 250 mm	1
17396	3/4" • 100 mm	1
17397	3/4" • 200 mm	1
17398	3/4" • 400 mm	1



FESTA

NASTAVAK GEDORE ZGLOBNI

CrV

Č.p.	specifikace	
17405	1/4" • 39 mm	10
17406	1/2" • 71 mm	10
17407	3/4" • 105 mm	10

FESTA

"T" NASTAVAK KLIZEČÍ ZA GEDORU

CrV

Č.p.	specifikace	
17382	1/4" • 115 mm	1
17383	3/8" • 190 mm	1
17384	1/2" • 250 mm	1
17385	3/4" • 460 mm	1
17386	1" • 640 mm	1



FESTA

"T" NASTAVAK ZA GEDORU SA KOLENOM

CrV

Č.p.	specifikace	
17401	1/4" • 250 mm	1
17402	1/2" • 400 mm	1





FESTA

OKRETNA RUČKA ZA GEDORU

CrV

Br.	Specifikacija	1
17380	1/2" • 350 mm	1
17381	3/4" • 500 mm	1



FESTA

L RUČICA ZA GEDORU

CrV 1/2"

Br.	Specifikacija	1
17427	1/2" • 60 x 320 mm	1



FESTA

FLEKOMIBILNI NASTAVAK ZA GEDORU

CrV 1/4"

Br.	Specifikacija	1
17400	1/4" • 150 mm	1

Stahlberg

ADAPTER KRCKALICA 1/4" - BIT

CrV

1/4" ↔ 1/4"

Br.	Specifikacija	5
18619		5



MOQ 5

NASTAVAK GEDORA UNIVERZALNI

CrV 1/2"

Br.	Specifikacija	1
17812	10 - 19 mm	1



NASTAVAK GEDORA UNIVERZALNI

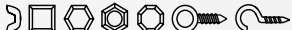

CrV 3/8"

Br.	Specifikacija	1
17810	Za vijke 7 - 19 mm • 52 mm x ø26 mm	1



1/4"

3/8"

NASTAVAK GEDORA UNIVERZALNI

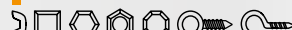

CrV 1/2"

Br.	Specifikacija	5
17811	Za vijke 11 - 32 mm • 83 mm x ø43 mm	5



1/4"

1/2"

NASTAVAK GEDORA DRIVELOCK

4-5-5.5-6-7-8-9-10-11-12-13 mm

CrV 1/4" 12x

Č.p.	specifikace	10
17250		10



NASTAVAK GEDORA TORX

1/4" • 5-6-7-8-10
1/2" • 12-14-16-18

CrV 1/2" 1/4" 9x

Č.p.	specifikace	4
17255		4



KOMPLET ADAPTERA ZA BUŠILICU

CrV 1/4" 3x

Br.	Specifikacija	10
18604	1/4", 3/8", 1/2"	10



FESTA

UNIVERZALNI KLJUČ ZA RADIJATORE

CrV 1/2"

Br.	Specifikacija	10
17455		10

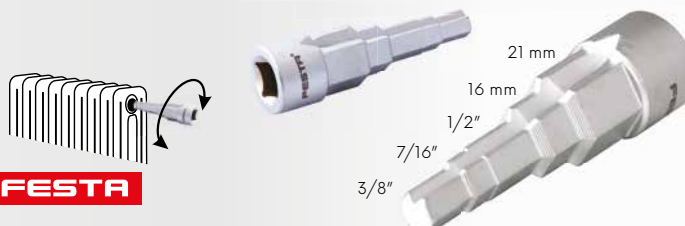

NEW



FESTA

KOMPLET T KLJUČEVA - INBUS + TORX

- H 2.5 · 3 · 4 · 5 · 6 · 8 · 10 mm
- ★ T 10 · 15 · 20 · 25 · 30 · 40 · 45

14x CrV



Br.	specifikacija	
18501		1

FESTA

KOMPLET T KLJUČEVA INBUS

- 2 mm
- 2,5 mm
- 3 mm
- 4 mm
- 5 mm
- 6 mm
- 7 mm
- 8 mm
- 10 mm

9x CrV



Br.	specifikacija	
18494		6



FESTA

T KLJUČ TORX

CrV



Br.	specifikacija		Br.	specifikacija	
17350	T 7	10	17357	T 27	10
17351	T 8	10	17359	T 40	10
17352	T 9	10	17361	T 50	10
17353	T 10	10			

FESTA

KOMPLET T KLJUČEVA TORX

- T 10
- T 15
- T 20
- T 25
- T 27
- T 30
- T 40
- T 45
- T 50

9x CrV



Br.	specifikacija	
18495		6



FESTA

ODVIJAČ INBUS

DIN 911 CrV



Č.p.	specifikace	
18567	27 mm 100 x 250 mm	1
18572	32 mm 125 x 315 mm	1

FESTA

ODVIJAČ INBUS PRODUŽENI

CrV



Č.p.	specifikace	
18510	1,5 mm 14 x 74 mm	1
18511	2 mm 16 x 81 mm	1
18512	2,5 mm 18 x 88 mm	1
18513	3 mm 23 x 108 mm	1
18514	4 mm 24 x 107 mm	1
18515	5 mm 23 x 118 mm	1
18516	6 mm 32 x 135 mm	1
18518	8 mm 36 x 153 mm	1
18519	9 mm 38 x 155 mm	1
18520	10 mm 40 x 168 mm	1
18521	11 mm 40 x 230 mm	1
18522	12 mm 45 x 237 mm	1
18523	13 mm 45 x 260 mm	1
18524	14 mm 55 x 265 mm	1
18527	17 mm 60 x 298 mm	1

FESTA

ODVIJAČ INBUS PRODUŽENI SA KUGLICOM

CrV



Č.p.	specifikace	
18575	1,5 mm 15 x 75 mm	1
18576	2 mm 17 x 81 mm	1
18577	2,5 mm 18 x 87 mm	1
18578	3 mm 20 x 96 mm	1
18579	4 mm 24 x 107 mm	1
18580	5 mm 30 x 120 mm	1
18581	6 mm 33 x 136 mm	1
18582	7 mm 34 x 144 mm	1
18583	8 mm 36 x 153 mm	1
18584	9 mm 38 x 155 mm	1
18585	10 mm 40 x 168 mm	1
18587	12 mm 45 x 237 mm	1
18588	13 mm 45 x 210 mm	1
18589	14 mm 55 x 265 mm	1
18593	17 mm 60 x 298 mm	1

FESTA

ODVIJAČ TORX

CrV



Č.p.	specifikace	
18476	T45	1

FESTA

ODVIJAČ INBUS KOMPLET

- H 1,5 mm
- H 2 mm
- H 2,5 mm
- H 3 mm
- H 4 mm
- H 5 mm
- H 6 mm
- H 8 mm
- H 10 mm



9x CrV

Br. specifikacija
18496

5

FESTA

ODVIJAČ INBUS KOMPLET SA KUGLICOM

- H 1,5 mm
- H 2 mm
- H 2,5 mm
- H 3 mm
- H 4 mm
- H 5 mm
- H 6 mm
- H 8 mm
- H 10 mm



9x CrV

Br. specifikacija
18500

5

FESTA

ODVIJAČ INBUS PRODUŽENI KOMPLET

- H 1,5 mm
- H 2 mm
- H 2,5 mm
- H 3 mm
- H 4 mm
- H 5 mm
- H 6 mm
- H 8 mm
- H 10 mm



9x CrV

Br. specifikacija
18490

5

FESTA

ODVIJAČ INBUS KOMPLET SA KUGLICOM

- H 1,5 mm
- H 2 mm
- H 2,5 mm
- H 3 mm
- H 4 mm
- H 5 mm
- H 6 mm
- H 8 mm
- H 10 mm



9x CrV

Br. specifikacija
18498

5

FESTA

ODVIJAČ INBUS KOMPLET SA KUGLICOM

- 1/16"
- 5/64"
- 3/32"
- 1/8"
- 5/32"
- 3/16"
- 1/4"
- 5/16"
- 3/8"



9x CrV

Br. specifikacija
18493

6

FESTA

ODVIJAČ TORX KOMPLET

- T 10 mm
- T 15 mm
- T 20 mm
- T 25 mm
- T 27 mm
- T 30 mm
- T 40 mm
- T 45 mm
- T 50 mm



9x CrV

Br. specifikacija
18497

5

FESTA

ODVIJAČ INBUS PRODUŽENI KOMPLET SA KUGLICOM

- H 1,5 mm
- H 2 mm
- H 2,5 mm
- H 3 mm
- H 4 mm
- H 5 mm
- H 6 mm
- H 8 mm
- H 10 mm



9x CrV

Br. specifikacija
18492

10

FESTA

ODVIJAČ TORX PRODUŽENI KOMPLET

- T 10 mm
- T 15 mm
- T 20 mm
- T 25 mm
- T 27 mm
- T 30 mm
- T 40 mm
- T 45 mm
- T 50 mm

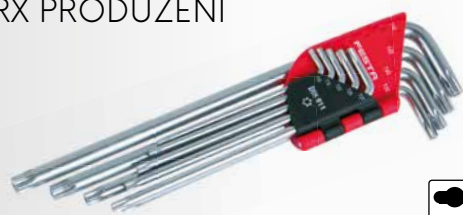

9x CrV

Br. specifikacija
18491

5

FESTA

ODVIJAČ INBUS KOMPLET

CrV



R. s. leírás
18508 1,5 · 2 · 2,5 · 3 · 4 · 5 · 6 mm

1

ODVIJAČ INBUS KOMPLET

HOBBY

8x



Br. specifikacija
18499 2 · 2,5 · 3 · 4 · 5 · 6 · 8 · 10 mm

1

FESTA

KLJUČEVI
VILJUŠKASTI

CrV DIN 3110



Br.	Specifikacija	
17550	6 x 7 mm	10
17551	8 x 9 mm	10
17552	8 x 10 mm	10
17553	10 x 11 mm	10
17590	10 x 13 mm	10
17554	12 x 13 mm	10
17555	14 x 15 mm	10
17556	13 x 16 mm	10
17557	13 x 17 mm	10
17591	14 x 17 mm	10
17558	16 x 17 mm	10
17559	17 x 19 mm	10
17560	18 x 19 mm	10

Br.	Specifikacija	
17592	19 x 22 mm	10
17593	19 x 24 mm	10
17561	20 x 22 mm	10
17569	21 x 23 mm	10
17548	22 x 24 mm	10
17562	24 x 27 mm	10
17549	24 x 30 mm	10
17563	30 x 32 mm	10
17564	30 x 34 mm	10
17565	32 x 36 mm	10
17566	36 x 41 mm	10
17567	46 x 50 mm	10
17568	50 x 55 mm	3

FESTA

KLJUČEVI
VILJUŠKASTI

CrV DIN 3113



Br.	Specifikacija	
17487	6 mm	10
17570	7 mm	10
17571	8 mm	10
17572	9 mm	10
17573	10 mm	10
17574	11 mm	10
17575	12 mm	10
17576	13 mm	10
17577	14 mm	10
17578	15 mm	10
17579	16 mm	10
17580	17 mm	10
17581	18 mm	10
17582	19 mm	10
17488	20 mm	10

Br.	Specifikacija	
17489	21 mm	10
17583	22 mm	10
17490	23 mm	10
17584	24 mm	10
17491	25 mm	10
17492	26 mm	10
17585	27 mm	10
17493	28 mm	10
17494	29 mm	10
17586	30 mm	10
17587	32 mm	10
17495	33 mm	10
17496	34 mm	10
17589	36 mm	10

FESTA

KLJUČEVI SA GEDOROM
ZGLOBNI

CrV 72T



Br.	Specifikacija	
17628	8 mm	10
17622	10 mm	10
17623	13 mm	10
17624	14 mm	10
17629	15 mm	10
17630	16 mm	5

Br.	Specifikacija	
17625	17 mm	10
17631	18 mm	10
17626	19 mm	10
17632	21 mm	5
17633	22 mm	5

FESTA

KLJUČEVI
SA GEDOROM

CrV 72T



Br.	Specifikacija	
17660	6 mm	10
17676	7 mm	10
17661	8 mm	10
17662	9 mm	10
17663	10 mm	10
17664	11 mm	10
17665	12 mm	10
17666	13 mm	10
17667	14 mm	10
17668	15 mm	10

Br.	Specifikacija	
17669	16 mm	10
17670	17 mm	10
17671	18 mm	10
17672	19 mm	10
17674	21 mm	5
17675	22 mm	5
17677	24 mm	5
17678	27 mm	5
17679	30 mm	5
17683	32 mm	5

FESTA

KLJUČEVI
VILJUŠKASTI

DIN 895



Br.	Specifikacija	
17460	6 x 7 mm	10
17461	8 x 9 mm	10
17462	8 x 10 mm	10
17463	10 x 11 mm	10
17481	10 x 13 mm	10
17464	12 x 13 mm	10
17465	14 x 15 mm	10
17467	13 x 17 mm	10
17482	14 x 17 mm	10
17468	16 x 17 mm	10

Br.	Specifikacija	
17469	17 x 19 mm	10
17470	18 x 19 mm	10
17483	19 x 22 mm	10
17484	19 x 24 mm	10
17471	20 x 22 mm	10
17472	24 x 27 mm	10
17486	21 x 23 mm	10
17480	28 x 30 mm	10
17473	30 x 32 mm	10
17485	36 x 41 mm	10

FESTA

KLJUČEVI
OKASTI

CrV DIN 838



Br.	Specifikacija	
17605	6 x 7 mm	10
17606	8 x 9 mm	10
17607	8 x 10 mm	10
17608	10 x 11 mm	10
17609	12 x 13 mm	10
17611	13 x 16 mm	10
17612	13 x 17 mm	10

Br.	Specifikacija	
17610	14 x 15 mm	10
17613	16 x 17 mm	10
17614	18 x 19 mm	10
17615	20 x 22 mm	10
17616	24 x 27 mm	10
17617	30 x 32 mm	10

FESTA

KLJUČEVI
VILJUŠKASTI

CrV DIN 3110



Br.	Specifikacija	
17761	14 x 15 mm	10
17769	20 x 22 mm	10

FESTA

KLJUČEVI
VILJUŠKASTI

CrV DIN 3113



Br.	Specifikacija	
17788	14 mm	10
17795	21 mm	10
17806	33 mm	10

FESTA**KLJUČEVI SA GEDOROM
KOMPLET**

8-9-10-11-12-13-14-15-16-17-18-19 mm

CrV**72T**

Br. 17619

Specifikacija

1

FESTA**KLJUČ****Cr-Mo**

12-13-14-15 mm



16-17-18-19 mm

Br. 17685

Specifikacija

12-13-14-15-16-17-18-19 mm

1

FESTA**ŠTELUJUĆI KLJUČ****CrV****ŠTELUJUĆI KLJUČ**

Br.	rozsah	délka	
17197	0 - 29 mm	200 mm	1
17198	0 - 33 mm	250 mm	1
17199	0 - 38 mm	300 mm	1

Br.	rozsah	délka	
17200	0 - 24 mm	200 mm	6
17201	0 - 30 mm	250 mm	6
17202	0 - 34 mm	300 mm	6

FESTA**FESTA****KLJUČEVI VILJUŠKASTI
KOMPLET****CrV****DIN 3110**

Br.	Specifikacija	
17506	6 kom · 6 x 7, 8 x 9, 10 x 11, 12 x 13, 14 x 15, 16 x 17	1
17508	8 kom · 6 x 7, 8 x 9, 10 x 11, 12 x 13, 14 x 15, 16 x 17, 18 x 19, 20 x 22	1

FESTA**KLJUČEVI KOMBINOVANI
KOMPLET****CrV****DIN 3113**

Br.	Specifikacija	
17526	6 kom · 10 x 10, 11 x 11, 13 x 13, 14 x 14, 16 x 16, 17 x 17	1
17528	8 kom · 8 x 8, 10 x 10, 11 x 11, 13 x 13, 14 x 14, 16 x 16, 17 x 17, 19 x 19	1

FESTA**KLJUČEVI OKASTI
KOMPLET****8x****CrV****DIN 838**

Br.	Specifikacija	
17539	6 x 7, 8 x 9, 10 x 11, 12 x 13, 14 x 15, 16 x 17, 18 x 19, 20 x 22	1

FESTA

KLJUČEVI KOMBINOVANI KOMPLET

CrV

DIN 3113



Br.	Specifikacija	
17532	12 kom · 8 x 8, 9 x 9, 10 x 10, 11 x 11, 13 x 13, 14 x 14, 16 x 16, 17 x 17, 18 x 18, 19 x 19, 21 x 21, 22 x 22	10
17533	18 kom · 6 x 6, 7 x 7, 8 x 8, 9 x 9, 10 x 10, 11 x 11, 12 x 12, 13 x 13, 14 x 14, 15 x 15, 16 x 16, 17 x 17, 18 x 18, 19 x 19, 20 x 20, 21 x 21, 22 x 22, 24 x 24	1
17534	25 kom · 6 x 6, 7 x 7, 8 x 8, 9 x 9, 10 x 10, 11 x 11, 12 x 12, 13 x 13, 14 x 14, 15 x 15, 16 x 16, 17 x 17, 18 x 18, 19 x 19, 20 x 20, 21 x 21, 22 x 22, 23 x 23, 24 x 24, 25 x 25, 26 x 26, 27 x 27, 28 x 28, 30 x 30, 32 x 32	4

FESTA

KLJUČEVI VILJUŠKASTI KOMPLET

CrV

DIN 3110

12x



Br.	Specifikacija	
17512	6 x 7, 8 x 9, 10 x 11, 12 x 13, 14 x 15, 16 x 17, 18 x 19, 20 x 22, 21 x 23, 24 x 27, 25 x 28, 30 x 32	1

FESTA

KLJUČEVI VILJUŠKASTI KOMPLET

DIN 895



Br.	Specifikacija	
17475	8 kom · 6 x 7, 8 x 9, 10 x 11, 12 x 13, 14 x 15, 16 x 17, 18 x 19, 20 x 22	5
17476	12 kom · 6 x 7, 8 x 9, 10 x 11, 12 x 13, 14 x 15, 16 x 17, 18 x 19, 20 x 22, 21 x 23, 24 x 27, 28 x 30, 30 x 32	3



KLJUČ ZA UGAONE BRUSILICE



Br.	Specifikacija	
20967	200 mm	15

FESTA

KLJUČ SA GEDOROM KOMPLET

CrV

72T

7x



Br.	Specifikacija	
17620	8, 10, 12, 13, 14, 17, 19	5

FESTA

KLJUČ SA GEDOROM ZGLOBNI - KOMPLET

CrV

72T

7x



Br.	Specifikacija	
17621	10, 12, 13, 14, 15, 17, 19	5

FESTA

KLJUČEVI CEVASTI KOMPLET

CrV

7x



Br.	Specifikacija	
17501	6 x 7, 8 x 9, 10 x 11, 12 x 13, 14 x 15, 16 x 17, 18 x 19	20
17640	Ručica za cevasti ključ · 135 mm	50

FESTA

CIJEVASTI KLJUČ

CrV



Br.	Specifikacija		Br.	Specifikacija	
17650	6 x 7 mm	10	17655	16 x 17 mm	10
17651	8 x 9 mm	10	17645	16 x 18 mm	10
17642	8 x 10 mm	10	17653	16 x 21 mm	10
17652	10 x 11 mm	10	17656	18 x 19 mm	10
17643	12 x 13 mm	10	17657	19 x 22 mm	10
17654	14 x 15 mm	10	17659	22 x 24 mm	10
17644	14 x 17 mm	10	17658	24 x 27 mm	10

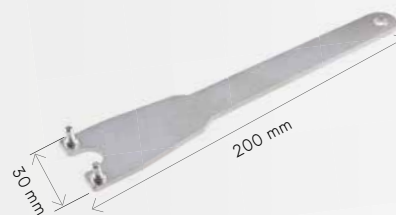

KLJUČ ZA UGAONE BRUSILICE



Br.	Specifikacija	
20968	200 mm	1

FESTAKLJUČ SA
GEDOROM

Br.	Specifikacija	
17452	19 x 22 mm	2

**FESTA**KLJUČ SA
GEDOROM

Br.	Specifikacija	
17451	18 mm	10
17450	19 mm	10

**FESTA**

KILO KLJUČ

Br.	Specifikacija	
17203	1/4" 5 - 25 Nm	1
17204	1/2" 19 - 110 Nm	1
17205	1/2" 42 - 210 Nm	1
17206	3/4" 140 - 700 Nm	1

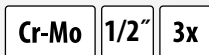
**FESTA**made by **HENITON**NASTAVAK
GEDORA

Č.p.	specifikace	
17338	21 mm	5



KLJUČ ZA TOČKOVE



Br.	Specifikacija	
17600	17, 19, 22 mm, 13/16"	16

KLJUČ ZA TOČKOVE



Br.	Specifikacija	
17601	17, 19, 21 mm	20

TELESKOP
KLJUČ ZA
TOČKOVE

Br.	Specifikacija	
17603	17 x 19 mm, 21 x 23 mm	20

CEVASTI KLJUČ T
ZGLOBNI
SA NASTAVKOM

Br.	Specifikacija	
17261	16 mm	1
17262	21 mm	1

FESTA

KLJUČ KUKA

CrV



Br.	Specifikacija		
17680	19 - 51 mm	165 mm	5
17681	32 - 76 mm	216 mm	5
17682	51 - 121 mm	267 mm	5

IZVLAKAČ –
RADAPCIGER
DVOGLAVI



Br.	mak. prečnika	depth	
23734	Ø 100 mm	50-95 mm	1
23735	Ø 150 mm	100-150 mm	1
23736	Ø 200 mm	110-190 mm	1

IZVLAKAČ –
RADAPCIGER
TROGLAVI



Br.	mak. prečnika	depth	
23730	Ø 100 mm	50-95 mm	2
23731	Ø 150 mm	100-150 mm	2
23732	Ø 200 mm	110-190 mm	2

FESTA

UNIVERZALNI KLJUČ ZA RADIJATORE

CrV 1/2"

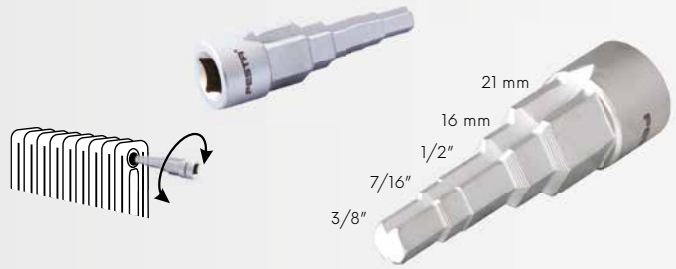

Br.	Specifikacija	
17455		10



KLJUČ ZA ODZRAČIVANJE
RADIJATORA

2x



Br.	Specifikacija	
17454	5 x 5 mm	1

KLJUČ ZA ODZRAČIVANJE RADIJATORA
SA KONTEJNEROM



Br.	Specifikacija	
17459	50 ml	1



FESTA

UNIVERZALNI KLJUČ
ZA RAZVODNE ORMARE

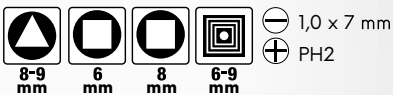

Br.	Specifikacija	
17458		1

FESTA

UNIVERZALNI KLJUČ
ZA RAZVODNE ORMARE

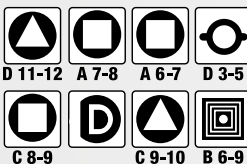

Br.	Specifikacija	
17456		50





KLJEŠTA KOMBINOVANA

DIN 5746	TUV GS	Br.	Specifikacija	
CrV	HRC 58-62	17101	160 mm	6
		17102	180 mm	6
		17103	200 mm	6



KLJEŠTA SEČICE

DIN 5749	TUV GS	CrV	HRC 58-62	ERGONOMIC HANDLE	Br.	Specifikacija	
					17148	180 mm	6



KLJEŠTA SEČICE

DIN 5749	TUV GS	CrV	HRC 58-62	ERGONOMIC HANDLE	Br.	Specifikacija	
					17104	160 mm	6
					17105	180 mm	6



KLJEŠTA ŠPICASTA

DIN 5745	TUV GS	CrV	HRC 58-62	ERGONOMIC HANDLE	Br.	Specifikacija	
					17140	160 mm	6
					17142	200 mm	6



KLJEŠTA ŠPICASTA SAVIJENA

DIN 5749	TUV GS	CrV	HRC 58-62	ERGONOMIC HANDLE	Br.	Specifikacija	
					17145	160 mm	6
					17146	200 mm	6



FESTA



**FESTA**

KLJEŠTA KOMBINOVANA

DIN 5746				
Br.	Specifikacija			
17001	160 mm	6		
17002	180 mm	6		
17003	200 mm	6		

**FESTA**

KLJEŠTA SEČICE

DIN 5749				
Br.	Specifikacija			
17004	160 mm	6		
17005	180 mm	6		

**FESTA**

KLJEŠTA SEČICE

DIN 5749				
Br.	Specifikacija			
17108	180 mm	6		

**FESTA**

KLJEŠTA SEČICE

DIN 5748				
Br.	Specifikacija			
17110	160 mm	6		

**FESTA**

KLJEŠTA ŠPICASTA

DIN 5745				
Br.	Specifikacija			
17006	160 mm	6		
17011	200 mm	6		

**FESTA**

KLJEŠTA ŠPICASTA SAVIJENA

DIN 5745				
Br.	Specifikacija			
17007	160 mm	6		
17008	200 mm	6		

**FESTA**

KLJEŠTA RAVNA

DIN 5746				
Br.	Specifikacija			
17009	160 mm	6		

**FESTA**

KLJEŠTA S OKRUGLIM NOSOM

DIN 5745			
Br.	Specifikacija		
17010	160 mm	6	

**FESTA**

KLJEŠTA ZA SKID.IZOLACIJE

DIN 5744			
Br.	Specifikacija		
17024	160 mm	6	



KLJEŠTA KOMBINOVANA

DIN 5746		
Br.	Specifikacija	
17094	160 mm	6
17095	180 mm	6
17096	200 mm	6



KLJEŠTA SEČICE

DIN 5749		
Br.	Specifikacija	
17097	160 mm	6
17098	180 mm	6



KLJEŠTA ŠPICASTA

DIN 5745		
Br.	Specifikacija	
17099	160 mm	6
17100	200 mm	6

FESTA
INDUSTRY

VDE KLJEŠTA KOMBINOVANA

 1000 V
IEC/EN60900:2004

DIN 5746
CrV
HRC 58-62

Br.	Specifikacija	
17125	160 mm	6
17126	180 mm	6
17127	200 mm	6

FESTA
INDUSTRY

VDE KLJEŠTA SEČICE

 1000 V
IEC/EN60900:2004

DIN 5749
CrV
HRC 58-62

Br.	Specifikacija	
17128	160 mm	6

FESTA
INDUSTRY

VDE MAKAZE ZA ŽICU

 1000 V
IEC/EN60900:2004

CrV
HRC 58-62

Br.	Specifikacija	
17130	160 mm	6

FESTA
INDUSTRY

VDE KLJEŠTA ŠPICASTA

 1000 V
IEC/EN60900:2004

DIN 5745
CrV
HRC 58-62

Br.	Specifikacija	
17133	160 mm	6

FESTA
INDUSTRY

VDE KLJEŠTA ŠPICASTA SAVIJENA

 1000 V
IEC/EN60900:2004

DIN 5745
CrV
HRC 58-62

Br.	Specifikacija	
17135	160 mm	6

FESTA
INDUSTRY

VDE KLEŠTA ELEKTRIČARSKA

 1000 V
IEC/EN60900:2004

DIN 5745
CrV
HRC 58-62

Br.	Specifikacija	
17137	160 mm	6

FESTA
INDUSTRY

VDE KLJEŠTA ZA SKIDANJE IZOLACIJE

 1000 V
IEC/EN60900:2004

CrV
DIN 5744

Br.	Specifikacija	
17138	160 mm	6

FESTA
KLEŠTA ZA FINE KABLOVE
max Ø 0,2 - 2,1 mm

CrV

Br.	Specifikacija	
17047	140 mm	10

FESTA
KLEŠTA ZA FINE KABLOVE
· 0,75; 1,0; 1,5; 2,5; 4,0; 6,0mm²
CrV

Br.	Specifikacija	
17087	145 mm	1

FESTA
AUTOMATSKI SKIDAČ IZOLACIJE

 · 0,5 - 6 mm²
· 190 mm

Br.	Specifikacija	
17178		1

AUTOMATSKI SKIDAČ IZOLACIJE

Br.	Specifikacija	
17180	Ø 0,75 - 2,5 mm	12

MAKAZE ZA SKIDANJE IZOLACIJE I SEČENJE

Br.	Specifikacija	
17181	Ø 0,60 - 2,6 mm	10

NEW



FESTA

SKIDAČ IZOLACIJE

· Ø 0,2-4 mm

Br.	Specifikacija	
16205	125 mm	1

FESTA

SKIDAČ IZOLACIJE

AWG	mm ²
10	6,0
12	4,0
14	2,5
16	1,5
18	1,0
20	0,5

· RG6/59 koakomijalni kabl
· niskonaponski kabl Ø 8 - 13 mm

Br.	Specifikacija	
16202	125 mm	10



FESTA
INDUSTRY

KLEŠTA ZA PRESOVANJE BUKSNI

6x	
Br.	Specifikacija
18445	1

NEW

- AWG 22-18/16-14/12-10
· DIN 0,5-1,0/1,5-2,5/4-6mm²
- AWG 20-16/16-14/12-10/8
· DIN 0,5-1,0/1,5-2,5/4-6/10mm²
- AWG 20-18/16-14/12-10
· DIN 0,5-1,0/1,5-2,5/4-6mm²
- AWG 20/18/17/16/14/12
· DIN 0,5/0,75/1,0/1,5/2,5/4,0mm²
- AWG 10/8/6
· DIN 6/10/16mm²



FESTA
INDUSTRY

KLEŠTA ZA PRESOVANJE

Br.	Specifikacija	
16206		1

NEW

- AWG 10-22
· 0,5-0,6mm²
- AWG 10-22
· 0,5-0,6mm²
- AWG 10-22
· 0,5-0,6mm²
- skidanje žice
· AWG 10-24
· 0,2-0,6mm²



FESTA
INDUSTRY

KLEŠTA ZA PRESOVANJE

Br.	Specifikacija	
16208		1

NEW

- 1,5; 2,5; 6,0mm²
- 1,5; 2,5; 6,0mm²
- skidanje žice · 0,75; 1,0; 1,5; 2,5; 4,0; 6,0mm²
- sečenje vijaka · M2,6; M3; M3,5; M4; M5



FESTA

MULTI-FUNKCIONALNE KLIJEŠTA

- 9 funkcija
- Futrola

CrV

Br.	Specifikacija	
16232		12



FESTA

KLIJEŠTA MINI KOMPLET

4x

Br.	Specifikacija	
17040		6



FESTA

KLJEŠTA MINI

Br.	Specifikacija	
17041	110 mm	12



FESTA

KLJEŠTA MINI

Br.	Specifikacija	
17042	110 mm	12



FESTA

KLJEŠTA MINI

Br.	Specifikacija	
17043	100 mm	12



FESTA

KLJEŠTA MINI

Br.	Specifikacija	
17044	120 mm	12



FESTA

KLJEŠTA MINI

Br.	Specifikacija	
17045	120 mm	12



KLJEŠTA ZA ZEGER

Br.	Specifikacija	
17025	sada	10



FESTA

KLJEŠTA ZA ZEGER

Br.	Specifikacija	
17190	180 mm unutrašnja	6
17191	180 mm spoljašnja	6



FESTA

KLJEŠTA ZA ZEGER

Br.	Specifikacija	
17192	180 mm unutrašnja	15
17193	180 mm spoljašnja	15



FESTA**KLEŠTA
MULTIFUNKCIONALNA**

· Za postavljanje ograde

CrV

Br.	Specifikacija
17109	270 mm

**KLJEŠTA JAKOSTEZAJUČA**

Č.p.	Specifikace		
17150	220 mm	1	

**KLJEŠTA JAKOSTEZAJUČA**

Č.p.	Specifikace		
17151	225 mm	1	

**KLJEŠTA JAKOSTEZAJUČA**

Č.p.	specifikace		
17034	220 mm	5	



max. 70mm

FESTA**KLJEŠTA JAKOSTEZAJUČA**

Č.p.	specifikace		
17036	270 mm	5	

**KLJEŠTA JAKOSTEZAJUČA**

Č.p.	specifikace		
17035	220 mm	10	

**FESTA****KLJEŠTA JAKOSTEZAJUČA**

Č.p.	specifikace		
17023	220 mm	6	

FESTA**VODOVODNA KLEŠTA 45°, S****CrV**

Br.	Specifikacija	
17067	1" 330 mm	1
17068	1,5" 420 mm	1
17069	2" 540 mm	1

**FESTA****VODOVODNA KLEŠTA 90°****CrV**

Br.	Specifikacija	
17063	230 mm	6
17064	300 mm	6

FESTA**VODOVODNA KLEŠTA 90°****CrV**

Br.	Specifikacija	
17075	1" 330 mm	1
17076	1,5" 420 mm	1
17077	2" 540 mm	1

**VODOVODNA KLEŠTA 90°****FESTA****VODOVODNA KLEŠTA 90°****CrV**

Br.	Specifikacija	
17070	2,5" 355 mm	12
17071	3" 455 mm	8
17072	3,5" 610 mm	10



Br.	Specifikacija	
17065	260 mm	36
17066	300 mm	36

FESTA

KLJEŠTA PAPAGAJKE



CrV

Br.	Specifikacija	Otvor željusti	1
16500	180 mm	0 - 40 mm	1
16501	250 mm	0 - 52 mm	1
16502	300 mm	0 - 68 mm	1

FESTA

KLJEŠTA PAPAGAJKE



CrV

Br.	Specifikacija	Otvor željusti	6
17059	180 mm	0 - 30 mm	6
17061	250 mm	0 - 30 mm	6
17062	300 mm	0 - 40 mm	6
17080	400 mm	0 - 84 mm	4

FESTA

KLJEŠTA PAPAGAJKE



CrV

Br.	Specifikacija	Otvor željusti	6
17084	250 mm	0 - 30 mm	6

FESTA

KLJEŠTA PAPAGAJKE



CrV

· large range of jaws

Br.	Specifikacija	Otvor željusti	6
17086	250 mm	0 - 50 mm	6

FESTA

KLJEŠTA PAPAGAJKE



CrV

Br.	Specifikacija	Otvor željusti	6
17081	180 mm	0 - 30 mm	6
17014	250 mm	0 - 30 mm	6
17082	300 mm	0 - 50 mm	6

FESTA

KLJEŠTA PAPAGAJKE



CrV

Br.	Specifikacija	Otvor željusti	6
17079	250 mm	0 - 50 mm	6

FESTA

KLJEŠTA PAPAGAJKE



CrV

Br.	Specifikacija	Otvor željusti	6
17012	250 mm	0 - 40 mm	6
17060	300 mm	0 - 50 mm	10

KLJEŠTA PAPAGAJKE



CrV

Br.	Specifikacija	Otvor željusti	6
17013	250 mm	0 - 30 mm	6
17033	300 mm	0 - 50 mm	6

PLASTIČNE ČELJUSTI ZA KLJEŠTA PAPAGAJKE

· Pogodno za 17061, 17079



Br.	Specifikacija	1
17085	1 par	1

FESTA

MAKAZE ZA ŽICU

- Čelična žica
- ACSR kabel
- Avio kablovi

CrV max. Ø 6 mm

Č.p.	specifikace	6
17029	200 mm	6

FESTA

MAKAZE ZA ŽICU

- Čelična žica
- ACSR kabel
- Avio kablovi

CrV max. Ø 12 mm

Č.p.	specifikace	8
17039	24' 610 mm	8

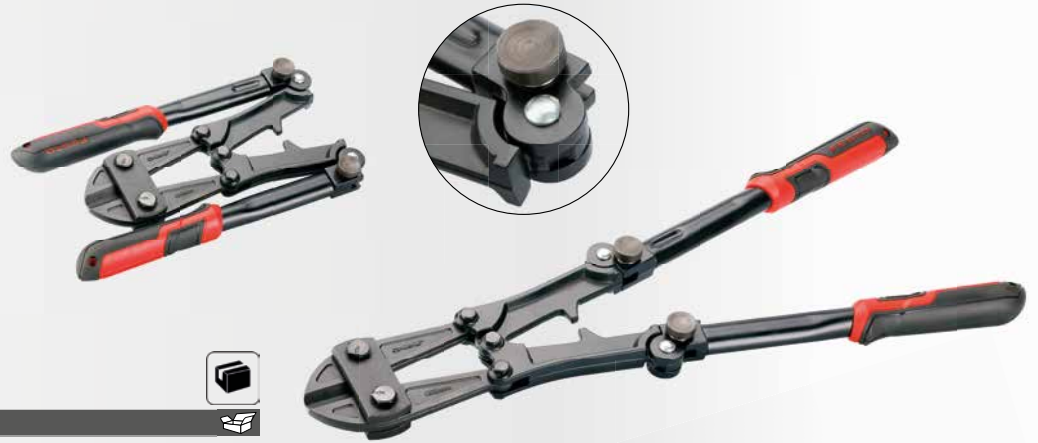
**FESTA**

MAKAZE ZA ARMATURU

Cr-Mo

Br.	Specifikacija		
17049	18' 450 mm	max. 6 mm < 40 HRC	1

FESTA

MAKAZE ZA ARMATURU

Cr-Mo**HRC 58-62**

Br.	Specifikacija	max. Ø drátu	
17051	14' 350 mm	max. 5 mm < 45 HRC	1
17052	18' 450 mm	max. 6 mm < 45 HRC	1
17053	24' 610 mm	max. 8 mm < 45 HRC	1
17054	30' 760 mm	max. 10 mm < 45 HRC	1
17048	36' 900 mm	max. 12 mm < 45 HRC	1

**FESTA**

MAKAZE ZA ARMATURU

· Čeljusti za kablove i žice

Cr-Mo**HRC 58-62**

Br.	Specifikacija	max. Ø drátu	max. Ø lanka	max. Ø kabelu	
17055	14' 360 mm	max. 5 mm < 45 HRC	max. 3,5 mm	max. 8 mm	1
17056	18' 460 mm	max. 6 mm < 45 HRC	max. 5 mm	max. 10 mm	1
17057	24' 610 mm	max. 8 mm < 45 HRC	max. 7 mm	max. 12 mm	1
17058	30' 760 mm	max. 10 mm < 45 HRC	max. 9 mm	max. 14 mm	1
17046	35' 900 mm	max. 12 mm < 45 HRC	max. 10 mm	max. 16 mm	1

**FESTA**

MAKAZE ZA ARMATURU

Cr-Mo**HRC 57-62****max. Ø
4 mm**

Br.	Specifikacija		
17038	8' 210 mm	max. 4 mm < 30 HRC	10

**FESTA**

MAKAZE ZA ARMATURU

- meka žica: Ø 6 mm
- srednje tvrda žica: Ø 5 mm
- tvrda žica: Ø 4 mm

CrV

Br.	Specifikacija		
17078	200 mm		12



MAKAZE ZA ARMATURU



Br.	Specifikacija	max. Ø drátu	
17028	14' 350 mm	max. 5 mm < 30 HRC	30
17020	18' 450 mm	max. 6 mm < 30 HRC	6
17021	24' 610 mm	max. 8 mm < 30 HRC	10
17022	30' 760 mm	max. 10 mm < 30 HRC	5

NEW



FESTA

KLJEŠTA ARMIRAČKA

CrV HRC 58-62

Br.	Specifikacija	
17172	200 mm	1



FESTA

KLJEŠTA STOLARSKA

CrV

Br.	Specifikacija	
17300	160 mm	1
17301	180 mm	10
17302	200 mm	6
17303	250 mm	1



FESTA

KLJEŠTA ARMIRAČKA

CrV

Br.	Specifikacija	
17305	220 mm	5
17306	250 mm	1
17304	275 mm	6



KLJEŠTA STOLARSKA

Br.	Specifikacija	
17015	160 mm	6
17016	180 mm	6
17017	200 mm	6



KLJEŠTA ARMIRAČKA

Br.	Specifikacija	
17019	220 mm	6
17083	275 mm	6



FESTA

KLESTA ZA LIM PRAVA

Br.	Specifikacija	
17089	150 x 215 mm	2

NEW



FESTA

KLESTA ZA LIM PRAVA

Br.	Specifikacija	
17341	24 x 180 mm	1

NEW



FESTA

KLESTA ZA LIM OD 45°

Br.	Specifikacija	
17342	24 x 180 mm	1



FESTA

KLESTA ZA LIM PRAVA

Br.	Specifikacija	
17093	95 x 270 mm	6



FESTA

KLESTA ZA LIM OD 45°

Br.	Specifikacija	
17091	50 x 280 mm	10



FESTA

KLESTA ZA LIM OD 90°

Br.	Specifikacija	
17092	50 x 260 mm	10



FESTA

KLESTA ZA LIM PRAVA

Br.	Specifikacija	
17090	50 x 280 mm	10



FESTA
MAKAZE ZA LIM

Br.	Specifikacija	
17170	50 250 mm	6



MAKAZE ZA LIM

Br.	Specifikacija	
17167	70 300 mm	5



MAKAZE ZA LIM

Br.	Specifikacija	
17165	60 250 mm	5



MAKAZE ZA LIM

Br.	Specifikacija	
17169	35 250 mm	5

FESTA
MAKAZE ZA LIM
PRODUZENI



Cr-Mo HRC 58-62

Br.	Specifikacija	
17113	Prave 80 300 mm	6



FESTA
MAKAZE ZA LIM

Cr-Mo HRC 58-62

Br.	Specifikacija	
17111	Prave 40 250 mm	6
17116	Desne 40 250 mm	6
17121	Leve 40 250 mm	6



FESTA
MAKAZE ZA LIM

Cr-Mo HRC 58-62

Br.	Specifikacija	
17112	Prave 40 260 mm	6
17117	Desne 40 260 mm	6
17122	Leve 40 260 mm	6





ADAPTER ZA SEČENJE PLOČA

Steel	Cu	ALU	
0.8-1 mm	1.5 mm	1.5 mm	
Br.	Specifikacija		
20364			1



MAKAZE ZA LIM

max 0,8 mm

Br.	Specifikacija	
17186	265 mm	6



MAKAZE ZA LIM SA POLUGOM

	17175	17177
Max. 4 mm	5 mm	
	Max. \varnothing 10 mm	\varnothing 12 mm
	Max. 8x8 mm	10x10 mm

ADAPTER ZA SEČENJE PLOČA

- Max. debljina ploče
- 1,8 mm - Čelik
 - 1,2 mm - Nehrđajući
 - 2 mm - Plastika, ALU, bakar



Br.	Specifikacija	
20363		5

Br.	Specifikacija	
17175	150 mm	1
17177	250 mm	1



MAKAZE TEHNIČKE

INOX



Č.p.	specifikace	
16420	60 200 mm	12



TEHNIČKE MAKAZICE

INOX



Č.p.	specifikace	
17159	65 220 mm	12



TEHNIČKE MAKAZICE

INOX



Č.p.	specifikace	
17158	50 150 mm	10



TEHNIČKE MAKAZICE

INOX



Č.p.	specifikace	
17160	70 210 mm	12



MAKAZE

INOX

Č.p.	specifikace	
16405	14 cm	24
16406	17 cm	24
16407	19 cm	24
16408	21,5 cm	12



MAKAZE

3x INOX

Č.p.	specifikace	
16401	3 ks	48



FESTA

MAKAZE ZA BUŠENJE RUPA



Br.	Specifikacija	
17185	Ø 2; 2,5; 3; 3,5; 4; 4,5 mm	12



FESTA

KLEŠTA ZA PVC PROFIL

• Letvice, cevi, profili



Br.	Specifikacija	
17050	60 250 mm ø 17 mm, ø 20 mm, ø 27 mm	8



KLJEŠTA ZA POP NITNE



Br.	specifikacija	
17187	350 mm	6



KLJEŠTA ZA POP NITNE



Br.	specifikacija	
17188	250 mm	12



KLJEŠTA ZA POP NITNE



Br.	specifikacija	
17189	255 mm	12





FESTA

FESTA

KLJEŠTA ZA POP NITNE

Cr-Mo

- Ø 2,4 mm
- Ø 3,2 mm
- Ø 4,0 mm
- Ø 4,8 mm



Br.	specifikacija	
24007	200 mm	1



FESTA

KLJEŠTA ZA POP NITNE

Cr-Mo

- Ø 2,4 mm
- Ø 3,2 mm
- Ø 4,0 mm
- Ø 4,8 mm



Br.	specifikacija	
24010	250 mm	12



FESTA

KLJEŠTA ZA POP NITNE

Cr-Mo

- Ø 2,4 mm
- Ø 3,2 mm
- Ø 4,0 mm
- Ø 4,8 mm
- Ø 6,4 mm



Br.	specifikacija	
24017	280 mm	1



FESTA

KLJEŠTA ZA POP NITNE

Cr-Mo

- Ø 2,4 mm
- Ø 3,2 mm
- Ø 4,0 mm
- Ø 4,8 mm
- Ø 6,4 mm



Br.	specifikacija	
24015	530 mm	1



FESTA

KLJEŠTA ZA POP NITNE

Cr-Mo

- Ø 2,4 mm
- Ø 3,2 mm
- Ø 4,0 mm
- Ø 4,8 mm



Br.	specifikacija	
24030	255 mm	24



FESTA

KLJEŠTA ZA POP NITNE SA OKRENUTOM GLAVOM

Cr-Mo

Br.	specifikacija	
24020	290 mm	8





KLJEŠTA ZA POP NITNE



ALU



Cr-Mo



\varnothing 2,4 x 6 mm
 \varnothing 3,2 x 6 mm
 \varnothing 4,0 x 6 mm
 \varnothing 4,8 x 6 mm



KLJEŠTA ZA POP NITNE



ALU



Br.	specifikacija	
24001	260 mm	6

Br.	specifikacija	
24005	260 mm	5

Br.	specifikacija	
24000	240 mm	24

FESTA

POP NITNE – DODATAK ZA BUŠILICU



\varnothing 2,4 mm
 \varnothing 3,2 mm
 \varnothing 4,0 mm
 \varnothing 4,8 mm



INOX ALU Cu

Cr-Mo



Br.	specifikacija	
24008		1

AL NITNE

ALU

50x



Br.	specifikacija	
23970	3,2 x 6 mm	25
23971	3,2 x 8 mm	25
23972	3,2 x 10 mm	25
23973	3,2 x 12 mm	25
23974	3,2 x 14 mm	25
23975	4,0 x 6 mm	25
23976	4,0 x 8 mm	25
23977	4,0 x 10 mm	25
23978	4,0 x 12 mm	25
23979	4,0 x 14 mm	25
23985	4,8 x 6 mm	25
23986	4,8 x 8 mm	25
23987	4,8 x 10 mm	25
23988	4,8 x 12 mm	25
23989	4,8 x 14 mm	25



FESTA

KLEŠTA ZA POP NITNE PROFI SA MATICAMA

Cr-Mo

· M3
 · M4
 · M5
 · M6
 · M8
 · M10



INOX ALU Cu



Br.	specifikacija	
24036	330 mm	1

FESTA

DELOVI ZA KLEŠTA ZA NITNE

· Pogodan za 24035, 24036

Cr-Mo



Br.	specifikacija	
24038	M3	1
24039	M4	1
24040	M5	1
24041	M6	1
24042	M8	1
24043	M10	1



FESTA

KLEŠTA ZA POP NITNE PROFI SA MATICAMA

Cr-Mo

· M3
 · M4
 · M5
 · M6



INOX ALU Cu



Br.	specifikacija	
24035	200 mm	1

MATICE ZA NITNE,

ALU





20x



Br.	specifikacija	
23950	M3 x 9 mm	20
23951	M4 x 11 mm	20
23952	M5 x 12 mm	50
23953	M6 x 14 mm	50
23954	M8 x 16,5 mm	25
23955	M10 x 18 mm	20

FESTA

HEFTALICA 5 V 1





-  | 6 - 14 mm
23960 - 23964
23760 - 23764,
23906 - 23914
-  | 10 - 14 mm
23965
-  | 15 mm
23966
-  | 15 mm
23967



Br. specifikacija  6

FESTA

HEFTALICA 4 V 1



-  | 6 - 14 mm
23960 - 23964
-  | 12 mm
23965
-  | 14 mm
23966
-  | 14 mm
23967



Br. specifikacija  12

FESTA

HEFTALICA 3 V 1

-  | 6 - 14 mm
23960 - 23964
-  | 14 mm
23966
-  | 14 mm
23967





Br. specifikacija  12



FESTA

HEFTALICA

-  53 | 4 - 14 mm
23904 - 23914,
23760 - 23765

Br. specifikacija  20



HEFTALICA

-  53 | 4 - 14 mm
23760 - 23765,
23904 - 23914

Br. specifikacija  20



HEFTALICA

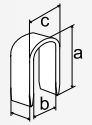

0,7 mm

$\alpha=9-11$ mm, $b=5,5$ mm, $c=6,4$ mm

Br. specifikacija  4



FESTA

HEFTALICA ČEKIĆ

-  | 6 - 10 mm
23960 - 23962

Br. specifikacija  10



HEFTALICA ČEKIĆ

-  | 6 - 10 mm
23960 - 23962

Br. specifikacija  6



FESTA

ODSTRANJIVAČ MUNICIJE

Br. specifikacija  25

FESTA

MUNICIJA ZA HEFTALICU



Br.	specifikacija	
23960	b=6 mm, 1000 kom.	50
23961	b=8 mm, 1000 kom.	50
23962	b=10 mm, 1000 kom.	50
23963	b=12 mm, 1000 kom.	50
23964	b=14 mm, 1000 kom.	50

FESTA

MUNICIJA ZA HEFTALICU

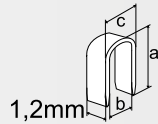

Br.	specifikacija	
23965	a=12 mm, b=6,5 mm, c=7,5 mm, 1000 TW	50

MUNICIJA ZA HEFTALICU (TYP 53)

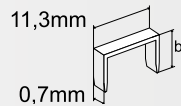

Br.	specifikacija	
23904	b=4 mm 1000 kom.	200
23906	b=6 mm 1000 kom.	200
23908	b=8 mm 1000 kom.	200
23910	b=10 mm 1000 kom.	200
23912	b=12 mm 1000 kom.	200
23914	b=14 mm 1000 kom.	200

**FESTA**

EKOMERI



Br.	specifikacija	
23966	14 mm 1000 TW	100

FESTA

EKOMERI



Br.	specifikacija	
23967	14 mm 1000 TW	100

MUNICIJA ZA HEFTALICU (TYP 53)

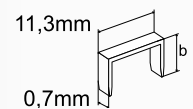
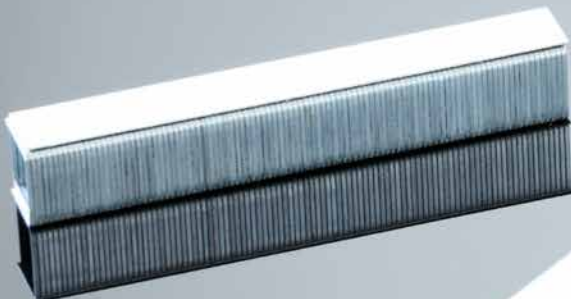
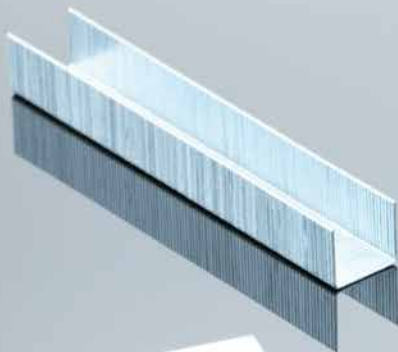

Br.	specifikacija	
23760	b=4 mm 2000 kom.	10
23761	b=6 mm 2000 kom.	10
23762	b=8 mm 2000 kom.	10
23763	b=10 mm 2000 kom.	10
23764	b=12 mm 2000 kom.	10

**FESTA**

FESTA



FESTA

ČETKA ČEL.



Br.	Specifikacija	reda	
22080	270 mm	5 reda	12

FESTA

ČETKA MESING



Br.	Specifikacija	reda	
22082	270 mm	5 reda	12

FESTAČETKE
KOMPLET,
PLASTIČNA
RUČKA

· Nylon, rost-frei, mesing

3x

Br.	Specifikacija	
22086	180 mm	12

ČETKE
KOMPLET,
PLASTIČNA
RUČKA**3x**

Br.	reda	
22081	3 reda	12



22158



22159

ŽIČANA ČETKA

Br.	Specifikacija	Žice	
22158	200 mm	čelik	36
22159	200 mm	mesing	36



22035



22036

ČETKA ČEL. PVC DRŠKA

Br.	Specifikacija	Žice	
22035	270 mm	čelik	24
22036	270 mm	Rost-frei	24



ČETKA ČEL. DRVENA DRŠKA

Br.	Specifikacija	reda	
22033	300 mm	4 reda	12
22034	300 mm	5 reda	12



ČETKA DRVENA DRŠKA

Br.	reda	
22078	3 reda	20



ČETKA DRVENA DRŠKA

Br.	Specifikacija	reda	
22079	300 mm	4 reda	6



FESTA



FESTA

RAVNA TURPIJA



Br.	Specifikacija	asperity	
22206	150 mm	2	10
22180	250 mm	2	10



FESTA

POLUOKRUGLA TURPIJA



Br.	Specifikacija	asperity	
22207	150 mm	2	10
22182	250 mm	2	10



FESTA

ČETVRTASTA TURPIJA



Br.	Specifikacija	asperity	
22184	250 mm	2	10



FESTA

TROUGLASTA TURPIJA



Br.	Specifikacija	asperity	
22183	250 mm	2	10



FESTA

OKRUGLA TURPIJA



Br.	Specifikacija	asperity	
22181	250 mm	2	10



FESTA

TROUGLASTA TURPIJA



Br.	Specifikacija	asperity	
22178	150 mm	1	10

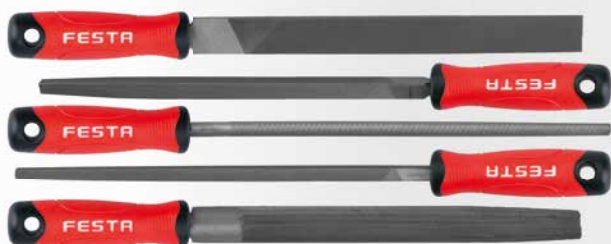

FESTA

KOMPLET TURPIJA



Br.	Specifikacija	asperity	
22209	150 mm	2	10
22186	250 mm	2	5



FESTA

KOMPLET TURPIJA



Br.	Specifikacija	asperity	
22208	150 mm	2	10
22185	250 mm	2	5

FESTA

TURPIJA ZA MOTORNU TESTERU



Br.	Specifikacija		Br.	Specifikacija	
22170	200 mm 3,5 mm	10	22173	200 mm 5 mm	10
22171	200 mm 4 mm	10	22174	200 mm 5,5 mm	10
22172	200 mm 4,5 mm	10			



Ø 4 mm

FESTA

PRIBOR ZA BRUŠENJE LANCA



Br.	Specifikacija	
22190	300 mm	5

**FESTA**

KOMPLET IGLIČASTIH TURPIJA



10x	Br.	Specifikacija	20
	22188		

**FESTA**

KOMPLET DIJAMANTNIH TURPIJA



10x	Br.	Specifikacija	25
	22189		

**FESTA**

TURPIJA RAVNA ZA DRVO

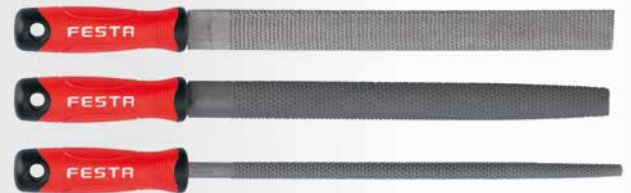

Br.	Specifikacija	
22202	150 mm	10
22197	300 mm	10

**FESTA**

KOMPLET TURPIJA ZA DRVO



3x	Br.	Specifikacija	5
	22196	250 mm	

**FESTA**

TURPIJA POLUOKRUGLA ZA DRVO



Br.	Specifikacija	
22203	150 mm	6
22199	300 mm	6

**FESTA**

TURPIJA OKRUGLA ZA DRVO



Br.	Specifikacija	
22204	150 mm	10
22205	250 mm	10
22198	300 mm	10

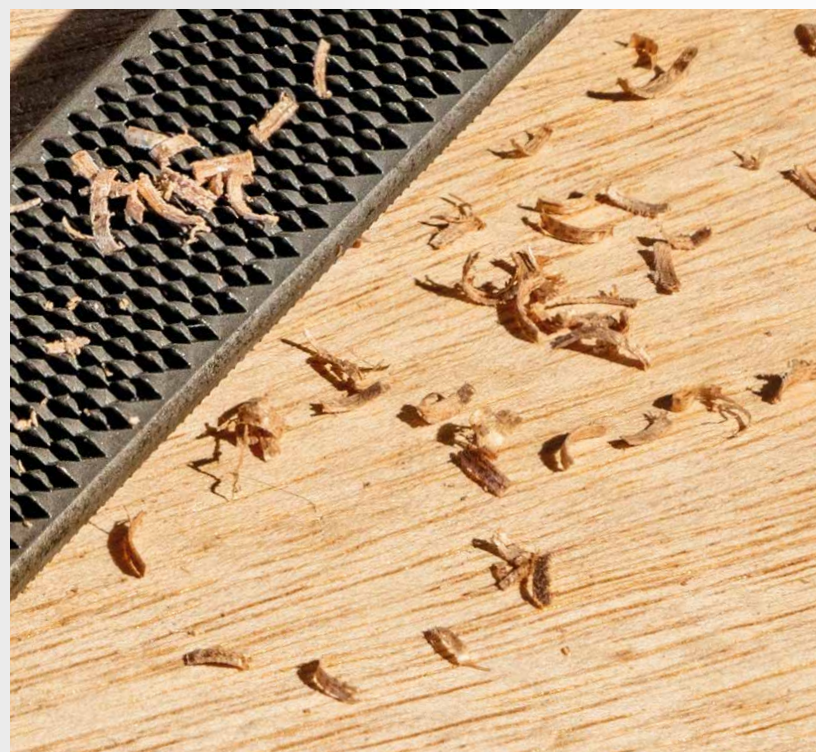

FESTA
BONSEK



Br.	Specifikacija	
24104	300 mm	6

FESTA
BONSEK

· Ojačani ram



Br.	Specifikacija	
24102	300 mm	6

BONSEK

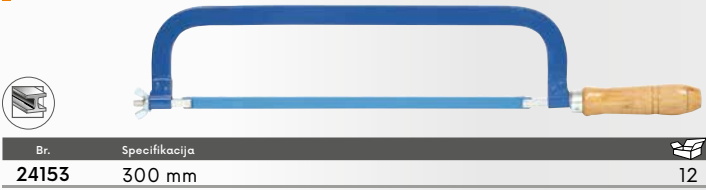

Br.	Specifikacija	
24153	300 mm	12

FESTA
BONSEK



Br.	Specifikacija	
24100	300 mm	12

BONSEK



Br.	Specifikacija	
24170	300 mm	12

FESTA
BONSEK



MADE IN EU
Br. Specifikacija
24126 300 x 25 x 0,65 mm TPI 24 | 14



Br.	Specifikacija	
24126	300 x 25 x 0,65 mm TPI 24 14	10

FESTA
BONSEK

· List testere 24108



Br.	Specifikacija	
24125	150 mm	6

FESTA
BONSEK

· List testere 24109



Br.	Specifikacija	
24124	260 mm	12

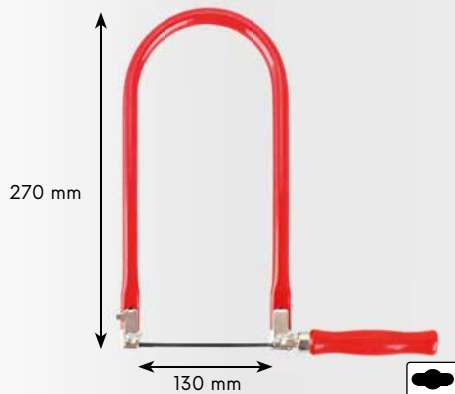

BONSEK

Br.	Specifikacija	
24121	bosnek	12
24110	list testere	30

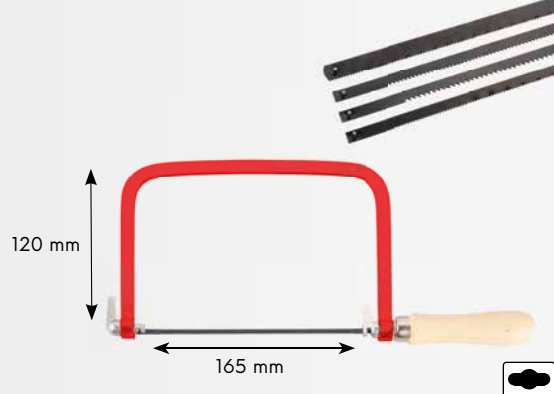

BONSEK

· 5x list testere

Br.	Specifikacija	
24122	bosnek	20
24111	list testere	30

FESTA

RUČNA TESTERA PVC DRŠKA

TEFLON



Trostrano naoštreni zubi, termički ojačani zubi

Br.	Specifikacija	
24143	300 mm	12
24144	400 mm	12
24145	500 mm	12

**FESTA**

TESTERA FUSMANS STOLARSKI

TEFLON



Trostrano naoštreni zubi, termički ojačani zubi

Br.	Specifikacija	
24147	300 mm	6

**FESTA**

TESTERA ŠPICASTA



Trostrano naoštreni zubi, termički ojačani zubi

Br.	Specifikacija	
24149	300 mm	12

**FESTA**

JAPANSKA TESTERA

SK5



Trostrano naoštreni zubi, termički ojačani zubi



Br.	Specifikacija	
24134	250 mm 0,5 mm	10

**FESTA**

JAPANSKA TESTERA

SK5



Trostrano naoštreni zubi, termički ojačani zubi



Br.	Specifikacija	
24115	260 mm 0,6 mm	10

**FESTA**

JAPANSKA TESTERA

SK5



Trostrano naoštreni zubi, termički ojačani zubi



Br.	Specifikacija	
24114	260 mm 0,6 mm	10



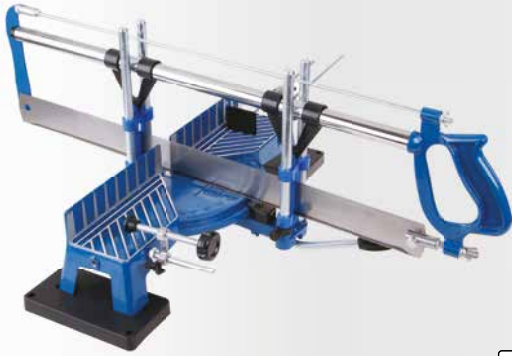

TESTERA UGAONA PROFI



Br.	Specifikacija	
24130	600 mm	1
24131	600 mm, list testere	1



TESTERA UGAONA



Br.	Specifikacija	
24148	300 mm	25

ŠABLON ZA SEČENJE



Br.	Specifikacija	
24171	80 x 300 mm	10

ŠABLON ZA SEČENJE



Br.	Specifikacija	
24133	300 x 140 mm	18

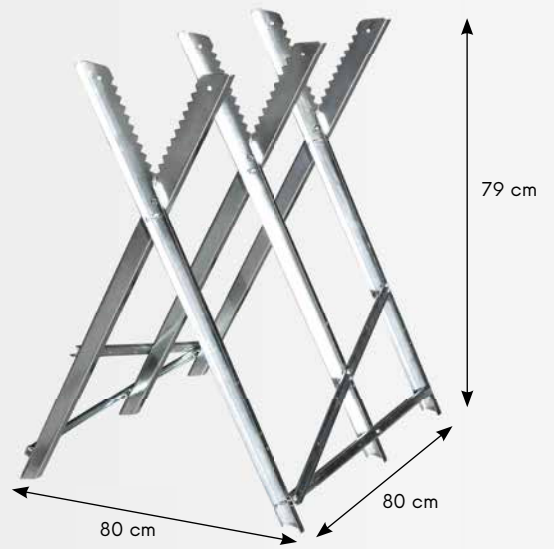

STALAK ZA SEČENJE DRVETA



Br.	Specifikacija	
37570	max. 150 kg	3

FESTA

TESTERA U MET. RAMU

• Termički ojačani zubi



Br.	Specifikacija		Br.	Specifikacija	
24141	450 mm	12	24136	760 mm	12
24140	533 mm	12	24142	800 mm	12
24135	610 mm	12	24137	914 mm	12

FESTA

TESTERA U MET. RAMU

• Termički ojačani zubi



Br.	Specifikacija	
24173	350 mm	24

TESTERA BONSEK



Br.	Specifikacija	
24151	300 mm	10

TESTERA ZA GRANE



Br.	Specifikacija	
24150	300 mm	5

TESTERA

Br.	Specifikacija	
24128	450 mm list 24192	6

**FESTA**

PREKLOPNA TESTERA



· Trostrano naoštreni zubi, termički ojačani zubi



Br.	Specifikacija	
45061	150 mm with cover of handle	12

**FESTA**

TESTERA ZA GRANE PREKLOPNA



· Trostrano naoštreni zubi, termički ojačani zubi



Br.	Specifikacija	
45060	180 mm	6

**FESTA**

TESTERA ZA GRANE



· Trostrano naoštreni zubi, termički ojačani zubi



Br.	Specifikacija	
45062	260 mm with case	24



TESTERA ZA GRANE



· Trostrano naoštreni zubi, termički ojačani zubi

Br.	Specifikacija	
24152	350 mm 6 tpi	12

FESTA

TELESKOPSKA TESTERA



· Trostrano naoštreni zubi, termički ojačani zubi

Br.	Specifikacija	
45033	230 - 490 mm	1

TESTERA
ZA GRANE
SA KANAPOM

Br.	Specifikacija	
45030	pilka 30 cm Teleskopska mjerna šipka 260 cm	6
45031	pilka 30 cm	6

TESTERA ZA GRANE
SA KANAPOM

Br.	Specifikacija	
45032	Metalna bez pile	6

FESTA

TESTERA ZA POLIESTER



Br.	Specifikacija	
24174	380 mm	1

FESTA

TESTERA ZA OPEKE



Br.	Specifikacija	
24181	550 mm	1

FESTA

TESTERA VIDIJUM



Br.	Specifikacija	
24158	22 22 SK zuba - 450 mm	5

FESTA

TESTERA VIDIJUM



• Termički ojačani zubi



Br.	Specifikacija	
24175	bez SK zuba - 600 mm EU	2
24178	bez SK zuba - 600 mm	6

FESTA

TESTERA ZA GIPSANE PLOČE



• Trostrano naoštreni zubi, termički ojačani zubi



Br.	Specifikacija	
24159	150 mm	12

BOSNEK ZA GIP. PLOČE



Br.	Specifikacija	
24190	270 mm	10

FESTA

TESTERA VIDIJUM



Br.	Specifikacija	
24155	34 17 SK zuba - 600 mm	2
24156	34 34 SK zuba - 600 mm	2

FESTA

TESTERA VIDIJUM



Br.	Specifikacija	
24176	34 17 SK zuba - 750 mm	6
24177	34 34 SK zuba - 750 mm	6



**FESTA**

ČEKIĆ

· Drška jasen

DIN
1041

Br.	specifikacija	
19081	100 g	1
19082	200 g	1
19083	300 g	1
19084	400 g	1
19085	500 g	1
19086	600 g	1
19088	800 g	1
19090	1000 g	1
19092	1500 g	1
19095	2000 g	1

**FESTA**

ČEKIĆ

· Drška jasen

DIN
1041

Br.	specifikacija	
19096	3000 g	1
19097	4000 g	1
19098	5000 g	1
19106	6000 g	1
19108	8000 g	1
19109	10000 g	1

**FESTA**

MACOLA

· Drška jasen

DIN
6475

Br.	specifikacija	
19041	1000 g	1
19042	1250 g	1
19043	1500 g	1
19044	2000 g	1

FESTA
MACOLA

· Drška jasen

DIN
6475

Br.	specifikacija	
19045	3000 g	1
19046	4000 g	1
19074	5000 g	1
19075	6000 g	1
19076	8000 g	1
19077	10000 g	1

**FESTA**

ČEKIĆ FIBERGLASS

· Fiberglass

Č.p.	specifikace	
19021	100 g	12
19022	200 g	12
19023	300 g	12
19024	400 g	12
19025	500 g	12
19026	600 g	6
19028	800 g	6
19030	1000 g	6
19031	1500 g	6
19032	2000 g	1

FESTAMACOLA
FIBERGLASS

· Fiberglass

DIN
6475

Č.p.	specifikace	
19066	1000 g	4
19067	1250 g	4
19068	1500 g	4
19069	2000 g	2

FESTA

ČEKIĆ FIBERGLASS

· Fiberglass



Č.p.	specifikace	
19034	3000 g	4
19036	4000 g	4

FESTA

ČEKIĆ FIBERGLASS

· Fiberglass

DIN
6475

Č.p.	specifikace	
19070	3000 g	4
19071	4000 g	4
19058	5000 g	4
19059	6000 g	2

FESTA**ČEKIĆ
TESARSKI
FIBERGLASS**

· Fiberglass



Č.p.	specifikace	
19061	600 g	6

**FESTA****ČEKIĆ
OBUČARSKI
FIBERGLASS**

· Fiberglass

Č.p.	specifikace	
19064	450 g	6

**FESTA****ČEKIĆ
TESARSKI
MONOLIT**

Č.p.	specifikace	
19062	600 g	6

**FESTA****ČEKIĆ
OBUČARSKI
MONOLIT**

Č.p.	specifikace	
19063	450 g	6

**ČEKIĆ
TESARSKI**

Č.p.	specifikace	
19100	600 g	6

**FESTA****ČEKIĆ
MONOLIT**

Č.p.	specifikace	
19150	600 g	6

**FESTA****ČEKIĆ TESARSKI**

Č.p.	specifikace	
19060	600 g	6

**FESTA****ČEKIĆ
OBUČARSKI**

Č.p.	specifikace	
19065	450 g	6

**FESTA****ČEKIĆ
ZIDARSKI
FIBERGLASS**

· Fiberglass

Č.p.	specifikace	
19151	600 g	6

**FESTA****ČEKIĆ ZIDARSKI**

· Drška jasen

Č.p.	specifikace	
19149	44 mm	1

**FESTA****ČEKIĆ ZIDARSKI**

· Drška jasen

Č.p.	specifikace	
19124	24 mm	1
19136	36 mm	1
19148	48 mm	1

**FESTA****ČEKIĆ - SEKIRA**

Č.p.	specifikace	
19303	600 g	6



FESTA**MACOLA**

Č.p.	specifikace	
19051	1000 g	6
19052	1500 g	6

**MACOLA**

· Kružni klin

DIN 6475

Č.p.	specifikace	
19053	1000 g	6
19050	1250 g	6
19054	1500 g	6
19055	2000 g	6

ČEKIČ

· Kružni klin

DIN 1041

Č.p.	specifikace	
19001	100 g	12
19002	200 g	12
19003	300 g	6
19004	400 g	6
19005	500 g	6
19006	600 g	6
19008	800 g	6
19010	1000 g	6
19015	1500 g	6
19020	2000 g	6

MACOLA

· Kružni klin

DIN 6475

Č.p.	specifikace	
19056	3000 g	6
19057	4000 g	6

VARILAČKI ČEKIČ

Č.p.	specifikace	
19115	320 g	1

**FESTA****DRŽALJA ZA ČEKIČE – JASEN**

Br.	specifikacija	
61240	drška	1

**DRŽALJA ZA ČEKIČE JASEN**

Br.	specifikacija	za čekiče	
61320	26 cm	19081	10
61321	28 cm	19082	10
61322	30 cm	19083	10
61323	31 cm	19084	10
61324	32 cm	19085	10



Br.	specifikacija	za čekiče	
61325	33 cm	19086	10
61326	35 cm	19088	10
61327	36 cm	19090	10
61328	38 cm	19092	10
61329	40 cm	19095	10

DRŽALJA ZA MACOLE – JASEN

Br.	specifikacija	za macole	
61330	80 cm	19074, 19075	10
61331	90 cm	19076, 19077	10

**KRUŽNI KLIN**

Br.	specifikacija	
19430	6 mm	10
19431	8 mm	10
19432	10 mm	10
19433	12 mm	10
19434	14 mm	10
19435	16 mm	10

**KAJLICE**

Br.	specifikacija	
19440	Uski	10
19441	Srednji	10
19442	Široki	10
19443	Široki S	10

**FESTA****KAJLICE****3x**

Br.	specifikacija	
19398	20 x 25 x 5 mm	1
19399	30 x 40 x 5 mm	1





FESTA



FESTA

DRVENI ČEKIĆ

• Bukovo drvo



Br.	specifikacija	
19202	Ø 60 x 120 mm	260 g



FESTA

ČEKIĆ GUMENI

• Drška jasen



Br.	specifikacija	
19245	Ø 55 mm	400 g
19246	Ø 60 mm	800 g
19247	Ø 70 mm	1000 g
19248	Ø 95 mm	2000 g
19249	Ø 115 mm	3000 g

FESTA

ČEKIČ GUMENI

· Fiberglass



Br.	specifikacija	
19270	Ø 55 mm	6
19271	Ø 65 mm	6
19272	Ø 90 mm	6

**FESTA**

ČEKIČ GUMENI



Br.	specifikacija	
19255	Ø 55 mm	6
19265	Ø 65 mm	6
19290	Ø 90 mm	6

**FESTA**

ČEKIČ BELA GUMA

· Fiberglass

Br.	specifikacija	
19281	680g	6

**NEW****FESTA**

ČEKIČ BELA GUMA



Br.	specifikacija	
19293	Ø 55 mm	6
19294	Ø 65 mm	6
19295	Ø 90 mm	6

**FESTA**ČEKIČ
MESING

· Fiberglass

Br.	specifikacija	
19211	Ø 30 mm 500 g	1

**FESTA**

ČEKIČ NYLON

· Fiberglass



Br.	specifikacija	
19209	Ø 34 mm	6



ČEKIČ GUMENI



Br.	specifikacija	
19251	Ø 55 mm 400 g	12
19252	Ø 65 mm 700 g	6
19253	Ø 90 mm 1300 g	4



ČEKIČ GUMENI



Br.	specifikacija	
19254	Ø 65 mm	6

ČEKIČ
SILIKONSKI

Br.	specifikacija	
19297	Ø 30 mm	12

**FESTA**

PALIČKA S VÝMĚNNÝMI KONCI

- PP - 97 Shore A ·
- TPU - 95 Shore A ·
- TPE - 90 Shore A ·
- TPE - 90 Shore A ·
- TPU - 92 Shore A ·
- TPU - 92 Shore A ·
- TPU - 88 Shore A ·
- TPE - 90 Shore A ·

Br.	specifikacija	
19208	Ø 38 mm	1

SET ČEKIČA SA NASTAVCIMA ZA AUTO POPRAVKU

7x

Br. 19110 specifikacija



5



FESTA

PAJSER



Br.	specifikacija	Box
19420	300 mm	1



FESTA

PAJSER

Br.	specifikacija	Box
19424	400 mm	6
19425	600 mm	6
19426	800 mm	6
19427	1000 mm	6



PAJSER

Br.	specifikacija	Box
19416	600 mm Ø 16 mm	4
19422	800 mm Ø 16 mm	4
19421	1000 mm Ø 18 mm	4



PAJSER

Br.	specifikacija	Box
19423	380 x 35 x 6 mm	1



FESTA

KUKA ZA EKOMERE

Br.	specifikacija	Box
19415	300 mm Ø 15 mm	6





FESTA

SEKAČ

CrV	Br.	specifikacija	širka hrotu	
	19406	300 mm	25 mm	5
	19407	400 mm	30 mm	5



FESTA

ŠPIC

CrV	Br.	specifikacija	
	19408	250 mm	5
	19409	350 mm	5



FESTA

SEKAČ

CrV	Br.	specifikacija	širka hrotu	
	19460	300 mm	25 mm	5
	19470	400 mm	30 mm	5



ŠPIC

Br.	specifikacija	
19400	250 mm	5
19403	350 mm	6



SEKAČ

Br.	specifikacija	širka hrotu	
19401	250 mm	19 mm	6
19404	350 mm	22 mm	6



SEKAČ

Br.	specifikacija	širka hrotu	
19402	250 mm	50 mm	2
19405	350 mm	50 mm	6



FESTA

KOMPLET SEKAČA I PROBIJAČA

12x CrV

- 2, 6, 8 mm
- 10, 12, 16 mm
- Ø 1,5-3-4-5-6-8 mm

Br.	Specifikacija	
19487		4



FESTA

KOMPLET SEKAČA I PROBIJAČA

6x CrV

- 2 x 140, 8 x 115 mm
- 12 x 152, 10 x 142 mm
- Ø 3 x 152, 6 x 152 mm

Br.	Specifikacija	
19486		10



FESTA

KOMPLET SEKAČA

3x CrV

- 10, 12, 16 mm

Br.	Specifikacija	
19485		10



FESTA

SEKAČ

CrV

Br.	Specifikacija	
19429	200 mm	1



FESTA

SEKAČ

CrV

Br.	specifikacija	širka hrotu	
19410	200 mm	20 mm	10
19411	250 mm	25 mm	10
19412	300 mm	25 mm	10
19418	400 mm	25 mm	5
19419	500 mm	25 mm	5



SEKAČ

CrV

Br.	specifikacija	širka hrotu	
19436	200 mm	20 mm	15

FESTA

KOMPLET PROBIJAČA

CrV 3x



Br.	Specifikacija
19480	Ø 0,8, 1,5, 2,5 mm

10

FESTA

TAČKASTI PROBIJAČ

CrV 3x



Br.	Specifikacija
19481	Ø 0,8, 1,5, 2,5 mm

10

FESTA

KOMPLET PROBIJAČA

CrV 6x



Br.	Specifikacija
19483	Ø 3, 4, 5, 6, 7, 8 mm



5

FESTA

TAČKASTI PROBIJAČ

CrV



Br.	Specifikacija
19477	Ø 2,5 mm

20

FESTA

TAČKASTI PROBIJAČ

CrV



Br.	Specifikacija
19478	Ø 2,5 mm

12

FESTA

PROBIJAČ

CrV



Br.	Specifikacija
19472	Ø 4 mm 150 mm
19473	Ø 5 mm 150 mm
19474	Ø 6 mm 150 mm



1

1

1

REZAČ STAKLA



Br.	Specifikacija
20350	130 mm

12

PROBOJAC SET

- 24690 - Ø 2,5 mm
- Ø 3 mm
- Ø 4 mm
- Ø 5 mm
- Ø 6 mm
- Ø 7 mm
- Ø 8 mm
- Ø 9 mm
- Ø 10 mm
- 24691 - Ø 2 mm
- Ø 2,5 mm
- Ø 3,2 mm
- Ø 4 mm
- Ø 4,8 mm
- Ø 5 mm
- Ø 6,4 mm
- Ø 8 mm
- Ø 9,5 mm
- Ø 11,1 mm
- Ø 12,7 mm
- Ø 14 mm
- Ø 15,8 mm
- Ø 19 mm
- Ø 22 mm



Br.	Specifikacija
24690	9 kom Ø 2,5 - 10 mm
24691	15 kom Ø 2 - 22 mm



10

5

ZUMBE

13x

Br.	Specifikacija
24695	Ø 5, 6, 8, 10, 11, 13, 16, 19, 22, 25, 28, 32, 35 mm



5

UDARNICE BROJEVI

Br.	Specifikacija
20972	6 mm
20973	8 mm

UDARNICE SLOVA

Br.	Specifikacija
20970	6 mm
20971	8 mm



5

5

FESTA
INDUSTRY

**STEGA
STOLARSKA
AUTOMATSKA**

Br.	Specifikacija	
23625	150 mm	6
23626	300 mm	6
23628	450 mm	6
23630	600 mm	6
23632	760 mm	6

NEW
FESTA
INDUSTRY

**PRODUŽNA
SPOJNICA
ZA STEGE**

FESTA INDUSTRY 23625, 23626, 23628, 23630

2x

Br.	Specifikacija	
23635		6

FESTA
**QUICK GRIP
CLAMP**

Br.	Specifikacija	
23570	100 x 80 mm	1
23571	160 x 80 mm	1
23572	200 x 80 mm	1
23573	250 x 80 mm	1
23574	300 x 80 mm	1

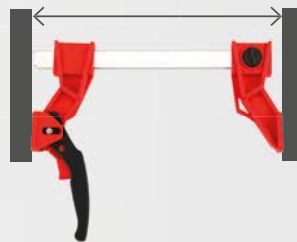
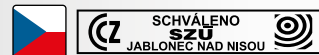
FESTA
STEGA STOLARSKA

Br.	Specifikacija	
23670	150 x 105 mm	1
23671	200 x 105 mm	1
23672	250 x 105 mm	1
23673	300 x 105 mm	1
23674	350 x 105 mm	1
23675	400 x 175 mm	1
23676	500 x 175 mm	1
23677	600 x 175 mm	1
23678	700 x 175 mm	1
23679	800 x 175 mm	1
23680	1000 x 175 mm	1
23681	1250 x 175 mm	1
23682	1500 x 175 mm	1
23683	1750 x 175 mm	1
23684	2000 x 175 mm	1
23685	2200 x 175 mm	1

FESTA
**STEGA
STOLARSKA
AUTOMATSKA**

Br.	Specifikacija	
23585	150 mm	6
23587	300 mm	6
23589	450 mm	6
23591	600 mm	6



FESTA

STEGA
STOLARSKA
AUTOMATSKA

• kovani



Br.	specifikacija	
23560	200 x 80 mm	1
23561	300 x 100 mm	1
23562	400 x 100 mm	1
23563	500 x 120 mm	1
23564	600 x 120 mm	1
23565	800 x 120 mm	1
23566	1000 x 120 mm	1



STEGA STOLARSKA

DIN 5117

Br.	specifikacija	
23506	300 x 120 mm	10
23507	500 x 120 mm	10
23508	800 x 120 mm	6



STEGA STOLARSKA

Br.	specifikacija	
23515	150 x 50 mm	50
23520	200 x 50 mm	50
23525	250 x 50 mm	50
23530	300 x 50 mm	50
23531	300 x 120 mm	20
23551	500 x 120 mm	10



NEW



max. 250 mm



NEW



max. 120 mm

FESTA

HOLZBEARBEITUNGS-
SCHREIBTISCH-KLEMME



Br.	specifikacija	
23595	250/ Ø 20 mm 60 kg	1

FESTA

HOLZBEARBEITUNGS-
SCHREIBTISCH-KLEMME



Br.	specifikacija	
23598	120/ Ø 20 mm 70 kg	1

NEW



FESTA

STEGA
ZA RAMOVE



Br.	specifikacija	
23637	4m x 25mm	1





FESTA

90° ŠKRIPAC



4x

Br.	specifikacija	📦
23607	silastezanja - 250 N	1

ŠKRIPAC
MINI OKRETNI 90°

ALU

0 - 65 mm



Br.	specifikacija	📦
23420	65 mm	20



STEGA

visina tona 80 mm

Br.	specifikacija	📦
23605	9' 230 mm	6

PLASTIČNA STEGA

Br.	specifikacija	📦
23600	4', visina tona 40 mm	20
23601	6', visina tona 70 mm	12
23602	9', visina tona 100 mm	20

STEGA KOMPLET

Br.	specifikacija	📦
23620	25 mm, 50 mm, 75 mm	10



FESTA



208

RADNI STOL



212

STEGE



213

HIDRAULIČNE DIZALICE



218

LED LAMPE

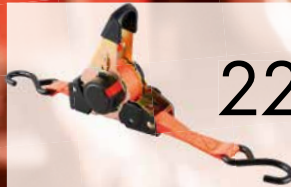

220

ZATEZACI



224

IZOLIR TRAKE PVC



227

LANCI, SAJLE



230

ZAŠITNA OPREMA I
ŠTITNICI ZA KOLJENA

234

POJASEVI ZA ALAT I TORBE



237

KATANCI



239

POSTANSKI SANDUCICI,
SEFOVI

RADIONICA

208 - 243



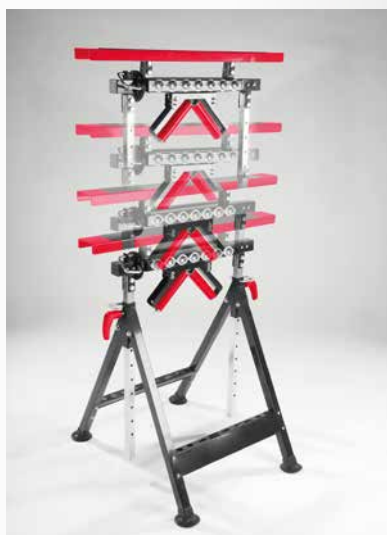

max 200 kg



max 45 kg



max 100 kg



max 100 kg



FESTA

PODESEVI NASLON

· max.: 200 kg

Br. specifikacija
36410



1

NEW

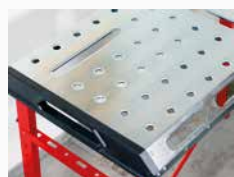

FESTA

**SKLOPIVI STOL
ZA ZAVARIVANJE**

· max.: 450 kg

Br. specifikacija
23652



1

NEW



FESTA

PODESEVI NASLON

· max.: 590 kg

Br. Specifikacije
23657



1



NEW



2x



4x

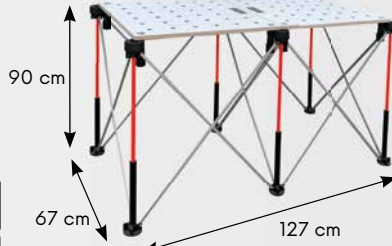

FESTA

**PRENOSNI RADNI STO,
KOMPATIBILAN SA 23664**

- 1270 x 670 x 900 mm
- max.: 1100 kg



1

Br. specifikacija
23661

NEW



FESTA

**RADNA PLOČA,
KOMPATIBILAN SA 23661**

- 1200 x 600 x 18 mm



1

Br. specifikacija
23664



FESTA

PODESEVI NASLON

- max.: 230 kg



1

Br. specifikacija
23658

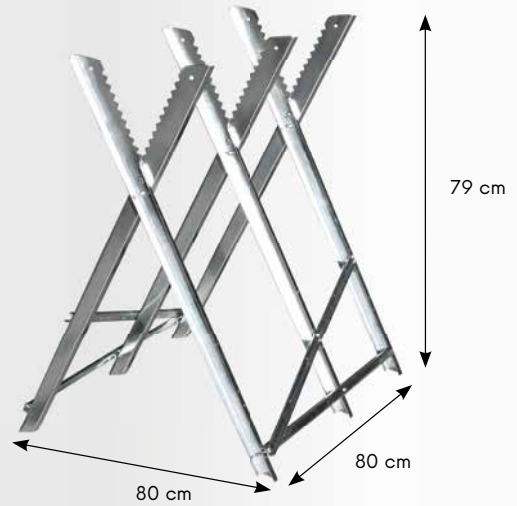

KOZA ZA SEČU DRVA

- max.: 150 kg



1

Br. specifikacija
37570



PODESEVI NASLON

- max.: 125 kg



1

Br. specifikacija
36300



PODESEVI NASLON - PLASTIČNI

- Max. 150 kg (300 kg u paru)

2x

Br. specifikacija
37560

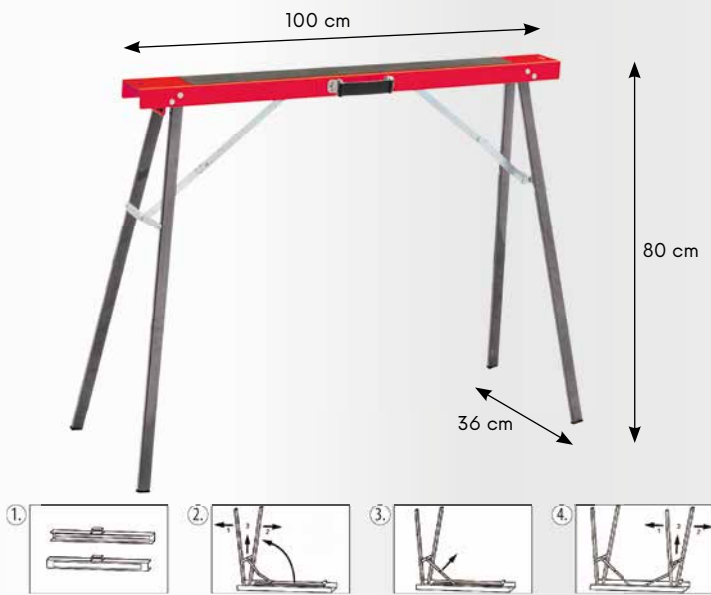

PODESEVI NASLON

· max. 125 kg

2x			
Br.	Specifikacija		
37549	pár	1	

RADNI STO NA SKLAPANJE

· max. 100 kg

Br.	Specifikacija		
23655	100 x 50 x 84 cm	1	



RADNI STO NA SKLAPANJE

· Idealan za podrum kabina

Br.	specifikacija		
23660		1	



RADNI STO NA SKLAPANJE

· max.: 100 kg

Br.	specifikacija		
23650		1	



AUTOMEHANIČARSKA LEŽALJKA

Podstavljeno sjedište sa plastičnom posudom za alat.

Br.	Specifikace		
26988	360 x 365 x 365 mm	1	

FESTA

MAGNETNI DRZAČ



Br.	Specifikacija		
70098		12	



FESTA

POKRETNI ORMAR ZA ALAT

Br.	Putovanja ladice	Crtač	Vanjske dimenzije	
26986	Klizna	7	680 x 460 x 1020 mm	1



POKRETNI ORMAR ZA ALAT

Gornji dio se može umetnuti u donji dio kabine.

Br.	Specifikacija	Putovanja ladice	Crtač	ladice dimenzije	Vanjske dimenzije	Težina	
26985	Gornji dio	Klizna	3	151,5 x 225 x 40 mm	600 x 260 x 340 mm	11,5 kg	1
			2	511 x 225 x 40 mm			
	Donji dio	Klizna	1	511 x 225 x 85 mm	616 x 330 x 742 mm	16,4 kg kg	
			2	511 x 308 x 85 mm			



FESTA

PRENOSIVI ŠKRIPAC

- domet: 0 - 95 cm
- max.: 250 kg



1

Br.	specifikacija
37553	



FESTA

ŠKRIPAC

- Ojačane čeljusti

Br.	specifikacija	1
23410	100 mm	1
23411	125 mm	1
23412	150 mm	1



ŠKRIPAC OKRETNI

- Ojačane čeljusti

Br.	specifikacija	1
23415	100 mm	1
23416	125 mm	1
23417	150 mm	1



ŠKRIPAC MINI OKRETNI

Br.	specifikacija	10
23407	65 mm	10



ŠKRIPAC POD BUŠILICU

- Ojačane čeljusti

Br.	specifikacija	10
23400	18 80 mm	10
23401	22 100 mm	10
23402	24 125 mm	5



ŠKRIPAC MINI OKRETNI 360°

ALU	Br.	specifikacija	24
	23406	80 mm	24

HIDRAULIČNA JEDNORUČNA DIZALICA

Šipka na izvlačenje omogućava malu početnu prilagodljivu visinu i maksimalno podizanje. Dvostruki sigurnosni propusni ventil. Nazubljeni prihvat dizalice omogućava čvrst prihvat uz površinu. Široko postolje osigurava stabilnost i snagu. Sve kritične tačke su pojačane radi produženja roka trajanja dizalice i povećanja sigurnosti



Br.	Nosivost	Minimalna visina	Visina podizanja	Prilagodljiva visina	Dimenzije postolja	Težina	
26800	2 000 kg	181mm	116 mm	48 mm	88 x 92 mm	2,6 kg	1
26801	3 000 kg	194 mm	118 mm	60 mm	92 x 100 mm	3,3 kg	1
26802	5 000 kg	216 mm	127 mm	70 mm	96 x 112 mm	4,5 kg	1
26803	8 000 kg	230 mm	147 mm	80 mm	103 x 118 mm	5,7 kg	1
26804	10 000 kg	230 mm	150 mm	80 mm	110 x 123 mm	6,8 kg	1
26805	12 000 kg	230 mm	155 mm	80 mm	116 x 134 mm	7,3 kg	1
26806	15 000 kg	230 mm	150 mm	80 mm	133 x 136 mm	8,4 kg	1
26807	20 000 kg	242 mm	150 mm	60 mm	144 x 152 mm	11 kg	1



HIDRAULIČNA JEDNORUČNA DIZALICA - TELESKOPSKA

Šipka na izvlačenje omogućava malu početnu prilagodljivu visinu i maksimalno podizanje. Dvostruki sigurnosni propusni ventil. Nazubljeni dosjed dizalice omogućava čvrst prihvat uz površinu. Široko postolje osigurava stabilnost i snagu. Sve kritične tačke su pojačane radi produženja roka valjanosti dizalice i povećanja sigurnosti.



Br.	Nosivost	Minimalna visina	Visina podizanja	Prilagodljiva visina	Težina	
26815	2 000 kg	150 mm	160 mm	60 mm	4,7 kg	1
26816	4 000 kg	160 mm	170 mm	60 mm	6,4 kg	1
26817	6 000 kg	215 mm	270 mm	-	8,9 kg	1
26819	10 000 kg	228 mm	284 mm	89 mm	10,2 kg	1



RUČNA DIZALICA



Br.	Nosivost	Minimalna visina	Maksimalna visina	Težina	
26844	1 000 kg	88 mm	380 mm	2,5 kg	1
26845	2 000 kg	120 mm	395 mm	3,5 kg	1



HIDRAULIČNA PRIJENOSNA DIZALICA – KOLICA



Br.	Specifikacija	Nosivost	Minimalna visina	Maksimalna visina	Težina	
26820		2 000 kg	130 mm	345 mm	9,6 kg	1
26822		3 000 kg	130 mm	465 mm	27,4 kg	1
26826		2 000 kg	89 mm	359 mm	14,2 kg	1
26824		3 000 kg	145 mm	500 mm	37,2 kg	1
26825		2 500 kg	85 mm	455 mm	34,8 kg	1

HIDRAULIČNA PRIJENOSNA DIZALICA – KOLICA + 2 POTPORNJA

Okretna ručka za 360°



Br.	Nosivost	Minimalna visina	Maksimalna visina	Težina	
26829	2 000 kg	130 mm	350 mm	10,5 kg	1
	2 000 kg	275 mm	420 mm	5 kg (pair)	

PODESIVA POTPORNJA DIZALICA

1 kom. = 1 par. Zupčasti prijenos za finu prilagodbu sa dvostrukom kočnicom. Čvrsta čelična ručka. Velik dosjed, sklopna konstrukcija okvira. Postolje od kovanog željeza.



Br.	Specifikacija	Nosivost	Minimalna visina	Maksimalna visina	Težina	
26857	Sa zaporom	2 000 kg	275 mm	420 mm	4,8 kg	1
26858	Sa zaporom	3 000 kg	285 mm	425 mm	6,3 kg	1
26859	Sa zaporom	6 000 kg	393 mm	593 mm	13 kg	1
26853		12 000 kg	465 mm	715 mm	28 kg	1

HIDRAULIČNA KRAN DIZALICA

Za podizanje i fiksiranje dijelova kod montaže i demontaže u automobilima. Nosač kрана ima nekoliko pozicija za izvlačenje. Kran se lako sklapa za skladištenje.

Br.	Nosivost	Minimalna visina	Maksimalna visina	Težina	
26862	2 000 kg	0	2360 mm	88 kg	1



PRENOSNA ŠIPKA ZA DIZANJE

Produljenje za ruku dizalice, ovisno o nagibu. Jamstvo za sigurno i balansirano fiksiranje motora.

Br.	Nosivost	Dužina	Prilagodljivost ruci kрана	Težina	
26871	500 kg	1500 mm	150 mm	20,3 kg	1



PRIJENOSNA DIZALICA

Lagana montaža i demontaža dijelova (motori, prijenosnici, osovine i sl.).

Br.	Specifikacija	Nosivost	Dužina	Prilagodljivost ruci kрана	Težina	
26880	Prijenosna dizalica	500 kg	1100 mm	1900 mm	30,0 kg	1



26880

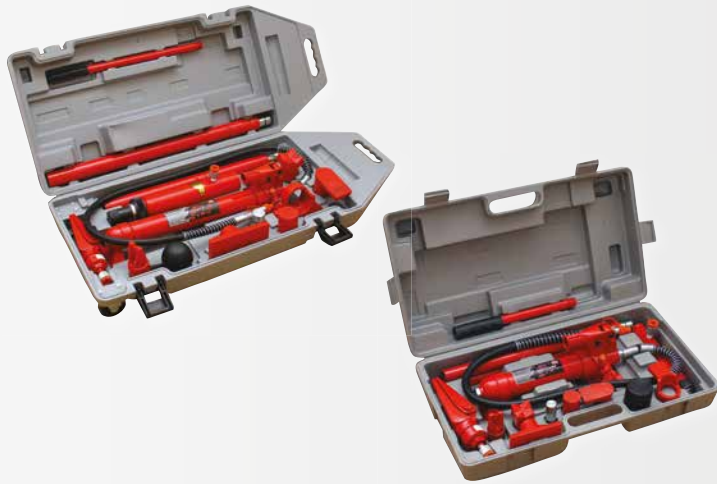

NC KOMPLET

Hidraulična oprema za popravak karoserije vozila. Opremljena stapnim cilindrom sa 14 dodatnih priključaka. Široka primjena u popravcima karoserije automobila i kamiona, naročito u uvjetima rada bez mogućnosti napajanja ostalim izvorima energije. Tijekom upotrebe cilindra, priključci (nastavci) mogu gurati, vući podizati ili izvlačiti u vertikalnom i horizontalnom pravcu. Lako prenosiva oprema u svom koferu.



Br.	Nosivost	Visina podizanja	Težina	
26886	4 000 kg	125 mm	17,0 kg	1
26888	10 000 kg	135 mm	32,0 kg	1



STALAK ZA MOTOR

Pokretni stalak za montiranje i rad na demontiranim motorima. Univerzalna stega za pričvršćivanje motora i njegovo okretanje.



Br.	Nosivost	Težina	
26920	450 kg	20 kg	1



26897



26943

KOMPRESOR ZA OPRUGE

26897 - Za zamjenu Mc Pherson opruga/amortizera na samom vozilu

26943 - Za vađenje Mc Pherson opruga/amortizera iz vozila, hrapavi čelični profili za veću stabilnost



Br.	Nosivost	Ø Promjer komprimirane opruge	Prilagodljivost	Težina	
26897	1 000 kg	100-200 mm	150 mm	24,5 kg	1
26943	1 000 kg	400 mm	210-570 mm	35 kg	1



REZERVOAR ZA ULJE – ISTAKAČ ULJA

Ulje je izvučeno iz motora u spremnik kroz posudu. Spremnik je opremljen opremom za ispušavanje. Ulje može biti ispušano iz spremnika pod tlakom zraka kroz crijevo.



Br.	Kapacitet spremnika	Maks. tlak	Težina	
26954	90 l	0,5 MPa	28 kg	1



HIDRAULIČNI SAVIJAČ CIJEVI

Br.	Nosivost	Visina podizanja	Kalup za savijanje	Težina	
26895	12 000 kg	232 mm	1½", 3¼", 1", 1-1¼", 1-1½", 2"	36 kg	1
26896	16 000 kg	238 mm	1½", 3¼", 1", 1-1¼", 1-1½", 2", 2-1½", 3"	65 kg	1



HIDRAULIČNA PREŠA

Br.	Prilagodljivost	Nosivost	Težina	
26940	0 - 610 mm	12 000 kg	43 kg	1
26941	0 - 880 mm	20 000 kg	75 kg	1

HIDRAULIČNI DUGAČKI KLIP



Br.	Specifikacija	Nosivost	Min. Dužina (mm)	Maks. visina (mm)	Težina	
26911	jednostruka pumpa	5 000 kg	620	1100	12 kg	2
26912	jednostruka pumpa	8 000 kg	620	1100	13 kg	2
26914	dvostruka pumpa	5 000 kg	620	1100	12 kg	2
26915	dvostruka pumpa	8 000 kg	620	1100	14 kg	2



REZERVNI DELOVI ZA KABINET ZA PESKARANJE

Č.p.	
26973	rukavice 1
26974	mlaznice 1
26975	folija 53,5 x 26 cm 1
26976	pleksiglas 60 x 30 cm 1
26977	staklo 60 x 30 cm 1

KABINA ZA PESKARENJE 220L

Br.	Potrošnja zraka	Vanjske dimenzije	Unutarnje dimenzije	Maks. tlak	Težina	
26972	420-710 l/min.	1500 x 830 x 630 mm	600 x 840 x 630 mm	8 bar	38 kg	1

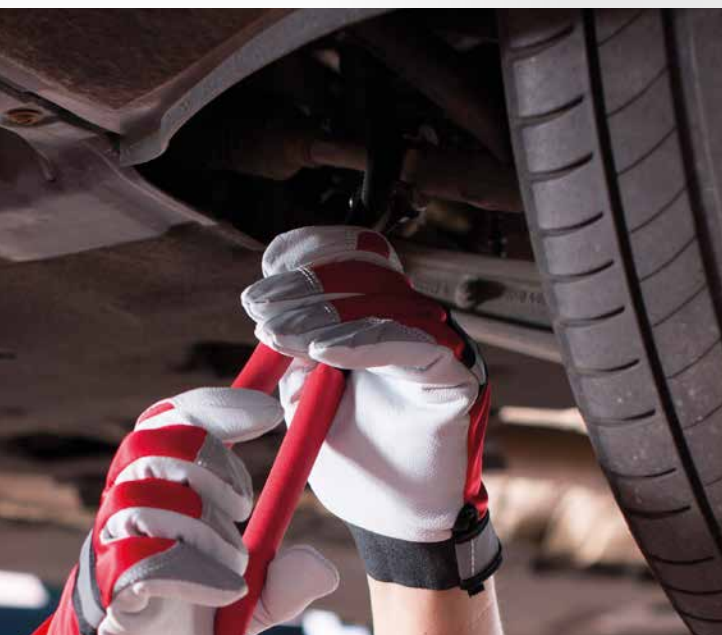

POSUDA ZA PRANJE DELOVA

Za uobičajeno pranje predmeta (delova, mašinskih delova, itd.)



Br.	Kapacitet spremnika	Volumen spremnika za otapala	Protok	Maksimalna temperatura otapala	Težina	
26961	90 l	45 l	10-12 l/min.	50°C	25 kg	1
26963	180l	150 l	20 l/min	50°C	42 kg	1



PUMPICA ZA PODMAZIVANJE

Br.	Specifikacija	
50020	300 ml	10



PUMPA ZA TOVATNU MAST

- bulk loading
- cartridge loading
- plnjeni čerpadlem

Br.	Specifikacija	
50022	400 ml	20



PUMPA ZA ISTAKANJE

Br.	
50017	10



KANTICA ZA ULJE PVC

Br.	Specifikacija	
50019	90 ml	1



KLJUČ ZA SKIDANJE FILTERA

Br.	Specifikacija	
50021	60 x 140 mm	6



LEVAK

Br.	Specifikacija	
50025	60 x 140 mm	50



PRENOSNO CREVO SA SAMOUSAVAJUĆIM VENTILOM

Br.	Dužina	Ø	
50026	180 cm	15 mm	24

MAGNETNI TANJIR



Br.	Specifikacije	
26996	200 x 20 mm	1

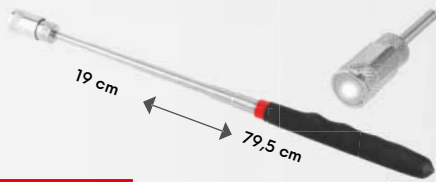

FESTA

MAGNET TELESKOPSKI - LED



Br.	Specifikacije	
13294	3x LR44	6

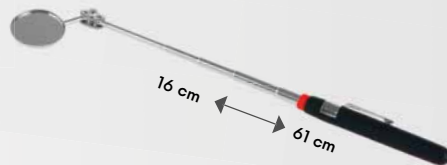

MAJSTORSKO OGLEDALO

Br.	Specifikacije	
13290		20

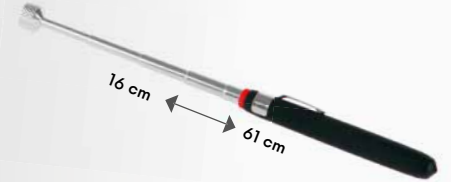

MAGNET TELESKOPSKI



Br.	Specifikacije	
13293		20



ALAT ZA SAKUPLJANJE SMEĆA

· Rotirajuće za 90 °

Br.	Dužina	
61235	81 cm	12

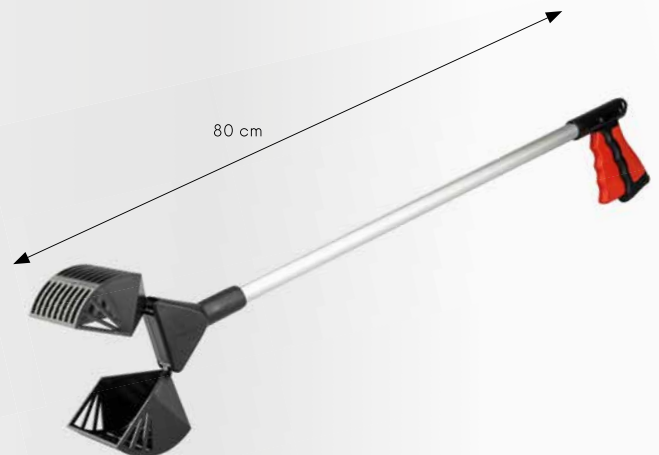

ALAT ZA SAKUPLJANJE SMEĆA

· Max. 4 kg

Br.	
61236	12

FESTA



NEW



FESTA
INDUSTRY

LED LAMPA

3xLED	80, 200, 300 lm	3W COB LED	USB TYPE C	Li-ion 3.7V 0.8Ah	120 min
	0-180°	95g	IK07	IP54	

Br. 37647 Specifikacija 3,7V 800 mAh

1



FESTA
LED LAMPA

Br.	Specifikacija		
37645	200 mm	3 x AAA	12

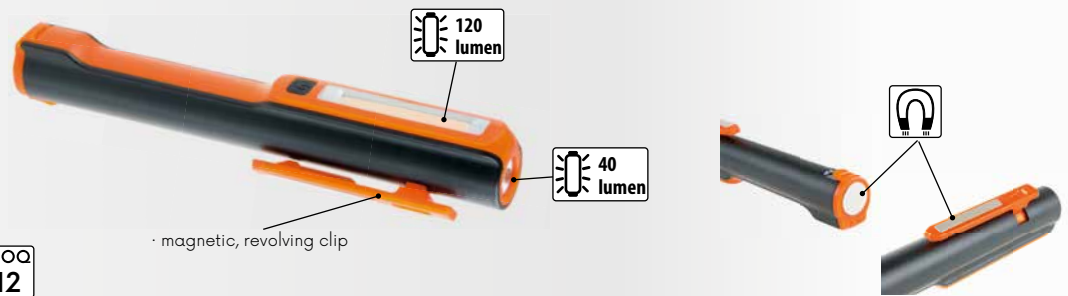

FESTA
NAGLAVNA LED LAMPA

Težina	47 g
izvor osvetljenja	1 x 1 W white LED + 2x red LED
Baterije	3 x AAA
Dimenzije	40 x 59 x 32 mm
Radni sati	45 h
Jačina osvetljenja	120 lumen
Doseg	60 m (100% battery)
Režimi svíceni	4

5 positions					
Br.	Specifikacija				
37641	2 kinds of light, white and red				1

FESTA
LED LAMPA

Br.	Specifikacija		
37630	185 mm	2 x AA	
			20



FESTA
LED LAMPA

Br.	Specifikacija		
37650			12

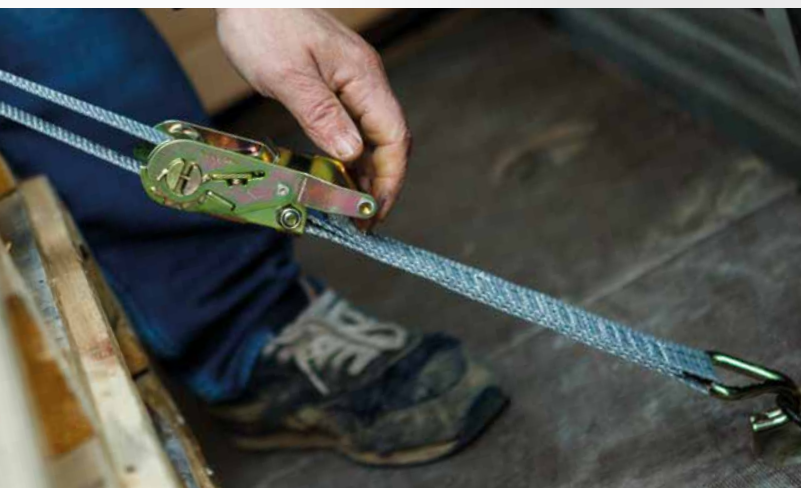

**FESTA**

ZATEZAČ
UNIV.
SA KUKAMA



2x



Br.	Širina	Dužina	kapacitet	Kom	
51070	18 mm	2 m	100 kg	2	12

FESTA

ZATEZAČ
UNIV.
SA KUKAMA



Br.	Širina	Dužina	kapacitet	Kom	
51071	25 mm	3,5 m	300 kg	1	8

**FESTA**

ZATEZAČ
UNIV.
SA KUKAMA



Br.	Širina	Dužina	kapacitet	Kom	
51072	35 mm	4 m	500 kg	1	6

**FESTA**

ZATEZAČ UNIV.
SA KUKAMA



Br.	Širina	Dužina	kapacitet	Kom	
51040	25 mm	6 m	1000 kg	1	1
51041	35 mm	8 m	2000 kg	1	1
51042	35 mm	8 m	3000 kg	1	1
51043	50 mm	10 m	5000 kg	1	1

**FESTA**

ZATEZAČ
UNIV.
SA KUKAMA



Br.	Širina	Dužina	kapacitet	Kom	
51060	25 mm	5 m	750 kg	2	5

**FESTA**

ZATEZAČ UNIV.
SA KUKAMA



Br.	Širina	Dužina	kapacitet	Kom	
51065	50 mm	10 m	960 kg	1	6

**FESTA**

ZATEZAČ UNIV.
SA KUKAMA



Br.	Širina	Dužina	kapacitet	Kom	
51026	75 mm	5 m	3000 kg	1	4

**FESTA**

ZATEZAČ UNIV.

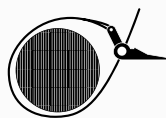

Br.	Širina	Dužina	kapacitet	Kom	
51032	25 mm	5 m	500 kg	1	6

**FESTA**

ZATEZAČ UNIV.
SA KUKAMA



Br.	Širina	Dužina	kapacitet	Kom	
51017	50 mm	6 m	480 kg	2	5
51018	50 mm	6 m	480 kg	1	10





ZATEZAČ UNIV. SA KUKAMA

Br.	Širina	Dužina	Specifikacija	Kom
51022	25 mm	5 m	Kuke	40
51023	50 mm	5 m	Kuke	12

FESTA
ZATEZAČ UNIV.



· Omekšan EVA jastučić

Br.	Širina	Dužina	Kom
51046	38 mm	4 m	1 20



ZATEZAČ UNIV. SA KUKAMA

Br.	Širina	Dužina	Specifikacija	Kom
51030	50 mm	6 m	Kuke	20
51034	50 mm	8 m	Kuke	10

ZATEZAČ UNIV.



2x

Br.	Širina	Dužina	Kom
51020	25 mm	2,5 m	2 100



ZATEZAČ UNIV.

PE

Br.	Širina	Dužina	Kom
51045	25 mm	4 m	1 50

GUMENI ZATEZAČ



2x

Br.	Dužina	Ø	Kom
51013	1,2 m	8 mm	2 1



GUMENI ZATEZAČ

2x

Br.	Dužina	Kom
51008	1 m	2 25



GUMENI ZATEZAČ

Br.	Dužina	Ø	Kom
51009	1 m	10 mm	1 25



SET ZATEZAČA

8x

- 2 x 0,4 m
- 2 x 0,6 m
- 1 x 0,8 m
- 1 x 1,0 m

Br.	Dužina	Ø	Kom
51011	1 m	8 mm	8 10

GUMENI ZATEZAČ



2x

Br.	Dužina	Ø	Kom
51001	80 cm	10 mm	2 50
51002	100 cm	10 mm	2 50
51003	150 cm	10 mm	2 50
51004	200 cm	10 mm	2 50



GUMENI ZATEZAČ

2x

Br.	Dužina	Ø	Kom
51007	1 m	8 mm	2 25

GUMENI ZATEZAČ



Br.	Dužina	Ø	Specifikacija	Kom
51010	80 cm	8 mm	8 kuka	50

GUMENI MREŽA



Br.	Dužina	Širina	
51015	80 cm	120 cm	20

GUMIRANO UŽE



Br.	Dužina	Ø	
51036	20 m	8 mm	10
51037	20 m	10 mm	6

KUKA



20x		
Br.	Ø	
51038	10 mm	30

ALU-KUKA



ALU		MOQ 2	
Br.	Ø	Dužina	
51200	6 mm	60 mm	2
51202	7 mm	70 mm	2
51201	8 mm	80 mm	2
51203	10 mm	100 mm	2

UŽE



Br.	Dužina	Ø	
50915	5 m	8 mm	1
50916	25 m	8 mm	1
50917	25 m	10 mm	1
50918	25 m	12 mm	1
50919	25 m	14 mm	1

NAJLONSKO UŽE



Br.	Dužina	Ø	
51055	80 m	1,5 mm	50
51056	50 m	2 mm	50
51057	20 m	4 mm	50

NAJLONSKO UŽE



Br.	Dužina	Ø	
51050	50 m	8 mm	10
51051	50 m	10 mm	4

PP KANAP



Br.	Težina	
50905	80 g	80
50906	100 g	100
50907	200 g	50

PP KANAP



Br.	Težina	
50909	500 g (250 m)	1
50910	1000 g (500 m)	1
50911	5000 g (2500 m)	1

JUTANI KANAP



Br.	Težina	
50900	80 g (61 m)	1
50901	100 g (76 m)	1
50902	200 g (153 m)	1

KANAP



Br.	Dužina	Ø	
50920	50 m	1 mm	80

VEZICA



1000x		
Br.	Specifikacije	
42365	1,25 100 mm	1
42366	1,25 125 mm	1
42367	1,25 140 mm	1
42368	1,25 160 mm	1

ALAT ZA VEZIVANJE



Br.	Specifikacije	
50052		12
50050		1

ALAT ZA VEZIVANJE



Br.	Specifikacije	
50051		2

VEZICE

50x		EN 50146 nylon	
Br.	Dužina	Širina	
23875	120 mm	4,8 mm	1



VEZICE

100x		EN 50146 Найлон	
Br.	Dužina	Širina	
23880	100 mm	2,5 mm	1
23882	150 mm	2,5 mm	1
23884	200 mm	3,6 mm	1



VEZICE, BIJELE

50x		EN 50146 Найлон	
Br.	Dužina	Širina	
23850	120 mm	2,5 mm	1
23854	200 mm	3,6 mm	1
23856	250 mm	3,6 mm	1
23858	250 mm	4,8 mm	1
23860	300 mm	4,8 mm	1
23864	400 mm	4,8 mm	1
23866	500 mm	4,8 mm	1
23868	400 mm	7,6 mm	1
23870	500 mm	7,6 mm	1



VEZICE, CRNE

50x		EN 50146 Найлон	
Br.	Dužina	Širina	
23810	120 mm	2,5 mm	1
23814	200 mm	3,6 mm	1
23816	250 mm	3,6 mm	1
23818	250 mm	4,8 mm	1
23820	300 mm	4,8 mm	1
23824	400 mm	4,8 mm	1
23826	500 mm	4,8 mm	1
23828	400 mm	7,6 mm	1
23830	500 mm	7,6 mm	1



VEZICE SA DRŠKOM

10x			
Br.	Dužina	Širina	
23865	160 mm	7,5 mm	1



FOLIJA

Br.	Širina	Dužina	Debljina		
38095	500 mm	600 m	8 µm	Transparentno	1
38097	100 mm	150 m	20 µm	Transparentno	1
38096	500 mm	200 m	23 µm	Crn	1

PVC VRECA ZA GRADJEVINSKI OTPAD

Br.	Širina	Dužina	Debljina	kapacitet	Kom	
39194	500 mm	1100 mm	0,16 mm	100 l	1	10
39196	600 mm	1200 mm	0,16 mm	110 l	1	10
39198	700 mm	1100 mm	0,16 mm	120 l	1	10
39200	500 mm	1100 mm	0,20 mm	100 l	1	10
39202	600 mm	1200 mm	0,20 mm	110 l	1	10
39204	700 mm	1100 mm	0,20 mm	120 l	1	10

PVC VRECA ZA GRADJEVINSKI OTPAD

Br.	Širina	Dužina	Debljina	kapacitet	Kom	
39195	500 mm	1100 mm	0,16 mm	100 l	1	10
39197	600 mm	1200 mm	0,16 mm	110 l	1	10
39199	700 mm	1100 mm	0,16 mm	120 l	1	10
39201	500 mm	1100 mm	0,20 mm	100 l	1	10
39203	600 mm	1200 mm	0,20 mm	110 l	1	10
39205	700 mm	1100 mm	0,20 mm	120 l	1	10

KESA ZA DJUBRE

Br.	Širina	Dužina	Debljina	Kom	
38060	700 mm	1100 mm	0,08 mm	10	1
38063	700 mm	1100 mm	0,10 mm	3	1
38065	700 mm	1100 mm	0,20 mm	3	1

KESA ZA DJUBRE

Br.	Širina	Dužina	Debljina	Kom	
38050	500 mm	600 mm	0,04 mm	25	1
38052	600 mm	800 mm	0,04 mm	25	1
38054	700 mm	1100 mm	0,04 mm	25	1

KESA ZA DJUBRE

5x				
Br.	Širina	Dužina	Debljina	
38055	1200 mm	1000 mm	0,08 mm	5



UPOZORAVAJUĆA TRAKA - DALEKOVOD

Br.	Širina	Dužina	
38955	22 cm	20 m	1
38956	22 cm	50 m	1



UPOZORAVAJUĆA TRAKA - VODA

Br.	Širina	Dužina	
38957	22 cm	20 m	1
38958	22 cm	50 m	1



UPOZORAVAJUĆA TRAKA - GASNI

Br.	Širina	Dužina	
38959	22 cm	20 m	1
38960	22 cm	50 m	1



UPOZORAVAJUĆA TRAKA

Br.	Specifikacije	Dužina	
38944	ZAKAZ VSTUPU, SK	80 mm 250 m	8
38945	VSTUP ZAKAZÁN, CZ	80 mm 250 m	8



UPOZORAVAJUĆA TRAKA

Br.	Dužina	
38948	80 mm 250 m	8

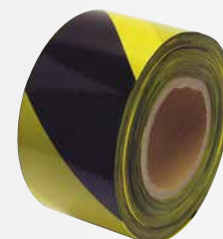

UPOZORAVAJUĆA TRAKA

Br.	Dužina	
38946	80 mm 250 m	8



UPOZORAVAJUĆA TRAKA - SAMOLJEPIVA

Br.	Dužina	Specifikacije	
38947	48 mm 33 m	jel tako	48
38961	48 mm 33 m	levo	48



MARKIRNA TRAKA

Br.	Širina	Dužina	Debljina	
38949	50 mm	50 m	0,15 mm	36

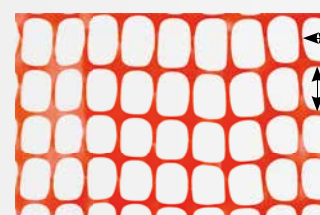

cca 3,5 cm

cca 6,5 cm

SIGURNOSNA OGRADA

140
g/m²



Br.	Specifikacije	
42190	1,2 x 50 m HDPE 140g/m ²	1



TRAKA PVC

5x

Br.	Širina	Dužina	Debljina	
38931	19 mm	5 m	0,13 mm	100



TRAKA PVC, CRNA

Br.	Širina	Dužina	Debljina	
38932	19 mm	10 m	0,13 mm	10



TRAKA PVC

Br.	Širina	Dužina	Debljina	
38925	19 mm	10 m	0,13 mm	10



TRAKA PVC, CRNA

Br.	Širina	Dužina	Debljina	
38968	19 mm	10 m	0,19 mm	10

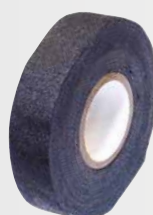

POJAČANA TRAKA CRNA

Br.	Širina	Dužina	
38927	19 mm	10 m	10



TRAKA TEKOMTIL ZA TEPIH

Br.	Širina	Dužina	
38980	48 mm	10 m	24
38981	48 mm	20 m	24



OBOSTRANO LJEPLJIVA TRAKA

Br.	Širina	Dužina	
38924	50 mm	10 m	1
38964	50 mm	25 m	1

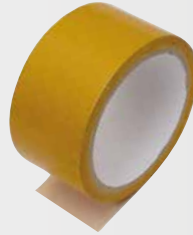

OBOSTRANO LJEPLJIVA TRAKA-PROZIRNA

PP
Polypropylen

Br.	Širina	Dužina	
38929	50 mm	10 m	1
38966	50 mm	25 m	1



OBOSTRANO LJEPLJIVA TRAKA-PROZIRNA

MADE IN EU

Br.	Širina	Dužina	
38990	19 mm	5 m	48
38991	25 mm	5 m	36



PROFESIONALNA DUCT TAPE TRAKA

MADE IN EU

Br.	Širina	Dužina	
38995	48 mm	25 m	24



ALU-TEKOMTIL TRAKA

Br.	Širina	Dužina	
38965	30 mm	10 m	1
38928	50 mm	10 m	72
38934	50 mm	45 m	24



PROFESIONALNA DUCT TAPE TRAKA

blue dolphin tapes

MADE IN EU

Br.	Širina	Dužina	
37275	48 mm	50 m	24



ZAŠTITNA TRAKA ZA FASADU I GIPS

blue dolphin tapes

UV STABLE **MADE IN EU**

Br.	Širina	Dužina	
37271	38 mm	20 m	24
37270	48 mm	20 m	24
37272	48 mm	50 m	24



ZAŠTITNA TRAKA ZA PROZORE

Za 30 dana

UV STABLE **MADE IN EU**

Br.	Širina	Dužina	
37273	48 mm	50 m	24



PAPIRNA MASKIRNA TRAKA PROFI

blue dolphin tapes

MADE IN EU

Br.	Širina	Dužina	
37263	38 mm	50 m	24
37264	48 mm	50 m	24

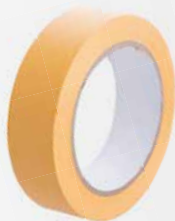

PVC LJEPLJIVA TRAKA

MADE IN EU

Br.	Širina	Dužina	
37266	30 mm	33 m	60
37267	38 mm	33 m	48
37268	50 mm	33 m	36



KREP TRAKA

MADE IN EU

Br.	Širina	Dužina	
37255	19 mm	50 m	12
37256	25 mm	50 m	12
37257	30 mm	50 m	7
37258	38 mm	50 m	6
37259	50 mm	50 m	6



TRAKA PVC

MADE IN EU

Br.	Širina	Dužina	
38942	50 mm	50 m	72



OBLOŽENA KAIŠEVIMA



Br.	Širina	Dužina	
38972	50 mm	50 m	1
38973	50 mm	100 m	1



ALU-SAMOLJEPIVA TRAKA

ALU

Br.	Širina	Dužina	
38963	48 mm	10 m	1
38943	48 mm	45 m	24



TRAKA PROTIV KLIZANJA

Br.	Širina	Dužina	Debljina	
37280	25 mm	15 m	0,8 mm	72
37281	50 mm	15m	0,8 mm	36



TRAKA SAMOVULKANIZIRAJUĆA

Br.	Širina	Dužina	
38930	19 mm	5 m	100



TRAKA SAMOLEPLJIVA (FIBERGLASS)



Br.	Širina	Dužina	
38935	50 mm	20 m	60
38937	50 mm	45 m	36
38939	50 mm	90 m	24
38940	50 mm	153 m	24



FILC STAKLENI



Br.	Širina	Dužina	
38941	50 mm	25 m	40



TRAKA TEFLON

TEFLON

Br.	Širina	Dužina	Debljina	
38969	19 mm	15 m	0,2 mm	10



TRAKA TEFLON

TEFLON

Br.	Širina	Dužina	Debljina	
38933	12 mm	10 m	0,075 mm	10



TEFLON KONAC

Za vodovodne i gasne instalacije

TEFLON

Br.	Širina	Dužina	
38926	2 mm	150 m	20

FESTA

TEFLON KONAC

· 160m
· -20°C ... +130°C
· max 16 bar

NEW



Br.	Specifikacije	
38975		1



DISPENZERI ZA PAKETNU TRAKU

Br.		
38985		1



VELKRO TRAKA

Br.	Specifikacije	
45471	12 mm x 5 m	1



FESTA

VELKRO TRAKA 3 KOM

3x

Br.	Širina	Dužina	
37295	20 mm	150 mm	1
37296	20 mm	200 mm	1
37297	20 mm	250 mm	1

SPANER SRAF

DIN 1480 Zn



Br.	Specifikacije	
50100	5 x 70 mm	10
50101	6 x 90 mm	10
50102	8 x 125 mm	10
50103	10 x 150 mm	10

Br.	Specifikacije	
50104	12 x 200 mm	10
50106	16 x 230 mm	10
50108	20 x 220 mm	10

KARABINJER

DIN 5299 C Zn



Br.	Specifikacije	
51204	4 mm	10
51205	5 mm	10
51206	6 mm	10
51207	7 mm	10
51208	8 mm	10

Br.	Specifikacije	
51209	9 mm	10
51210	10 mm	10
51211	11 mm	10
51212	12 mm	10

KARIKA NA NAVOJ

Zn



Br.	Specifikacije	
51241	4 mm	10
51242	5 mm	10
51243	6 mm	10
51244	7 mm	10

Br.	Specifikacije	
51245	8 mm	10
51246	10 mm	10
51247	12 mm	10

"S" KUKA

Zn



Br.	Specifikacije	
51271	3 mm	10
51272	4 mm	10
51273	5 mm	10
51274	6 mm	10

Br.	Specifikacije	
51275	7 mm	10
51276	8 mm	10
51278	10 mm	10

MATICA OKO

DIN 5820 Zn



Br.	Specifikacije	
51320	6 mm	10
51321	8 mm	10
51322	10 mm	10
51323	12 mm	10

Br.	Specifikacije	
51324	14 mm	10
51325	16 mm	10
51327	20 mm	10

SRAF OKO

DIN 5820 Zn



Br.	Specifikacije	
51300	6 mm	10
51301	8 mm	10
51302	10 mm	10
51303	12 mm	10
51304	14 mm	10

Br.	Specifikacije	
51305	16 mm	10
51306	18 mm	10
51307	20 mm	10
51308	22 mm	10



KARABINJER

Zn

Br.	Specifikacije	
51220	53 mm	10
51221	67 mm	10
51222	76 mm	10



OKRETNI KARABINER

Zn

Br.	Specifikacije	
51225	3,8 mm	10
51226	4,5 mm	10
51227	6,0 mm	10



SPOJNICA ZA SAJLE I ZICU

DIN 5685 C Zn

Br.	Specifikacije	
51341	Ø 10 mm	10



ZABICA ZA SAJLU

Zn

No.	specification	
51280	3 mm	10
51281	5 mm	10
51282	6 mm	10
51283	8 mm	10
51284	10 mm	10
51286	12 mm	10
51287	14 mm	10
51288	16 mm	10



OMCA ZA SAJLU

Zn

Br.	Specifikacije	
51258	Ø 16 mm	10
51259	Ø 18 mm	10
51260	Ø 20 mm	10
51261	Ø 22 mm	10
51262	Ø 24 mm	10
51264	Ø 28 mm	10

LANČANA DIZALICA – KOTUR

Br.	Nosivost	Minimalna visina	Visina podizanja	Broj koluta	lanac	Težina	
26700	500 kg	280 mm	3 000 mm	1	6 mm	7,5 kg	1
26701	1 000 kg	300 mm	3 000 mm	1	6 mm	9 kg	1
26702	2 000 kg	380 mm	3 000 mm	2	6 mm	12 kg	1



ZATEZAČ ZA OGRADE

Br.	Specifikacije	
50035	2 t	6
50036	4 t	4



LANAC KRATKA KARIKA



DIN 5685 A Zn

Br.	Veličina očiju	Dužina	
51402	2 x 10 mm	110 m	1
51403	3 x 16 mm	60 m	1
51404	4 x 21 mm	40 m	1
51405	5 x 23 mm	30 m	1



LANAC

DIN 5686 Zn

Br.	Ø	Dužina		Br.	Ø	Dužina	
51430	1,4 mm	150 m	1	51433	2,0 mm	118 m	1
51431	1,6 mm	150 m	1	51435	2,5 mm	70 m	1
51432	1,8 mm	130 m	1	51436	2,8 mm	50 m	1



LANAC DUGA KARIKA

DIN 5685 C Zn

Br.	Veličina očiju	Dužina	
51412	2 x 12 mm	80 m	1
51413	3 x 26 mm	60 m	1
51414	4 x 32 mm	38 m	1
51415	5 x 35 mm	32 m	1



LANAC PLASTIČNI



Br.	Specifikacije	
51450	6 mm 25 m Crveno-beli	1



RUČNA DIZALICA

Zn

Br.	Kapacitet	Dužina lana	
26720	300 kg	8 m	1
26705	450 kg	8 m	1
26721	500 kg	8 m	1
26722	800 kg	8 m	1
26706	900 kg	8 m	1
26707	1350 kg	8 m	1



STALAK ZA SAJLE I LANCE

Br.	Specifikacije	
51196	Promotional stand for chains staffed	10
51197	Promotional stand for ropes staffed	10
51198	Promotional stand for chains	10
51199	Promotional stand for ropes	10



SAJLA ČELIČNA

Zn

Br.	Ø	Dužina	
51100	Ø 1 mm	500 m	1
51102	Ø 1,5 mm	500 m	1
51103	Ø 2 mm	200 m	1
51104	Ø 3 mm	200 m	1
51105	Ø 4 mm	100 m	1
51106	Ø 5 mm	75 m	1
51107	Ø 6 mm	75 m	1
51130	Ø 8 mm	75 m	1
51131	Ø 10 mm	50 m	1
51132	Ø 12 mm	50 m	1



SAJLA SA PVC

Zn

Br.	Ø	Dužina	
51108	Ø 2/3 mm	200 m	1
51109	Ø 3/4 mm	100 m	1
51110	Ø 4/5 mm	75 m	1
51111	Ø 5/6 mm	50 m	1



SAJLA ČELIČNA INOX

INOX

Br.	Ø	Dužina	
51120	Ø 1 mm	300 m	1
51121	Ø 1,2 mm	300 m	1
51122	Ø 1,5 mm	300 m	1
51123	Ø 2 mm	200 m	1
51124	Ø 3 mm	200 m	1
51125	Ø 4 mm	100 m	1
51126	Ø 5 mm	75 m	1
51127	Ø 6 mm	75 m	1



NAVOJNA ŠIPKA

DIN 975 **Zn**

4.8 · Klasa tvrdoće

Br.	specifikacija	
55040	M 4 1 m	200
55050	M 5 1 m	150
55060	M 6 1 m	100
55080	M 8 1 m	50
55100	M 10 1 m	20
55120	M 12 1 m	20
55140	M 14 1 m	15
55160	M 16 1 m	15
55180	M 18 1 m	10
55200	M 20 1 m	10
55220	M 22 1 m	5
55240	M 24 1 m	5
55300	M 30 1 m	5



NAVOJNA ŠIPKA

DIN 976 **INOX** **4.8** · Klasa tvrdoće

Br.	specifikacija	
55315	M 12 1 m	20
55316	M 14 1 m	15
55317	M 16 1 m	15
55318	M 18 1 m	10
55319	M 20 1 m	10



before after



NAVOJNA ŠIPKA

DIN 975 **4.8** · Klasa tvrdoće

Br.	specifikacija	
55051	M 5 1 m	150
55181	M 18 1 m	10
55201	M 20 1 m	10
55221	M 22 1 m	5



FESTA SREDSTVO ZA ČIŠĆENJE IVICA

Ø 3 - 19 mm

1/4"

Br.	Specifikacija	
16321		5



MATICE

DIN 934 **Zn**

4.8 · Klasa tvrdoće

Br.	specifikacija	
55350	M 4 100 kom.	1
55351	M 5 100 kom.	1
55352	M 6 100 kom.	1
55353	M 8 100 kom.	1
55354	M 10 100 kom.	1
55355	M 12 100 kom.	1
55356	M 14 100 kom.	1
55357	M 16 100 kom.	1
55358	M 18 100 kom.	1
55359	M 20 10 kom.	1
55360	M 22 10 kom.	1
55361	M 24 10 kom.	1
55362	M 30 10 kom.	1



PODLOŠKE

DIN 440R **Zn**



Br.	specifikacija	
55331	M 5 100 kom.	1
55332	M 6 100 kom.	1
55333	M 8 100 kom.	1
55334	M 10 100 kom.	1
55335	M 12 100 kom.	1
55336	M 14 100 kom.	1
55337	M 16 100 kom.	1
55339	M 20 10 kom.	1
55340	M 22 10 kom.	1
55341	M 24 10 kom.	1
55342	M 30 10 kom.	1



FESTA KUTIJA ZA ORGANIZATORE



Br.	Specifikacija	
55650	375 x 290 x 67 mm	1



VIJCI ZA DRVO KOPLET

2000x

Br.	Specifikacije	
55640	2000 Kom	1



Kom	
350	3,0 x 16 mm
280	3,0 x 20 mm
220	3,0 x 25 mm
250	3,5 x 20 mm
240	3,5 x 25 mm
180	3,5 x 3, mm
280	4,0 x 16 mm
80	4,0 x 30 mm
40	4,0 x 40 mm
30	4,0 x 50 mm
25	5,0 x 50 mm
25	5,0 x 60 mm

VIJCI ZA DRVO + TIPLI

vijci za drvo

Kom	
40	3,5 x 30 mm
25	4,0 x 40 mm
12	5,0 x 50 mm
8	6,0 x 60 mm

tipli

Kom	
40	5 x 25 mm
25	6 x 30 mm
12	8 x 40 mm
8	10 x 50 mm

170x

Br.	Specifikacije	
55645		1



VIJCI ZA DRVO

Kom	
60	3,0 x 12 mm
50	3,0 x 16 mm
40	3,0 x 20 mm
50	3,5 x 20 mm
40	3,5 x 30 mm
25	4,0 x 30 mm
20	4,0 x 40 mm
15	5,0 x 50 mm
10	5,0 x 60 mm

310x

Br.	Specifikacije	
55642		1





ZAŠTITNE NAOČARE

CE EN
166

Br. specifikacija 10



ZAŠTITNE NAOČARE

CE EN
166

Br. specifikacija 10



ZAŠTITNE NAOČARE

Podesimo dužina drškama

CE EN
166

Br. specifikacija 12



ZAŠTITNE NAOČARE

CE EN
170

Br. specifikacija 12
tamne



ZAŠTITNE NAOČARE

CE EN
166

Br. specifikacija 1



ZAŠTITNE SLUŠALICE

CE EN
352 27
dB

Br. specifikacija 1



ZAŠTITNE SLUŠALICE

CE EN
352 27
dB

Br. specifikacija 1



ZAŠTITNA MASKA ZA LICE

CE EN
166

Br. specifikacija 10



ZAŠTITNA MASKA ZA LICE

CE
EN 1731

Br. specifikacija 10



ŠTITNICI ZA UŠI

Br. specifikacija 100



ŠTITNICI ZA UŠI

Br. specifikacija 100



ZAŠTITNI ŠLEM CLIMAX

CE EN
397 EU

Br.	specifikacija	
50550	Plav	30
50551	Crvena	30
50553	Bijela	30
50554	Žuta	30



REFLEKTUJUĆI PRSLUK

CE EN
20471

Br.	specifikacija	
50570	Narandžasti	100
50571	Žuti	100



ZAŠTITNA KOLICA ZA KOLENA

Br.	specifikacija	
37135		1



FESTA
ŠTITNIK ZA KOLENA

Br.	specifikacija	
37145	gel	8



FESTA
ŠTITNIK ZA KOLENA

Br.	specifikacija	
37140	gel	12



FESTA
ŠTITNIK ZA KOLENA

Br.	specifikacija	
37144	gel	12



FESTA
ŠTITNIK ZA KOLENA

Br.	specifikacija	
37143		12



FESTA
ŠTITNIK ZA KOLENA

Br.	specifikacija	
37142	komfort	20



ŠTITNIK ZA KOLENA

Br.	specifikacija	
37139	neopren	10



ŠTITNIK ZA KOLENA

Br.	specifikacija	
37141		6





RUKAVICE KOŽNE OJAČANE

· Sa oblogom na dlanu



Br.	specifikacija	
50518	Veličina 11"	12



RUKAVICE KOŽNE OJAČANE

· Sa oblogom na dlanu



Br.	specifikacija	
50519	Veličina 10,5"	12



KOŽNE RUKAVICE



Br.	specifikacija	
50520	Veličina 10,5"	12



PAMUČNE RUKAVICE SA PVC TAČKICAMA

Br.	specifikacija	
50524	Veličina 10"	12



PAMUČNE RUKAVICE MOČENE U PVC



Br.	specifikacija	
50525	Veličina 10" - délka 35 cm	12



RUKAVICE POLYESTER SA PVC TAČKICAMA

· Sa PVC terčikama

Br.	specifikacija	
50526	Veličina 10"	12



PAMUČNE RUKAVICE SA LATEX SLOJEM



Br.	specifikacija	
50522	Veličina 10"	12



NAJLON NITRILNE RUKAVICE



Br.	specifikacija	
50533	Veličina 10"	12



NAJLON RUKAVICE PREMAZANE LATEX PENOM



Br.	specifikacija	
50535	Veličina 8"	12
50536	Veličina 9"	12
50537	Veličina 10"	12



NAJLON RUKAVICE PREMAZANE NITRIL PENOM

· Sa PVC terčikama



Br.	specifikacija	
50539	Veličina 10"	12



AKRILNE ŽIMSKE RUKAVICE PRESUČENELATEXOM



Br.	specifikacija	
50529	Veličina 10"	12



RUKAVICE



Br.	specifikacija	
50557	Veličina 7"	12
50558	Veličina 8"	12
50549	Veličina 9"	12



PAMUČNE RUKAVICE SA PVC TAČKICAMA

· Sa PVC terčikama

Br.	specifikacija	
50531	Veličina 9"	12



NAJLON RUKAVICE OD KOZIJE KOŽE



Br.	specifikacija	
50541	Veličina 9"	12
50542	Veličina 10"	12



NAJLON RUKAVICE OD SVINJSKE KOŽE



Br.	specifikacija	
50544	Veličina 10"	12



NAJLONSKE RUKAVICE UMOČENA U POLIURETAN



Br.	specifikacija	
50527	Veličina 10"	12



KOŽNE RUKAVICE ZA ZAVARIVANJE



Br.	specifikacija	
50540	Veličina 11"	12



JEDNOKRATNE VINYL RUKAVICE

· bistro, bez praha



Br.	specifikacija	
50532	Veličina 9"	100



MASKA ZAŠTITNA



Br.	specifikacija	
50500	FFP2 without valve	30



MASKA ZAŠTITNA



Br.	specifikacija	
50503	FFP2 with valve	20



ZAŠTITNI KOMBINEZON SA KAPULJAČOM

Br.	specifikacija	
50585	Veličina M	1
50586	Veličina L	1
50587	Veličina XL	1
50588	Veličina XXL	1



ZÁSTĚRA NA SVAŘOVÁNÍ



Br.	specifikacija	
50555	Koža	1

· Kvalitetna metalna ručka sa podstavom

· Udoban remen za odvajanje ramena



· Remen sa čičkom za nošenje dugih alata.

· Vyztužená unutra konstrukce

· 18 džepovima

FESTA**TORBA ZA ALAT SA METALNOM RUČKOM**

Br.	visina	dužina	dubina	
37331	280 mm	490 mm	230 mm	2

**FESTA****TAŠKA**

Br.	širina	visina	dubina	
37332	480 mm	290 mm	250 mm	1

FESTA**TORBA ZA ALAT**

Br.	širina	visina	dubina	
37330	610 mm	400 mm	270 mm	5

FESTA**FESTA****POJAS ZA ALAT**

· Ojačani džepovi



Br.	specifikace	
37325		10

**FESTA****POJAS ZA ALAT**

· Ojačani džepovi



Br.	specifikace	
37326		12

**FESTA****KAIŠ**

Br.	specifikace	
37328	145 cm	20



FESTA

PLANINARSKI KAIŠ

· 14 džepovima + oko

Br.	délka	šifka	
37311	120 cm	6 cm	1



FESTA

KAIŠ NAJLONSKI

Br.	délka	šifka	
37310	120 cm	6 cm	1



FESTA

POJAS ZA ALAT

· 8 džepovima

Br.	šifka	výška	
37320	300 mm	250 mm	1



FESTA

POJAS ZA ALAT

· 4 džepovima

Br.	šifka	výška	
37321	350 mm	300 mm	1



FESTA

RADNIČKA JAKNA ZA ALAT

Br.	specifikace	
37350		20



FESTA

POJAS ZA ALATE KOŽA



Br.	specifikacija	
37302	6 džepovima	50
37303	11 džepovima	25



POJAS ZA ALATE KOŽA



Br.	specifikacija	
37300	6 džepovima	50
37301	11 džepovima	25



FESTA



TORBA ZA ALAT KOŽNA PROFI



Br.	výška	délka	dubina	
37342	270 mm	430 mm	180 mm	1



TORBA ZA ELEKTRIČARE KOŽNA PROFI



Br.	výška	délka	dubina	
37341	260 mm	430 mm	200 mm	1



TORBA ZA ALAT KOŽNA SA OJAČANIM DNOM



Br.	výška	délka	dubina	
37340	240 mm	430 mm	150 mm	1



TORBA ZA ALAT

Br.	výška	délka	dubina	
37344	250 mm	300 mm	130 mm	1



TORBA ZA ALAT SA OJAČANIM DNOM

Br.	výška	délka	dubina	
37343	240 mm	430 mm	150 mm	1



TORBA ZA ELEKTRIČARE

Br.	výška	délka	dubina	
37345	270 mm	430 mm	180 mm	1

DRŽAČ ALATA „O“



Br.	specifikacija
37308	20



DRŽAČ ALATA „U“



Br.	specifikacija
37309	20





FESTA
UMETAK ZA BRAVU



Br.	Specifikacija	
23001	65 mm · 175 g	10



UMETAK ZA BRAVU
PUNKTOVAN NIKEL



Br.	Specifikacija	
23000	65 mm · 75 g	15



FESTA
KATANAC



Br.	Specifikacija	
23261	25 mm	6
23262	32 mm	12
23263	38 mm	6
23264	45 mm	6
23265	52 mm	12
23266	63 mm	6



FESTA
KATANAC MS



Br.	Specifikacija	
23125	25 mm	12
23130	30 mm	12
23135	35 mm	12
23140	40 mm	12
23150	50 mm	12
23160	60 mm	12



FESTA
KATANAC MS



Br.	Specifikacija	
23310	30 mm	10
23311	40 mm	10
23312	50 mm	6



FESTA
KATANAC PRODUŽENI



Br.	Specifikacija	
23211	25 mm	12
23212	32 mm	12
23213	38 mm	6
23214	45 mm	6
23215	52 mm	6



FESTA
KATANAC SIGURNOSNI



Br.	Specifikacija	
23274	60 mm	6
23275	70 mm	12

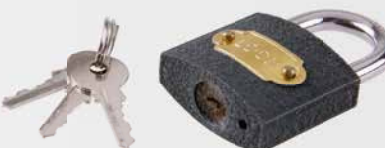

KATANAC ČELIČNI



Br.	Specifikacija	
23220	25 mm	6
23225	30 mm	6
23232	32 mm	6
23240	40 mm	6
23250	50 mm	6
23260	60 mm	6



KATANAC MS



Br.	Specifikacija	
23020	20 mm	12
23025	25 mm	12
23030	30 mm	12
23035	35 mm	12
23040	40 mm	12
23050	50 mm	12
23060	60 mm	12





KATANAC MS PRODUŽENI



Br.	Specifikacija	
23070	40 mm	12

KATANAC ČELIČNI



Br.	Specifikacija	
23010	50 mm	6

KATANAC OTPORAN NA VODU



Br.	Specifikacija	
23005	40 mm	6
23006	50 mm	6



FESTA

KATANAC ZA BICIKLE



Br.	Specifikacija	
23288	120 cm x Ø 10 mm	1



FESTA

KATANAC ZA BICIKLE



Br.	Specifikacija	
23287	65 cm x Ø 10 mm	1



FESTA

KATANAC ZA BICIKLE



Br.	Specifikacija	
23290	120 cm x Ø 8 mm	1
23291	150 cm x Ø 8 mm	1
23292	180 cm x Ø 8 mm	1



KATANAC ZA BICIKLE



Br.	Specifikacija	
23282	55 cm x Ø 8 mm	50
23284	65 cm x Ø 8 mm	50



KATANAC SA ŠIFROM



Br.	Specifikacija	
23281		20





FESTA

SEF SA ELEKTRONSKOM BRAVOM



- Tip brave: elektronska, mehanička
- Bezbedonosni ključ
- Dimenzije 350k250k250mm
- Težina 10 kg



Br.	Specifikacija	
23270		1

REZA ZA KATANAC

Br.	Specifikacija	
51514	100 mm	25
51515	120 mm	25
51516	140 mm	25
51517	160 mm	25



REZA

Br.	Specifikacija	
51510	100 mm	12
51511	120 mm	12
51512	140 mm	12
51513	160 mm	12



FESTA

PLASTICNI PRIVESAK

100x

· Jak krug



Br.	
23391	50

PLASTICNI PRIVESAK

100x



Br.	
23390	1

KUTIJA ZA KLJUČEVE



Br.	Specifikacija	
70140	250 x 180 x 80 mm - za 48 ključeva	12
70141	300 x 230 x 90 mm - za 90 ključeva	8

BLAGAJNA



Br.	Širina	Dubina	Visina	
70120	125 mm	95 mm	60 mm	1

BLAGAJNA



Br.	Širina	Dubina	Visina	
70121	152 mm	118 mm	80 mm	36

BLAGAJNA



Br.	Širina	Dubina	Visina	
70122	200 mm	160 mm	90 mm	20

BLAGAJNA



Br.	Širina	Dubina	Visina	
70123	250 mm	180 mm	90 mm	16



BLAGAJNA



Br.	Širina	Dubina	Visina	
70124	300 mm	240 mm	90 mm	10



BLAGAJNA



Br.	Širina	Dubina	Visina	
70125	370 mm	280 mm	90 mm	8



POŠTANSKO SANDUČE



Br.	Boja	Širina	Visina	Dubina	
70101	Belo	290 mm	360 mm	105 mm	5
70100	Smeđa	290 mm	360 mm	105 mm	5



POŠTANSKO SANDUČE



Br.	Boja	Širina	Visina	Dubina	
70102	Belo	310 mm	260 mm	90 mm	10
70103	Smeđa	310 mm	260 mm	90 mm	10



POŠTANSKO SANDUČE



Br.	Boja	Širina	Visina	Dubina	
70105	Smeđa	310 mm	360 mm	90 mm	5



POŠTANSKO SANDUČE



Br.	Boja	Širina	Dubina	Visina	
70108	Belo	370 mm	134 mm	364 mm	5



POŠTANSKO SANDUČE



Br.	Širina	Dubina	Visina		
70107	INOX	360 mm	100 mm	520 mm	6



POŠTANSKO SANDUČE



Br.	Širina	Dubina	Visina		
70106	INOX	360 mm	100 mm	360 mm	5



POŠTANSKO SANDUČE



Br.	Širina	Dubina	Visina		
70109	INOX	310 mm	90 mm	260 mm	6



POŠTANSKO SANDUČE



Br.	Širina	Dubina	Visina		
70110	INOX	310 mm	90 mm	360 mm	6

VAGA RUČNA

Br.	Nosivost		
24260	50 kg	10	



VAGA RUČNA

Br.	Nosivost	
24212	12,5 kg	12
24225	25 kg	6
24250	50 kg	6
24255	100 kg	6
24258	150 kg	6



PINCETA SA LED SVETLOM

Br.	Specifikacija	
50005	95 mm	8



SET PINCETA INOX

Br.	Specifikacija	
50004		1

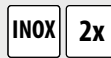

MIŠOLOVKA

Br.	Specifikacija	
70221	90 x 45 mm Drvena	1



MIŠOLOVKA

Br.	Specifikacija	
70220	97 x 47 mm Plastična	48



SAJLA ZA KANALIZACIJU

· mogućnost upotrebe sa bušilicom

Br.	Dužina	Ø	
50014	6 m	6 mm	6



Ø 15 mm

SAJLA ZA KANALIZACIJU

Br.	Dužina	
50010	3 m	10
50011	5 m	5
50012	10 m	3
50013	15 m	4



Ø 20mm

Ø 10mm



SAJLA ZA KANALIZACIJU

Br.	Dužina	Ø	
50009	3 m	5 mm	40



Ø 5mm

PUMPA ZA ČIŠĆENJE SLIVNIKA

Br.	Dužina	Ø	
50015	385 mm	65 mm	30



ELEKTRICARSKA VODJICA ZA KABLOVE

Br.	Dužina	Ø	
51181	8 m	5 mm	25
51182	10 m	5 mm	25





244

GLETERICE, SPAHLE



250

FANGLE



254

STRUGALICA



255

GLETERICE DRVENE



257

GLETERICE PLASTIČNE



261

MEŠAČI



266

MEŠALICE



269

PUNILAC GRAĐEVINSKIM
OTPADOM

269

GRAĐEVINSKA KOLICA



270

ALATI HORIZONT



272

DRŽAČ IVIČNJAKA



274

REZAČI PLOČICA



277

ALATI ZA POLAGANJE
PLOČICA

280

NIVELING PRIBOR



286

KAJLE I SITA



292

ALATI ZA GIPSANE ZIDOVE



294

BRENERI I REGULATORI



296

KANTE I POSUDE ZA GIPS



297

PIŠTOLJ ZA SILIKON



299

PIŠTOLJ ZA PUR



300

ČETKA I VALJAK ZA
FARBANJE

305

PE FOLIJA



306

MERDEVINE



307

STUBOVI, VRATA ZA
DIMNJAK

GRAĐEVINSKI ALAT

242 - 307



**FESTA**

GLETARICA
GLATKA
280 X 130 MM



· Gumena drška



Br.	Specifikacije	
31140	Glatka	10

FESTA

GLETARICA
GLATKA
280 X 130 MM



· Gumena drška



Br.	Specifikacije	
31148	Glatka	10

FESTA

GLETARICA
280 X 130 MM
NAZUBLJENA



· Gumena drška



Br.	Specifikacije	
31146	Ø 16	10

FESTA

GLETARICA
280 X 130 MM
NAZUBLJENA



· Gumena drška



Br.	Specifikacije		Br.	Specifikacije	
31141	e 4	10	31144	e 10	10
31142	e 6	10	31145	e 12	10
31143	e 8	10			

FESTA

GLETARICA
280 X 130 MM
NAZUBLJENA



Br.	Specifikacije		Br.	Specifikacije	
31101	e 4	10	31131	e 10	10
31111	e 6	10	31132	e 12	10
31121	e 8	10			

FESTA

GLETARICA
280 X 130 MM



Br.	Specifikacije	
31091	Glatka	10

FESTA

GLETARICA
280 X 130 MM

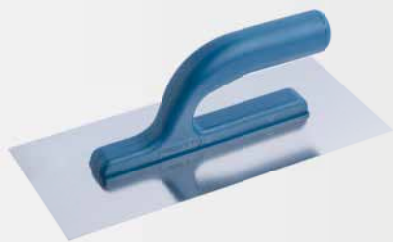

Br.	Specifikacije	
31011	Glatka	10

FESTA

GLETARICA
280 X 130 MM
NAZUBLJENA



Br.	Specifikacije		Br.	Specifikacije	
31021	e 4	10	31051	e 10	10
31031	e 6	10	31053	e 12	10
31041	e 8	10			

GLETARICA
270 X 125 MM



Br.	Specifikacije	
31005	Glatka	25

GLETARICA
270 X 125 MM
NAZUBLJENA



Br.	Specifikacije		Br.	Specifikacije	
31006	e 4	24	31008	e 8	24
31007	e 6	24	31009	e 10	24

FESTA

GLETARICA
360 X 130 MM



Br.	Specifikacije	
31151	Glatka	10

FESTA

GLETARICA
360 X 130 MM



Br.	Specifikacije	
31150	Glatka	10

FESTA

GLETARICA
480 X 130 MM



Br.	Specifikacije	
31082	Glatka	10

FESTA

GLETARICA
680 X 130 MM



Br.	Specifikacije	
31155	Glatka	10

FESTA

GLETARICA
NAZUBLJENA
500 X 130 MM



Br.	Specifikacije	
31052	e 4	10
31061	e 6	10
31062	e 8	10
31071	e 10	10
31072	e 12	10

FESTA

GLETARICA
GLATKA
500 X 130 MM



Br.	Specifikacije	
31081	Glatka	10



FESTA**MISTRIJA ROŠT FREI,
GUMENA DRŠKA**

INOX · Gumena drška



Br.	Specifikacije	
31232	120 mm	10
31233	140 mm	10

Br.	rozméry	
31234	160 mm	10
31235	180 mm	10

FESTA**MISTRIJA ROST FREI**

INOX



Br.	Specifikacije	
31220	120 x 80 mm	10
31221	140 x 80 mm	10

Br.	Specifikacije	
31222	160 x 115 mm	10
31231	180 x 120 mm	10

FESTA**MISTRIJA OKRUGLA ROST FREI,
GUMENA DRŠKA**

INOX · Gumena drška



Br.	Specifikacije	
31334	160 x 100 mm	10

FESTA**MISTRIJA OKRUGLA
ROST FREI**

INOX



Br.	Specifikacije	
31343	160 x 100 mm	10

FESTA**MISTRIJA ZIDARSKA ROST FREI,
GUMENA DRŠKA**

INOX · Gumena drška



Br.	Specifikacije	
31360	40 mm	10
31380	60 mm	10
31390	80 mm	10

Br.	Specifikacije	
31400	100 mm	10
31403	120 mm	10

FESTA**MISTRIJA ZIDARSKA
ROST FREI**

INOX



Br.	Specifikacije	
31362	40 mm	10
31382	60 mm	10

Br.	Specifikacije	
31392	80 mm	10
31402	100 mm	10
31404	120 mm	10

FESTA**MISTRIJA OKRUGLA ROST FREI,
GUMENA DRŠKA**

INOX · Gumena drška



Br.	Specifikacije	
31330	140 x 50 mm	10
31340	160 x 60 mm	10

FESTA**MISTRIJA OKRUGLA
ROST FREI**

INOX



Br.	Specifikacije	
31332	140 x 50 mm	10
31341	160 x 60 mm	10

FESTA**MISTRIJA UGAONA ROST FREI,
GUMENA DRŠKA**

INOX · Gumena drška



Br.	Specifikacije	
31280	80 x 60 x 60 mm	10

FESTA**MISTRIJA UGAONA
ROST FREI**

INOX



Br.	Specifikacije	
31281	80 x 60 x 60 mm	10

FESTA**MISTRIJA UGAONA ROST FREI,
GUMENA DRŠKA**

INOX · Gumena drška



Br.	Specifikacije	
31270	80 x 60 x 60 mm	10

FESTA**MISTRIJA UGAONA
ROST FREI**

INOX



Br.	Specifikacije	
31271	80 x 60 x 60 mm	10

FESTA

MISTRIJA ŠPICASTA ROST FREI,
GUMENA DRŠKA

INOX • Gumena drška

Br.	Specifikacije	
31320	140 x 75 mm	10



FESTA

MISTRIJA ŠPICASTA
ROST FREI

INOX

Br.	Specifikacije	
31322	140 x 75 mm	10



FESTA

MISTRIJA
KOCKASTA

INOX

Br.	Specifikacije	
31218	180 mm e 6	12



FESTA

ŠPAKLA ROST FREI,
GUMENA DRŠKA

• Gumena drška

INOX

Br.	Specifikacije	
31510	40 mm	10
31511	60 mm	10
31512	80 mm	10



FESTA

STRUGALICA,
NAOSTRENIH IVICA

• Gumena drška
• Ojačana sečiva

INOX

Br.	Specifikacije	
32173	75 mm	10



FESTA

STRUGALICA,
NAOSTRENIH IVICA

• Držalje 52010
• Ojačana sečiva

INOX

Br.	Specifikacije	
32170	100 mm	12



FESTA

ŠPAKLA, BIT

• Gumena drška

INOX

Br.	Specifikacije	
31455	150 mm	12
31456	200 mm	12

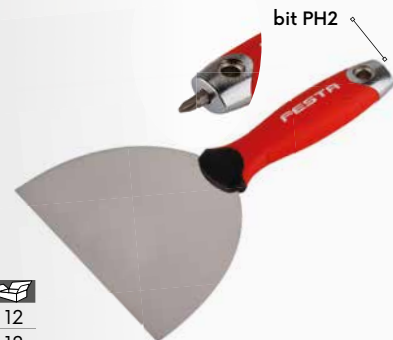

FESTA

ŠPAKLA ROST FREI,
GUMENA DRŠKA

INOX

Br.	Specifikacije	
31517		10



FESTA

ŠPAKLA FASADNA
POJAČANA

• Gumena drška

INOX

Br.	Specifikacije	
31505	200 mm	5
31506	250 mm	5
31507	300 mm	5



**FESTA****STRUGALICA, NAOSTRENIH IVICA**

· Ojačana sečiva

INOX

Br.	Širina	Dužina	
32174	100 mm	500 mm	1

FESTA**ŠPAKLA ROST FREI****INOX**

R.s.	Ieirás	
31461	40 mm	12
31471	60 mm	12
31481	80 mm	12
31491	100 mm	12
31467	120 mm	12
31468	140 mm	12

**FESTA****ŠPAKLA ROST FREI****INOX**

Br.	Specifikacije	
31498	150 mm	12
31499	200 mm	12
31500	100 mm	12

**ŠPAKLA TVRDA ROST FREI****INOX**

MADE IN EU

Br.	Specifikacije	
31493	40 mm	20
31494	60 mm	20
31495	80 mm	20
31496	100 mm	20

**ŠPAKLA**

R.s.	Ieirás	
32176	30 mm	12
32186	40 mm	12
32196	50 mm	12
32206	60 mm	12
32216	80 mm	12
32226	100 mm	12
32234	125 mm	12

**ŠPAKLA KOMPLET****3x**

Br.	Specifikacije	
32240	30, 50, 80 mm	10

**FESTA****ŠPAKLA**

Br.	Specifikacije		Br.	Specifikacije	
32161	30 mm	10	32171	90 mm	10
32162	40 mm	10	32166	100 mm	10
32163	50 mm	10	32172	110 mm	10
32164	60 mm	10	32167	120 mm	10
32169	70 mm	10	32168	140 mm	10
32165	80 mm	10			

**VALJAK ZA NANOŠENJE GLET MASE**

- drška 180 mm - 52630
- drška 250 mm - 52625
- Držači 52010, 52011, 52012, 52020, 52030



Br.	Specifikacije				
52611	250 mm	Ø 8 mm	Ø 48 mm	50	
52612	180 mm	Ø 8 mm	Ø 48 mm	10	

FESTA

ŠPAKLA
ZA ZAPTIVANJE NA
CELOJ POVRŠINI

INOX

R.s.	Izírás	
31555	35 cm	1
31556	45 cm	1
31557	60 cm	1
31558	80 cm	1
31559	100 cm	1



FESTA

TELESKOPSKA RUČKA

konac za 31610, 34203

Br.	Specifikacije	
52011	88 - 140 cm	1



FESTA

DRŽAČ LOPATICE
ZA ZAPTIVANJE
CELE POVRŠINE

za 31555 - 31559
ručka 52010, 52011, 52012, 52020, 52030

Br.	Specifikacije	
31610		1



LOPATICA
NEHRĐAJUĆI ČELIK
S POJAČANJEM

INOX

MADE IN EU

Br.	Specifikacije	
31520	400 mm	1
31521	500 mm	
31522	600 mm	



ručka 61254



31523



31524

LOPATICA NEHRĐAJUĆI ČELIK S
POJAČANJEM - PRIBOR

MADE IN EU

Br.	Specifikacije	
31523	ALU ručka	1
31524	plastična ručka	1

ŠPAKLA
FASADNA
ROST FREI

INOX

Br.	Specifikacije	
31552	400 mm	10
31553	600 mm	10



ŠPAKLA
FASADNA
ROST FREI

INOX

MADE IN EU

Br.	Specifikacije	
31541	250 mm	1
31551	250 mm Uska	1



GLETARICA GLATKA CRNA

Br.	Specifikacije	
32062	280 x 160 mm	10
32060	500 x 140 mm	5

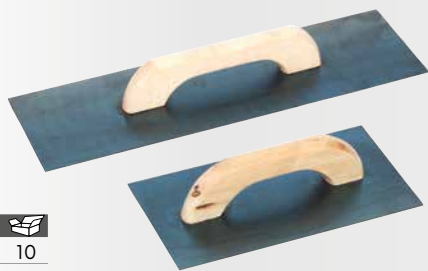

GLETARICA GLATKA ŠPICASTA

Br.	Specifikacije	
32064	500 x 90 mm	5
32066	550 x 140 mm	5



MISTRIJA

Br.	Specifikacije	
32015	160 x 130 mm	10
32014	180 x 130 mm	10
32016	200 x 140 mm	10



MISTRIJA KOCKASTA

Br.	Specifikacije	
32001	160 x 110 mm	10
32002	160 x 130 mm	10
32003	180 x 130 mm	10
32013	200 x 140 mm	10



MISTRIJA

Br.	Specifikacije	
32018	160 x 110 mm	10



MISTRIJA

Br.	Specifikacije	
32024	140 x 80 mm	12



MISTRIJA OKRUGLA

Br.	Specifikacije	
32020	140 x 65 mm	12
32021	140 x 40 mm	12



MISTRIJA

Br.	Specifikacije	
32026	140 x 85 mm	12



FESTA

FANGLA ROST FREI

INOX

Br.	Specifikacije	
32285	Ø 180 mm	1



FESTA

FANGLA

Zn

Br.	Specifikacije	
32265	Ø 180 mm	10



FESTA

FANGLA CRNA

Br.	Specifikacije	
32273	Ø 160 mm	10
32283	Ø 180 mm	10
32293	Ø 215 mm	10



FANGLA PLASTIČNA



Br.	Specifikacije	
32270	Ø 160 mm	1



KUTLAČA ZA MALTER

· Pogodna drška 61215

Br.	Specifikacije	
32302	Ø 180 mm	1
32313	Ø 215 mm	1
32301	Ø 235 mm	1



KUTLAČA ZA MALTER

· Pogodna drška 61200, 61201

Br.	Specifikacije	
32268	Ø 215 mm	1
32269	Ø 235 mm	1
32296	Ø 215 mm	1



MOTIKA ZA MALTER

Br.	Specifikacije	
60100	motika za malter 295 x 150 mm	24
61169	motika za malter sa drškom 160 cm	3
61218	Drška 160 cm	5



KUTLAČA ZA MALTER SA DRŽALJOM

MOQ 3

Br.	Specifikacije	
32295	Ø 180 mm držalje 160 cm	3
32297	Ø 215 mm držalje 160 cm	3
32298	Ø 235 mm držalje 160 cm	3



STRUGALICA ZA YTONG

Br.	Specifikacije	
32037	600 mm	1



UGAO ZA SEČENJE YTONG

Br.	Specifikacije	
32038	270 x 270 x 270 mm	1



MISTRIJA ZA YTONG

Br.	Specifikacije	
32089	150 mm	1



FESTA

SEKAČ

CrV	Br.	specifikacija	širka hrotu	
	19406	300 mm	25 mm	5
	19407	400 mm	30 mm	5



FESTA

ŠPIC

CrV	Br.	specifikacija	
	19408	250 mm	5
	19409	350 mm	5



FESTA

SEKAČ

CrV	Br.	specifikacija	širka hrotu	
	19460	300 mm	25 mm	5
	19470	400 mm	30 mm	5



ŠPIC

Br.	specifikacija	
19400	250 mm	5
19403	350 mm	6



SEKAČ

Br.	specifikacija	širka hrotu	
19401	250 mm	19 mm	6
19404	350 mm	22 mm	6



SEKAČ

Br.	specifikacija	širka hrotu	
19402	250 mm	50 mm	2
19405	350 mm	50 mm	6



NEW

FESTA

ŠPAKLA
ROST FREI

INOX

Br. 31519 Specifikacije 75 mm

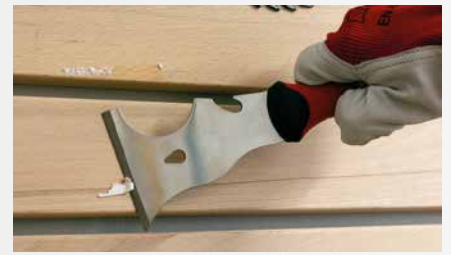

ŠPAKLA ROST FREI

INOX

Br. 31497 Specifikacije 63 x 195 mm



FESTA

NOŽ ZA TAPETE

INOX

Br. 31503 Specifikacije 150 mm



STRUGALICA ZIDARSKA

MADE IN EU

Br. 31501 Specifikacije 100 mm



31502 Rezervni nož 1

ŠPAKLA
ZA GIPSANE PLOČE

PLASTIC

Br.	Specifikacije	
34308	50 mm	20
34307	80 mm	12
34306	100 mm	10
34305	150 mm	12



DRŽAC BRUSNE SMIRGLE

Br.	Specifikacije	
34301	230 x 105 mm	1
34304	235 x 80 mm	1



FESTA

DRŽAČ BRUSNE MREŽICE

Br.	Specifikacije	
34200	210 x 115 mm	30
34201	240 x 105 mm	50
34202	240 x 80 mm	50



DRŽAČ BRUSNE MREŽICE

· Držalje 52030

ALU

Br.	Specifikacije	
34203	230 x 80 mm aluminium	1
52030	Štap teleskopski	12

BRUSNA
SMIRGLA

10x

Br.	Specifikacije	
34271	115 x 290 mm zrn. 120	80
34272	115 x 290 mm zrn. 100	80
34273	115 x 290 mm zrn. 80	80
34274	93 x 290 mm zrn. 120	80
34275	93 x 290 mm zrn. 100	80
34276	93 x 290 mm zrn. 80	80

BRUSNA
SMIRGLA

3x

Br.	Specifikacije	
34280	115 x 290 mm zrn. 120	20
34281	115 x 290 mm zrn. 100	20
34282	115 x 290 mm zrn. 80	20
34283	93 x 290 mm zrn. 120	20
34284	93 x 290 mm zrn. 100	20
34285	93 x 290 mm zrn. 80	20

FESTA

ŠPAKLA JAPANKA

4x

Br.	Specifikacije	
31452	Rost frei 50, 80, 100, 120 mm	10
31453	Čelik 50, 80, 100, 120 mm	10

FESTA

ŠPAKLA JAPANKA

4x

Br.	Specifikacije	
31454	50, 80, 100, 120 mm	12

ČELIČNA LOPATICA

Br.	Specifikacije	
31601	180 mm - Ravna	1
31602	180mm A1	1
31603	180mm A2	1
31641	180 mm - e4	1

ŠPAKLA INOX

Br.	Specifikacije	
31651	250 mm - Ravna	1
31655	250 mm - e4	1

GLADILICA PVC

Br.	Specifikacije	
37101	125 x 85 mm	100
37111	170 x 115 mm	100

GLADILICA PVC

Br.	Specifikacije	
37051	Ravna	1
37031	zub - 4 x 6 mm	1
37041	zub - 6 x 6 mm	1

MISTRIJA

Br.	Specifikacije	
32022	140 x 80 mm	12
32023	125 x 40 mm	12

GLETARICA JEDNOSTRANA

Br.	Specifikacije	
32040	10 mm	20
32041	12 mm	20
32042	15 mm	20
32043	18 mm	20
32044	20 mm	20

GLETARICA ZA FUGE DVOSTRANA

Br.	Specifikacije	
32050	10 12 mm	50
32051	10 15 mm	50
32052	10 18 mm	50
32053	15 20 mm	50

FESTA**STRUGALICA
DRVENA
ZA YTONG**

· Topole

MOQ
2

Br. 32317 Specifikacije 450 x 95 mm

2

FESTA**STRUGALICA DRVENA
ZA YTONG
FINI ZUB**

· Topole

MOQ
2

Br. 32312 Specifikacije 450 x 95 mm

2

FESTA**STRUGALICA
DRVENA
ZA YTONG**

· Topole

MOQ
2

Br. 32337 Specifikacije 260 x 95 mm

2

FESTA**STRUGALICA DRVENA
ZA YTONG
FINI ZUB**

· Topole

MOQ
2

Br. 32338 Specifikacije 260 x 95 mm

2

**FESTA****STRUGALICA
ZA YTONG**

· Topole

MOQ
2

Br. 32327 Specifikacije 230 x 145 mm

2

**STRUGALICA
DRVENA
ZA YTONG**MADE IN
EUMOQ
2

Br. 32332 Specifikacije 450 x 95 mm

2

**STRUGALICA
ZA YTONG**MADE IN
EUMOQ
2

Br. 32333 Specifikacije 230 x 145 mm

2

FESTA**STRUGALICA**MADE IN
EUMOQ
2

Br. 32314 Specifikacije 400 x 180 mm

2

FESTA**STRUGALICA**MADE IN
EUMOQ
2

Br. 32329 Specifikacije 270 x 130 mm

2

STRUGALICAMADE IN
EUMOQ
2

Br. 33168 Specifikacije 380 x 160 mm

2

FESTA**STRUGALICA
DRVENA**MOQ
2

Br. 32320 Specifikacije 400 x 180 mm

2

STRUGALICA



Br.	Specifikacije	
32311	400 x 180 mm	2

FESTA

GLADILICA BRUSNA



Br.	Specifikacije	
32318	400 x 180 mm	2
32319	500 x 250 mm	2
32321	400 x 180 mm P 16 brus. papir	10
32322	500 x 250 mm P 16 brus. papir	10

FESTA

PLASTIČNA BRUSNA GLETARICA



Br.	Specifikacije	
32324	270 x 130 mm P 16	2
32323	270 x 130 mm P 16 brus. papir	10

FESTA

PLASTIČNA BRUSNA GLETARICA



Br.	Specifikacije	
32330	400 x 180 mm	2
32331	270 x 130 mm	2

STRUGALO ZA KAMENU VUNU

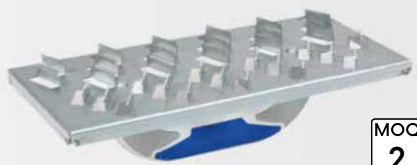

Br.	Specifikacije	
32328	285 x 145 mm	10

FESTA

GLETARICA SA CELICNIM TRAKAMA



Br.	Specifikacije	
32325	225 x 105 mm	2

STRUGALICA MREŽASTA

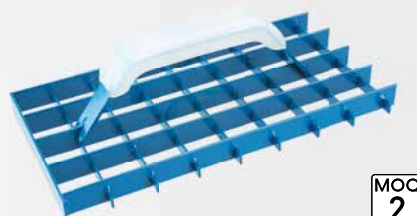

Br.	Specifikacije	
32316	280 x 150 mm	20



STRUGALICA MREŽASTA

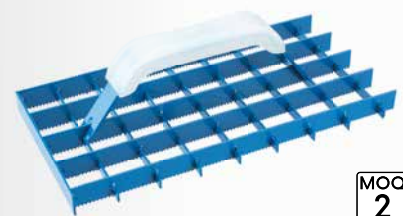

Br.	Specifikacije	
32335	290 x 145 mm	2

STRUGALICA ALU

· 8 nožići



Br.	Specifikacije	
32326	450 x 90 mm	20

STRUGALICA ZA GIPS.PLOČE

· 6 nožići



Br.	Specifikacije	
32315	270 x 90 mm	30

FESTA

GLETARICA PLASTIČNA



Br.	Specifikacije	
34027	400 x 180 mm	20

GLETARICA PLASTIČNA

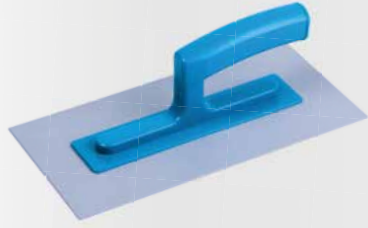

Br.	Specifikacije	
34028	400 x 180 mm	20

FESTA**GLETARICA
PLASTIČNA
ABS**MADE IN
EU

Br.	Specifikacije	
34041	280 x 140 - 2 mm	10
34051	280 x 140 - 3 mm	10
34053	280 x 140 - 3 mm Nazubljen - e6	10

FESTA**GLETARICA
PLASTIČNA**

Č.p.	specifikace	
30003	270 x 125 mm	28
30004	235 x 115 mm	35
30005	210 x 115 mm	38
30007	210 x 60 mm	44

FESTA**GLETARICA
DRVENA**

· Lipovo drvo



Br.	Specifikacije	
34005	400 x 145 mm	40
34007	290 x 145 mm	20

**GLETARICA
DRVENA**

· topolovo drvo



Br.	Specifikacije	
34006	400 x 145 mm	40

**GLETARICA
POLIURETANSKA**MADE IN
EU

Br.	Specifikacije		Br.	Specifikacije	
34122	120 x 240 mm	50	34154	220 x 420 mm	15
34132	140 x 280 mm	40	34155	240 x 480 mm	15
34142	180 x 320 mm	25	34156	280 x 500 mm	10
34152	200 x 360 mm	20	34157	330 x 330 mm	5
34121	80 x 260 mm Zakošeno	50	34158	120 x 800 mm	5
34153	100 x 400 mm	30	34159	120 x 1000 mm	5
			34160	120 x 1200 mm	5

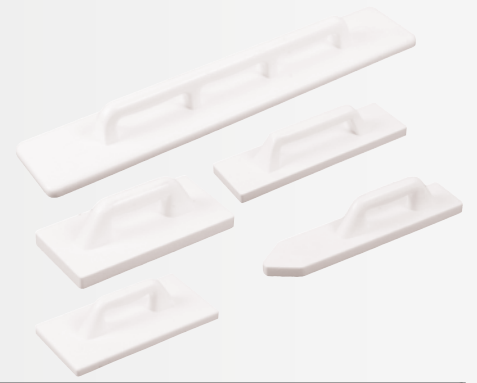
**PERDAŠKA OD
STIROPORA**MADE IN
EU

Br.	Specifikacije	
34101	80 x 350 mm Zakošeno	10
34061	130 x 270 mm	10
34111	170 x 320 mm	10
34071	130 x 450 mm	10
34081	140 x 750 mm	10
34091	140 x 900 mm	5

**GLETARICA
POLIURETANSKA**

Br.	Specifikacije	
34115	140 x 280 mm	36
34116	180 x 320 mm	36
34117	200 x 360 mm	24

**LETVA
ZA BETON**MADE IN
EU

Br.	Specifikacije	
15889	980 x 380 mm Držalje Ø 32 mm	1

Ø 23 mm

**SPAHLA SA GUMOM**

Br.	Specifikacije	
15886	450 mm Držalje Ø 23 mm	48
15887	600 mm Držalje Ø 23 mm	48
15888	750 mm Držalje Ø 23 mm	32

Ø 32 mm

**LETVA ZIDARSKA**MADE IN
EU

Br.	Specifikacije	
15885	100 x 800 mm Držalje Ø 32 mm	1

MATERIJAL PREDNJA STRANA	BETON		ŽBUKA/ FASADA			LJEPILA I MASE ZA FUGIRANJE	LJEPILO ZA FASADE	PRIMJENA
	GRUBO	POTĚROVÝ	TVRDA	MEKANA	MEKANA ZA YTONG			
CRNI FILC (SMEDI, SIVI)				••••		••		Za fino ravnanje fasade, koristi se za veće granulacije fasade.
BIJELI FILC				••••	••••	••••		Za fino ravnanje fasade, koristi se za manje granulacije fasade.
FINI MOLITAN				••••	••••	••••		Za eliminaciju pijeska na površini, za zaglađivanje finih materijala.
GRUBI MOLITAN				••••	••••	••••		Za eliminaciju pijeska na površini, za zaglađivanje grubih materijala.
RASTER MOLITAN				••••	••••	••••		Za eliminaciju pijeska, zahvaljujući rasteru pruža mogućnost boljeg zaglađivanja grubih materijala.
MORSKA SPUŽVA					•••		••••	Ispiranje spojnih materijala, za tanke spojeve (fuge), eliminacija pijeska u spoju.
HYDRO SPUŽVA FINA, GRUBA					•		••••	Ispiranje spojnih materijala, za debele spojeve (fuge), eliminacija pijeska u spoju.
SPUŽVA				••	••••	••	••••	Ispiranje spojnih materijala, zaglađivanje mekih fasada.
MIKROGUMA							••••	Za fugiranje
GUMENA PJENA							••••	Za fugiranje
MIRELON		••••	•••					Obrada betona, izvlačenje i fino ravnanje.
DUREN				••••	••	••••		Za ravnanje spojeva svježe fasade.
DRVO	••••	••••	••••					Obrada betona, izvlačenje i fino ravnanje.
ČELIČNI LIM	••	••••		••		••••	••	Zaglađivanje betona
STIROPOR	•••	••••	•••	••			••	Obrada betona, izvlačenje i fino ravnanje.
POLYURETHAN	••••	••••	••••					Obrada betona, izvlačenje i fino ravnanje.
ABS		••		••••	••••	••••	••••	Navlačenje sepa na fasadu, razvlačenje fine mekane fasade.
GLADILICA ROST FREI RAVNA				••••	••••	••••	••••	Razvlačenje fine mekane fasade, nanošenje ljepila za stiropor na fasadu.
GLADILICA ROST FREI NAZUBLJENA							••••	Nanošenje ljepila za elemente pročelja i podova.
STRUGALICA ZA STIROPOR PLASTIČNA			••				••••	Brušenje polistirena, cementnog ljepila, betona, fasade i gipsa.
STRUGALICA ZA STIROPOR DRVENA			••				••••	Brušenje fasadnog polistirena.

**FESTA**

GLETARICA
SA BELIM
FILCOM



Č.p.	specifikace	
34400	280 x 140 x 8 mm	15
34415	250 x 130 x 8 mm	15
34450	220 x 130 x 8 mm	15
34445	220 x 70 x 8 mm	20

**FESTA**

GLETARICA
PLASTIČNA
SA CRNIM FILCOM



Č.p.	specifikace	
34401	280 x 140 x 10 mm	15
34416	250 x 130 x 10 mm	15
34451	220 x 130 x 10 mm	15
34446	220 x 70 x 10 mm	20

**FESTA**

GLETARICA
SA FINIM
MOLITANOM



Č.p.	specifikace	
34404	280 x 140 x 30 mm	10
34485	280 x 130 x 20 mm	10
34486	250 x 130 x 30 mm	10
34419	250 x 130 x 20 mm	10
34453	220 x 130 x 20 mm	10
34447	220 x 70 x 20 mm	10

**FESTA**

GLETARICA
SA FINIM
SUNĐEROM



Č.p.	specifikace	
34405	280 x 140 x 18 mm	15
34420	250 x 130 x 18 mm	15
34454	220 x 130 x 18 mm	15
34449	220 x 70 x 18 mm	20
34480	280 x 140 x 12 mm	15
34481	250 x 130 x 12 mm	15
34482	220 x 130 x 12 mm	15

**FESTA**

GLETARICA
SA EKOMTRA FINIM
SUNĐEROM

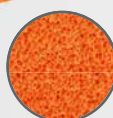

Br.	Specifikacije	
34443	280 x 140 x 12 mm	15
34442	250 x 130 x 12 mm	15

**FESTA**

GLETARICA
SA GRUBIM
SUNĐEROM



Br.	Specifikacije	
34441	280 x 140 x 12 mm	15
34440	250 x 130 x 12 mm	15
34439	250 x 130 x 18 mm	15



FESTA

GLETARICA
SA REZ.
MOLITANOM



Br.	Specifikacije	
34409	280 x 140 x 30 mm	10
34425	250 x 130 x 20 mm	10

FESTA

GLETARICA
SA GRUBIM
MOLITANOM



Br.	Specifikacije	
34410	280 x 140 x 30 mm	10
34426	250 x 130 x 20 mm	10

FESTA

GLETARICA
SA MORSKIM
SUNĐEROM



Č.p.	specifikace	
34406	280 x 140 x 30 mm	10
34421	250 x 130 x 30 mm	10
34455	220 x 130 x 30 mm	10

FESTA

GLETARICA
SA REZ.MORSKIM
SUNĐEROM



Č.p.	specifikace	
34413	280 x 140 x 30 mm	10
34428	250 x 130 x 30 mm	10

FESTA

GLETARICA
SA HIDRO
SUNĐEROM



Č.p.	specifikace	
34412	280 x 140 x 30 mm	10
34424	250 x 130 x 30 mm	10
34458	220 x 130 x 30 mm	10

FESTA

GLETARICA
SA REZ.HIDRO
SUNĐEROM



Č.p.	specifikace	
34490	280 x 140 x 30 mm	10
34491	250 x 130 x 30 mm	10

FESTA

GLETARICA
SA FINIM HID.
SUNĐEROM



Č.p.	specifikace	
34411	280 x 140 x 30 mm	10
34423	250 x 130 x 30 mm	10
34457	220 x 130 x 30 mm	10

FESTA

GLETARICA
SA GUMENOM
PENOM



Č.p.	specifikace	
34402	280 x 140 x 10 mm	15
34417	250 x 130 x 10 mm	15
34452	220 x 130 x 10 mm	15

FESTA

GLETARICA
SA MIKRO
GUMOM



Č.p.	specifikace	
34403	280 x 140 x 8 mm	15
34418	250 x 130 x 8 mm	15
34496	220 x 130 x 8 mm	15

FESTA

GLETARICA
SA DURENOM



Č.p.	specifikace	
34407	280 x 140 x 20 mm	10
34422	250 x 130 x 20 mm	10
34456	220 x 130 x 20 mm	10
34448	220 x 70 x 20 mm	10

FESTA

GLETARICA
SA RUVENOM



Č.p.	specifikace	
34414	280 x 140 x 20 mm	10
34429	250 x 130 x 20 mm	10

FESTA

GLETARICA
PLASTIČNA



Č.p.	specifikace	
30003	270 x 125 mm	28
30004	235 x 115 mm	35
30005	210 x 115 mm	38
30007	210 x 60 mm	44

FESTA**GLETARICA
ZA FUGOVANJE**MADE IN
EU

Č.p.	specifikacije	
34033	240 x 95 mm	5

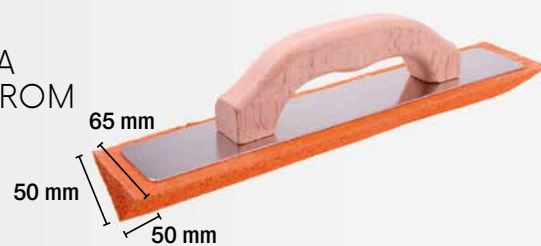
**GLETARICA
SA SUNĐEROM
90°**

Č.p.	specifikacije	
34500	350 mm	6

**REZERVNI
PLIŠ**MADE IN
EU

Č.p.	specifikacije	
34241	280 x 140 x 8 mm	1
34223	250 x 130 x 8 mm	1

**REZERVNI
FILC**MADE IN
EU

Č.p.	specifikacije	
34243	280 x 140 x 10 mm	1
34221	250 x 130 x 10 mm	1

**REZERVNI
SUNĐER**MADE IN
EU

Č.p.	specifikacije	
34262	280 x 140 x 18 mm	1

**REZERVNI
MOLITAN**MADE IN
EU

Č.p.	specifikacije	
34251	280 x 140 x 30 mm	1

**REZERVNI
MOLITAN**MADE IN
EU

Br.	Specifikacije	
34261	280 x 140 x 30 mm	1

**REZERVNI
SUNĐER**MADE IN
EU

Br.	Specifikacije	
34265	280 x 140 x 30 mm	1

**REZERVNI
SUNĐER**MADE IN
EU

Br.	Specifikacije	
34238	280 x 140 x 30 mm	1

**REZERVNI
SUNĐER**MADE IN
EU

Br.	Specifikacije	
34237	280 x 140 x 30 mm	1
34235	250 x 130 x 30 mm	1

**REZERVNA
GUMA**MADE IN
EU

Br.	Specifikacije	
34231	280 x 140 x 10 mm	1



FESTA

ELEKTRICKÉ MIECHADLO STAVEBNÝCH ZMESÍ DVOJMETĽOVÉ

Napon	1800 W
Napon	230 V / 50 Hz
Stepeni brzina	2
1. stepen (brzina bez opterećenja)	0 - 450 ot./min.
2. stepen (brzina bez opterećenja)	0 - 790 ot./min.
Zaštita protiv preopterećen	Da
Prečnik bubnja mešalice	100 mm
Dužina mešača	570 mm
Težina	5,6 kg



Br.	Specifikacije	
35311	mešalica	1
35318	rezervni ugljenik	1
35319	rezervne mešalice - par (L+R)	1



FESTA

MEŠALICA GRAĐEVINSKIH SMESA, 1600W

Ulazna snaga	1600 W
Napon	230 V / 50 Hz
Stepeni brzina	2
1. stepen (brzina bez opterećenja)	0 - 480 ot./min
2. stepen (brzina bez opterećenja)	0 - 800 ot./min.
Zaštita protiv preopterećen	Da
Navoj mešača mešalice	M14
Prečnik bubnja mešalice	140 mm
Dužina mešača	600 mm
Težina	4,7 kg

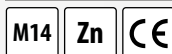

Br.	Specifikacije	
35310		1
35317	rezervni ugljenik	1



FESTA

MEŠALICA GRAĐEVINSKIH SMESA, 850W

Ulazna snaga	850 W
Napon	230 V / 50 Hz
Stepeni brzina	1
1. stepen (brzina bez opterećenja)	0 - 500 ot./min
2. stepen (brzina bez opterećenja)	-
Zaštita protiv preopterećenja	Da
Navoj mešača mešalice	M14
Prečnik bubnja mešalice	120 mm
Dužina mešača	600 mm
Težina	3,7 kg

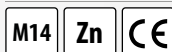

Br.	Specifikacije	
35300		1
35316	rezervni ugljenik	1



**WEST
BERG****MEŠALICA GRAĐEVINSKIH SMESA, 1600W**

Ulazna snaga	1600 W
Napon	230 V / 50 Hz
Stepeni brzina	2
1. stepen (brzina bez opterećenja)	180 - 400 ot./min.
2. stepen (brzina bez opterećenja)	300 - 700 ot./min.
Zaštita protiv preopterećenja	Da
Navoj mešača mešalice	M 14
Prečnik bubnja mešalice	140 mm
Dužina mešača	600 mm
Težina	5,4 kg

M14 Zn CE

Br.	Specifikacije	
35305		1
35315	rezervni ugljenik	1

**NEW****FESTA****PROŠIRENJE
MEŠAČA****M14**

Br.	Specifikacije	
35142	M14	1

**NEW****FESTA****MEŠAČ SPIRALNI**

Spiralna mješalica sa tri oštrice i prstenom – desna – za žitke mase korištene u više slojeva. Miješani material je pritisnut. Retka masa ne prska iz posude, pigmenti u boji se ravnomjerno i dobro izmješaju.

Zn	M14	Br.	Specifikacije		
		35085	M14 Ø 120 x 600 mm	12	
		35086	M14 Ø 140 x 600 mm	12	
		35087	M14 Ø 160 x 600 mm	12	

**FESTA****MEŠAČ SPIRALNI**

Spiralna mješalica sa tri oštrice i prstenom – lijeva – za teške materijale sa visokom viskoznošću (gustoćom), mortove, beton, cement i fasade, spojne materijale, epokomidne spojeve, bitumenska ljepila.

Zn	M14	Br.	Specifikacije		
		35091	M14 Ø 120 x 600 mm	12	
		35092	M14 Ø 140 x 600 mm	12	
		35093	M14 Ø 160 x 600 mm	12	

**FESTA****MEŠAČ SPIRALNI**

Spiralna mješalica sa dvije oštrice – za potpuno miješanje ljepila za pločice, spojnih materijala, grubih materijala, estriha, završnih materijala i glatkih smjesa.

Zn	Br.	Specifikacije	
	35038	Ø 80 x 500 mm	24
	35058	Ø 100 x 500 mm	24
	35023	Ø 120 x 500 mm	24



FESTA

MEŠAČ SPIRALNI

Spiralna mješalica sa dvije oštrice - za potpuno miješanje ljepila za pločice, spojnih materijala, grubih materijala, estriha, završnih materijala i glatkih smjesa.

SDS+	Zn	Br.	Specifikacije	
		35094	Ø 80 x 500 mm	24
		35095	Ø 100 x 500 mm	24
		35096	Ø 120 x 500 mm	24



FESTA

MEŠAČ SPIRALNI

Spiralna mješalica sa dvije oštrice - za potpuno miješanje ljepila za pločice, spojnih materijala, grubih materijala, estriha, završnih materijala i glatkih smjesa.

M14	Zn	Br.	Specifikacije	
		35059	M14 Ø 90 x 550 mm	24



FESTA

MEŠAČ SPIRALNI

Spiralna mješalica sa dvije oštrice - za potpuno miješanje ljepila za pločice, spojnih materijala, grubih materijala, estriha, završnih materijala i glatkih smjesa.

	Zn	Br.	Specifikacije	
		35013	Ø 80 x 500 mm	24
		35006	Ø 100 x 500 mm	24
		35007	Ø 120 x 500 mm	24

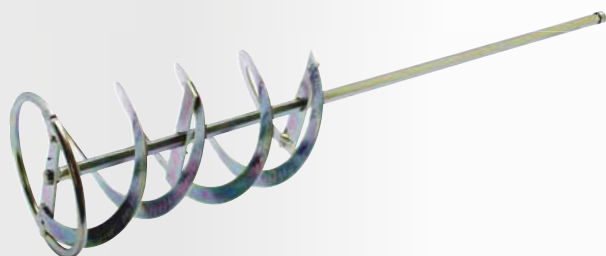

FESTA

MEŠAČ SPIRALNI

Spiralna mješalica sa dvije oštrice - za potpuno miješanje ljepila za pločice, spojnih materijala, grubih materijala, estriha, završnih materijala i glatkih smjesa.

SDS+	Zn	Br.	Specifikacije		
		35012	Ø 100 x 500 mm	24	



FESTA

MEŠAČ SPIRALNI ŽIČANI

Spiralna mješalica sa dvije oštrice - za potpuno miješanje ljepila za pločice, spojnih materijala, grubih materijala, estriha, završnih materijala i glatkih smjesa.

	Zn	Br.	Specifikacije	
		35069	Ø 60 x 500 mm	50
		35078	Ø 80 x 500 mm	24
		35081	Ø 100 x 500 mm	24



FESTA

MEŠAČ SPIRALNI ŽIČANI

Spiralna mješalica sa dvije oštrice - za potpuno miješanje ljepila za pločice, spojnih materijala, grubih materijala, estriha, završnih materijala i glatkih smjesa.

SDS+	Zn	Br.	Specifikacije	
		35070	Ø 60 x 500 mm	50
		35079	Ø 80 x 500 mm	24
		35082	Ø 100 x 500 mm	24



FESTA**MEŠAČ SPIRALNI**

Spiralna mješalica sa dvije oštrice - za potpuno miješanje ljepila za pločice, spojnih materijala, grubih materijala, estriha, završnih materijala i glatkih smjesa.

Zn	Br.	Specifikacije	24
	35048	Ø 70 x 500 mm	
	35068	Ø 90 x 500 mm	24

**FESTA****MEŠAČ SPIRALNI**

Spiralna mješalica - za potpuno miješanje ljepila za pločice, spojnih materijala, grubih materijala, estriha, završnih materijala i glatkih smjesa.

Zn	Br.	Specifikacije	24
	35021	Ø 90 x 500 mm	

**FESTA****MEŠAČ**

Mješalica za potpuno miješanje ljepila za pločice, spojnih materijala, grubih materijala, estriha, završnih materijala i glatkih smjesa.

Zn	Br.	Specifikacije	20
	35015	Ø 100 x 500 mm	

**FESTA****MEŠAČ MIKOMER**

Mješalica sa propelerom - za tekuće materijale, boje, ljepila za tapete, ljepila za pločice.

Zn	Br.	Specifikacije	50
	35011	Ø 80 x 500 mm	

**SPIRALNI MEŠAČ POCINKOVANI**

Arkadna mješalica sa prstenom - za potpuno miješanje zidnih boja, disperzivnih boja, ljepila, ljepila za podove, boja, bitumenskih, asfaltnih i ostalih premaza.

Zn	Br.	Specifikacije	40	
	35125	Ø 60 x 400 mm		40
	35126	Ø 80 x 400 mm		40
	35127	Ø 100 x 600 mm		20

**MEŠAČ LAKIRANI**

Arkadna mješalica sa prstenom - za potpuno miješanje zidnih boja, disperzivnih boja, ljepila, ljepila za podove, boja, bitumenskih, asfaltnih i ostalih premaza.

Zn	Br.	Specifikacije	40	
	35103	Ø 60 x 400 mm		40
	35113	Ø 80 x 400 mm		40
	35123	Ø 100 x 600 mm		20



FESTA



PROFESIONALNE MEŠALICE ZA BETON

Lescha

Mešalice za zahtevnu profesionalnu upotrebu
Pogonski venac napravljen od čvrstog čelika sa patentiranim učvršćivačem.

Podesivi zubi.

Vrhunska završna obrada.

Dvostruki ležaj na bubnju mešalice.

Patentirana izolaciona zaštita, kvalitetna zaštita po DIN EN ISO 900 standardu.

Specijalno dizajniran oblik bubnja.

Zaštita protiv prskanja. IP 45.

Obezbeđuje se u 230v i 400v.



Lescha
MEŠALICA



Br.	Specifikacije	
35500	Star 150 - 125 l, 230 V nožni odmor	1



Lescha
MEŠALICA



Br.	Specifikacije	
35502	EUROMIX 125 l, 230 V	1
35503	EUROMIX 125 l, 400 V	1



Lescha
MEŠALICA



Br.	Specifikacije	
35501	BX 135 - 125 l, 230 V	1



Lescha
MEŠALICA



Br.	Specifikacije	
35504	ABM 135 l, 230 V nožni odmor	1



Lescha
MEŠALICA



Br.	Specifikacije	
35505	SM 145 S - 140 l, 230 V	1
35506	SM 145 S - 140 l, 400 V	1
35507	SM 145 S - 140 l, 230 V nožni odmor	1
35508	SM 145 S - 140 l, 400 V nožni odmor	1



Lescha
MEŠALICA



Br.	Specifikacije	
35510	SM 165 S - 160 l, 230 V nožni odmor	1
35511	SM 165 S - 160 l, 400 V nožni odmor	1
35512	SM 165 S - 160 l, G benzinska	1



Lescha
MEŠALICA



Br.	Specifikacije	
35514	SM 185 S - 180 l, 230 V nožni odmor	1
35515	SM 185 S - 180 l, 400 V nožni odmor	1



Lescha
MEŠALICA



Br.	Specifikacije	
35516	S 180 HR - 180 l, 230 V nožni odmor	1
35517	S 180 HR - 180 l, 400 V nožni odmor	1



Lescha
MEŠALICA



Br.	Specifikacije	
35524	LB 354 230 V, 1,5 kW	1
35525	LB 354 400 V, 1,5 kW	1
35527	LB 354 Honda G200	1
35532	LB 404 230 V, 1,5 kW	1
35533	LB 404 400 V, 1,5 kW	1
35539	LB 484 Robin EH17B	1
35540	LB 484 Honda GX160LX	1
35542	AT 480 400 V, 1,2 kW	1

Lescha
MEŠALICA



Br.	Specifikacije	
35518	S 230 HR - 230 l, 230 V nožni odmor	1
35519	S 230 HR - 230 l, 400 V nožni odmor	1

Lescha
MEŠALICA



Br.	Specifikacije	
35552	LHB 1000 400 V	1
35553	LHB 1000 HATZ Diesel	1
35555	LHB 1200 400 V	1



ALTRAD
SPROMASZ

MEŠALICA



Br.	Specifikacije	
37500	MIX 130Zk 230 V unassembled	1
37501	MIX 130Z 230 V assembled	1
37505	MK 165Bk 230 V unassembled	1
37506	MK 165B 230 V assembled	1

130 L

Specifikacije	
volume of drum	130 l
drum speed	26±Min ⁻¹
power	700 W
voltage	230 V / 50 Hz
degree of protection	IP44
material of chaplet	Litinový
dimensions	Dužina 1170 mm Širina 650 mm Visina 1280 mm
weight	53 kg

165 L

Specifikacije	
volume of drum	165 l
drum speed	23±Min ⁻¹
power	900 W
voltage	230 V / 50 Hz
degree of protection	IP44
material of chaplet	Litinový
dimensions	Dužina 1295 mm Širina 735 mm Visina 1440 mm
weight	70 kg

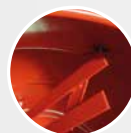

· specially made shoulder-blade 4 mm



· good quality thrust bearing



· switch with safety shield



· plastic shield of drive, cast iron wreath

MEŠALICA



125 L

Specifikacije	
volume of drum	125 l
drum speed	26±Min ⁻¹
power	550 W
voltage	230 V / 50 Hz
degree of protection	IP44
material of chaplet	Litinový
dimensions	Dužina 1102 mm
	Širina 690 mm
	Visina 1310 mm
weight	52,5 kg

Br.	Specifikacije		
37509	126 l, 230 V	assembled	1
37510	126 l, 230 V	unassembled	1

162 L

Specifikacije	
volume of drum	162 l
drum speed	26±Min ⁻¹
power	650 W
voltage	230 V / 50 Hz
degree of protection	IP44
material of chaplet	Litinový
dimensions	Dužina 1180 mm
	Širina 710 mm
	Visina 1310 mm
weight	56 kg

Br.	Specifikacije		
37515	162 l, 230 V	unassembled	1
37516	162 l, 230 V	assembled	1

142 L

Specifikacije	
volume of drum	142 l
drum speed	26±Min ⁻¹
power	650 W
voltage	230 V / 50 Hz
degree of protection	IP44
material of chaplet	Litinový
dimensions	Dužina 1164 mm
	Širina 690 mm
	Visina 1293 mm
weight	54 kg

Br.	Specifikacije		
37511	142 l, 230 V	unassembled	1
37512	142 l, 230 V	assembled	1

180 L

Specifikacije	
volume of drum	180 l
drum speed	26±Min ⁻¹
power	850 W
voltage	230 V / 50 Hz
degree of protection	IP44
material of chaplet	Litinový
dimensions	Dužina 1164 mm
	Širina 690 mm
	Visina 1368 mm
weight	58 kg

Br.	Specifikacije		
37517	180 l, 230 V	unassembled	1
37518	180 l, 230 V	assembled	1



GRAĐEVINSKA KOLICA - TAČKE



Br.	Specifikacije		
37530	60 l, Ø 38 cm	Točak bez naduvavanja	1
37532	60 l, Ø 40 cm	Točak za naduvavanje	1



GRAĐEVINSKA POCINKOVANA KOLICA - TAČKE



Br.	Specifikacije		
37527	80 l, Ø 40 cm	Točak za naduvavanje	1
37533	80 l, Ø 38 cm	Točak bez naduvavanja	1

REZERVNO
KORITO
ZA KOLICA

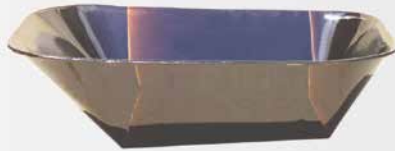

Br.	Specifikacije	
37539	60 l	1

REZERVNO
KORITO
POCINKOVANO



Br.	Specifikacije	
37541	80 l	1

REZERVNI TOČKOVI
ZA KOLICA



Br.	Specifikacije	
48729	typ AA 400	Točak za naduvavanje 1
48730	typ AA 380	Točak bez naduvavanja 1
48731	typ AA 380	Točak bez naduvavanja 1

GRAĐEVINSKA
KOLICA - TAČKE
SA TRI TOČKA



Br.	Specifikacije	
37564	60 l	1

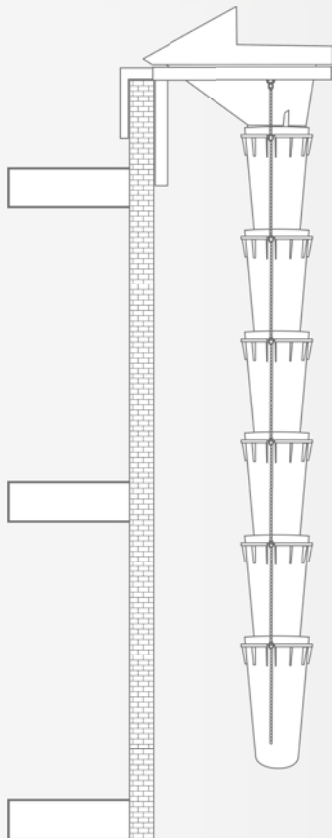

Lescha

PUNILAC GRADJEVINSKIM OTPADOM



Br.	Specifikacije	
35603	zhoz základný priemer 50/40 cm, dĺžka 108 cm PE (HDPE)	1
35604	násypka zhodu stavebnej sutiny PE (HDPE)	1
35605	nosný rám pre násypku zhodu stavebnej sutiny	1

HORIZONT®



HORIZONT®

LETVA ZIDARSKA

ALU

Br.	Specifikacija	
15310	100 cm	10
15315	150 cm	10
15318	180 cm	10
15320	200 cm	10
15325	250 cm	10
15330	300 cm	10
15335	350 cm	10
15340	400 cm	10



HORIZONT®

LETVA ZIDARSKA SA LIBELOM

ALU

Br.	Specifikacija	
15415	150 cm	10
15418	180 cm	10
15420	200 cm	10
15425	250 cm	10
15430	300 cm	10



HORIZONT®

LETVA ZIDARSKA SA LIBELOM 1/2

ALU

Br.	Specifikacija	
15510	100 cm	10
15515	150 cm	10
15518	180 cm	10
15520	200 cm	10
15525	250 cm	10
15530	300 cm	10
15535	350 cm	10
15540	400 cm	5



HORIZONT®

LETVA ZIDARSKA SA 2 RUKOHVATA

ALU

Br.	Specifikacija	
15615	150 cm	10
15620	200 cm	10
15625	250 cm	10
15630	300 cm	10



HORIZONT®

LETVA ZIDARSKA SA 2 RUKOHVATA + 2 LIBELE

ALU

Br.	Specifikacija	
15710	100 cm	10
15715	150 cm	10
15720	200 cm	10
15725	250 cm	10
15730	300 cm	10
15735	350 cm	10
15740	400 cm	5





HORIZONT
LETVA ZIDARSKA TRAPEZ

PROFILE TRAPEZOIDAL
· trapezoidal profile for finishing surface and niches
· suitable for stucco and facades
· suitable for thin-film plasters

ALU	Br.	Specifikacija	
	15810	100 cm	10
	15812	120 cm	10
	15815	150 cm	10
	15818	180 cm	10
	15820	200 cm	10
	15825	250 cm	10
	15830	300 cm	10



HORIZONT
LETVA ZIDARSKA „h“ PROFIL

PROFILE "h"
· "h" profile for finishing surface and niches
· suitable for stucco and facades
· suitable for stucco plastering

ALU	Br.	Specifikacija	
	15850	100 cm	10
	15853	150 cm	10
	15855	180 cm	10
	15860	200 cm	10
	15870	250 cm	10
	15880	300 cm	10



NEW

HORIZONT
KVAČILO
ZA ZIDARSKÉ LETVE
HORIZONT

Br.	Specifikacija		
15301		1	



HORIZONT
LETVA ZIDARSKA SA LIBELOM
PODESIVA

Br.	Specifikacija		
15893	65 - 100 cm	1	
15894	95 - 150 cm	1	
15895	145 - 235 cm	1	



HORIZONT
UGAONIK

ALU	Br.	Specifikacija	
	14485	800 x 1200 mm	1
	14486	1000 x 1500 mm	1



**FESTA**

SAVIJAČ ŠTAPA



Br.	Specifikacije	
26730	Ø 6 - 14 mm	1
26731	Ø 5 - 8 mm	1

**NEW****FESTA**

DRŽAČ ZA CIGLE



Br.	Specifikacije	
60130	27 - 45 cm	10

NEW**FESTA**

DRŽAČ ZA CIGLE



Br.	Specifikacije	
60132		1

NEW**FESTA**

KOLIČA ZA IVIČNJAK

· max 150 kg



Br.	Specifikacije	
60157		1



SAVIJAČ ŠTAPA

Br.	Specifikacije	
26735	max Ø 13 mm 56 cm	1

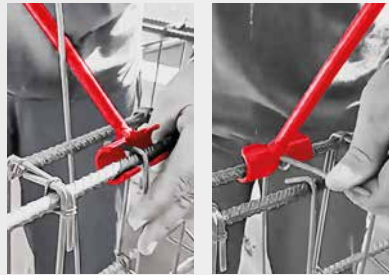
**NEW**

SAVIJAČ ŠTAPA

· Ø 4-8 mm

Br.	Specifikacije	
26736		1

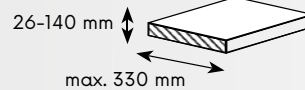
NEW**FESTA**

REZAČ PLOČICA

· max 45 kg

Br.	Specifikacije	
60125		1

**NEW****FESTA**

KOLIČA ZA IVIČNJAK

· max 100 kg



Br.	Specifikacije	
60155		1



30 - 50 cm

DRŽAČ ZA CIGLE

Br.	Specifikacije	
36310	max. 20kg	5



DRŽAČ IVIČNJAKA

Specifikacije	60116
Dimenzija ivičnjaka	750-1000 mm
Max.	120 kg

Br.	Specifikacije	
60116	PRO 041	1



ČEKIČ

Specifikacije	60121	60123
Visina	200 mm	200 mm
Širina	70 kg	70 kg
Dužina	870 mm	450 mm
Težina	2,5 kg	2,2 kg

Br.	Specifikacije	
60121	870 mm	1
60123	450 mm	1



DRŽAČ IVIČNJAKA

Specifikacije	60115
Dimenzija ivičnjaka	80-370 mm
Max.	50 kg

Br.	Specifikacije	
60115	PRO 040	1



DRŽAČ IVIČNJAKA

Specifikacije	60117	60118
Dimenzija ivičnjaka	500-1000 mm	0-500 mm
Max.	150 kg	150 kg

Br.	Specifikacije	
60117	PRO 042	1
60118	PRO 043	1



PODMETAČ

Br.	Specifikacije	
37166	D10 osnovni	25



KOTURAČA ZA POD. TERETA SA KUKOM

Br.	Specifikacije	
26780	0,5 t A with hook	1
26781	0,5 t B with eye	1
26782	0,5 t C with hook, with cover	1
26783	0,5 t D with eye, with cover	1

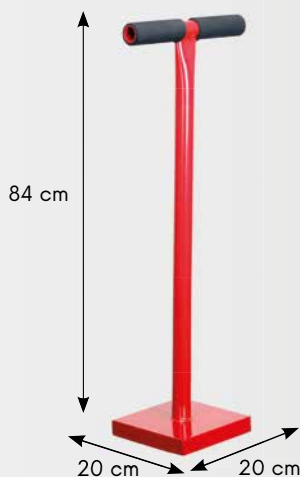

RUČNI NABIJAČ

Br.	Specifikacije	
26740	12 kg	1



RUČNA KOLICA ZA PRENOŠENJE TERETA

Br.	Specifikacije	nosnost	
48719	kolo 260 mm bantam	250 kg	1



PROFESIONALNI REZAČI PLOČICA

- Rezač pločica za najzahtevnije PROFI korištenje
- Klizanje je rešeno sa devet kugličnih ležajeva SKF, a četiri se daju podešavati
- Amortizirajući stol
- Rezač se može postaviti za rad sa lijevom rukom
- Osigurani rezervni dijelovi i servis
- Rezni točkići od hrom-wolfram čelika

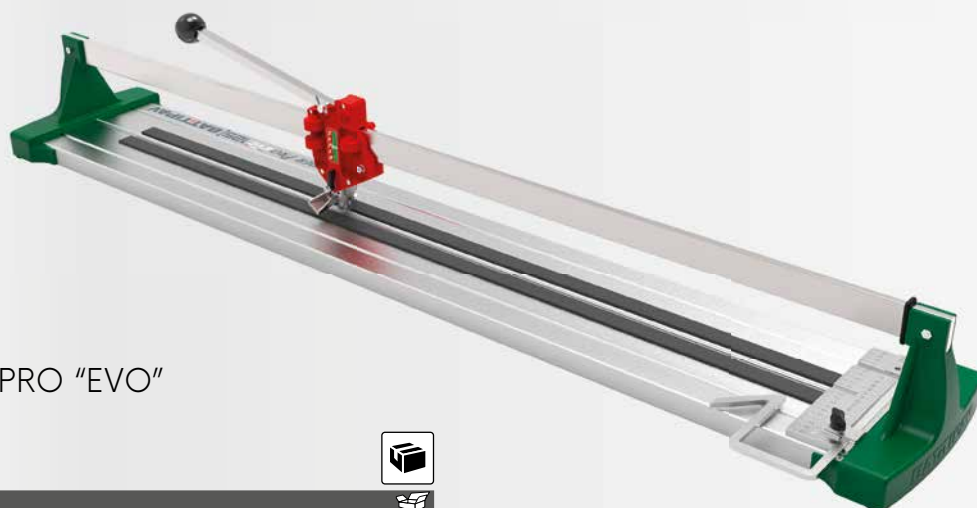

SUPER PRO



REZAČ PLOČICA SUPER PRO "EVO"

• 36195 Rezervni rezni točkić - Ø 22 mm



Br.	Specifikacije
36191	1250 mm

SUPER PRO



REZAČ PLOČICA SUPER PRO

• 36195 Rezervni rezni točkić - Ø 22 mm



Br.	Specifikacije
36145	SUPER PRO 450 mm
36160	SUPER PRO 600 mm
36175	SUPER PRO 750 mm
36190	SUPER PRO 900 mm



• Ilustracija fotografija

POLICA REKLAMNA SUPER PRO



Br.	Specifikacije
36200	Stalak
36199	Stalak za 36160, 36175, 36190



FESTA

REZAČ PLOČICA „X“

· 36138 Rezervni rezni točkić - Ø 22 mm



Br.	Specifikacije	
36085	600 mm	1
36087	900 mm	1
36086	1300 mm	1



NEW



FESTA

REZAČ PLOČICA

· 36139 Rezervni rezni točkić - Ø 22 mm



Br.	Specifikacije	
36102	1050 mm	1
36103	1300 mm	1
36105	1550 mm	1

FESTA

REZAČ PLOČICA

· 36195 Rezervni rezni točkić - Ø 22 mm



Br.	Specifikacije	
36080	600 mm	1
36081	750 mm	1
36082	900 mm	1
36076	750 mm assembled	1
36077	900 mm assembled	1



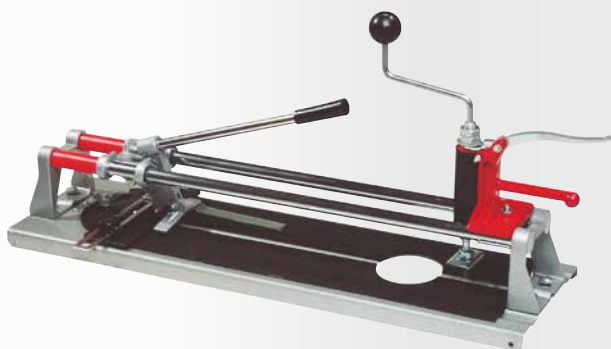

REZAČ PLOČICA

• 36128 Rezervni rezni točkić - Ø 16 mm



Br.	Specifikacije	
36014	480 mm	4

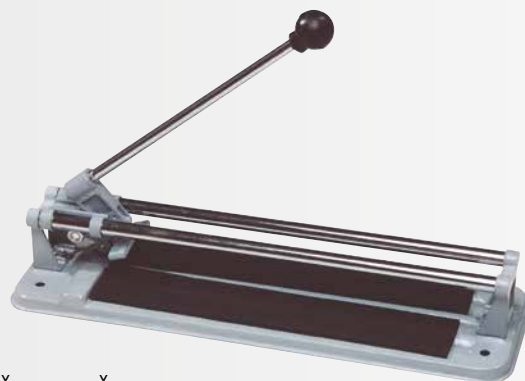

REZAČ PLOČICA

• 36126 Rezervni rezni točkić - Ø 15 mm



Br.	Specifikacije	
36024	300 mm	10
36034	400 mm	10
36035	600 mm	4



REZAČ PLOČICA

• 36136 Rezervni rezni točkić - Ø 22 mm



Br.	Specifikacije	
36036	480 mm	1



REZAČ PLOČICA RUČNI

• 36136 Rezervni rezni točkić - Ø 22,2 mm



Br.	Specifikacije	
36046	22 mm	1

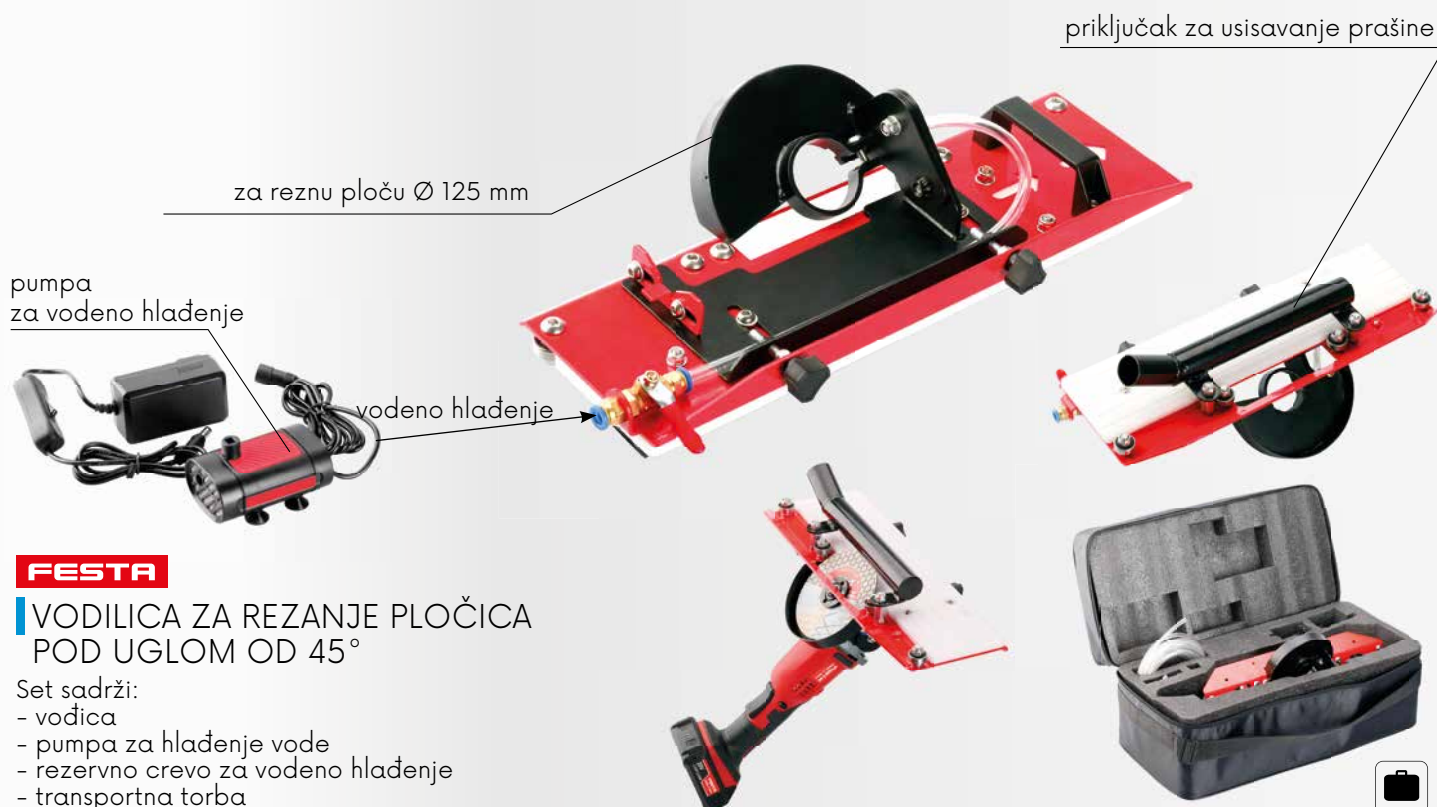

FESTA

VODILICA ZA REZANJE PLOČICA POD UGLJOM OD 45°

Set sadrži:

- vođica
- pumpa za hlađenje vode
- rezervno crevo za vodeno hlađenje
- transportna torba

Br.	Specifikacije	
24680		1

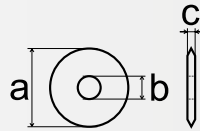

REZERVNI TOČKIĆ ZA REZAČ PLOČICA



Broj	specifikacija	
36126	a= Ø 15 mm, b= Ø 6 mm, c= 1,5 mm	1
36128	a= Ø 16 mm, b= Ø 6 mm, c= 3 mm	1
36130	a= Ø 20 mm, b= Ø 6 mm, c= 5 mm	1
36136	a= Ø 22 mm, b= Ø 6 mm, c= 2 mm	1
36138	a= Ø 22 mm, b= Ø 6 mm, c= 5 mm	1
36139	a= Ø 22 mm, b= Ø 6 mm, c= 6 mm	1
36195	a= Ø 22 mm, b= Ø 6 mm, c= 4,8 mm	1



TESTERA ZA PLOČICE

Br.	Specifikacije	
24055	Karbid - BOSCH, MAKITA	1



KLJEŠTA ZA PLOČICE



Br.	Specifikacije	
36056		10



FESTA

KLJEŠTA ZA PLOČICE



Br.	Specifikacije	
36057	200 mm	6



KLJEŠTA ZA PLOČICE



Br.	Specifikacije	
36059		1



KLJEŠTA ZA PLOČICE PAPAGAJ



Br.	Specifikacije	
36058	200 mm	6



FESTA

SEKAČ ZA LAMINAT I VINIL



Br.	Specifikacije	
36140	210 mm	4



NEW



FESTA

GLADILICA ZA SILIKON



Br.	Specifikacije
37050	

1

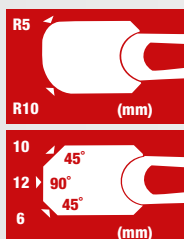

FESTA

GLADILICA ZA SILIKON



Br.	Specifikacije
16056	145 mm

50

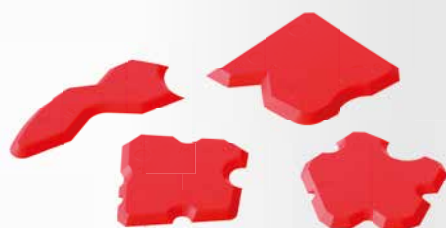

GLADILICA ZA SILIKON

4x



Br.	Specifikacije
37052	

1



GLADILICA ZA SILIKON

4x



Br.	Specifikacije
37053	

48



GLADILICA ZA SILIKON

Br.	Specifikacije
37054	

1



GLADILICA ZA SILIKON

· Za brtvljenje prozora

Br.	Specifikacije
37055	

1

GLADILICA DRVENA
SA GUMOM

Br.	Specifikacije
37011	180 mm
37021	280 mm

12

12



37028



37029



37025



37026

SUNĐER MEKI KOCKASTI 160 X 110 X 60 MM

Br.	Specifikacije
37028	hidro sundjer
37029	Morski sundjer

1

1

SUNĐER MEKI KOCKASTI 200 X 100 X 100 MM

Br.	Specifikacije
37025	Fina
37026	Morski sundjer

1

1

KANTA ZA PRANJE
PAHUKA

Br.	Specifikacije
37117	Komplet
90070	Kanta 25 l

1

1

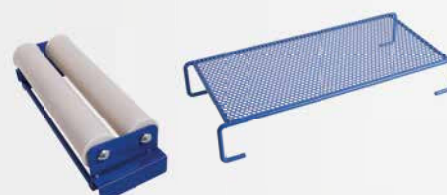

KANTA ZA PRANJE - PRIBOR

Br.	Specifikacije
90072	Rešetka
90071	Metalni valjci

1

1



UGAONI ČISTAČ

Br.	Specifikacije	
37012		1



UGAONI ČISTAČ

Br.	Specifikacije	
37006	30 mm	20
37007	50 mm	20
37008	Rezervni nož 30 mm	50
37009	Rezervni nož 50 mm	50



SET ČISTAČA ZA SILIKON

Br.	Specifikacije	
16042		12

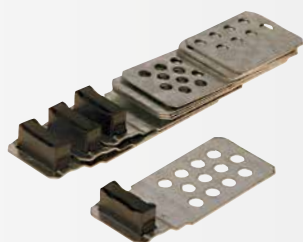

MAGNET ZA VRATANCA

Br.	Specifikacije	
38920		1



MAGNET POMIČNI ZA VRATANCA

Br.	Specifikacije	
38923		24



UGAONI GRADJEVINSKI

Br.	Specifikacije	
38919		50



PIŠTOLJ ZA INJEKTIRANJE

· obim 1,5 l

Br.	Specifikacije	
38026	5x vrh	25



KESA ZA FUGOVANJE



Br.	Specifikacije	
38042	3x vrh	6

NEW

- Ø 10 mm
- Ø 14 mm
- Ø 20 mm
- Ø 10 x 35 mm

FESTA
APLIKATOR



Br.	Specifikacije	
38045		1



KOMPLET ZA POSTAVLJANJE LAMINATA

24x	Br.	52130	1
	1		

KLIN

50x

Br.	Specifikacije	Kom	1
37210	95 x 45 x 15 - 0 mm	50	1
37211	70 x 30 x 8 - 0 mm	50	1



VAZDUŠNI JASTUK ZA MONTAŽU

· Dimenzija
· MaKom. visina

Br.	37220	1
1		

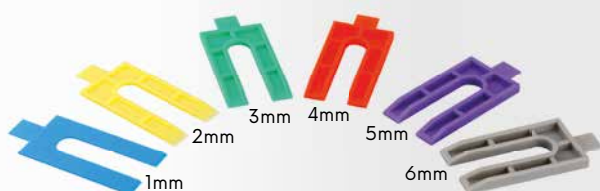

ODSTOJNICI

30x

Br.	37212	1 - 6 mm, 5x bilo koje veličine	1
1			

FESTA

KLIN



Br.	Specifikacije	Kom	1
37204	55 x 20 x 0 - 6 mm	20	1
37203	65 x 18 x 0 - 12 mm	20	1
37202	80 x 25 x 3 - 10 mm	20	1
37201	100 x 25 x 1 - 16 mm	14	1
37200	150 x 25 x 1 - 25 mm	8	1



FESTA

KAJLICE ZA PLOČICE PVC

Br.	Specifikacije	Kom	100
37155	0 - 8 mm	30	100
37156	0 - 4 mm	100	100
37157	2,5 - 8 mm	30	100



FESTA

KAJLICE ZA PLOČICE

250x

Br.	37205	55 x 8 x 0 - 10 mm	250	1
1				



NEW



NIVELYS
LEVELING SYSTEM **FESTA**

TEMELJNI PROFIL ISPOD PLOČICE

ALU

Br.	Specifikacije	1
37105	50 cm	1
37106	100 cm	1
37107	150 cm	1



NEW

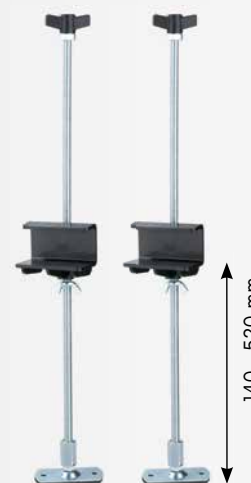

NIVELYS
LEVELING SYSTEM **FESTA**

PODESIVO POSTOLJE ZA PROFIL FONDACIJE

· max. 50 kg

2x

Br.	37102	1
1		

NIVELYS

LEVELING SYSTEMS

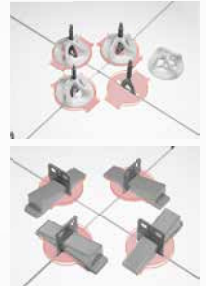

NIVELYS LEVELING SYSTEMS FESTA

NAVOJNI ODSOJNI KLIP

50x

Br.	Specifikacije	Kom
37131	1 mm	40
37132	2 mm	40

NIVELYS LEVELING SYSTEMS FESTA

ŠEŠIR ZA IZRAVNAVANJE SA KONCEM

50x

Br.	Specifikacije	Kom
37130		15

NIVELYS LEVELING SYSTEMS FESTA

ZAŠTITNE PLOČE ZA SISTEME NIVELACIJE PLOČICA

100x

Br.	Specifikacije	Kom
37192		1

NIVELYS LEVELING SYSTEMS FESTA

SPONE – DISTANCERI

kajle za nivelaciju 37175, 37176

50x

Br.	Specifikacije	Kom
37170	1 mm	50
37171	2 mm	50
37172	3 mm	50

NIVELYS LEVELING SYSTEMS FESTA

SPONE – DISTANCERI

100x

Br.	Specifikacije	Kom
37185	1 mm	100
37190	1,5 mm	100
37186	2 mm	100

Br.	Specifikacije	Kom
37187	3 mm	100
37188	4 mm	100
37189	5 mm	100

NIVELYS LEVELING SYSTEMS FESTA

SPONE – DISTANCERI

100x

Br.	Specifikacije	Kom
37162	1,5 mm	1

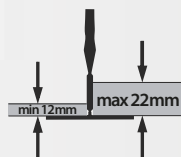

NIVELYS LEVELING SYSTEMS FESTA

KAJLE ZA NIVELACIJU

Br.	Specifikacije	Kom
37175		50
37176		400

NIVELYS LEVELING SYSTEMS FESTA

NIVELYS
LEVELING SYSTEMS **FESTA**

SPONE – DISTANCERI

600x

Br.	Specifikacije	Kom	krabice	
37125	1 mm	600	38 x 28 x 19 cm	1
37126	1,5 mm	600	38 x 28 x 19 cm	1
37127	2 mm	600	38 x 28 x 19 cm	1



NIVELYS
LEVELING SYSTEMS **FESTA**

SPONE – DISTANCERI + KAJLE ZA NIVELACIJU

Br.	Specifikacije	
37173	1 mm, 400 Kom + 200 Kom	1
37174	1,5 mm, 400 Kom + 200 Kom	1

NIVELYS
LEVELING SYSTEMS **FESTA**

KLEŠTA ZA NIVELACIJU

Br.	
37177	1

NIVELYS
LEVELING SYSTEMS **FESTA**

KLEŠTA ZA NIVELACIJU

Br.	
37178	1

NIVELAČNÍ KLIP SADA

50x

Br.	Specifikacije Specification	
37199	1,5 mm	40



NIVELYS
LEVELING SYSTEMS **FESTA**

KRSTIČI ZA PLOČICE

100x

Br.	Specifikacije	Kom	
37195	1,0 mm	100	12
37196	1,5 mm	100	12
37197	2 mm	100	12
37198	3 mm	100	12

FESTA

KRSTIČI ZA PLOČICE

Br.	Specifikacije	Kom	
37148	1,0 mm	200	100
37149	1,5 mm	200	100
37150	2 mm	200	100
37151	2,5 mm	200	100
37152	3 mm	150	100
37153	4 mm	100	100
37154	5 mm	75	100
37158	10 mm	30	100

FESTA

KRSTIČI ZA PLOČICE

Br.	Specifikacije	
37285	1,5 mm	100
37286	2 mm	100
37287	2,5 mm	100
37288	3 mm	100
37289	4 mm	100

NEW

horizontalni položaj
110 kg
Ø 220 mm
vertikalni položaj
80 kg
USB-C

FESTA
POWER X TOOLS

USISNA ČAŠA AKU

Ø 220 mm	80kg	110kg	ROUGH SURFACE	USB-C	Li-ion 3.6V 2Ah
----------	------	-------	---------------	-------	--------------------

Br. specifikacija

36326

USB - C



1

FESTA

DRŽAČ PLOČICA SA INDIKATOROM VAKUUMA

Ø 200 mm	140kg	100kg	ROUGH SURFACE
----------	-------	-------	---------------

Br. Specifikacije

36325



1

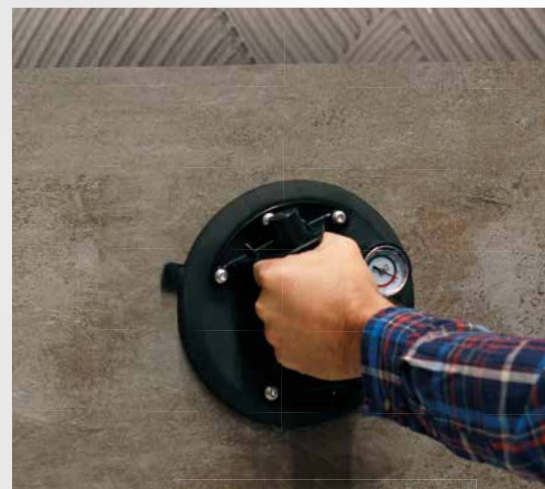

FESTA

DRŽAČ STAKLA

Položaj	Nosivost
Horizontalni položaj	120 kg
Vertikalni položaj	150 kg

ALU

Br. Specifikacija

36318

Triple



10



DRŽAČ STAKLA

Br.	Specifikacija	60
36305	Jednodelni	



FESTA

DRŽAČ STAKLA

Položaj	Nosivost
Horizontalni položaj	80 kg
Vertikalni položaj	100 kg

ALU

Br. Specifikacija

36313

Dupli



20



DRŽAČ STAKLA

Br.	Specifikacija	20
36306	Dupli	



20



FESTA

DRŽAČ STAKLA

Položaj	Nosivost
Horizontalni položaj	50 kg
Vertikalni položaj	50 kg

ALU

Br. Specifikacija

36314

Jednodelni



20



DRŽAČ STAKLA

Položaj	Nosivost
Horizontalni položaj	80 kg
Vertikalni položaj	100 kg

Br.

Specifikacija

36319

Triple

10



**FESTA**

NOSAČ ZID. KANAPA 30 M SA PUDEROM 120 G

- 6x brži mehanizam za namotavanje
- Funkcija visak



Br.

37070



6

**FESTA**

NOSAČ ZID.KANAPA 30 M + PUDEROM 150 G

- 5x brži mehanizam za namotavanje



Br.

37065



6



NOSAČ ZID. KANAPA ABS 30 SA PUDEROM 180 G



Br.

37069



10



NOSAČ ZID.KANAPA 30M



Br.

37066



25



NOSAČ ZID.KANAPA 30M

ALU

Br.

37068



25



NOSAČ ZID. KANAPA ABS 30M



Br.

37067



25

**FESTA**

PUDER ZA OCRTAVANJE 180 G

Br.	Specifikacije	
37096	Plavi	10
37094	Svetlo plavi	10
37097	Crveni	10
37095	Svetlo crveni	10
37098	Crn	10

**FESTA**

KANAP ZIDARSKI CRVENI



Br.

38895 50 m

38896 100 m



24

**FESTA**

KANAP ZIDARSKI ŽUTI



Br.

38899 50 m

38900 100 m



24

**FESTA**

KANAP ZIDARSKI POLYETYLEN 50 M

Br.

38907 Crveni 1,0 mm

38908 Crveni 1,7 mm

38909 Crveni 2,0 mm

Specifikacije

100

100

100



FESTA

**KANAP ZIDARSKI
POLYETYLEN 50 M**

Br.	Specifikacije	
38904	Žuti 1,0 mm	100
38905	Žuti 1,7 mm	100
38906	Žuti 2,0 mm	100



FESTA

**KANAP ZIDARSKI
POLYETYLEN 50 M**

Br.	Specifikacije	
38910	Narandžasti 1,0 mm	100
38911	Narandžasti 1,7 mm	100
38912	Narandžasti 2,0 mm	100



FESTA

**KANAP ZIDARSKI
POLYETYLEN 50 M**

Br.	Specifikacije	
38901	Beli 1,0 mm	100
38902	Beli 1,7 mm	100
38903	Beli 2,0 mm	100



KANAP



Br.	Dužina	Ø	
50920	50 m	1 mm	80



FESTA

VISAK SA KANAPOM 15 M

Br.	Specifikacije	
38916	150 g	10
38917	300 g	6
38918	500 g	5

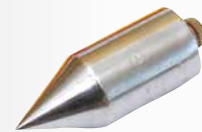

FESTA

VISAK

Br.	Specifikacije	
38913	150 g	10
38914	300 g	10
38915	500 g	10

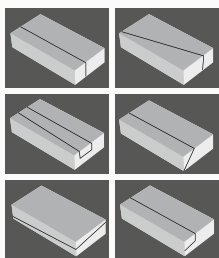

**FESTA****REZAČ STIROPORA**

- Voltaža 230 V/50 Hz
- Potrošnja struje 200 W
- Dužina reza 137 cm
- Visina reza 30 cm
- Zaštita IP44
- Ugao rezanja 0° - 90°

· oprema: postolje, nožni prekidač, držač za skele, 2k Ni-Cr žica za sečenje, mesingana četka za čišćenje, alati i pričvršćivači, plastična kutija sa točkovima



Br. Specifikacije

35348

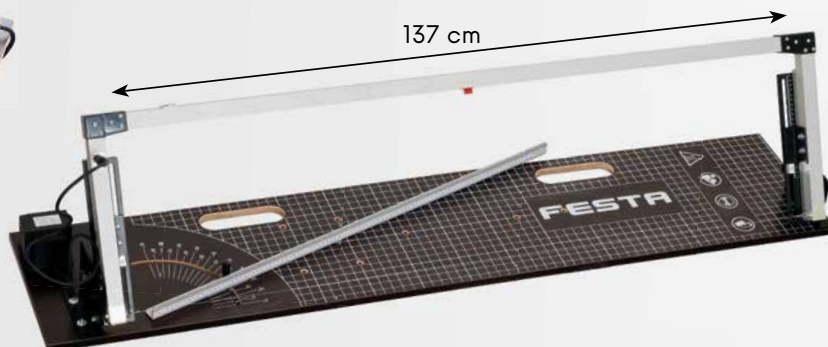
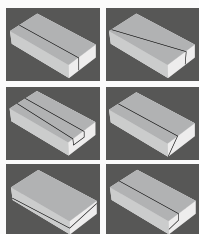

1

**FESTA****REZAČ STIROPORA**

- Voltaža 230 V / 50 Hz
- Potrošnja struje 200 W
- Dužina reza 137 cm
- Visina reza 30 cm
- Zaštita IP44
- Ugao rezanja 0° - 90°

· Oprema: Ni-Cr žica za sečenje, čišćenje četke od mesinga, imbus



Br. Specifikacije

35345



1



max. 52 cm

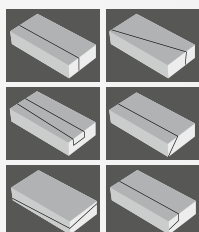

137 cm

FESTA

REZAČ STIROPORA

- Voltaža 230 V / 50 Hz
- Potrošnja struje 160 W
- Dužina reza 120 cm
- Visina reza 52 cm
- Zaštita IP44
- Ugao rezanja 0° - 90°



· Oprema: Ni-Cr žica za sečenje, čišćenje četke od mesinga, imbus

Br. Specifikacije
35344



1

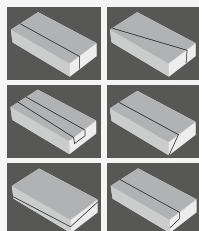

FESTA

REZAČ STIROPORA

- Voltaža 230 V / 50 Hz
- Potrošnja struje 160 W
- Dužina reza 120 cm
- Visina reza 50 cm
- Zaštita IP44
- Ugao rezanja 0° - 90°



· Oprema: Ni-Cr žica za sečenje, čišćenje četke od mesinga, imbus

Br. Specifikacije
35330



117 cm



1

**FESTA**

NOŽNI PREKIDAČ ZA REZAČ POLISTIRENA

za 35330, 35345, 35348



Br. Specifikacije

35334

1

**FESTA**

STAJATI ZA REZAČ POLISTIRENA

za 35330, 35345, 35348



Br. Specifikacije

35336

1

**FESTA**

ZAMENA OPRUGE ZA REZAČ POLISTIRENA

za 35330, 35345, 35348



Br. Specifikacije

35332

1

**FESTA**

DRŽAČ ZA SKELE ZA REZAČ POLISTIRENA

za 35330, 35345, 35348



Br. Specifikacije

35333

1

**FESTA**

REZERVNI ADAPTER ZA NAPAJANJE ZA REZAČ POLISTIRENA

za 35330, 35345, 35348



Voltaža 230 V / 50Hz

output: 36 V / 5 A

Potrošnja struje 200 W



Br. Specifikacije

35347

1

OTPORNA ŽICA Ni-Cr ZA REZAČ POLISTIRENA

Br. Specifikacije
35331 za rezač 117 cm
35346 za rezač 137 cm

1





FESTA

REZAČ ZA POLISTIRENSKE, BATERIJE

- baterija 36 V, 1,5Ah Li-ion
- potrošnja struje 180 W
- temperature max 350 C°
- dužina rezu 20 cm
- oprema: 2 baterije, punjač, sečivo, mesing četka za čišćenje, šesterokut



Br.	Specifikacija	
35323	Električni rezač stiropora	1
35328	Rezervni nož za rezač stiropora 14 cm	1
35329	Rezervni nož za rezač stiropora 25 cm	1

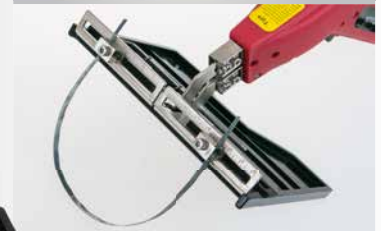

FESTA

ELEKTRIČNI REZAČ STIROPORA

- Voltaža 230 V/50 Hz
- Potrošnja struje 250 W
- Temperature 50-600 C°
- Dužina rezu 25 cm
- Dužina kabla za napajanje 3 m



· Oprema: čišćenje četke od mesinga, imbus, nož 25 a 30 cm

Br.	Specifikacija	
35326	Električni rezač stiropora	1
35328	Rezervni nož za rezač stiropora 14 cm	1
35329	Rezervni nož za rezač stiropora 25 cm	1



VODJICA ZA REZANJE STIROPORA



Br.	Specifikacija	
35327	Vodilica za rezanje polistirena	1
35335	Rezervni nož - 30 cm	1

FESTA

ELEKTRIČNI REZAČ STIROPORA



· Regulacija temperature

Br.	Specifikacija	
35325	220 W	1



FESTAGLODALICA
ZA STIROPOR

ALU

Br.	Specifikacije	
24752	Ø 65 mm	1
24753	Ø 70 mm	1



GLODALICA ZA STIROPOR

Br.	Specifikacije	
24727	Ø 65 mm	1
24729	Ø 68 mm	1
24728	Ø 70 mm	1



TIPLI ZA FASAD

100x

MADE IN
EU

Br.	Specifikacije		Br.	Specifikacije	
39210	Ø 10 x 100 mm	1	39218	Ø 10 x 180 mm	1
39212	Ø 10 x 120 mm	1	39217	Ø 10 x 200 mm	1
39214	Ø 10 x 140 mm	1	39219	Ø 10 x 220 mm	1
39216	Ø 10 x 160 mm	1			

**FESTA**TIPLA U IZOLACIJU ZA
ČAURE ZA OLOVNE ZAVRTNJE

2x

Br.	Specifikacije	
39240	beo	M10
39241	šiva	M10
39242	antracit	M10
39243	Brown	M10
39244	crn	M10

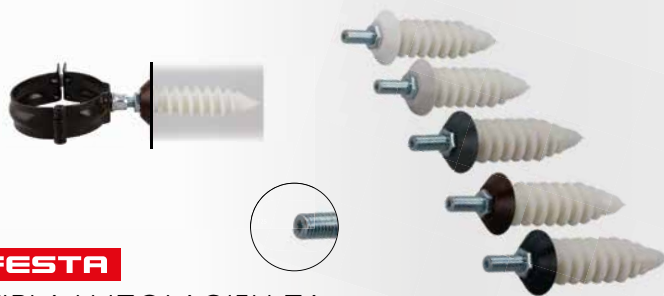

TIPLI ZA STIROPOR

za zavrtnje Ø 6 i 8 mm

50x

Br.	Specifikacije	
39208	Ø 68 mm	1

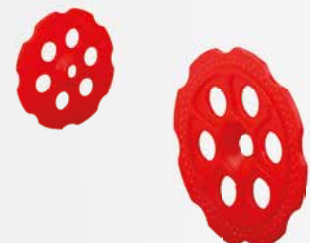

TIPLI ZA STIROPOR

Br.	Specifikacije	
39206	Ø 40 mm	200
39207	Ø 60 mm	100

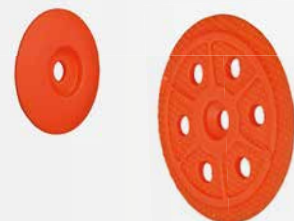

MOQ

VALJAK

MADE IN
EU

Br.	Prečnika	Visina vrha	Dužina	
38950	Ø 69 mm	12 mm	25 cm	10
38951	Ø 69 mm	12 mm	40 cm	8
38952	Ø 122 mm	34 mm	25 mm	10
38953	Ø 122 mm	34 mm	40 cm	8
38954	Ø 122 mm	34 mm	60 mm	4

PEDALE
SA ŠILJCIMAMADE IN
EU

Br.	Specifikacije	
38970	šiljci 25 mm	1
38971	šiljci 30 mm	1





TIPLI ZA RABICO



Br.	Specifikacije	
42420	Ø 30 mm	1



PLETIVO RABICO



Br.	Specifikacije	
42312	1 m 50 bm 16 x 16 mm	1

DRVENI KOŠULJICA



Br.	Dužina	Debljina	Širina	
37120	200 mm	1,7 mm	20 mm	10
37119	250 mm	1,7 mm	20 mm	10



SITO ZA PESAK



Br.	Širina	Visina	Oko sito	
37216	50 mm	50 mm	2 mm	1
37217	50 mm	50 mm	3 mm	1
37218	50 mm	50 mm	4 mm	1

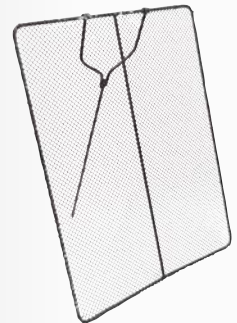

SITO U RAMU

Br.	Širina	Visina	Oko sito	
37236	0,8 m	1 m	10 mm	1
37237	0,8 m	1 m	12 mm	1
37238	0,8 m	1 m	16 mm	1
37239	0,8 m	1 m	20 mm	1



SMESA ZA POBOLJŠANJE BETONA

- +/- 150 g/ 50 kg cementu
- 600 - 900 g/m² beton ili malter



Br.	váha	
42115	0,9 kg	9



MREŽA ZAŠTITNA ZELENA

Br.	Specifikacije	
42120	2,5 x 20 m, 80 g/ m ² zelena	5



FASADERSKA MAŠINA



Br.		
37114		1



FASADERSKA MAŠINA



Br.	Specifikacije	
37115		1



KAJLA ZA FIKOMIRANJE POC.

Zn		
MOQ	10	
Br.	Specifikacije	
37231	14 cm labavo	10



KAJLA ZA FIKOMIRANJE KOVANA

MOQ	5	
Br.	Specifikacije	
37232	14,5 cm	5



KAJLA ZA FIKOMIRANJE

6x		
Br.	Specifikacije	
37230	16 cm	6

STEGA-KLANFA

Zn		
Br.	Specifikacije	
37233	320 x 10 mm	100
37234	320 x 12 mm	100



STEGA-KLANFA

Br.	Specifikacije	
37235	250 x 12 mm	1



PAPIRNATI UGAO SA DVIJE ALU TRAKE

ALU		
Br.	Specifikacije	
39245	AL 30 m x 5 cm	1

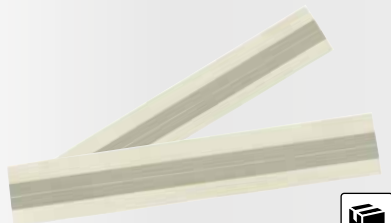

PLASTICNI UGAO

MADE IN EU		
Br.	Specifikacije	
39238	3 m	25



ŠPAKLA ZA GIPSANE PLOČE

PLASTIC		
Br.	Specifikacije	
34308	50 mm	20
34307	80 mm	12
34306	100 mm	10
34305	150 mm	12



POSTOLJE ZA POSTAVKU GIPS PLOČA

- 153 - 344 cm
- max. 54 kg

Br.	Specifikacije	
26775		1



KOMPLET ZA POSTAVLJANJE GIPSANIH PLOČA

Br.	Specifikacije	
34300	9 Kom	10
34303	Kanta	60



FESTA NOSAČ PLOČA

2x		
Br.	Specifikacije	
36312		12



FESTA NOSAČ PLOČA

Br.	Specifikacije	
36308	36 x 16,5 x 7,5 cm	10





RENDE
ZA GIP. PLOČE

Br.	Specifikacija	
22120	250 x 40 mm	10



RENDE
ZA GIP. PLOČE

Br.	Specifikacija	
22121	250 x 40 mm	10
22122	140 x 40 mm	6



RENDE
ZA GIP. PLOČE

Br.	Specifikacija	
22126	155 x 40 mm	1



RENDE ZA GIP. PLOČE

Br.	Specifikacija	
22125	Ø 250 x 40 mm	6



RENDE ZA GIP. PLOČE

Br.	Specifikacija	
22124	Ø 250 x 16 mm	10



RENDE
ZA GIP. PLOČE

Br.	Specifikacija	
22123	60 x 40 mm	6



FESTA
TESTERA ZA GIPSANE PLOČE

Br.	Specifikacija	
24159	150 mm	12



RENDE
ZA GIP. PLOČE

Br.	Specifikacija	
34315		10
34316	Rezervno břit	1



BOSNEK ZA GIP. PLOČE

Br.	Specifikacija	
24190	300 mm	10

RENDE REZERVA

Br.	Specifikacija	
22130	250 x 40 mm	20
22129	155 x 40 mm	20
22132	140 x 40 mm	20
22133	60 x 40 mm	20
22134	Ø 16 x 250 mm	20

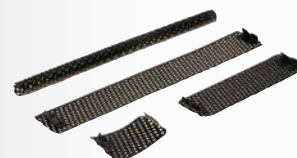

FESTA**BRENER KRAČI**

· Ø 17, 22, 40 mm



Br.	Specifikacije	
69918	2 kW, 3 m crijeva	10

**FESTA****BRENER KRAČI**

· Ø 25, 35, 50 mm



Br.	Specifikacije	
69919	19,5 kW, 1,5 m crijeva	10

**FESTA****BRENER KRAČI 300 MM**

Br.	Specifikacije	
69900	Ø 35 mm, Dužina 300 mm, bez crijeva	10
69901	Ø 35 mm, Dužina 300 mm + 3 m crijeva	5

**FESTA****BRENER KRAČI SA CREVOM 3 KW**

Br.	Specifikacije	
69914	300 mm + 2 m crijeva	5

**FESTA****BRENER KRAČI**

Br.	Specifikacije	
69902	Ø 55 mm, Dužina 550 mm, bez crijeva	10

**FESTA****BRENER KRAČI**

Br.	Specifikacije	
69903	Ø 55 mm, Dužina 550 mm + 3 m crijeva	10

**FESTA****BRENER KRAČI**

Br.	Specifikacije	
69905	Ø 55 mm, Dužina 900 mm, bez crijeva	10

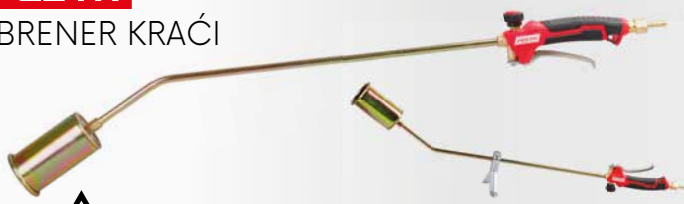
**FESTA****BRENER KRAČI**

Br.	Specifikacije	
69906	Ø 55 mm, Dužina 900 mm + 3 m crijeva	5



FESTA

BRENER KRAČI



· Ø 55 mm



Br.	Specifikacije	
69904	60 kW, 850 mm, 5 m crijeva	8

FESTA

BRENER KRAČI

· Regulator za priključenje 10 a 33 kg bombi



Br.	Specifikacije	
69917	Ø 60 mm, Dužina 900 mm + 3 m crijeva 3 m	1

FESTA

CREVO ZA BRENER KRAČI



Br.	Specifikacije	
69910	3 m sa završetkom	20
69911	5 m sa završetkom	12
69912	10 m sa završetkom	8



REDUCIRANI VENTIL PROPAN - BUTAN

Ulazni pritisak	25 bar
Izlazni pritisak	0,5 - 4,0 bar
Nominalni protok	16 kg h
inlet connection	W 21,8 x 1 14" LH
outlet connection	G3 8" LH



Br.	Specifikacije	
69907		1

REDUCIRANI VENTIL

Izlazni pritisak	4,0 bar
Nominalni protok	16 kg h
inlet connection	W 21,8 x 1 14" LH
outlet connection	G3 8" LH



Br.	Specifikacije	
69920		25

REDUCIRANI VENTIL PROPAN - BUTAN



Br.	Specifikacije	
69923	W 21,8; G 3/8; 4 bar	1

REGULATOR PRITISKA



Br.	Specifikacije	
69908	30 mBar, trn	1
69909	30 mBar, zavit G 1/4L	1

JEDNOSMERNI VENTIL PRITISKA

· Izlazni spoj G 3/8L, za bočicu od 2 kg



Br.	Specifikacije	
69928		1

**FESTA****PLINSKI BRENER NA NAVOJNOM ULOŠKU**

- maKom. temperatura 1200 °C
- energija 1,7 kW
- prečnik brenera Ø 20 mm



Br.	Specifikacije
69930	piezo

20

**FESTA****PLINSKI BRENER NA PIERCING KERTRIDŽU**

- maKom. temperatura 1200 °C
- energija 1,7 kW
- prečnik brenera Ø 20 mm



Br.	Specifikacije
69931	piezo

12

**ČINIJA ZA GIPS**

Br.	Specifikacije
37121	Konusna



1

**ČINIJA ZA GIPS**

Br.	Specifikacije
37122	Niska



1

**ČINIJA ZA GIPS**

Br.	Specifikacije
33275	Niska, guma



20

**POCINKOVANA KOFA****Zn**

Br.	Specifikacije
39000	5 l
39001	10 l
39002	12 l
39003	15 l



40

30

20

20

**KANTA ZIDARSKA**

Br.	Specifikacije
39005	5 l
39010	10 l
39012	12 l
39014	15 l Sa naljevom
39020	20 l
39021	20 l Sa naljevom



1

1

1

1

1

1

**KORITO**

Br.	Specifikacije
39192	30 l
39193	45 l



20

20

KANTA ZIDARSKA OKRUGLA

Br.	Specifikacije
39045	45 l Ø 54 x 27 cm
39065	60 l Ø 60 x 35 cm
39090	90 l Ø 66 x 35 cm



1

1

1

**KANTA ZIDARSKA CET.**

Br.	Specifikacije
39145	40 l 71 x 40 x 21 cm
39165	65 l 71 x 40 x 30 cm
39190	85 l 77 x 48 x 30 cm



1

1

1



FESTA

- drška otporna na udarce najlon + fiberglas



- 360° rotirajuća glava

Prekidač za korak unazad sa 3 položaja



- promena doze 9:1 / 18:1



FESTA

PIŠTOLJ ZA SILIKON SA POVRATNIM KORAKOM

Br. I No. Specifikacije / Specification

38027

1

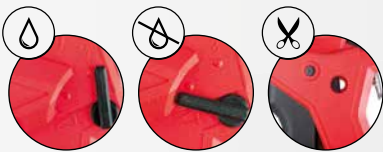

NEW



FESTA

PIŠTOLJ ZA SILIKON SA POVRATNIM KORAKOM

Č.p. Specifikacije

38032

nylonová



24

FESTA

PIŠTOLJ ZA SILIKON SA POVRATNIM KORAKOM



Br. I No. Specifikacije / Specification

38028

1

FESTA

PIŠTOLJ ZA SILIKON KOBRA



Br. Specifikacije

38013

12

FESTA

PIŠTOLJ ZA SILIKON KOBRA



Br. Specifikacije

38001

24

FESTA

PIŠTOLJ ZA SILIKON KOBRA



Br. Specifikacije

38012

6

FESTA

PIŠTOLJ ZA SILIKON KOBRA



Br. Specifikacije

38024

1

PIŠTOLJ
ZA SILIKON
SA POVRATNIM
KORAKOM



Br.	Specifikacije	
38010	Šestougaona	24

PIŠTOLJ ZA
SILIKON KOBRA



Br.	Specifikacije	
38025		24

FESTA

PIŠTOLJ ZA
SILIKON (HEMIC)
380 ML



Br.	Specifikacije	
38020		12

PIŠTOLJ ZA
SILIKON
SCORPION



Br.	Specifikacije	
38006		12

PIŠTOLJ
ZA SILIKON



Br.	Specifikacije	
38002	6ti hran	24

PIŠTOLJ
ZA SILIKON
PLASTIČNI



Br.	Specifikacije	
38003	6ti hran	24

PIŠTOLJ
ZA SILIKON
(HROM)



Br.	Specifikacije	
38007		24

PIŠTOLJ
ZA SILIKON
POLUZATVORENI
PVC



Br.	Specifikacije	
38008		24

PIŠTOLJ
ZA SILIKON
HOBI



Br.	Specifikacije	
38009		24

PIŠTOLJ
ZA SILIKON
HOBI



Br.	Specifikacije	
38000		24

FESTA

PIŠTOLJ ALU



ALU

Br.	Specifikacije	
38005	310 ml	20
38014	vrh 3 Kom	100

FESTA

PIŠTOLJ ALU



ALU

Br.	Specifikacije	
38004	600 ml	12
38014	vrh 3 Kom	100

FESTA

PIŠTOLJ ZA PUR PENU TEFLON



TEFLON

Br.	Specifikacije	
38018		20

FESTA

PIŠTOLJ ZA PUR PENU TEFLON



TEFLON

Br.	Specifikacije	
38017		20

FESTA

PIŠTOLJ ZA MONTAŽNU PENU PUR



TEFLON

Br.	Specifikacije	
38016		20

FESTA

PIŠTOLJ ZA MONTAŽNU PENU PUR



TEFLON

Br.	Specifikacije	
38015		20

PIŠTOLJ ZA MONTAŽNU PENU PUR



Br. 38031

Specifikacije

20

FESTA

PIŠTOLJ ZA MONTAŽNU PENU PUR



Br. 38022

Specifikacije ABS

20

PIŠTOLJ ZA MONTAŽNU PENU PUR



Br. 38021

Specifikacije

24

REZERVNA MLAZNICA ZA PIŠTOLJ ZA PU PJENU

Za pistolj 38015, 38016, 38017, 38018

TEFLON

Br. 38030

Specifikacije

5





ČETKA

Br.	Širina	Debljina	Dužina	
52212	20 mm	15 mm	40 mm	12
52213	30 mm	15 mm	45 mm	12
52214	40 mm	15 mm	45 mm	12
52215	50 mm	15 mm	50 mm	12
52216	60 mm	15 mm	60 mm	12
52217	70 mm	15 mm	65 mm	12
52218	80 mm	15 mm	65 mm	12
52220	100 mm	15 mm	70 mm	12



ČETKA

Br.	Širina	Debljina	Dužina	
52202	20 mm	12,5 mm	38 mm	12
52203	30 mm	13 mm	38 mm	12
52204	40 mm	14 mm	44 mm	12
52205	50 mm	16 mm	44 mm	12
52206	60 mm	17 mm	52 mm	12
52208	80 mm	17 mm	52 mm	12
52207	100 mm	18 mm	52 mm	12

ČETKA ZA BOJENJE
RADIJATORA

Br.	Širina	Debljina	Dužina	
52283	25 mm	10 mm	44 mm	12
52284	38 mm	10 mm	44 mm	12
52285	50 mm	10 mm	44 mm	12
52286	62 mm	10 mm	50 mm	12
52288	76 mm	10 mm	50 mm	12



KOMPLET ČETKI

Br.	Specifikacije	
52070	20, 30, 50 mm	50



ČETKA OKRUGLA

Br.	Specifikacije	
52075	Ø 90 mm	10



ČETKA ČETVRTASTA

Br.	Širina	Dužina	
52076	170 mm	80 mm	10



KOMPLET ČETKI

Br.	Specifikacije	
52071	15 mm, 25 mm, 40 mm, 60 mm, 80 mm	50



ČETKA OKRUGLA

Br.	Širina	Dužina	
52077	Ø 105 mm	70 mm	12



ČETKA ČETVRTASTA

Br.	Širina	Dužina	
52078	170 mm	70 mm	12

APPLICATION OF THE ROLLERS		Paints or varnishes (lacquers)												
Material	tickness of Pile mm	DISPERSION	ANTICORROSIVE	RESIN	OIL	WATER DIL.	POLYESTER	BINDER	GLAZING	LATEX	EPOXY	2-COMPONENT	THICK	ACRYLIC
PES	20	•						•		•			•	
PES	20	•	•			•		•		•				•
PAC	18	•						•		•				
PAC	12, 13	•								•				
PAD	18, 21	•								•				
PAD	13	•	•							•				
LAMBSKIN	23	•								•				
NYLON	13		•	•	•	•	•			•	•	•		
VELOUR	4		•	•			•				•	•	•	
MICROFIBRE	10					•			•	•				
MOLITAN				•		•								•

VALJAK POLYAKRYL

PAC

MADE IN EU

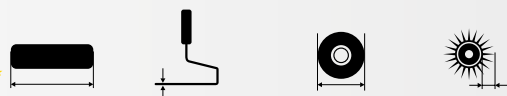

Br.						
52331	100 mm	Ø 6 mm	Ø 17 mm	12 mm	50	
52334	250 mm	Ø 8 mm	Ø 48 mm	12 mm	10	



VALJAK POLYAKRYL

PAC

MADE IN EU



Br.						
52391	polster 5	250 mm	Ø 8 mm	Ø 54 mm	18 mm	10



VALJAK POLYAKRYL

PAC

MADE IN EU



Br.						
52328	polster 5	250 mm	Ø 8 mm	Ø 54 mm	18 mm	10
52456	polster 7	250 mm	Ø 8 mm	Ø 67 mm	18 mm	10



VALJAK POLYAMID

PAD

MADE IN EU



Br.						
52428	polster 7	250 mm	Ø 8 mm	Ø 67 mm	18 mm	10



LAKIRNI VALJAK, NYLON

PAD

MADE IN EU



Br.						
52421	100 mm	Ø 6 mm	Ø 17 mm	13 mm	50	
52424	250 mm	Ø 8 mm	Ø 48 mm	13 mm	10	



VALJAK POLYESTER

PES

MADE IN EU

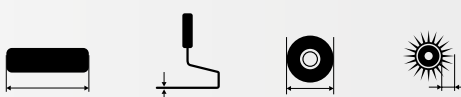

Br.						
52305	180 mm	Ø 6 mm	Ø 42 mm	20 mm	10	
52306	250 mm	Ø 6 mm	Ø 42 mm	20 mm	10	



VALJAK ZA LAKIRANJE , POLIESTER FINA PENA

MADE IN EU

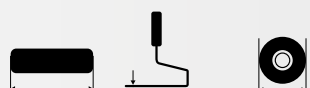

Br.						
52471	Ravno	100 mm	Ø 6 mm	Ø 35 mm	50	



SET ZA FARBANJE

PAC

MADE IN EU

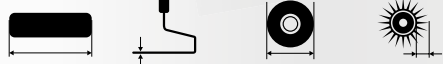

Br.	Specifikacije	Objem	Šifra
52600	polster 4 180 mm Ø 8 mm Ø 53 mm 18 mm	1	

SET ZA FARBANJE VESTAN

PES

MADE IN EU

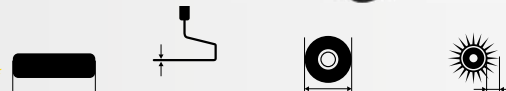

Br.	Specifikacije	Objem	Šifra
52610	180 mm Ø 6 mm Ø 42 mm 20 mm	25	
52605	250 mm Ø 6 mm Ø 42 mm 20 mm	20	

SET ZA FARBANJE

- 1x Valjak PAD 13 mm/ 10 cm
- 1x Valjak PAC 12 mm/ 10 cm
- 1x Valjak PES 11 cm
- Drška + Posuda

MADE IN EU



Br.	Objem	Šifra
52602	10	

VALJAK ZA ČOŠKOVE

PAC

MADE IN EU

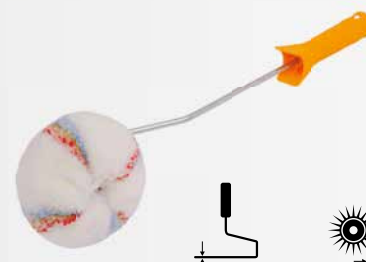

Br.	Specifikacije	Objem	Šifra
52601	sa drškom Ø 6 mm 18 mm	1	

KADICA ZA CEĐENJE

MADE IN EU



Br.	Specifikacije	Objem	Šifra
52662	150 x 270 mm 100 mm	1	
52666	260 x 290 mm 180 mm	1	
52671	330 x 340 mm 250 mm	1	

KANTA ZA BOJU

MADE IN EU



Br.	objem	Šifra
52694	8 l	25
52695	12 l	20

MREŽICA

MADE IN EU



Br.	Širina	Visina	Objem
52652	230 mm	250 mm	100
52656	270 mm	290 mm	100



DRŽAČ VALJKA

MADE IN EU



DRŽAČ VALJKA



Br.	Specifikacije	Objem
52640	5 cm Ø 6 mm	100
52645	8,5 cm Ø 6 mm x 27 mm	100

MADE IN EU

Br.	Specifikacije	Objem
52630	18 cm Ø 6 mm	100
52635	25 cm Ø 6 mm	100
52620	18 cm Ø 8 mm	50
52625	25 cm Ø 8 mm	50

STRUGAČ ZA BOJE I LAKOVE



Br.	Objem	Šifra
37005	12	

FESTA

ŠTAP TELESKOPSKI

konac za 31610, 34203

Br.	Specifikacija	
52011	88 - 140 cm	1



ŠTAP TELESKOPSKI

ALU

Br.	Dužina		
52010	120 cm	ALU	50
52012	240 cm	ALU	25



ŠTAP TELESKOPSKI

Br.	Dužina		
52020	300 cm	Čelik	10



ŠTAP TELESKOPSKI

Br.	Dužina		
52030	240 cm	fiberglass	6



SAMOLJ. ZAŠTITNA FOLIJA

Br.	Širina	Dužina	
37243	55 cm	30 m	60
37244	110 cm	30 m	30
37245	140 cm	30 m	30
37246	180 cm	15 m	30
37290	210 cm	20 m	30
37247	240 cm	15 m	30
37291	270 cm	16 m	30



KOMBINEZON SA KAPULJAČOM

Br.	Specifikacije	
50585	veličina M	1
50586	veličina L	1
50587	veličina XL	1
50588	veličina XXL	1



FOLIJA ZAŠTITNA

Br.	Specifikacije	
37248	1,2 x 2,2 m 100 µm	Traka 45 mm x 25 m 25



FOLIJA ZAŠTITNA

Br.	objem	Debljina	
37250	4 x 5 m	0,007 mm	100
37251	4 x 12,5 m	0,007 mm	50
37252	2 x 50 m	0,007 role	20



FOLIJA ZAŠTITNA

Br.	Specifikacije	Debljina	
37253	4 x 5 m	0,03 mm	100



VALOVITI KARTON

Br.	Širina	Dužina	
54008	1 m	10 m	1

FESTA



PE FOLIJA
ZAŠITNA
PROFI

· Plav-srebro

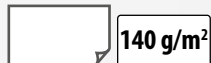

Br.	Specifikacije	
25206	2 x 3 m	25
25212	3 x 4 m	10
25215	3 x 5 m	8
25220	4 x 5 m	8
25224	4 x 6 m	8
25230	5 x 6 m	8

Br.	Specifikacije	
25240	5 x 8 m	4
25248	6 x 8 m	3
25260	6 x 10 m	3
25296	8 x 12 m	2
25350	10 x 15 m	1



PE FOLIJA
ZAŠITNA
EKONOMIK

· Plav



Br.	Specifikacije	
25369	2 x 2 m	50
25370	2 x 3 m	20
25371	3 x 4 m	10
25372	3 x 5 m	10
25373	4 x 5 m	10

Br.	Specifikacije	
25374	4 x 6 m	5
25376	5 x 8 m	5
25378	6 x 10 m	2
25379	8 x 12 m	2
25380	10 x 15 m	2

PE FOLIJA
ZAŠITNA
STANDARD

· Plav-srebro



Br.	Specifikacije	
25155	2 x 2 m	50
25006	2 x 3 m	50
25009	3 x 3 m	35
25012	3 x 4 m	20
25015	3 x 5 m	10
25016	4 x 4 m	10
25020	4 x 5 m	10
25024	4 x 6 m	10

Br.	Specifikacije	
25025	5 x 5 m	10
25030	5 x 6 m	10
25040	5 x 8 m	5
25048	6 x 8 m	5
25060	6 x 10 m	5
25096	8 x 12 m	2
25150	10 x 15 m	2
25153	15 x 20 m	1

PE FOLIJA
ZAŠITNA
STANDARD

· Zelen

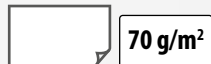

Br.	Specifikacije	
25179	2 x 2 m	50
25180	2 x 3 m	50
25195	2 x 8 m	20
25181	3 x 4 m	20
25182	3 x 5 m	10
25183	4 x 5 m	10

Br.	Specifikacije	
25184	4 x 6 m	10
25186	5 x 8 m	5
25188	6 x 10 m	5
25189	8 x 12 m	2
25190	10 x 15 m	2

PE FOLIJA
ZAŠITNA
PROFI

· Zelen



Br.	Specifikacije	
25160	2 x 3 m	15
25171	2 x 8 m	1
25162	3 x 5 m	5
25163	4 x 5 m	4

Br.	Specifikacije	
25164	4 x 6 m	3
25167	6 x 8 m	2
25169	8 x 12 m	1
25170	10 x 15 m	1

PE FOLIJA
ZAŠITNA
OKRUGLA

· Plav-srebro



Br.	Specifikacije	
25003	Ø 3,6 m	15
25004	Ø 4,5 m	5
25005	Ø 5,5 m	4
25002	Ø 6,5 m	3



ZATEZAČ TRAKE

Br.	Specifikacije	
25400	20 cm	1

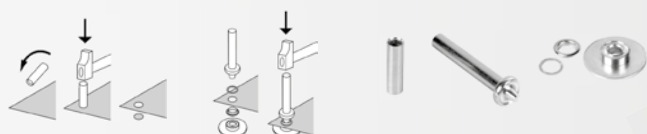

ALKE ZA
ZAŠITNU FOLIJU

10x

Br.	Specifikacije	
25410	Aplikator ok + 25 ok	1

Br.	Specifikacije	
25001		1



TELESKOPSKE SKLOPIVE MERDEVINE

· max. 150 kg



Br.	Specifikacije	
48415	1,9 / 3,8 m	6/12 pregrada 1

TELESKOPSKE MERDEVINE

· max. 150 kg



Br.	Specifikacije	
48410	3,2 m	11 pregrada 1
48411	3,8 m	13 pregrada 1

PREKLOPNA RADNA PLATFORMA

· max. 150 kg



Br.	Specifikacije	
48420		1



NEW

2.75m	H L	H L	1.73m	0.93m	0.99m
	1.60m 1.14m	1.69m 1.32m			

RADNA PLATFORMA



· max 150 kg

Br.	Specifikacije	
37660		1





PODESEVI NASLON



Br.	Specifikacije	
37545	140 cm, Visina 98 - 165 cm	1
37546	120 cm, Visina 98 - 165 cm	1



PODUPIRAČ

· 48449 Kavez za nosače



Br.	Specifikacije	
48452	160 - 290 cm	1
48453	180 - 320 cm	1
48454	200 - 360 cm	1
48455	250 - 440 cm	1
48456	260 - 380 cm	1
48457	220 - 400 cm	1

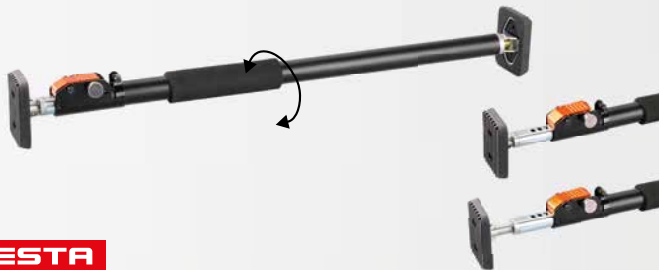

FESTA

PODUPIRAČ

· max. 40 kg

Br.	Specifikacije		
52060	66 - 115 cm	1	
52065	160 - 290 cm	1	



PODUPIRAČ

Br.	Specifikacije		
52050	50 - 115 cm	1	
52055	115 - 290 cm	1	

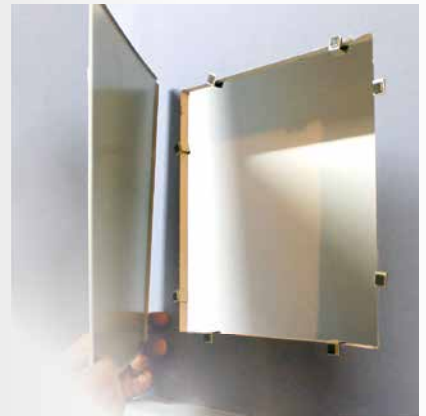

REVIZIONA VRATANCA MAGNETIC

	Br.	Specifikacije	
	82100	10 - 21 cm	1
	82101	20 - 31 cm	1
	82102	30 - 41 cm	1
	82103	40 - 51 cm	1
	82104	50 - 58 cm	1



VRATA ZA DIMNJAK



Br.	Specifikacije	
65062		1



VRATA ZA DIMNJAK KOMAX



Br.	Specifikacije	
65063	šedá	1
65064	bílá	1



VRATA ZA DIMNJAK POCINKOVANA



Br.	Specifikacije	
65065		1



310

WINLAND VRTNE MAKAZE



312

VRTNE MAKAZE



315

MAČETI, VRTNE ALAT



315

BAŠTENSKÉ TESTERE



316

SEKIRE



318

BAŠTENSKI ALATI



320

BRUSEVI



321

STRUNE ZA KOSILICE



321

NETKANE FOLIE



322

ŠTAPOVI ZA PARADAJZ I
BAŠTU

324

BAŠTENSKI PRIBOR ZA
ZALIVANJE

332

SPOJNICE ZA ZALIVNA
CREVA

333

KOLICA I DRŽAČI CREVA



334

BAŠTENSKÉ KANTE
ZA ZALIJEVANJE

335

PRSKALICE



337

GRABULJE I METLICE



341

VILE, LOPATE



348

ČETKE I METLE



350

DRZALJE

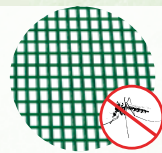

352

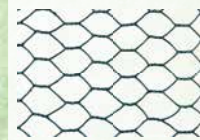
MREŽICE PROTIV
KOMARACA

353

PLETIVA I ZICE



356

VIJAKA ZA ZEMLJU



357

MREŽA ZAŠTITNA



358

PRIBOR ZA ROSTILJ



BASTENSKI ALAT

308 - 359



WINLAND®
MAKAZE

Br.	specifikacija	
45020	205 mm	10
44980	opruge za makaza	1

WINLAND®
MAKAZE

Br.	specifikacija	
45023	205 mm	10
44980	opruge za makaza	1

WINLAND®
MAKAZE

Br.	specifikacija	
45063	215 mm	10
44981	opruge za makaza	1

WINLAND®
MAKAZE

Br.	specifikacija	
44972	215 mm	10
44981	opruge za makaza	1

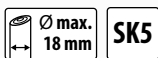
WINLAND®
MAKAZE

Br.	specifikacija	
45099	190 mm	10
44983	opruge za makaza	1

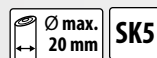
WINLAND®
MAKAZE

Br.	specifikacija	
45098	220 mm	10
44983	opruge za makaza	1

WINLAND®
MAKAZE

Br.	specifikacija	
45095	200 mm	10
44982	opruge za makaza	1

WINLAND®
MAKAZE

Br.	specifikacija	
45096	220 mm	6
44982	opruge za makaza	1





MAKAZE



INOX max. mm INOX

Br.	specifikacija	
45089	160 mm	10



MAKAZE



SK5 TEFLON SK5 TEFLON

Br.	specifikacija	
45097	210 mm	10
44981	opruge za makaza	1



MAKAZE



INOX max. 10 mm

Br.	specifikacija	
45088	160 mm	10



max. 12 mm

MAKAZE - TELESKOPSKE

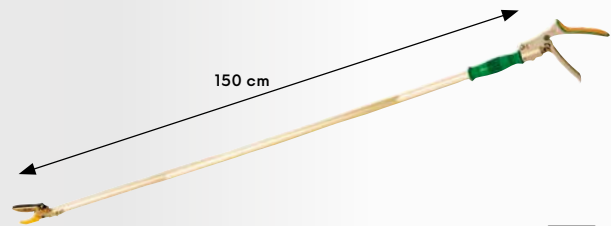

Br.	specifikacija	
45017		10



OPRUGE ZA MAKAZA



Br.	Za makaze	
44981	45021, 45025, 45063, 45097	1
44980	45020, 45023	1
44983	45098, 45099	1
44982	45027, 45095, 45096	1
44984	45110, 45014, 45026	1
44985	45018	1



REZERVNI NOŽEVI

Za makaze 45095, 45027



Br.	specifikacija	
45094		20



MAKAZE ZA GRANE



max. 45mm SK5 TEFLON

Br.	specifikacija	
44991	76 cm	12



MAKAZE ZA GRANE TELESKOPSKE



max. 45mm SK5 TEFLON

Br.	specifikacija	
44992	70 - 103 cm	10



MAKAZE ZA ŽIVU OGRADU

TEFLON



Br.	specifikacija	
44996	61 cm, talasasto sečivo	12



MAKAZE ZA ŽIVU OGRADU

TEFLON



Br.	specifikacija	
44997	61 cm, ravna oštrica	12



MAKAZE ZA TRAVU OKRETNE 360°



Br.	specifikacija	
44998		6



NOŽ I DODACI ZA OSTRENJE 6 V 1



Br.	specifikacija	
45068		10



NOŽ I DODACI ZA OSTRENJE



Br.	specifikacija	
45048		20

FESTA

MAKAZE

· Najlonska drška



Br.	specifikacija	
45021	210 mm	6

MAKAZE



Br.	specifikacija	
45019	210 mm	10



FESTA

MAKAZE

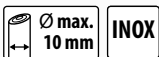

Br.	specifikacija	
45010	190 mm	12
44984	opruge za makaza	1

MAKAZE

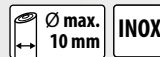

Br.	specifikacija	
45014	190 mm	12
44984	opruge za makaza	1

MAKAZE

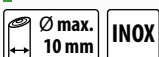

Br.	specifikacija	
45026	150 mm	12
44985	opruge za makaza	1

MAKAZE

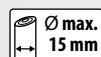

Br.	specifikacija	
45018	210 mm kovane	10

MAKAZE



Br. 45025
specifikacija 200 mm

12

MAKAZE



Br. 44970
specifikacija 210 mm

10

MAKAZE

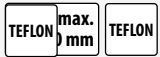

Br. 45027
specifikacija 200 mm

10

MAKAZE



Br. 45029
specifikacija 200 mm

24

MAKAZE

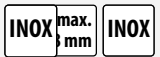

Br. 44971
specifikacija 160 mm

10

MAKAZE

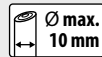

Br. 45016
specifikacija 180 mm

12

MAKAZE

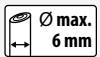

Br. 45015
specifikacija 190 mm, Ravne

12

NAVLAKA ZA MAKAZE



Br. 37317
specifikacija

1

MAKAZE ZA TRAVU

Br. 45011
specifikacija 300 mm



1

MAKAZE ZA TRAVU OKRETNE 180°

Br. 45012
specifikacija 370 mm, Okretne 180°

1



MAKAZE ZA GRANE



Br. 44999
specifikacija 540 mm, oble

12

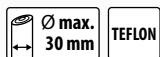

FESTAMAKAZE
ZA GRANE

Br.	specifikacija
45000	750 mm, oble

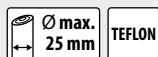
**FESTA**MAKAZE
ZA GRANE

Br.	specifikacija
45001	710 mm, oble

**FESTA**MAKAZE
ZA GRANE

Br.	specifikacija
45002	750 mm, Sa graničnikom

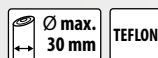
MAKAZE
ZA GRANE
TELESKOPSKE

Br.	specifikacija
45003	660-900 mm, teleskopski

**FESTA**

MAKAZE ZA ŽIVU OGRADU

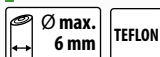

Br.	specifikacija
45005	580 230 mm, Valovita oštrica

**FESTA**

MAKAZE ZA ŽIVU OGRADU

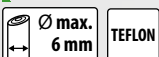

Br.	specifikacija
45006	580 230 mm, Ravna oštrica

**FESTA**MAKAZE ZA ŽIVU OGRADU
TELESKOPSKE

Br.	specifikacija
45007	670-870 230 mm, Valovita oštrica



MAKAZE ZA ŽIVU OGRADU



Br.	specifikacija
44995	440 160 mm



MAKAZE ZA ŽIVU OGRADU



Br.	specifikacija
45009	500 190 mm, Valovita oštrica



MAKAZE ZA ŽIVU OGRADU



Br.	specifikacija
45008	500 190 mm, Ravna oštrica

**SRP**

Br.	specifikacija
45490	450 mm



FESTA
MACETA



TEFLON

Br.	specifikacija	
45069	440 mm	6

FESTA
MACETA



TEFLON

Br.	specifikacija	
44950	490 mm	4

MACETA
ROSTFREI

INOX

Br.	specifikacija	
45083	430 mm	12
45084	600 mm	6



MACETA

· Drvena drška (jasen)

Br.	specifikacija	
45081	510 mm	36
45082	710 mm	36



FESTA
PREKLOPNA TESTERA

· Trostrano naoštreni zubi, termički ojačani zubi

Br.	Specifikacija	
45061	150 mm with cover of handle	12



FESTA
TESTERA ZA GRANE PREKLOPNA

· Trostrano naoštreni zubi, termički ojačani zubi

Br.	Specifikacija	
45060	180 mm	6



FESTA
TESTERA ZA GRANE

· Trostrano naoštreni zubi, termički ojačani zubi

Br.	Specifikacija	
45062	260 mm with case	24



FESTA
TESTERA ZA GRANE

· Trostrano naoštreni zubi, termički ojačani zubi

Br.	Specifikacija	
24152	350 mm 7 tpi	12



FESTA
TELESKOPSKA TESTERA

· Trostrano naoštreni zubi, termički ojačani zubi

Br.	Specifikacija	
45033	230 - 490 mm	1



TESTERA
ZA GRANE
SA KANAPOM

Br.	Specifikacija	
45030	pilka 30 cm Teleskopska mjerna šipka 240 cm	6
45031	pilka 30 cm	6



TESTERA ZA GRANE
SA KANAPOM

Br.	Specifikacija	
45032	Metalna bez pile	6



FESTA



FESTA

SEKIRA

DIN 5131 DIN 7294

- Drška jasen
- Kružni klin



Br.	specifikacija		Br.	specifikacija	
19380	600 g	1	19384	1400 g	1
19381	800 g	1	19385	1600 g	1
19382	1000 g	1	19387	2000 g	1
19383	1250 g	1			

FESTA

SEKIRA
TESARSKA

- Drška jasen



Br.	specifikacija	
19340	700 g	22



FESTA

ČEKIĆ SEKIRA

- Drška jasen
- Kružni klin

DIN 5129	Br.	specifikacija	
	19389	3000 g	1
	19388	4000 g	1



FESTA

SEKIRA ZA CEPANJE

- Drška jasen
- Kružni klin

DIN 7294	Br.	specifikacija	
	19391	2000 g	1

FESTA

SEKIRA FIBERGLASS

- Fiberglass

Č.p.	specifikace	
19326	600 g	6
19328	800 g	24
19330	1000 g	12
19332	1250 g	8
19333	1500 g	6
19335	1600 g	6
19337	2000 g	6



FESTA

SEKIRA
ZA CEPANJE

- Fiberglass

Č.p.	specifikace	
19392	1000 g	6



FESTA

SEKIRA CAMP
FIBERGLASS

- Fiberglass

Č.p.	specifikace	
19301	500 g	6



FESTA

SEKIRA ZA CEPANJE

- Fiberglass

Br.	specifikacija	
19390	2000 g	6





FESTA

ČEKIĆ SEKIRA

Fiberglass

Br.	specifikacija	
19370	3000 g	4
19371	4000 g	4



DRŽALJA ZA SEKIRE
JASEN



Č.p.	specifikace	pro sekeru	
61340	36 cm	19380	10
61341	40 cm	19381, 19340	10
61342	50 cm	19382	10
61343	70 cm	19383, 19384	10
61344	80 cm	19385, 19391	10
61345	90 cm	19387	10
61346	90 cm	19388, 19389	10

SEKIRA

Č.p.	specifikace	
19306	600 g	24
19308	800 g	24
19310	1000 g	24
19312	1250 g	12
19314	1500 g	12



KLIN ŠUMSKI

Br.	specifikacija	
19397	2000 g 55 x 210 x 45 mm	10
19465	2500 g 65 x 230 x 45 mm	10



KLIN ŠUMSKI PLASTIČNI



Br.	specifikacija	
19462	175 x 65 x 20 mm	1
19463	230 x 70 x 30 mm	1
19464	240 x 75 x 40 mm	1



KLIN ŠUMSKI

Br.	specifikacija	
19394	1000 g 35 x 180 x 40 mm	6
19395	2000 g 40 x 255 x 55 mm	6
19396	2500 g 40 x 260 x 55 mm	8



TRN ZA CEPANJE SDS+

SDS+

Br.	Specifikacija	
19393	Ø 32 x 132 mm	10
19374	Ø 42 x 145 mm	10



KLIN ŠUMSKI

Br.	specifikacija	
19469	2500 g 165 x 87 mm	10

LOPATICA ŠIROKA ROSTFREI

INOX



Br.	specifikacija	
45056	360 mm	12

LOPATICA USKA ROSTFREI

INOX



Br.	specifikacija	
45057	360 mm	12

MOTIKA MALA ROSTFREI

INOX



Br.	specifikacija	
45058	270 mm	12

ALAT ZA PLJEVLJENJE SA LOPATICOM ROSTFREI

INOX



Br.	specifikacija	
45059	360 mm	12

LOPATICA ŠIROKA

NYLON



Br.	specifikacija	
45065	280 mm	1

LOPATICA USKA

NYLON



Br.	specifikacija	
45066	310 mm	1

BAŠTENSKA VILA

NYLON



Br.	specifikacija	
45067	290 mm	1

ALAT ZA CVEČE SET

HOBBY

4x



Br.	specifikacija	
45035	240 mm	35

MOTIKA



Br.	specifikacija	Dužina drške	
61294	140 mm	27 cm	MOQ 3
61221	drška	27 cm	1

MOTIKA



Br.	specifikacija	Dužina drške	
61295	140 mm	27 cm	MOQ 3
61221	drška	27 cm	1

MOTIKA



Br.	specifikacija	Dužina drške	
61296	175 mm	27 cm	MOQ 3
61221	drška	27 cm	1

MOTIKA



Br.	specifikacija	Dužina drške	
61297		27 cm	MOQ 3
61221	drška	27 cm	1



LOPATA NA SKLAPANJE

· Navlaka

Br.	specifikacija	
61085	410 mm	6



SADILJKA

INOX

Br.	specifikacija	
45040	230 mm	60



SADILJKA "T"

Br.	specifikacija	
45038	280 mm	60



NOŽ ZA KOROV

Br.	specifikacija	
45079	200 mm	1



NOŽ ZA KOROV

Br.	specifikacija	
45080	200 mm „L“	1



BERAČICA ZA PLODOVE



Br.	specifikacija	
45041		75



BERAČICA ZA PLODOVE

Br.	specifikacija	
45039		50
45034	170 - 300 cm, Sa teleskop drskom	5



ŠTAP TRON. ZA PLJEVLJENJE

Br.	specifikacija	
44955	950 mm	16



KULTIVATOR RUČNI

Br.	specifikacija	
45042	160 x 132 cm	12



KULTIVATOR RUČNI

Br.	specifikacija	
44053		12
61251	160 cm drška	1



TOVARNA KOLICA

DIMENZIJE

Visina:	111 cm
Širina:	55 cm
Zapremina rezervoara	12 l

Br.	specifikacija	
45085	12 l	1

FESTA

NOŽ I DODACI ZA OSTRENJE 16v1



	30° Anvil	
	45° Anvil	
	50° Anvil	
	23° Bypass	
	35° Bypass	
	65° Bypass	
	Debur Tool	



Br. specifikacija **45073** 1



NOŽ I DODACI ZA OSTRENJE 6 V 1



Br. specifikacija **45068** 10



NOŽ I DODACI ZA OSTRENJE



Br. specifikacija **45048** 20



BRUS ZA KOSU

Br. specifikacija **45046** 205 x 15 mm 100



BRUS ZA KOSU

Br. specifikacija **45370** 250 x 33 x 18 mm 20



BRUS ZA KOSU

Br. specifikacija **45045** 150 x 50 x 30 mm 10



NOŽ I DODACI ZA OSTRENJE

Br. specifikacija **16991** 20



BRUS

Br. specifikacija **16990** Ø 50 mm 50





STRUNA ZA KOSILICU SA NAJLONSKIM CENTROM



Br.	specifikacija		
45530	2 mm x 15 m	■	1
45531	2,4 mm x 15 m	■	1
45532	3 mm x 15 m	■	1
45533	3,15 mm x 15 m	■	1
45534	4 mm x 15 m	■	1



STRUNA ZA KOSILICU



STRUNA ZA KOSILICU

Br.	specifikacija		
45520	2 mm x 162 m	●	10
45521	2,4 mm x 112 m	●	10
45528	2,7 mm x 90 m	●	10
45522	3 mm x 72 m	●	10
45525	2 mm x 162 m	★	10
45526	2,4 mm x 112 m	★	10
45529	2,7 mm x 90 m	★	10
45527	3 mm x 72 m	★	10

Br.	specifikacija		
45500	1,3 mm x 15 m	●	30
45502	1,3 mm x 15 m	★	30
45503	1,6 mm x 15 m	●	20
45505	1,6 mm x 15 m	★	20
45506	2 mm x 15 m	●	12
45508	2 mm x 15 m	★	12
45517	2 mm x 15 m	■	10
45509	2,4 mm x 15 m	●	12
45511	2,4 mm x 15 m	★	12
45512	2,4 mm x 15 m	■	12
45518	2,4 mm x 15 m	■	10
45523	2,7 mm x 15 m	●	10
45524	2,7 mm x 15 m	★	10
45513	3 mm x 15 m	●	10
45515	3 mm x 15 m	★	10
45516	3 mm x 15 m	■	10
45519	3 mm x 15 m	■	10



NETKANA FOLIJA



17 g/m²

Br.	specifikacija		
45540	1,6 x 5 m		40
45541	1,6 x 10 m		40
45542	1,6 x 50 m	u ulozu	1
45543	1,6 x 100 m	u ulozu	1



NETKANA FOLIJA



50 g/m²

Br.	specifikacija		
45550	1,6 x 5 m		50
45551	1,6 x 10 m		20
45564	3,2 x 10 m		20
45552	1,6 x 50 m	u ulozu	1
45553	1,6 x 100 m	u ulozu	1
45562	3,2 x 50 m	u ulozu	1
45563	3,2 x 100 m	u ulozu	1



NETKANA FOLIJA



50 g/m²

Br.	specifikacija		
45556	1,6 x 5 m		50
45557	1,6 x 10 m		20
45565	3,2 x 10 m		20
45558	1,6 x 50 m	u ulozu	1
45559	1,6 x 100 m	u ulozu	1

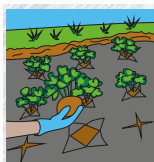

NETKANA FOLIJA

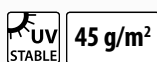

Br.	specifikacija	
45535	1,6 x 5 m	18

PIN ZA PRIČVRŠČIVANJE
MULČ. TKANINE

10x	Br.	specifikacija	
	45555	11,5 cm	1

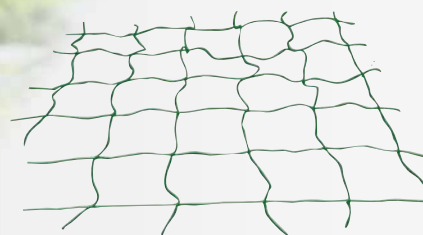
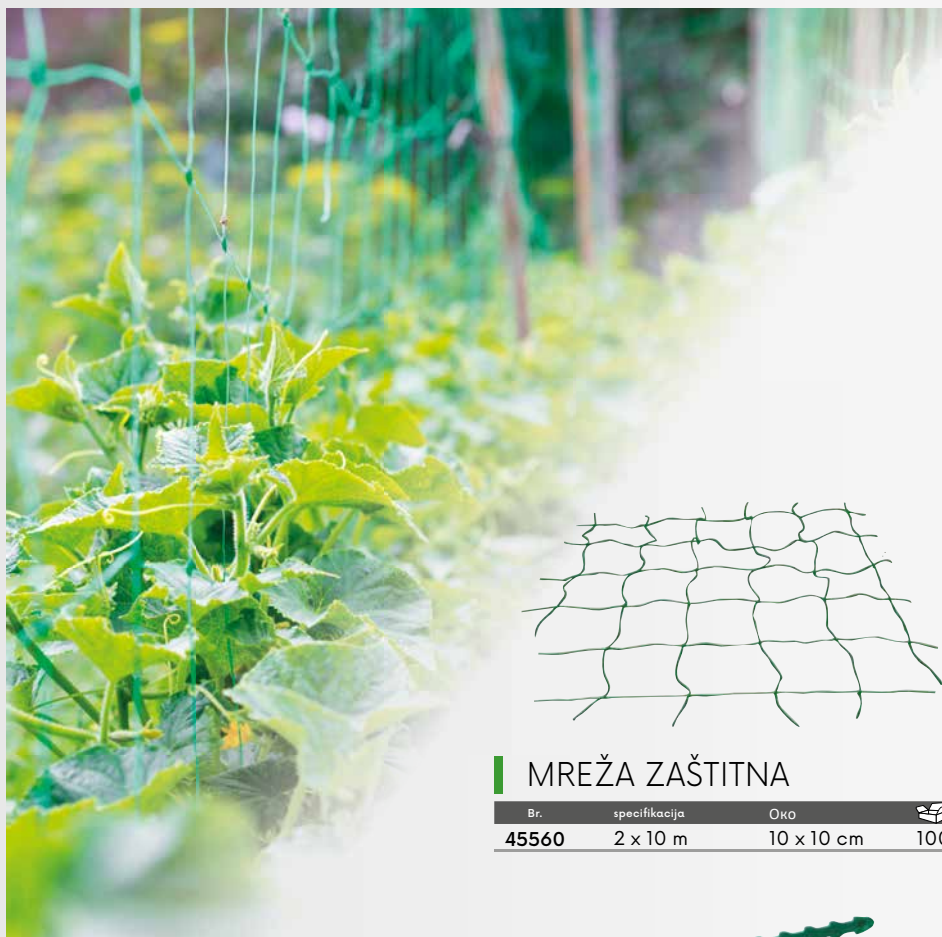

MREŽA ZAŠTITNA

Br.	specifikacija	Okro	
45560	2 x 10 m	10 x 10 cm	100



KOLČIČ FIBERGLAS

Br.	specifikacija	
45036	180 cm Ø 7,9 mm	100



VEZICA NAZUBLJENA

50x	Br.	specifikacija	
	23840		20



KOLČIČ PLASTIČNI

Br.	specifikacija		Br.	specifikacija		Br.	specifikacija	
45650	90 cm Ø 8 mm	25	45655	150 cm Ø 11 mm	25	45659	180 cm Ø 16 mm	25
45651	120 cm Ø 8 mm	25	45656	180 cm Ø 11 mm	25	45660	210 cm Ø 16 mm	25
45652	150 cm Ø 8 mm	25	45661	210 cm Ø 11 mm	25	45662	150 cm Ø 20 mm	10
45653	90 cm Ø 11 mm	25	45657	120 cm Ø 16 mm	25	45663	180 cm Ø 20 mm	10
45654	120 cm Ø 11 mm	25	45658	150 cm Ø 16 mm	25	45664	210 cm Ø 20 mm	10



KOLČIČ ZA PARADAJZ SPIRALNI

Br.	specifikacija	
44041	1,2 m, Ø 5,5 mm Komaxit - green	10
44042	1,5 m, Ø 6 mm Komaxit - green	10
44043	1,8 m, Ø 6 mm Komaxit - green	10
45049	1,8 m, Ø 7 mm Komaxit - green	10
45044	1,8 m, Ø 7 mm Komaxit - silver	10
44050	2,2 m, Ø 7 mm Komaxit - green	10



SPOJNICA ZA KOLČIČE

Br.	specifikacija	
45670	8 mm	10
45671	11 mm	10
45672	16 mm	10
45673	20 mm	10

MOQ
10



TRAKA ZA VEZANJE
VELCRO

Br.	specifikacija	
45471	12 mm x 5 m	1



ŽICA ZA VEZANJE PVC

Br.	specifikacija	
45043	30 m	30

ŽICA
ZA VEZANJE
PVC

Br.	specifikacija	
23845	3 mm x 8 m	30
23846	4 mm x 6 m	30
23847	5 mm x 4 m	30



TRAKA ZA VEZANJE

Br.	specifikacija	
45472	3 cm x 3 m, 3 kom	36



TRAKA ZA VEZANJE

Br.	specifikacija	
45473	3 cm x 50 m	60

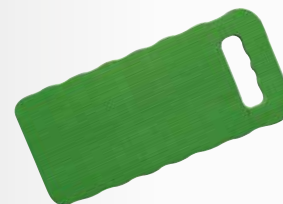

PODLOGA

Br.	specifikacija	
45086	40 x 18 x 2 cm	50



BAŠTENSKA SKLOPIVA
STOLICA

· Reverzibilni

Br.	specifikacija	
45074	58 x 48 x 28 cm	4



SKLOPLJIVA PLATNENA KORPA

Br.	specifikacija	
45093	40 x 25 x 23 cm	10



KANTA

MADE IN EU

Br.	specifikacija	
39192	26 l	20
39193	42 l	20



KANTA ZA LIŠČE SKLOPIVA

Br.	specifikacija	
45047	55 x 70 cm, 3 držalje	20



KESE ZA LIŠČE

Br.	specifikacija	
44960	200 l 60 x 60 x 55 cm	50



FESTA[®]
AQUATIC

FESTA[®]
AQUATIC

PIŠTOLJ
ZA PRSKANJE

- 7 funkcija
- front trigger with lock
- effortless flow control



Br. 45386 specifikacija 12

FESTA[®]
AQUATIC

PIŠTOLJ
ZA PRSKANJE

- adjustable flowing
- front trigger with lock
- effortless flow control



Br. 45388 specifikacija 12

FESTA[®]
AQUATIC

MLAZNICA

- adjustable flowing



Br. 45389 specifikacija 24



FESTA[®]
AQUATIC

KOMPLET
SA MLAZNICOM

- adjustable flowing



Br. 45385 specifikacija 4 kom 12

FESTA[®]
AQUATIC

SPOJNICA CREVO CREVO



Br. 45390 specifikacija 24

FESTA[®]
AQUATIC

SPOJNICA ČESMA CREVO



Br. 45392 specifikacija 24

FESTA[®]
AQUATIC

SPOJNICA ČESMA
CREVO STOP



Br. 45394 specifikacija 24

FESTA[®]
AQUATIC

SPOJNICA CREVO CREVO



Br. 45391 specifikacija 24

FESTA[®]
AQUATIC

SPOJNICA ČESMA CREVO



Br. 45393 specifikacija 24

FESTA[®]
AQUATIC

SPOJNICA ČESMA
CREVO STOP



Br. 45395 specifikacija 24

FESTA
AQUATIC
ADAPTER



Br.	specifikacija	
45396		24



NEW



FESTA
AQUATIC

CREVO ZA POLIVANJE
PROFI



Br.	specifikacija	
45372	1/2" 25 m	1
45373	1/2" 50 m	1
45374	3/4" 25 m	1
45375	3/4" 50 m	1
45376	1" 25 m	1
45377	1" 50 m	1



FESTA
AQUATIC
ADAPTER



Br.	specifikacija	
45397		24



FESTA
AQUATIC
PRSKALICA

· 19 nozzles with 8 switchable (on/off) spray nozzles



Br.	specifikacija	
45398		6

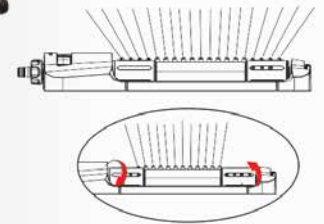

FESTA
AQUATIC
PRSKALICA

· adjustable arms with nozzles



Br.	specifikacija	
45399		12



FESTA
AQUATIC

RAZVODNIK

· podesivi protok vode



Br.	specifikacija	
45400		6



FESTA
AQUATIC

RAZVODNIK

· podesivi protok vode



Br.	specifikacija	
45401		6



ROSA

PIŠTOLJ
ZA PRSKANJE

- 10 funkcija
- front trigger with lock

0,7bar min
5,5bar max



Br. specifikacija



45124

12

ROSA

PIŠTOLJ
ZA PRSKANJE

- 10 funkcija
- trigger with lock
- podesivi protok vode

0,7bar min
5,5bar max



Br. specifikacija



45125

12

ROSA

Watering system



ROSA

PIŠTOLJ
ZA PRSKANJE

- 7 funkcija
- trigger with lock

0,7bar min
5,5bar max



Br. specifikacija



45126

12

ROSA

PIŠTOLJ
ZA PRSKANJE

- 7 funkcija
- trigger with lock
- podesivi protok vode

0,7bar min
5,5bar max



Br. specifikacija



45123

metal

12

ROSA

PIŠTOLJ
ZA PRSKANJE

- 6 funkcija
- trigger with lock
- podesivi protok vode

0,7bar min
5,5bar max



Br. specifikacija



45117

12

ROSA

PIŠTOLJ
ZA PRSKANJE

- 6 funkcija
- trigger with lock
- podesivi protok vode

0,7bar min
5,5bar max



Br. specifikacija



45118

metal head

12

ROSA

PIŠTOLJ
ZA PRSKANJE

- 5 funkcija
- trigger with lock
- podesivi protok vode

0,7bar min
5,5bar max



Br. specifikacija



45110

12

ROSA

PIŠTOLJ
ZA PRSKANJE

- Pištolj ruža
- podesivi protok vode

0,7bar min
5,5bar max



Br. specifikacija



45116

12

ROSA

PIŠTOLJ ZA PRSKANJE

- Metalni
- trigger with lock
- podesivi protok vode

0,7 bar min
5,5 bar max

Br. specifikacija
45120



12

ROSA

PIŠTOLJ ZA PRSKANJE

- Metalni
- trigger with lock
- podesivi protok vode

0,7 bar min
5,5 bar max

Br. specifikacija
45122 metalni



12

ROSA

PIŠTOLJ ZA PRSKANJE

- trigger with lock
- podesivi protok vode

0,7 bar min
5,5 bar max

Br. specifikacija
45111



12

ROSA

PRSKALICA

- adjustable flowing

10 bar max

1"

Br. specifikacija
45214



48

ROSA

MLAZNICA

- Klasičan spoj

0,7 bar min
5,5 bar max

Br. specifikacija
45112



1/2"
3/4"

32

ROSA

MLAZNICA

- adjustable flowing

0,7 bar min
5,5 bar max

Br. specifikacija
45113



60

ROSA

PIŠTOLJ ZA PRSKANJE

- trigger with lock
- podesivi protok vode

0,7 bar min
5,5 bar max

Br. specifikacija
45115



12

ROSA

PIŠTOLJ ZA PRSKANJE + SPOJNICA

- trigger with lock
- podesivi protok vode

0,7 bar min
5,5 bar max

1/2" 2x

Br. specifikacija
45114 1/2 brza spojnica



12

ROSA

KOMPLET SA PIŠTOLJEM

- 6 funkcija
- trigger with lock
- podesivi protok vode

0,7 bar min
5,5 bar max

1/2" 4x

Br. specifikacija
45181



12



ROSA

KOMPLET SA MLAZNICOM

- adjustable flowing

0,7 bar min
5,5 bar max

1/2" 4x

Br. specifikacija
45180



12

ROSA

SPOJNICA CREVO CREVO



Br. 45140 specifikacija 60

ROSA

SPOJNICA ČESMA CREVO



Br. 45142 specifikacija 60

ROSA

SPOJNICA ČESMA CREVO STOP



Br. 45138 specifikacija 60

ROSA

SPOJNICA CREVO CREVO



Br. 45296 specifikacija MOQ 20

ROSA

SPOJNICA ČESMA CREVO



Br. 45298 specifikacija MOQ 20

ROSA

SPOJNICA ČESMA CREVO STOP



Br. 45294 specifikacija MOQ 20

ROSA

SPOJNICA CREVO CREVO



Br. 45141 specifikacija 60

ROSA

SPOJNICA ČESMA CREVO



Br. 45143 specifikacija 60

ROSA

SPOJNICA ČESMA CREVO STOP



Br. 45139 specifikacija 60

ROSA

SPOJNICA CREVO CREVO



Br. 45297 specifikacija MOQ 20

ROSA

SPOJNICA ČESMA CREVO



Br. 45299 specifikacija MOQ 20

ROSA

SPOJNICA ČESMA CREVO STOP



Br. 45295 specifikacija MOQ 20

ROSA

SPOJNICA REDUCIR 1/2" - 3/4"



Br. 45213 specifikacija 60

ROSA

SPOJNICA REDUCIR 3/4" - 1"



Br. 45216 specifikacija 48

ROSA

SPOJNICA



Br. 45218 specifikacija 48

ROSA
ADAPTER



Br.	specifikacija	
45130	1/2" + 3/4"	60
45131	3/4" + 1"	60

ROSA
ADAPTER



Br.	specifikacija	
45217	1" + 3/4" + 1"	48

ROSA
SPOJNICA ČESMA CREVO



Br.	specifikacija	
45219	1"	48

ROSA
ADAPTER



Br.	specifikacija	
45289	1/2" + 3/4"	MOQ 20
45290	3/4" + 1"	MOQ 20

ROSA
SPOJNICA I ADAPTER

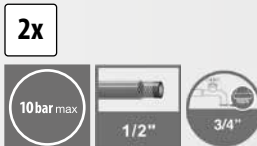

Br.	specifikacija	
45144	1/2" + 3/4"	60

ROSA
KONEKTOR SA VENTILOM
sa ventilom



Br.	specifikacija	
45135	3/4"	60

ROSA
ADAPTER
SA SPOLJNIM NAVOJEM



Br.	specifikacija	
45133	3/4"	60

ROSA
ADAPTER



Br.	specifikacija	
45132	3/4"	60

ROSA
SPOJNICA



Br.	specifikacija	
45136		60

ROSA
ADAPTER
SA SPOLJNIM NAVOJEM

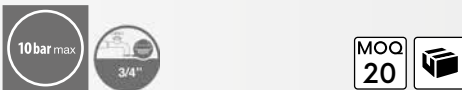

Br.	specifikacija	
45292	3/4"	MOQ 20

ROSA
ADAPTER

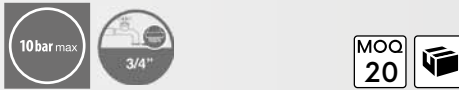

Br.	specifikacija	
45291	3/4"	MOQ 20

ROSA
SPOJNICA



Br.	specifikacija	
45293		MOQ 20

ROSA
SPOJNICA

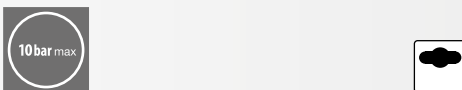

Br.	specifikacija	
45137		60

ROSA
SPOJNICA

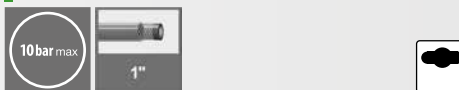

Br.	specifikacija	
45215	1"	48

ROSA
ADAPTER SA ŠELNOM



Br.	specifikacija	
45145	1/2"	60

ROSA

ROZDVOJKA - Y

- Sa ventilom

0,7 bar min
5,5 bar max

Br. 45134 specifikacija

12



ROSA

PRODAJNI SET

- Sadržaj kompleta:

45113 15 kom
45117 10 kom
45120 15 kom
45132 40 kom
45131 40 kom
45133 40 kom
45142 25 kom
45143 20 kom
45140 20 kom

225x

Br. 45146 specifikacija

1



ROSA

PRSKALICA

- Impulsna

0,7 bar min
5,5 bar max

Br. 45162 specifikacija

24



ROSA

PRSKALICA

- 8 funkcija

0,7 bar min
5,5 bar max

Br. 45154 specifikacija

48



ROSA

PRSKALICA

- Rotaciona
- 2 ramena

0,7 bar min
5,5 bar max

Br. 45153 specifikacija

24



ROSA

PRSKALICA

- Rotaciona
- 3 ramena

0,7 bar min
5,5 bar max

Br. 45152 specifikacija

24



ROSA

PRSKALICA ROTACIONA

- 17 rupa

0,7 bar min
5,5 bar max

ALU

Br. 45158 specifikacija

6

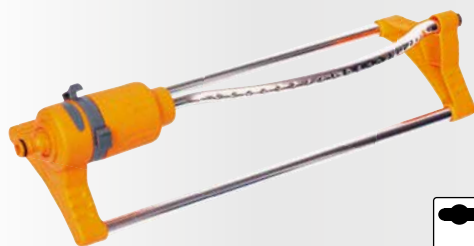

ROSA

PRSKALICA

- Piramida

0,7 bar min
5,5 bar max

Br. 45167 specifikacija

12



ROSA

POSTOLJE ZA IMPULSNU PRSKALICU

0,7 bar min
5,5 bar max

3/4"

Br. 45155 specifikacija

24



ROSA

PRSKALICA

- Sa stativom

0,7 bar min
5,5 bar max

Br. 45163 specifikacija
impuls na stativu

20



ROSA

PRSKALICA

· Ubodna

0,7 bar min
5,5 bar max

Br. 45160 specifikacija

25



ROSA

PRSKALICA SA VENTILOM

· Sa ventilom

0,7 bar min
5,5 bar max

Br. 45156 specifikacija

12



ROSA

TAIMER

· 0 - 120 min.

0,7 bar min
5,5 bar max

3/4"

Br. 45147 specifikacija

24



ROSA

PRSKALICA IMPULSNA

· Mesing

0,7 bar min
5,5 bar max

3/4"

Br. 45150 specifikacija

12



ROSA

PRSKALICA IMPULSNA

0,7 bar min
5,5 bar max

3/4"

Br. 45151 specifikacija

12



ROSA

PRSKALICA UBODNA MLAZNA

0,7 bar min
5,5 bar max

3/4"

Br. 45168 specifikacija

45169 Plastična 12

45169 Metalna 12



ROSA

PRSKALICA UBODNA IMPULSNA

0,7 bar min
5,5 bar max

Br. 45161 specifikacija

12 plastový hrot 20



ROSA

PRSKALICA UBODNA, ROTACIONA

· 3 ramena

· Dvosmerni

0,7 bar min
5,5 bar max

3/4"

Br. 45164 specifikacija

12 Plastična 12



ROSA

TELO PRSKALICE POC.

3/4" Zn

Br. 45159 specifikacija

12



ROSA

TELO PRSKALICE PLAST.

3/4"

Br. 45179 specifikacija

12



ROSA

USMERIVAC CREVA

Br. 45186 specifikacija

48



ROSA

PRSKALICA IMPULSNA METALNA

1"

Br. 45185 specifikacija

20



ROSA

PRSKALICA IMPULSNA METALNA

3/4"

Br. 45184 specifikacija

20



ROSA

SPOJNICA
CREVO CREVO
MSBr. specifikacija
45192 48

ROSA

SPOJNICA
ČESMA CREVO
MSBr. specifikacija
45194 48

ROSA

SPOJNICA
CREVO ČESMA
STOP MSBr. specifikacija
45190 48

ROSA

SPOJNICA
ČESMA CREVO
MSBr. specifikacija
45193 48

ROSA

SPOJNICA
ČESMA CREVO
MSBr. specifikacija
45195 48

ROSA

SPOJNICA
CREVO ČESMA
STOP MSBr. specifikacija
45191 48

ROSA

ADAPTER
MSBr. specifikacija
45196 Sa unutrašnjim navojem 1/2" + 3/4" 48

ROSA

ADAPTER
MSBr. specifikacija
45197 Sa unutrašnjim navojem 3/4" 48

ROSA

ADAPTER
MSBr. specifikacija
45199 Sa unutrašnjim navojem 1" 48

ROSA

ADAPTER
MSBr. specifikacija
45198 Sa unutrašnjim navojem 3/4" + 1" 48

ROSA

ADAPTER
MSBr. specifikacija
45200 Sa spoljnim navojem 3/4" 48

ROSA

PRSKALICA
MSBr. specifikacija
45206 Podesiva 48

ROSA

SPOJNICA
KLASIČNA
MSBr. specifikacija
45203 Spojnica za 2 creva 48

ROSA

SPOJNICA
KLASIČNA
MSBr. specifikacija
45204 Spojnica za 3 creva 48

SPOJNICA

Br. specifikacija
45211 unutrašnji navoj 1" 25

ROSA

KOMPLET DIHTUNGA

· Za artikal
45110, 45111, 45118, 45120, 45121, 45123,
45125, 45126, 45130, 45131, 45132, 45134,
45135, 45152, 45153, 45154, 45155, 45156,
45162, 45177, 45178, 45180, 45196, 45197,
45198

Br. specifikacija
45175 1

ROSA

DIHTUNZI
ZA SPOJNICE

50x

Br. specifikacija
45187 1

NEW



ROSA

CREVO ZA POLIVANJE
TRANSPARENTAN



Br.	specifikacija	
45342	1/2" 10 m	1
45343	1/2" 15 m	1
45344	1/2" 20 m	1
45345	1/2" 25 m	1
45346	1/2" 50 m	1
45341	3/4" 10 m	1
45347	3/4" 15 m	1
45348	3/4" 20 m	1
45349	3/4" 25 m	1
45351	3/4" 50 m	1
45352	1" 15 m	1
45353	1" 25 m	1
45354	1" 50 m	1

NEW



FESTA
AQUATIC

CREVO ZA POLIVANJE
PROFI



Br.	specifikacija	
45372	1/2" 25 m	1
45373	1/2" 50 m	1
45374	3/4" 25 m	1
45375	3/4" 50 m	1
45376	1" 25 m	1
45377	1" 50 m	1



ROSA

SPIRALNO CREVO SET



Br.	specifikacija	
45300	7,5 m	6
45301	15 m	8



ROSA

MOTALICA ZA CREVO



Br.	specifikacija	
45178	1/2" 60 m	5



ROSA

MOTALICA ZA CREVO
SA TOČKOM



Br.	specifikacija	
45183	1/2" 60 m	5



ROSA

MOTALICA ZA CREVO
SA TOČKOM



Br.	specifikacija	
45177	1/2" 60 m	5

ROSA

DRŽAČ
BAS. CREVA

Br.	specifikacija		
45182	1/2" 40 m	4	60



ROSA

CREVO ZA POLIVANJE
SA AUTOMATSKIM
VRAĆANJEM

• Uključujući crevo 1/2" 20 m



Br.	specifikacija		
45176		1	60



ROSA

DRŽAČ BAS. CREVA

Br.	specifikacija	
45174		60



NOSAČ CREVA

• Max nosivost 30m creva 1/2"

Br.	specifikacija	
45350	Max. nosivost 20 kg	1



SPOJNICA CREVA
KLASIČNA

Br.	specifikacija	
45220	1/2" navoj 3/4"	10
45221	3/4" navoj 1"	10
45222	1" navoj 1"	10



ADAPTER

Br.	specifikacija	
45223	1/2" navoj 3/4"	10
45224	3/4" navoj 1"	10
45225	1" navoj 1"	10

REDUCIR
ZA BAS. CREVO

Br.	specifikacija	
45226	1/2" - 3/4" zavit 1"	10
45227	1" - 3/4" zavit 1"	10
45228	1" - 1/2" zavit 1"	10

MLAZNICA
ZA CREVO

Br.	specifikacija	
45229		10



Br.	Prečnika	
45603	16 - 25 mm	2
45604	20 - 32 mm	2
45605	25 - 40 mm	2
45606	30 - 45 mm	2
45607	32 - 50 mm	2
45608	40 - 60 mm	2
45609	50 - 70 mm	2
45610	60 - 80 mm	2
45611	70 - 90 mm	2
45612	80 - 100 mm	2
45613	90 - 110 mm	2
45614	100 - 120 mm	2
45615	110 - 130 mm	2
45616	120 - 140 mm	2
45617	130 - 150 mm	2
45618	140 - 160 mm	2
45619	150 - 170 mm	2



Br.	Prečnika	Širina	
45623	16 - 25 mm	9 mm	2
45624	20 - 32 mm	9 mm	2
45625	25 - 40 mm	12 mm	2
45626	30 - 45 mm	12 mm	2
45627	32 - 50 mm	12 mm	2
45628	40 - 60 mm	12 mm	2
45629	50 - 70 mm	12 mm	2
45630	60 - 80 mm	12 mm	2
45631	70 - 90 mm	12 mm	2
45632	80 - 100 mm	12 mm	2
45633	90 - 110 mm	12 mm	2
45634	100 - 120 mm	12 mm	2
45635	110 - 130 mm	12 mm	2
45636	120 - 140 mm	12 mm	2
45637	130 - 150 mm	12 mm	2
45638	140 - 160 mm	12 mm	2
45639	150 - 170 mm	12 mm	2

ŠELNA POCINKOVANA

Zn

MOQ
2

Br.	Prečnika	
45600	8 - 12 mm	2
45601	10 - 16 mm	2
45602	12 - 20 mm	2

ŠELNA NERĐAJUĆA

INOX

MOQ
2

Br.	Prečnika	Širina	
45620	8 - 12 mm	9 mm	2
45621	10 - 16 mm	9 mm	2
45622	12 - 20 mm	9 mm	2

SLAVINA KUGLA

Br.	
45105	8



SLAVINA KUGLA

Br.	specifikacija	
45100	1/2"	12
45101	3/4"	10
45102	1"	6



KUGLA VENTIL

Br.	specifikacija	
45106	1/2"	12
45107	3/4"	10
45108	1"	8

KANTA
PLASTIČNAMADE IN
EU

Br.	specifikacija	
45280	2,5 l	10
45283	5 l	10
45285	10 l	10
45286	12 l	10
45287	15 l	10



VENTIL UGAONI

Br.	specifikacija	
45104	1/2" x 3/8"	10





FESTA

**RUČNI PERAČ
POD PRITISKOM 12L**

Max pritisak	2,5 Bar
Kapacitet	12 l
Dužina creva	3 m
Mere	32 x 25 x 59 cm



Br.	specifikacija	
45249	ručni perač pod pritiskom 12 l	1

FESTA

PRSKALICA SA PRITISKOM

Br.	specifikacija	
45247	12 l	1
45248	16 l	1

Br.	specifikacija	
45263	Rezervno crevo za prskalicu	1
45251	Rezervni komplet brtvljenja	1
45254	Rezervna plastična mlaznica	1
45257	Plastična drška	1
45261	Rezervni štap - 370 mm	1
45267	Rezervni štap 45 - 250 cm	1
45268	Rezervni štap 65 - 260 cm	1



FESTA

PRSKALICA SA PRITISKOM

Br.	specifikacija	
45244	3 l	6
45245	5 l	6
45246	8 l	6

Br.	specifikacija	
45262	Rezervno crevo za prskalicu	1
45250	Rezervni komplet brtvljenja	1
45253	Rezervna plastična mlaznica	1
45256	Plastična drška	1
45260	Rezervni štap - 370 mm	1



• Za prskalicu: 45244, 45245, 45246



• Za prskalicu: 45247, 45248

93 - 250 cm



ŠTAP ZA PRSKALICU

Br.	typ	
45267	45 - 250 cm	inox 1
45268	65 - 260 cm	fiberglass 1

ŠTAP ZA PRSKALICU

Br.	specifikacija	
45269		1



REZERVNO CREVO ZA PRSKALICU

Br.	typ	
45263	Za prskalicu 45247, 45248	1
45262	Za prskalicu 45244, 45245, 45246	1



ZVONO ZA PRSKANJE

Br.	velikost	Dužina	Širina	visina	
45265	small	230 mm	90 mm	130 mm	1
45266	big	370 mm	140 mm	200 mm	1



FESTA

PRSKALICA SA PRITISKOM



Br.	typ	
45242	1,5 l	20
45241	2 l	20

PRSKALICA FAJTALICA



Br.	typ	
45239	0,5 l	1
45240	0,7 l	1



ROSA

TUŠ BAŠTENSKI 1 NOGA



Br.	specifikacija	
45171	Podesiva	12



ROSA

TUŠ BAŠTENSKI 3 NOGE



Br.	specifikacija	
45170	3 noge	6



ROSA

TUŠ RUČNI SA VENTILOM



Br.	specifikacija	
45172	Sa ventilom	12
45173	10 funkcija	12



FESTA[®]

system click
ON - OFF

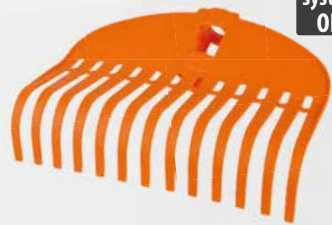

system click
ON - OFF

FESTA

GRABLJE METLICA

Br.	Broj letvica	Širina	visina	
45327	13	240 mm	200 mm	12



system click
ON - OFF

FESTA

GRABLJE PLASTIČNE

Br.	Broj letvica	Širina	
45325	12	410 mm	12



system click
ON - OFF

FESTA

GRABLJE METLICA

Br.	Broj letvica	Širina	visina	
45328	23	480 mm	280 mm	12



system click
ON - OFF

FESTA

GRABLJE PLASTIČNE

Br.	Broj letvica	Širina	
45326	18	580 mm	12



system click
ON - OFF

FESTA

GRABLJE METLICA

Br.	Broj letvica	Širina	visina	
45329	35	760 mm	310 mm	1



system click
ON - OFF

FESTA

PAJALICA

Br.	specifikacija	
45323	37 cm	16

FESTA

DRŽALO ZA GRABLJE

ALU



system click
ON - OFF

Br.	specifikacija	
45330	161 cm	24
45331	100 cm	24

**FESTA**

GRABLJE METLICE
TELESKOP
PODESIVE



Zn

Br.	Broj letvica	rozsah	
44965	15	200 - 590 mm	12

GRABLJE METLICE PODESIVE



Zn

Br.	Broj letvica	vaha	rozsah	
45050	15	1200 g	200 - 590 mm	25

FESTA

GRABLJE - METLICA

· Opružni čelik

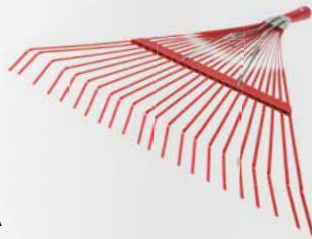

Br.	Širina	Broj letvica	
45071	55 cm	22	1

FESTA

GRABLJE - METLICA
SA DRVENOM
DRŠKOM

MOQ
3

Br.	Širina	Dužina drške	
61150	55 cm	160 cm	3



GRABLJE - METLICA

Br.	Širina	Broj letvica	
45051	40 cm	22	60

GRABLJE - METLICA
SA DRVENOM
DRŠKOM

MOQ
3

Br.	Širina	Dužina drške	
61130	40 cm	160 cm	3



GRABLJE - METLICA

Br.	Širina	Broj letvica	
45052	45 cm	22	36

GRABLJE - METLICA
SA DRVENOM
DRŠKOM

MOQ
3

Br.	Širina	Dužina drške	
61131	45 cm	160 cm	3

GRABLJE
METLIČA



Br.	Širina	Broj letvica	
45320	60 cm	24	10

GRABLJE - METLIČA
SA DRVENOM DRŠKOM



Br.	Širina	Broj letvica	Dužina drške	
61132	60 cm	24	160 cm	3



GRABLJE
METLIČA



Br.	Širina	Broj letvica	
45055	50 cm	22	10

GRABLJE - METLIČA
SA DRVENOM DRŠKOM



Br.	Širina	Broj letvica	Dužina drške	
61133	50 cm	22	160 cm	3



GRABLJE
METLIČA



Br.	Širina	Broj letvica	
45321	40 cm	23	20

GRABLJE - METLIČA
SA DRVENOM DRŠKOM



Br.	Broj letvica	Dužina drške	
61134	23	160 cm	3



GRABLJE
METLIČA



Br.	Širina	Broj letvica	
45054	40 cm	23	10

GRABLJE - METLIČA
SA DRVENOM DRŠKOM



Br.	Širina	Broj letvica	Dužina drške	
61135	40 cm	23	160 cm	3



GRABLJE



Br.	Širina	Broj letvica	
45053	58 cm	16	35

GRABLJE
SA DRVENOM DRŠKOM



Br.	Širina	Broj letvica	Dužina drške	
61141	58 cm	16	160 cm	3



GRABLJE



Br.	Širina	Broj letvica	
45070	41 cm	14	4

GRABLJE
SA DRVENOM
DRŠKOM

Br.	Širina	Broj letvica	Dužina drške	
61142	41 cm	14	160 cm	3



GRABLJE



Br.	Širina	Broj letvica	
61030	24 cm	10	24
61031	29 cm	12	24
61032	34 cm	14	24
61033	40 cm	16	24

GRABLJE
SA DRVENOM
DRŠKOM

Br.	Širina	Broj letvica	Dužina drške	
61060	24 cm	10	160 cm	3
61061	29 cm	12	160 cm	3
61062	34 cm	14	160 cm	3
61063	40 cm	16	160 cm	3



GRABLJE



Boja čekića

Br.	Širina	Broj letvica	
61045	30 cm	12	25
61046	39 cm	14	25
61047	45 cm	16	25

GRABLJE
SA DRVENOM
DRŠKOM

Boja čekića

Br.	Širina	Broj letvica	Dužina drške	
61143	30 cm	12	160 cm	3
61144	39 cm	14	160 cm	3
61145	45 cm	16	160 cm	3



GRABLJE



Br.	Širina	Broj letvica	
61048	35 cm	11 21	12

GRABLJE
SA DRŠKOM

Br.	Širina	Broj letvica	Dužina drške	
61146	35 cm	11 21	160 cm	3

GRABLJE
FIBERGLASS
DRŠKA

Br.	Širina	Broj letvica	Dužina drške	
61034	34 cm	14	160 cm	3



FESTA

AŠOV



Br.	specifikacija	Dužina drške	
61006	19 x 28 cm	120 cm	5

FESTA

AŠOV



• Pogodan za stakleničke radove

Br.	specifikacija	Dužina drške	
61008	19 x 28 cm	85 cm	5

FESTA

AŠOV



Br.	specifikacija	Dužina drške	
61005	20 x 29 cm	120 cm	5

FESTA



FESTA

AŠOV

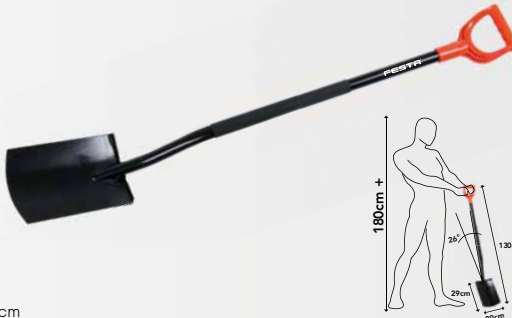

• Za osobu veću od 180 cm

Br.	specifikacija	Dužina drške	
61157	20 x 29 cm	130 cm	5

FESTA

AŠOV

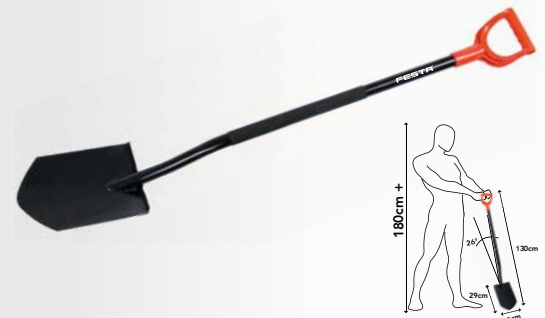

Br.	specifikacija	Dužina drške	
61158	19 x 28 cm	130 cm	5

FESTA

LOPATA
STANDARD



Br.	specifikacija	Dužina drške	
61155	24 x 29 cm	120 cm	5

FESTA

VILE



Br.	specifikacija	Dužina drške	
61156	19 x 28 cm	130 cm	5

FESTA

VILE



Br.	specifikacija	Dužina drške	
61007	18 x 28 cm	130 cm	5

VILE



Br.	specifikacija	Dužina drške	
61010	18 x 30 cm	95 cm	12

AŠOV



Br.	specifikacija	Dužina drške	
61029	19 x 30 cm	105 cm	12

AŠOV



Br.	specifikacija	Dužina drške	
61015	19 x 30 cm	105 cm	12



LOPATA ALUMINIJUMSKA

· Drška bukva

ALU

MOQ
3

Br.	specifikacija	Dužina drške	
61057	26 x 29 cm	130 cm	3
61056	34 x 30 cm	130 cm	3



LOPATA ALUMINIJUMSKA

ALU

Br.	specifikacija	
61026	26 x 29 cm	10
61025	34 x 30 cm	10



LOPATA ZA UGALJ

MOQ
3

Br.	specifikacija	Dužina drške	
61089	35 x 35 cm	130 cm	3



LOPATA ZA UGALJ

Br.	specifikacija	
61021	35 x 35 cm	10



LOPATA ŠPICASTA

· Boja čekića
· Drška bukva

MOQ
3

Br.	specifikacija	Dužina drške	
61050	26 x 28 cm	130 cm	3



LOPATA ŠPICASTA

· Boja čekića

Br.	specifikacija	
61000	26 x 28 cm	12



LOPATA ŠPICASTA

· Drška bukva

MOQ
3

Br.	specifikacija	Dužina drške	
61088	26 x 28 cm	130 cm	3



LOPATA ŠPICASTA

Br.	specifikacija	
61020	26 x 28 cm	12



LOPATA STANDARD

· Boja čekića
· Drška bukva

MOQ
3

Br.	specifikacija	Dužina drške	
61051	24 x 29 cm	130 cm	3



LOPATA STANDARD

· Boja čekića

Br.	specifikacija	
61001	24 x 29 cm	12





LOPATA STANDARD

Br.	specifikacija	
61022	24 x 29 cm	12



LOPATA STANDARD

• Drška bukva

MOQ
3

Br.	specifikacija	Dužina drške	
61090	24 x 29 cm	130 cm	3
61053	24 x 29 cm	130 cm "T", Drška	3



LOPATA

Br.	specifikacija	
61058	25 x 27 cm	12



LOPATA

• Drška bukva

MOQ
3

Br.	specifikacija	Dužina drške	
61059	25 x 27 cm	130 cm	3



LOPATA USKA

• Boja čekića

Br.	specifikacija	
61002	19 x 27 cm	12



LOPATA USKA

• Boja čekića
• Drška bukva

MOQ
3

Br.	specifikacija	Dužina drške	
61052	19 x 27 cm	130 cm	3



LOPATA USKA

Br.	specifikacija	
61024	19 x 27 cm	12



LOPATA USKA

Br.	specifikacija	Dužina drške	
61054	19 x 27 cm	130 cm	3



LOPATA PLASTIČNA

Br.	specifikacija	
61027	24 x 26 cm	12



AŠOV

· Boja čekića

MOQ
3

Br.	specifikacija	Dužina drške	
61161	22 x 30 cm	90 cm	3



AŠOV

· Boja čekića

Br.	specifikacija	
61004	22 x 30 cm	12



AŠOV

MOQ
3

Br.	specifikacija	Dužina drške	
61097	19 x 30 cm	90 cm	3



AŠOV

Br.	specifikacija	
61019	22 x 30 cm	12



AŠOV KOVANI

Br.	specifikacija	Dužina drške	MOQ
61162	22 x 25 cm	90 cm	3
61223	drška	90 cm	1



AŠOV KOVANI

Br.	specifikacija	
61013	22 x 25 cm	12



AŠOV

· Boja čekića

MOQ
3

Br.	specifikacija	Dužina drške	
61163	21 x 30 cm	90 cm	3



AŠOV

· Boja čekića

Br.	specifikacija	
61003	21 x 30 cm	12



AŠOV

Br.	specifikacija	
61018	21 x 30 cm	12



AŠOV

MOQ 3

Br.	specifikacija	Dužina drške	
61098	21 x 30 cm	90 cm	3



AŠOV

Br.	specifikacija	
61014	14 x 37 cm	12



AŠOV

Br.	specifikacija	Dužina drške	
61164	14 x 37 cm	90 cm	MOQ 3
61203	drška	90 cm	1



VILE

Br.	specifikacija	
61009	20 x 32 cm	12



VILE

MOQ 3

Br.	specifikacija	Dužina drške	
61165	20 x 32 cm	90 cm	3



KOVANA VILA

Br.	specifikacija	
61012	22 x 30 cm	12



KOVANA VILA

Br.	specifikacija	Dužina drške	
61166	22 x 30 cm	90 cm	MOQ 3
61222	drška	90 cm	1



VILE

Br.	specifikacija	
61044	20 x 30 cm	12



VILE

Br.	specifikacija	Dužina drške	
61028	20 x 30 cm	90 cm	MOQ 3
61209	drška	90 cm	1



MOTIKA KOVANA ŠPICASTA

Br.	specifikacija	Dužina drške	MOQ	
61111	0,4 kg	120 cm	3	
61112	0,6 kg	120 cm	3	
61224	drška	120 cm	1	



MOTIKA KOVANA ČETVRTASTA SA DRŠKOM

Br.	specifikacija	Dužina drške	MOQ	
61114	0,6 kg	120 cm	3	
61224	drška	120 cm	1	



MOTIKA

MOQ
3

Br.	specifikacija	Dužina drške	MOQ	
61290	75 mm	120 cm	3	
61291	125 mm	120 cm	3	
61292	175 mm	120 cm	3	



MOTIKA

MOQ
3

Br.	specifikacija	Dužina drške	MOQ	
61293	140 mm	120 cm	3	



KRAMP

MOQ
3

Br.	specifikacija	Dužina drške	MOQ	
61121	1,5 kg	95 cm	3	
61042	2,5 kg	95 cm	3	

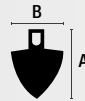

MOTIKA KOVANA ŠPICASTA

Br.	specifikacija	A	B	MOQ	
61035	0,4 kg	180 mm	125 mm	1	
61036	0,6 kg	230 mm	160 mm	30	

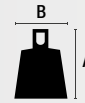

MOTIKA KOVANA ČETVRTASTA

Br.	specifikacija	A	B	MOQ	
61038	0,6 kg	165 mm	135 mm	20	



MOTIKA

Br.	specifikacija	MOQ	
61067	75 mm	1	
61068	125 mm	1	
61069	175 mm	1	



MOTIKA

Br.	specifikacija	MOQ	
61070	140 mm	40	



KRAMP

Br.	specifikacija	MOQ	
61120	1,5 kg	6	
61040	2,5 kg	6	



FESTA

LOPATA ZA SNEG



Br.	specifikacija	
60006	46 x 34 cm	12
60206	46 x 34 cm, Sastavljeni	1

FESTA

LOPATA ZA SNEG



Br.	specifikacija	
60008	50 x 34 cm	12
60208	50 x 34 cm, Sastavljeni	1

LOPATA ZA SNEG



MADE IN EU

Br.	specifikacija	
60001	48 x 40 cm	10
60201	48 x 40 cm, Sastavljeni	1

LOPATA ZA SNEG



ALU

Br.	specifikacija	
60012	50 x 38 cm	12
60212	50 x 38 cm, Sastavljeni	1



STRUGAČ ZA LED

Br.	specifikacija		MOQ
60022	20 cm	3	3

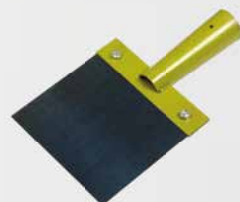

STRUGALICA ZA LED

Br.	specifikacija	
60018	15 cm	20
60019	20 cm	24
60020	30 cm	20
61201	držka 130 cm	10



SOL PROTIV ZAMRZAVANJA

Br.	specifikacija	
43300	10 kg	1
43301	25 kg	1



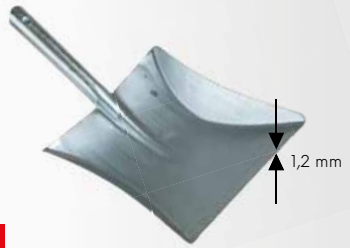

FESTA

LOPATA

Br.	specifikacija	24
52176	22 x 23 cm	

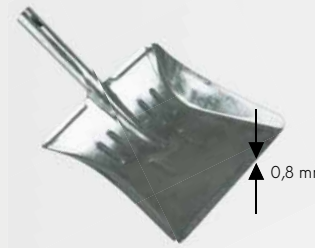

LOPATA

Zn

Br.	specifikacija	50
52175	22 x 23 cm	



ČETKA SA LOPATICOM

MADE IN EU

Br.	specifikacija	26
52168		



ČETKA SA LOPATICOM

MADE IN EU

Br.	specifikacija	26
52173		



ČEL. ČETKA ZA ČIŠĆENJE PLOČNIKA

Br.	Dužina drške	1
52198	140 cm	



ČETKA

MADE IN EU

Br.	specifikacija	24
52119	29 cm	



ČETKA SA NASADOM

MADE IN EU

Br.	specifikacija	3
52197	30 cm 120 cm Drvena	



PAJALICA

MADE IN EU

Br.	specifikacija	25
52108	30 cm Sa navojem	
61172	drška 120 cm Sa navojem	1



ČETKA SA NASADOM

Br.	specifikacija	1
52135	145 cm 5x prošiveno	



FESTA

PAJALICA

Br.	specifikacija	16
45323	37 cm	





PAJALICA



Br.	specifikacija	
52101	30 cm	10
52102	40 cm	10
52103	50 cm	10
52104	60 cm	10
52105	80 cm	10



PAJALICA



Br.	specifikacija	Dužina drške	
52190	30 cm	150 cm	3
52191	40 cm	150 cm	3
52192	50 cm	150 cm	3
52193	60 cm	150 cm	3
52194	80 cm	150 cm	3



PAJALICA



Br.	specifikacija	
52160	40 cm	10
52161	50 cm	10
52162	60 cm	10
52163	70 cm	10
52164	80 cm	10



PAJALICA



Br.	specifikacija	Dužina drške	
52185	40 cm	150 cm	3
52186	50 cm	150 cm	3
52187	60 cm	150 cm	3
52188	70 cm	150 cm	3
52189	80 cm	150 cm	3



PAJALICA



Br.	specifikacija	
52114	28 cm Sa navojem	1



ČETKA SA NASADOM



Br.	specifikacija	Dužina drške	
52116	28 cm	130 cm	3



ČETKA



Br.	specifikacija	
52113	30 cm Sa navojem	26
52115	30 cm Bez navoja	26



ČETKA SA NASADOM



Br.	specifikacija	Dužina drške	
52195	30 cm	150 cm Drvena	3
52196	30 cm	130 cm ALU	3



SPAHLA SA GUMOM

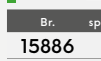

Br.	specifikacija	
15886	450 mm Držalje Ø 23 mm	48
15887	600 mm Držalje Ø 23 mm	48
15888	750 mm Držalje Ø 23 mm	32



ČETKA SA NASADOM



Br.	specifikacija	
52109	25 cm 120 cm Drvena	12

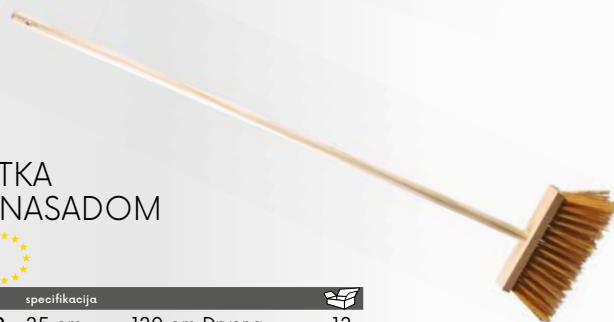



FESTA METLA ŽIČANA

Br.	specifikacija		
22135	6 x 19 cm	wihout handle	8
22137	6 x 19 cm	with handle 140 cm	MOQ 3



FESTA METLA PVC

Br.	specifikacija		
22136	6 x 19 cm	wihout handle	8
22138	6 x 19 cm	with handle 140 cm	MOQ 3



MOP-ZOGER

Br.	specifikacija	
52110	30 cm	16



MOP-ZOGER

Br.	specifikacija	
52111	30 cm	1



FESTA DRŽALO ZA GRABLJE

Br.	specifikacija	
45330	161 cm	24
45331	100 cm	24

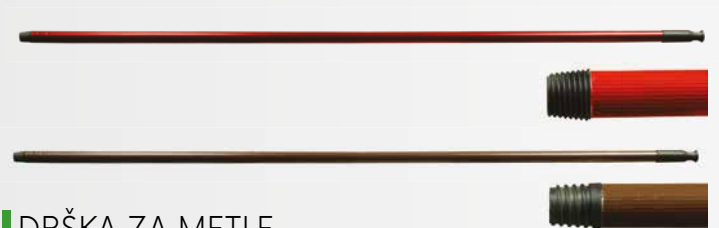

DRŠKA ZA METLE

Br.	specifikacija	
52126	130 cm, sa navojem	1

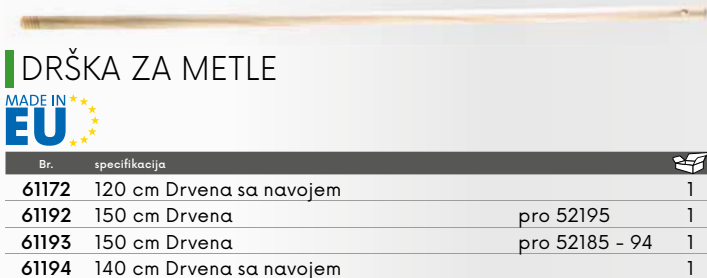

DRŠKA ZA METLE

Br.	specifikacija	
61172	120 cm Drvena sa navojem	1
61192	150 cm Drvena	pro 52195 1
61193	150 cm Drvena	pro 52185 - 94 1
61194	140 cm Drvena sa navojem	1



DRŠKA ZA METLE

Br.	specifikacija		Br.	specifikacija	
61171	1,2 m	1	61175	1,6 m	1
61173	1,4 m	1	61176	1,7 m	1
61174	1,5 m	1	61177	1,8 m	1



DRŽALO ZA LOPATU I VILE

Br.	specifikacija	
61200	130 cm	10



DRŽALO ZA LOPATU RAVNO

Br.	specifikacija	
61201	130 cm, rovná	10



DRŽALO ZA AŠOV

Br.	specifikacija	
61208	90 cm	10



DRŽALO ZA LOPATU T RAVNO

Br.	specifikacija	
61202	130 cm, rovná	10

DRŽALO ZA FANGLU



Br.	specifikacija	
61215	160 cm	10

DRŽALO ZA KRAMP



Br.	specifikacija	
61204	95 cm, uska (pro 61120)	10
61205	95 cm	10

DRŽALO ZA GRABLJE



Br.	specifikacija	
61195	120 cm	10

DRŽALO ZA GRABLJE



Br.	specifikacija	vhodné pro	
61250	160 cm	45051, 61048	20
61251	160 cm	45052	20
61252	160 cm	45320	20
61253	160 cm	45053	20
61254	160 cm	45054	20
61255	160 cm	45070	20
61256	160 cm	45055	20



DRŽALJE ZA MOTIKU SA PLAST. T RUKOHVATOM



Br.	specifikacija	
61207	100 cm	10

DRŽALO ZA MOTIKU



Br.	specifikacija	
61219	120 cm	10

DRŽALO ZA GRABLJE



Br.	specifikacija	
61183	150 cm	10
61184	160 cm	10
61189	170 cm	10
61190	180 cm	10



PLASTIČNI RUKOHVAT Y ZA DRŽALA

Br.	specifikacija	
61230		10

61079



120 cm

80 cm

Br.	
61005	15
61006	15
61050	15
61051	15
61052	15
61079	1
61097	15
61098	15

61077



• ilustrativna fotografija

REKLAMNA POLICA ZA LOPATE I AŠOVE

Br.	specifikacija	
61077	stalak sa lopatama, lopatama	1
61079	postolje sa paletom	1

DRŽAČ ZA BAŠTENSKI ALAT



Br.	specifikacija	
51184		12



• Rotirajuće gumene valjke



DRŽAČ ZA BAŠTENSKI ALAT

Br.	specifikacija	
51185	45 cm	15



Illustration photo



MREŽA PROTIV KOMARACA

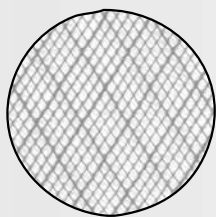

Br.	specifikacija	
40100	1 x 25 m - PE beli	1
40120	1,2 x 25 m - PE beli	1

KOMARNIK

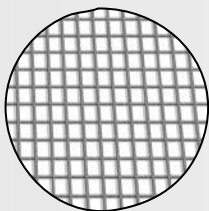

ALU **Zn**

Br.	specifikacija	
42101	1 x 30 m - ALUMINIUM	2
42103	1 x 30 m - Galvanizirana	2

KOMARNIK

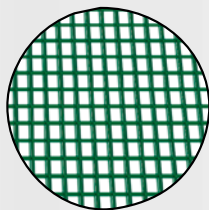

Br.	specifikacija	
42102	1x30 m - Zeleno lakirana	2

KOMARNIK FIBERGLASS

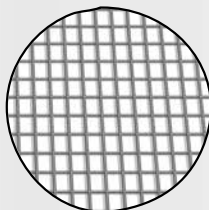

Br.	specifikacija		
41083	0,8 x 30 m	Beli	6
41103	1 x 30 m	Beli	6
41123	1,2 x 30 m	Beli	6
41153	1,5 x 30 m	Beli	6

Br.	specifikacija		
41082	0,8 x 30 m	Beli-sivi	6
41102	1 x 30 m	Beli-sivi	6
41122	1,2 x 30 m	Beli-sivi	6
41152	1,5 x 30 m	Beli-sivi	6

Br.	specifikacija		
41050	0,5 x 30 m	Sivi	6
41080	0,8 x 30 m	Sivi	6
41100	1 x 30 m	Sivi	6
41120	1,2 x 30 m	Sivi	6
41150	1,5 x 30 m	Sivi	6

Br.	specifikacija		
41081	0,8 x 30 m	Crni	6
41101	1 x 30 m	Crni	6
41121	1,2 x 30 m	Crni	6
41151	1,5 x 30 m	Crni	6





MREŽA PROTIV KOMARACA - BELI



Br.	specifikacija		
40050	150 x 130 cm	5,6 m	10
40052	150 x 180 cm	6,6 m	10
40054	150 x 90 cm	4,8 m	10
40056	220 x 75 cm 2 kom	5,8 m	10



MREŽA PROTIV KOMARACA - SIVI



Br.	specifikacija		
40051	150 x 130 cm	5,6 m	10
40053	150 x 180 cm	6,6 m	10
40055	150 x 90 cm	4,8 m	10



MREŽA PROTIV KOMARACA - CRNI



Br.	specifikacija		
40057	150 x 130 cm	5,6 m	10
40058	150 x 180 cm	6,6 m	10
40059	150 x 90 cm	4,8 m	10



ČIČAK TRAKA

Br.	specifikacija	
40060	9 mm 7 m	1

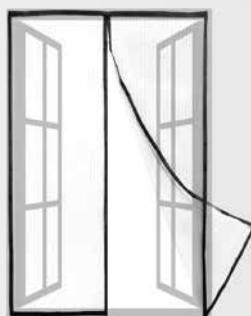

ZAVESNA NA VRATIMA PROTIV INSEKATA MAGNETNI - ANTRACIT



Br.	Specifikacija	
40077	100 x 220 cm	1



ZAVESA

· Promenjiva veličina 60 - 120 cm

Br.	specifikacija		
40075	4 x 35 x 220 cm	Beli	20
40076	4 x 35 x 220 cm	Crni	20

HEKOMEGON PLETIVO ZN

Zn



Br.	specifikacija	
42150	13 0,7 x 1000 mm - 50 m	1
42151	16 0,7 x 1000 mm - 50 m	1
42152	20 0,7 x 1000 mm - 50 m	1
42153	25 0,8 x 1000 mm - 50 m	1

HEKOMEGON PLETIVO ZN

Zn



Br.	specifikacija	
42155	13 0,7 x 1000 mm - 50 m	1
42156	16 0,7 x 1000 mm - 50 m	1
42157	20 0,7 x 1000 mm - 50 m	1
42158	25 0,8 x 1000 mm - 50 m	1

HEKOMEGON PLETIVO PVC

Zn



Br.	specifikacija	
42160	13 1 x 1000 mm - 25 m	1
42161	16 1 x 1000 mm - 25 m	1
42162	20 1 x 1000 mm - 25 m	1
42163	25 1 x 1000 mm - 25 m	1

PLETIVO PLASTIČNI



Br.	OKO	Ø žice	visina	length	
42175	15 x 9 mm	2 mm	40 cm	25 m	1
42176	15 x 9 mm	2 mm	65 cm	25 m	1
42177	15 x 9 mm	2 mm	90 cm	25 m	1
42178	15 x 9 mm	2 mm	120 cm	25 m	1
42179	15 x 9 mm	2 mm	25 cm	25 m	1



RABIC PUNKTOVAN

140
g/m²

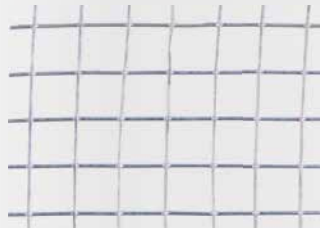

Br.	specifikacija	Br.	specifikacija
42185	6 0,65 x 1000 mm - 25 m	42174	25 1,4 x 1000 mm - 25 m
42170	10 0,8 x 100 mm - 25 m	42186	13 1,05 x 1000 mm - 25 m
42171	13 0,8 x 1000 mm - 25 m	42187	25 2,0 x 1000 mm - 25 m
42172	16 1,2 x 1000 mm - 25 m	42188	50 2,0 x 1000 mm - 25 m
42173	19 1,4 x 1000 mm - 25 m		

RABIC PUNKTOVAN PVC

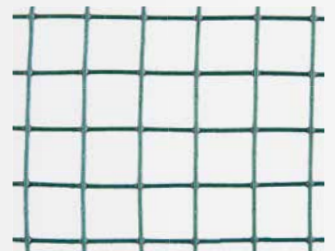

Br.	specifikacija	
42180	13 1,2 x 1000 mm - 25 m	1
42181	16 1,2 x 1000 mm - 25 m	1
42182	25 2,3 x 1000 mm - 25 m	1

MREŽA PROTIV PTICA

MADE IN
EU



Br.	specifikacija	
45570	2 x 5 m 18 x 18 mm	45
45571	2 x 10 m 18 x 18 mm	28
45572	4 x 5 m 18 x 18 mm	24
45573	4 x 10 m 18 x 18 mm	15

SIGURNOSNA OGRADA

140
g/m²

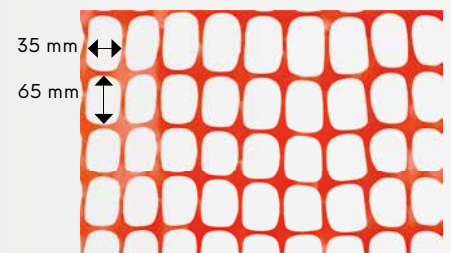

Br.	specifikacija	
42190	1,2 x 50 m HDPE 140g/m ²	1

PLETIVO RABICO

Zn



Br.	specifikacija	
42312	1 m 50 bm, 16 x 16 mm	1

ZAŠTITNA MREŽA ZA DRVEĆE

Sa samozatvaranjem

3x



Br.	specifikacija	
45580	Ø 11 x 80 cm	1



ŽICA ZN

Zn

Br.	Ø žice	Dužina žice	
42203	0,6 mm	30 m	50



ŽICA ZELENA PVC

Br.	Ø žice	Dužina žice	Površina	
42201	0,6 mm	30 m	PVC	50
42202	0,9 mm	30 m	PVC	50



BODLJIKAVA ŽICA

Zn

Br.	Ø žice	Dužina žice	
42260	1,7 mm	50 m	1
42261	1,7 mm	100 m	1



ZATEZAČ ZA OGRADE

Br.	specifikacija	
50035	2 t	6
50036	4 t	4



ZATEZAČ ŽIČANE OGRADE

Zn

Br.	specifikacija	
50030	Mali Zn presvučen	50
50032	Mali PVC presvučen	50

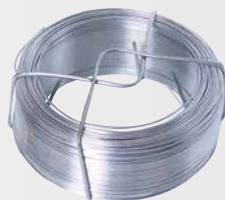

ŽICA

Zn

Br.	Ø žice	Dužina žice	
42207	0,8 mm	50 m	40
42208	0,8 mm	100 m	20
42209	0,9 mm	100 m	20
42240	1,0 mm	50 m	40
42210	1,0 mm	100 m	20
42211	1,2 mm	50 m	40
42212	1,2 mm	100 m	20
42213	1,4 mm	30 m	40
42214	1,4 mm	50 m	20
42217	1,8 mm	30 m	40
42218	1,8 mm	50 m	20



ŽICA PLASTIČNI

Br.	Ø žice	Dužina žice	
42244	1,4 mm	50 m	20
42248	1,8 mm	50 m	20
42249	2,0 mm	50 m	20



ZATEZAČ ŽICE

INOX

Br.	specifikacija	
50040	Nerđajući kraj - Zelena	50
50041	Nerđajući kraj - Crna	50



ZATEZAČ ŽIČANE OGRADE

Zn

Br.	specifikacija	
50031	Veliki Zn presvučen	50
50033	Veliki PVC presvučen	50



ŽICA

Zn

Br.	Ø žice	Dužina žice	
42219	2,0 mm	26 m	20
42220	2,0 mm	52 m	20
42221	2,0 mm	78 m	20
42228	3,15 mm	26 m	10
42229	3,15 mm	52 m	10
42230	3,15 mm	78 m	10



ŽICA PLASTIČNI

Br.	Ø žice	Dužina žice	
42251	2,6 mm	26 m	20
42252	2,6 mm	52 m	20
42253	2,6 mm	78 m	20
42255	3,4 mm	26 m	10
42256	3,4 mm	52 m	10
42257	3,4 mm	78 m	10



ZATEZAČ ŽICE

10x

Br.	specifikacija	
50042		10



ZATEZAČ ŽIČANE OGRADE LT

Zn

Br.	specifikacija	
50037	Mali Zn presvučen	50
50038	Mali PVC presvučen	50

NOSAČ STUBA POCINČANI

Zn

Br.	specifikacija	tl.	
55436	70 x 75 mm	110 mm	4 mm 10
55437	80 x 90 mm	130 mm	4 mm 10



NOSAČ STUBA POCINČANI

Zn

Br.	specifikacija	tl.	
55429	70 x 60 mm	100 mm	4 mm 10
55433	81 x 60 mm	100 mm	4 mm 10
55430	91 x 60 mm	100 mm	4 mm 10
55431	101 x 60 mm	100 mm	4 mm 10
55432	121 x 60 mm	100 mm	4 mm 10

STUBNO
SIDRENO
STOPALO
PODESIVI

Zn

Br.	Specifikacija	tl.	
55465	80 - 160 x 70 mm	100 mm	4 mm 1

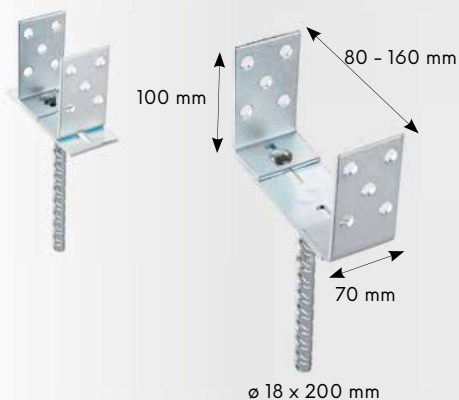

NOSAČ ZA STUBOVE ČETVRTASTI

Zn

Br.	Ø stopala	Dužina stopala	Debljina materijala	
55420	71 x 71 mm	150 mm	2 mm	1
55425	81 x 81 mm	150 mm	2 mm	1
55421	91 x 91 mm	150 mm	2 mm	1
55422	101 x 101 mm	150 mm	2 mm	1
55423	121 x 121 mm	150 mm	2 mm	1
55424	151 x 151 mm	150 mm	2 mm	1



SVRDLO ZA BUŠENJE ZEMLJE

Br.	Ø	A	B	
61299	110 mm	270 mm	1200 mm	1
61300	140 mm	270 mm	1200 mm	1
61301	170 mm	270 mm	1200 mm	1
61302	200 mm	270 mm	1200 mm	1

PODNOŽJE STUBA
SA VIJKOM ZA UGRADNJU

Zn

Br.	Ø stopala	visina stopala	konac	
55460	80 x 80 mm	150 mm	M16	10
55461	100 x 100 mm	150 mm	M16	10
55462	150 x 150 mm	150 mm	M24	10

DRŽAČ STUBA
USADNI

Zn

Br.	Ø stopala	Dužina stopala	Debljina materijala	
55400	71 x 71 mm	750 mm	2 mm	1
55401	91 x 91 mm	750 mm	2 mm	1
55406	81 x 81 mm	750 mm	2 mm	1
55402	91 x 91 mm	900 mm	2 mm	1
55403	101 x 101 mm	900 mm	2 mm	1
55404	121 x 121 mm	900 mm	2 mm	1
55405	151 x 151 mm	900 mm	2 mm	1

UNIVERZALNI
SET ZA
PRIČVRŠĆI-
VANJE "U,"

Zn

Br.	Ø stopala	Dužina stopala	Debljina materijala	
55455	71 x 60 mm	100 mm	4 mm	1
55452	81 x 60 mm	100 mm	4 mm	1
55456	90 x 60 mm	100 mm	4 mm	1
55453	101 x 60 mm	100 mm	4 mm	1
55457	110 x 60 mm	100 mm	4 mm	1
55454	121 x 60 mm	100 mm	4 mm	1

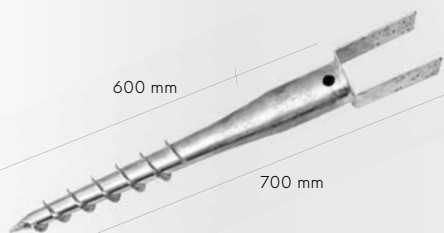
UNIVERZALNI SET
ZA PRIČVRŠĆIVANJE

• Reduction

Ø 24 mm
Ø 35 mm
Ø 40 mm
Ø 48 mm
Ø 55 mm

Zn 6x

Br.	Ø stopala	Dužina stopala	specifikacija	
55450	60 mm	550 mm	1 kom 5x smanjenje	8

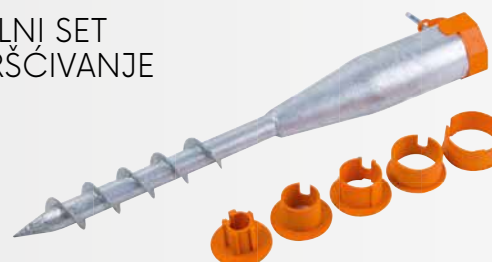

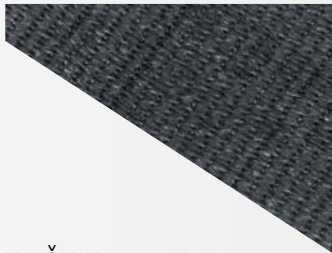

**MREŽA ZAŠTITNA HDPE
150 G/ M² ANTRACIT**

· Štiti do 85%



Br.	specifikacija	
45496	1 x 10 m	1
45497	1,5 x 10 m	1
45498	1,8 x 10 m	1
45499	2 x 10 m	1

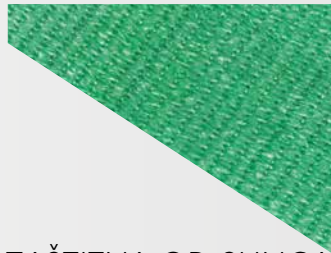

**MREŽA ZAŠTITNA OD SUNCA
HDPE 150 G/ M²**

· Štiti do 85%

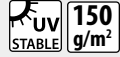

Br.	specifikacija	
45460	1 x 10 m	1
45461	1,5 x 10 m	1
45463	1,8 x 10 m	1
45462	2 x 10 m	1



**MREŽA ZAŠTITNA OD SUNCA
HDPE 220 G/ M²**

· Štiti do 95%



Br.	specifikacija	
45465	1 x 10 m	1
45466	1,5 x 10 m	1
45467	2 x 10 m	1



**MREŽA ZAŠTITNA OD
SUNCA HDPE 80 G/ M²**

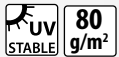

Br.	specifikacija	
45450	1 x 10 m	1
45451	1,5 x 10 m	1
45453	1,8 x 10 m	1
45452	2 x 10 m	1

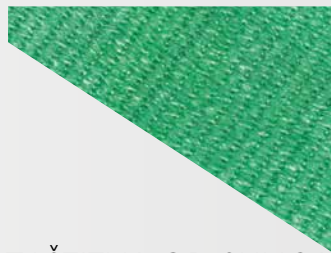

**MREŽA ZAŠTITNA OD SUNCA
HDPE 150 G/ M²**

· Štiti do 85%

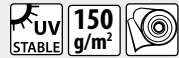

Br.	specifikacija	
45480	1,5 x 50 m	1

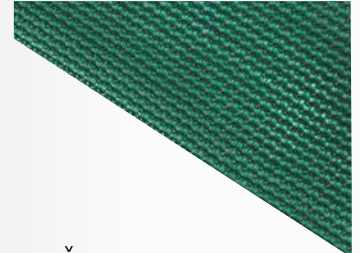

**MREŽA ZAŠTITNA OD
SUNCA HDPE 220 G/ M²**

· Štiti do 95%

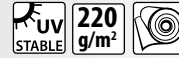

Br.	specifikacija	
45485	1,5 x 50 m	1



VEZICE

· EN 50146
· nylon



Br.	Specifikacija	
23875	120 mm 4,8 mm	1



**KARIKA NA TKANINI
ZA ZATAMNJENJE**



Br.	specifikacija	
45470		1





PRIBOR ZA ROŠTILJ SET

INOX **18x**



Br. specifikacija
43077

6



PRIBOR ZA ROŠTILJ SET

INOX **3x**



Br. specifikacija
43071 380 mm

16



PRIBOR ZA ROŠTILJ

INOX



Br. specifikacija
43072 360 mm

25



TACNA AL.ZA ROŠTILJ

4x

Br. specifikacija
43050 300 x 200 mm

50

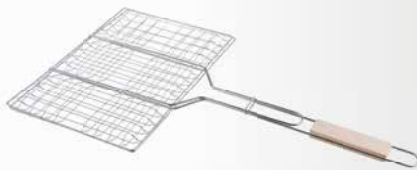

REŠETKA ZA GRIL

Br. specifikacija
43084 330 x 290 mm

50

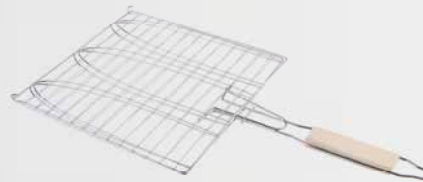

ROŠTILJ ZA RIBE

Br. specifikacija
43082 280 x 276 mm

50

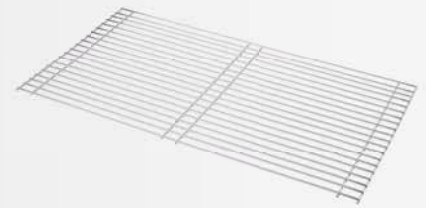

REŠETKA ZA ROŠTILJ

Br. specifikacija
43058 58 x 30 mm
43060 60 x 40 mm
43068 68 x 40 mm

20
20
16

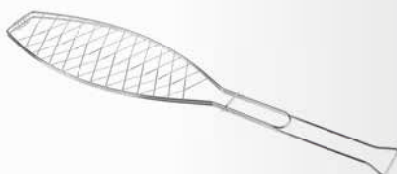

REŠETKA ZA PEČENJE RIBE

Br. specifikacija
43083 360 x 130 mm

12



ŠTAPICI METALNI ZA RAŽNJIČE

4x

Br. specifikacija
43086 Ø 3 x 380 mm

80



VILJUŠKA ZA ROŠTILJ

• S higijenskim atestom

Br. specifikacija
43097 100 cm

100



285 - 900 mm

VILJUŠKA ZA ROŠTILJ - TELESKOPSKA



Br. specifikacija
43094

1



MEH ZA ROŠTILJ



Br. specifikacija
43087

1



ČETKA ZA ROŠTILJ 2 V 1

Br. specifikacija
43098 30 cm

10



ČETKA ZA ROŠTILJ 3V1

Br. specifikacija
43099

40



MOTOR ZA RAŽANJ 230V



Br. specifikacija
43090

24



MOTOR ZA RAŽANJ

battery type D



Br. specifikacija
43089

48



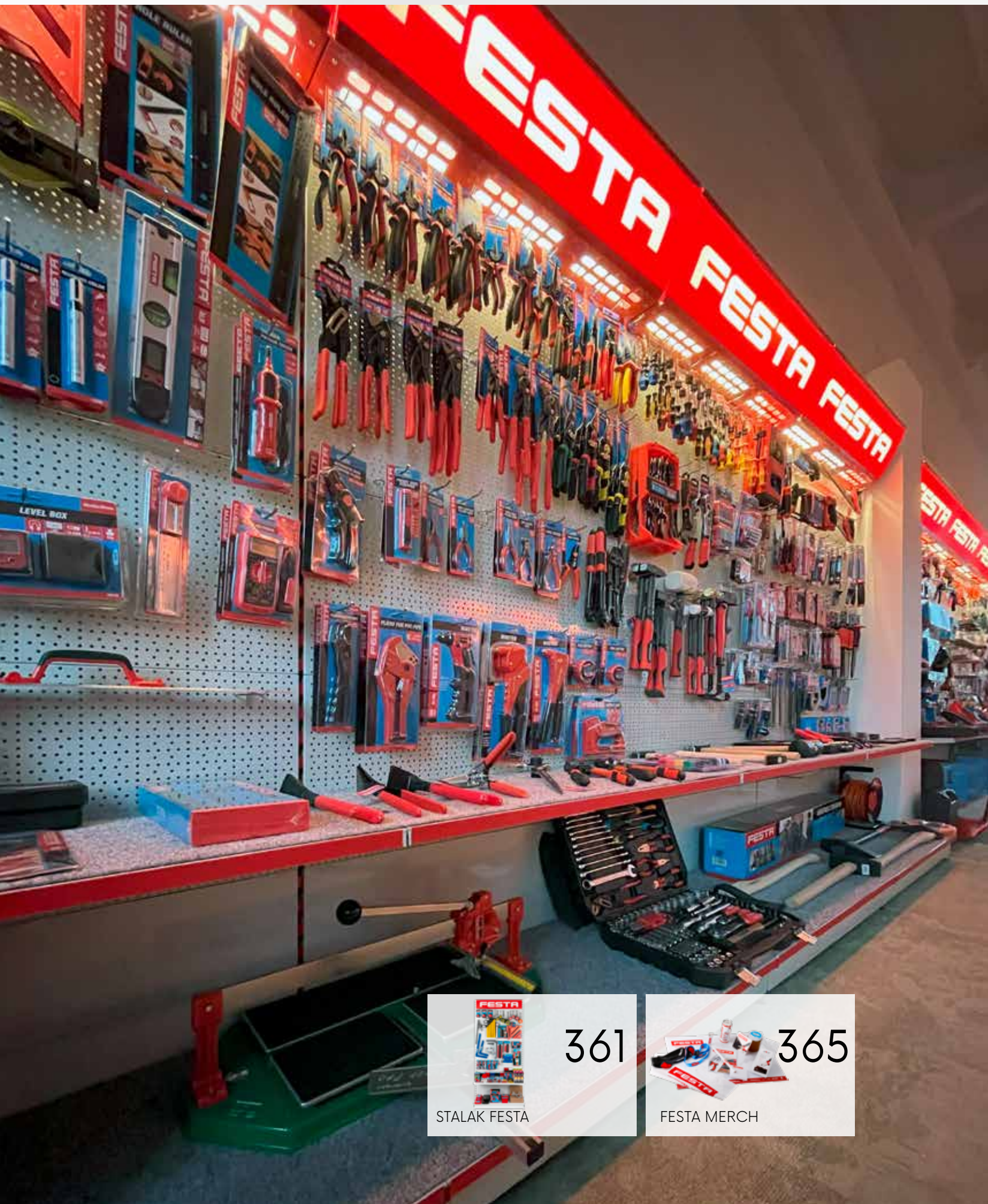

361

STALAK FESTA



365

FESTA MERCH



STALAŽ FESTA ISPUNJEN

FESTA

SVETLOSNA KUTIJA ZA FESTA STALAŽ 81011

Br.	Specifikacija	
81195	FESTA POWER TOOLS	1
81196	FESTA	1
81197	FESTA INDUSTRY	1



POLICA FESTA



Br.	Specifikacija	
81011	Stalaž FESTA CZ 200 x 100 cm	1
81011A	Stalaž 81011 + nalepnica AQUATIC	1
81011F	Stalaž 81011 + nalepnica FESTA CZ	1
81011G	Stalaž 81011 + nalepnica FESTA GB	1
81011H	Stalaž 81011 + nalepnica FESTA SK	1
81011R	Stalaž 81011 + nalepnica ROSA	1
81012	Polica CZ Dubina 40 cm	8
81013	Kukica 10 cm	10
81014	Kukica 16 cm	10
81015	Kukica 20 cm	10
81035	Kukica 20 cm	10
81016	Kukica 30 cm	10
81036	Kukica 30 cm	10
81022	wire basket - big, 50 cm	1
81023	wire basket - small, 40 cm	1
81024	partition - big, 50 cm	1
81025	partition - small, 40 cm	1

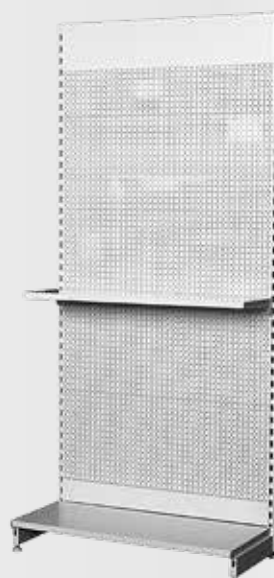

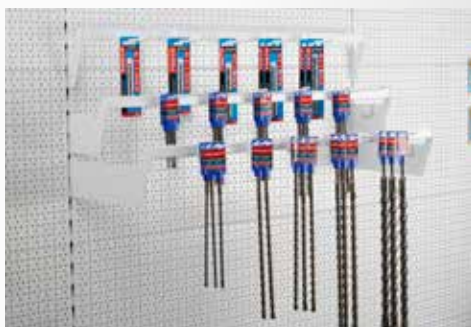

PRODAJNA KONZOLA

· Kompatibilno sa standom FESTA

Br.	Specifikacija	
81150	1000 x 50 x 135 mm	1
81151	1000 x 150 x 135 mm	1
81152	1000 x 350 x 135 mm	1

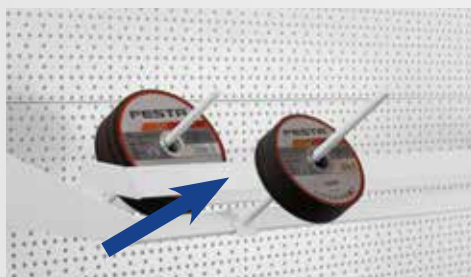

DRŽAČ ZA CENE

· Kompatibilno sa standom FESTA

Br.	Specifikacija	
81155	1000 x 80 x 100 mm	1



KUKE ZA REZNE PLOČE

· Kompatibilno sa standom FESTA

Br.	Specifikacija	
81186	150 mm	1
81185	250 mm	1



KONZOLA ZA REZNE PLOČE

· Kompatibilno sa standom FESTA

Br.	Specifikacija	
81170	1000 x 450 x 85 mm	1



DRŽAČ ZA TESTERE

· Kompatibilno sa standom FESTA

Br.	Specifikacija	
81190		1



KUKA ZA AKUMULATORSKI ALAT

· Kompatibilno sa standom FESTA

Br.	Specifikacija	
81189		1



POLICE ZA REZNE PLOČE

· Kompatibilno sa standom FESTA

Br.	Specifikacija	
81191	220 x 220 x 200 mm	1

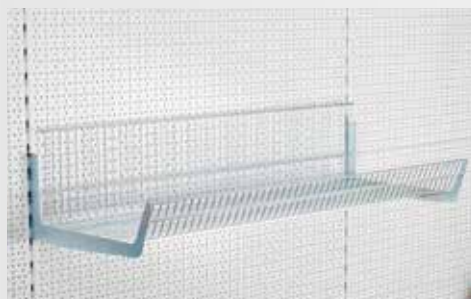

KOŠA ŽIČANA

· Kompatibilno sa standom FESTA

Br.	Specifikacija	
81160	1000 x 470 x 180 mm	1



PREGRADA

· Kompatibilno sa standom FESTA

Br.	Specifikacija	
81165	470 x 180 mm	1



DRŽAČ ČEKIĆA I MALJEVA

Zn

· Kompatibilno sa standom FESTA

Br.	Specifikacija	
81188	max 2 kg	1

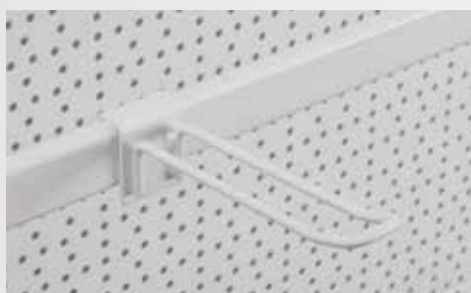

KUKA ZA HORIZONTALNU LAJSNU

· Kompatibilno sa standom FESTA

Br.	Specifikacija	
81175	120 mm	1
81178	180 mm	1



KUKA ZA HORIZONTALNU LAJSNU

· Kompatibilno sa standom FESTA

Br.	Specifikacija	
81180	120 mm	1



Br.	Specifikacija	
81200	Stožac 40/2400 mm učvršćen	1
81201	Stožac 80/1108 mm	1
81202	Stožac 80/1208 mm	1
81203	Stožac 80/1408 mm	1
81204	Stožac 80/1608 mm	1
81205	Stožac 80/1808 mm	1
81206	Stožac 80/2000 mm	1
81207	Stožac 80/2108 mm	1
81208	Stožac 80/2208 mm	1
81209	Stožac 80/2308 mm	1
81210	Stožac 80/2408 mm	1
81211	Stožac 80/2600 mm	1
81212	Stožac 60/1000 mm	1
81213	Stožac 60/1208 mm	1
81214	Stožac 60/1408 mm	1
81215	Stožac 60/1608 mm	1
81216	Stožac 60/1808 mm	1
81217	Stožac 60/2108 mm	1
81218	Stožac 60/2208 mm	1
81225	Stožac 30/2108 mm prednji	1
81489	Stožac 60/2000 mm	1
81219	Nastavak stošca 80x30/100mm	1
81220	Nastavak stošca 80x30/400 mm	1
81221	Nastavak stošca 80x30/600 mm	1
81222	Nastavak stošca 60x30/400 mm	1
81223	Ugaoni stožac 90° 2100mm	1
81224	Ugaoni stožac 90° 2200mm	1
81226	Oslonac 80	1
81227	Oslonac 60	1
81228	Veza korpe sa policom 80	1
81229	Letva za učvršćenje	1
81230	Kuka za učvršćenje	1
81231	Slabo učvršćenje	1
81232	Učvršćenje vrhom	1
81233	Punjenje 400	1
81234	Punjenje 500	1
81235	Punjenje 600	1
81236	Punje nje 700	1
81237	Punjenje 800	1
81238	Niska konzola 200	1
81239	Niska konzola 300	1
81240	Niska konzola 400	1
81241	Niska konzola 500	1
81242	Visoka konzola 400	1
81243	Visoka konzola 500	1
81244	Visoka konzola 600	1
81245	Visoka konzola 700	1
81246	Niska konzola 300 dupla	1
81247	Niska konzola 400 dupla	1
81248	Niska konzola 300 dupla	1
81251	Konzola RR 80	1
81249	Visoka konzola dupla 500 sanduka	1
81250	Nosač visokog sanduka 400/2000	1
81252	Pregrada police sa udubljenjem	1
81253	Niska pregrada 300	1
81254	Niska pregrada 400	1
81255	Niska pregrada 500	1
81256	Niska pregrada 300 staklo	1
81257	Niska pregrada 400 staklo	1
81258	Niska pregrada 500 staklo	1
81259	Visoka pregrada 300 staklo	1
81262	Visoka pregrada 300 pleKomi-staklo	1
81263	Visoka pregrada 400 pleKomi-staklo	1
81264	Visoka pregrada 500 pleKomi-staklo	1
81260	Visoka pregrada 400 staklo	1
81261	Visoka pregrada 500 staklo	1
81265	Bočna Str. visokog sanduka 400/2000	1
81266	Bočne strane poklopca RR 80	1
81267	Bočne strane spremnika 500mm	1
81268	Bočne strane sanduka 500	1
81269	Gornji nosač 500 sanduka	1
81271	Bočne strane niske police 300 plastika	1
81272	Bočne strane niske police 400 plastika	1
81273	Bočne strane niske police 500 plastika	1
81274	Bočne strane visoke staklo 300/250	1
81275	Osigurač bočnih strana	1
81276	Bočne strane visoke staklo 500/250	1
81277	Bočne strane visoke police 400	1
81278	Bočne strane visoke police 500	1
81270	Nosač poklopca RR 80	1
81279	Nosač poklopca	1
81280	Bočne strane poklopca leve	1
81281	Bočne strane poklopca desne	1
81282	Krak za vešanje	1
81284	Krak dupla 400/10	1
81285	Krak dupla 300/8	1
81286	Krak 350	1
81287	Krak 500	1
81288	Krak 250	1
81289	Vešanje dupla 100	1
81290	Vešanje dupla 200	1
81291	Vešanje dupla 300	1
81292	Vešanje 130 V	1

Br.	Specifikacija	
81293	Vešanje 100	1
81294	Vešanje 200	1
81295	Vešanje 300	1
81296	Kuka sa šipkom 200	1
81297	Kuka sa šipkom 300	1
81298	Brava za sanduka	1
81299	Pregrada žičane 360mm visoka	1
81300	Pregrada žičane 460 mm visoka	1
81301	Pregrada žičane 560 mm visoka	1
81302	Pregrada žičane 560 mm niska	1
81303	Konzola 300 dupla L	1
81304	Konzola 300 dupla P	1
81305	Konzola 400 dupla L	1
81306	Konzola 400 dupla P	1
81307	Konzola 500 dupla L	1
81308	Konzola 500 dupla P	1
81309	Polica polukrug 300	1
81310	Polica polukrug 400	1
81311	Polica polukrug 500	1
81312	Podnožje polukrug 500	1
81313	Čelni podnožje polukrug 500	1
81314	Držač trake za cene 300 polukrug	1
81315	Držač trake za cene 400 polukrug	1
81316	Držač trake za cene 500 polukrug	1
81317	Polica polukrug 600	1
81318	Podnožje polukrug 600	1
81319	Čelni podnožje polukrug 600	1
81320	Trake za cene P 7,5x5 cm	1
81321	Trake za cene P 2,6x3,2 cm	1
81322	Trake za cene P 5,0x4,0 cm	1
81323	Polica šupljikavi 500/1000	1
81324	Veznik stožer 80, modul 1	1
81325	Zadnji panel 10x100cm	1
81326	Zadnji panel 20x100cm	1
81327	Zadnji panel 40x100cm	1
81328	Zadnji panel šupljikavi 20x100 cm EUR	1
81329	Zadnji panel šupljikavi 40x100 cm EUR	1
81330	Veza korpe sa policom 8x100cm	1
81331	Veza korpe sa policom 6x100cm	1
81332	Šarka 100cm	1
81333	Polica staklo 985/300 sanduka	1
81334	Polica staklo 985/400 sanduka	1
81335	Polica drvena 47/98,5	1
81336	Polica žičana 1000/500	1
81337	Polica dubok 1000x500	1
81338	Polica 200/1000	1
81339	Polica 300/1000	1
81340	Polica 400/1000	1
81341	Polica 500/1000	1
81342	Polica 400/1000 RAL7015	1
81343	Polica 500/1000 RAL7015	1
81347	Kostur visoke saduke 1000/400	1
81348	Staklo kostura visoke saduke 1000/400	1
81349	Crč	1
81350	Štop metalne police 500/100	1
81352	Čelna podrška visoka 1000 mm, staklo	1
81353	Čelna podrška visoka, pleKomi-staklo	1
81354	Čelna podrška niska 1000 mm, plastika	1
81355	Traka za cene, 1000mm	1
81356	Greben za crč regala	1
81351	Greben za visoka pregrada, 1000	1
81357	Greben, 1000 mm	1
81403	Greben za visoka pregrada, 1250 mm	1
81420	Greben za visoka pregrada, 625 mm	1
81358	Dupla žlijeb vrata saduka	1
81359	Držač trake za cene, 1000mm	1
81360	Vratašca vis. saduka 1000/2000	1
81361	Čelo poklopca, 1000mm	1
81362	Odbor poklopca, 1000mm	1
81363	Vratašca za ladica	1
81364	Vratašca za saduka	1
81365	Ogledalo za saduka	1
81366	Kostura vješanje modul 1	1
81367	Vješanje motka	1
81370	Kosa žičana korpa	1
81371	Pult sa punom pločom 1000mm	1
81372	Podnožje pulta SU 5 1000mm	1
81373	Pult stakleni 1000mm	1
81374	Pult sa pločom od nerdajućeg č. 1000mm	1
81375	Pult sa punom pločom 600mm	1
81376	Polica za pult 600mm	1
81377	Pult stakleni 600mm	1
81378	Police za pult 1000mm	1
81379	Dugačka polica za pult	1
81380	Visoki segment pulta 90°	1
81381	Dvostruki žleb pulta 1000mm, par	1
81382	Pomična vratašca, pult 1000mm, par	1
81383	Ladica ispod ploče	1
81384	Žičana polica RDE 1000/360mm	1
81385	Žičana polica RDE 1000/460mm	1
81386	Žičana polica RDE 1000/560mm	1
81387	Traka za cene RDE 1000 mm	1
81388	Zadnji panel 100/1250mm puni	1

Br.	Specifikacija	
81389	Zadnji panel 200/1250mm puni	1
81390	Zadnji panel 400/1250mm puni	1
81391	Zadnji panel 200/1250mm šupljikavi	1
81393	Pokrivač korpe 80/1250mm	1
81392	Zadnji panel 400/1250mm šupljikavi	1
81394	Pokrivač korpe 60/1250mm	1
81395	Šarka 1250mm	1
81396	Polica 200/1250mm	1
81439	Šarka 1000 mm	1
81344	Polica 300/1000 pojačana	1
81345	Polica 400/1000 pojačana	1
81346	Polica 500/1000 pojačana	1
81397	Polica 300/1250mm	1
81400	Polica 300/1250mm, pojačana	1
81401	Polica 400/1250mm, pojačana	1
81402	Polica 500/1250mm, pojačana	1
81398	Polica 400/1250mm	1
81399	Polica 500/1250mm	1
81404	Niski čeon naslon 1250mm, bela plastika	1
81405	Traka za cene, 1250mm	1
81406	Greben 1250mm	1
81407	Držač trake za cene, 1250mm	1
81408	Čelo poklopca, 1250mm	1
81409	Ploča poklopca, 600x1250mm	1
81410	Zadnji panel 100/625 puni	1
81411	Zadnji panel 200/625 puni	1
81412	Zadnji panel 400/625 puni	1
81413	Zadnji panel 400/625 šupljikavi	1
81414	Veza korpe sa policom 80/650	1
81415	Veza korpe sa policom 60/650	1
81416	Šarka, modul 3	1
81432	Šarka, 1330mm	1
81417	Polica 300/625	1
81418	Polica 400/625	1
81419	Polica 500/625	1
81421	Niski čeon naslon 625, bela plastika	1
81422	Traka za cene 625mm	1
81423	Greben 625mm	1
81424	Držač trake za cene, 625mm	1
81425	Zadnji panel 100/1330 puni	1
81457	Niski čeon naslon 200 plastika	1
81426	Zadnji panel 200/1330 puni	1
81427	Zadnji panel 400/1330 puni	1
81428	Zadnji panel 200/1330 šupljikavi S	1
81429	Zadnji panel 400/1330 šupljikavi S	1
81430	Pokrivač korpe 80/1330	1
81431	Pokrivač korpe 60/1330	1
81433	Polica 300/1330	1
81434	Polica 400/1330	1
81435	Polica 500/1330	1
81436	Traka za cene, 1330 mm	1
81437	Greben 1330 mm	1
81438	Držač trake za cene 1330 mm	1
81440	Polica žičana- korpa	1
81441	Zadnji panel 100 ugaoni	1
81442	Zadnji panel 400 ugaoni	1
81443	Čelo podnožja ugaono 500/1000 mm	1
81444	Čelo podnožja ugaono 600 mm	1
81445	Zadnji panel ugaono 400mm šupljikavi	1
81447	Polica 300 ugaono	1
81448	Polica 400 ugaono	1
81449	Polica 500 ugaono	1
81450	Polica 600 ugaono	1
81451	Držač trake za cene 300 ugaoni	1
81452	Držač trake za cene 400 ugaoni	1
81453	Držač trake za cene 500 ugaoni	1
81454	Traka za cene 300 ugaona	1
81455	Traka za cene 400 ugaona	1
81456	Traka za cene 500 ugaona	1
81458	Žičana polica- korpa U 1000/400	1
81459	Žičana polica- korpa U 1000/500	1
81460	Ugaono čelo podnožja 90°	1
81461	Zadnji panel ugaoni 100, stožac 60	1
81462	Zadnji panel ugaoni 200, stožac 60	1
81463	Zadnji panel ugaoni 400, stožac 80	1
81466	Zadnji panel ugaoni 100, stožac 80	1
81467	Zadnji panel ugaoni 400, stožac 60	1
81468	Polica ugaoni 90° 400mm	1
81469	Polica ugaoni 90° 500mm	1
81470	Ugaoni držač trake za cene 90° 400mm	1
81471	Ugaoni držač trake za cene 90° 500mm	1
81472	Traka za cene 90° 400mm ugaona	1
81473	Traka za cene 90° 500mm ugaona	1



KONZOLA BELA

MOQ
2

Br.	Specifikacija	
81100	100 x 75 mm	24
81101	125 x 100 mm	24
81102	150 x 125 mm	24
81103	200 x 150 mm	24
81104	250 x 200 mm	24
81105	300 x 250 mm	24
81106	350 x 300 mm	24



DRŽAČ (NOGA) REGALA

Br.	Specifikacija	
81053	50 cm	10
81054	80 cm	10
81057	200 cm	10



KONZOLA

Br.	Specifikacija	
81070	10 cm	10
81071	15 cm	10
81077	50 cm	10

STALAK ZA PAPIR PRO LEVELING SYSTEMS



Br.	Specifikacija	
37179	60 x 40 x 175 cm - ENG	1



STALAK ZA PAPIR FESTA



Br.	Specifikacija	
81602	60 x 40 x 175 cm - ENG	1

STALAK ZA PAPIR FESTA POWER TOOLS



Br.	Specifikacija	
81603	60 x 40 x 175 cm	1



FESTA

REKLAMNI BLOK FESTA

Br. Specifikacija
M90400



FESTA

REKLAMNA MAJICA CRVENA FESTA

Br.	Specifikacija	
M90203	M	1
M90204	L	1
M90205	XL	1
M90206	XXL	1
M90207	XXXL	1



FESTA

REKLAMNA OLOVKA FESTA

Br. Specifikacija
M90403



FESTA

REKLAMNI USB KABL FESTA

Br. Specifikacija
M90519



FESTA

REKLAMNE ČARAPE FESTA

Br.	Specifikacija	
M90220	39-41	1
M90221	42-44	1
M90222	45-47	1



FESTA

REKLAMNI METAR FESTA

Br. Specifikacija
11410 2 m x 16 mm



FESTA

REKLAMNA KAP FESTA

Br.	Specifikacija	
M90210		1



FESTA

REKLAMNI SKLOPIVI NOŽ FESTA

Br. Specifikacija
16209



broj artikla	strana	broj artikla	strana	broj artikla	strana	broj artikla	strana	broj artikla	strana	broj artikla	strana
10002	96	11355	98	13249	121	13414	101	13509	99	14420	104
10003	96	11356	98	13250	121	13415	101	13510	99	14421	104
10005	96	11358	98	13251	121	13416	101	13511	99	14425	105
10008	96	11360	98	13252	121	13417	101	13512	99	14430	105
10025	96	11410	100	13253	121	13418	101	13513	99	14435	105
10033	96	11410	365	13254	121	13419	101	13514	99	14440	105
10035	96	11416	99	13255	121	13420	101	13515	99	14445	105
10043	96	11420	100	13256	121	13421	101	13516	99	14446	105
10045	96	11425	100	13257	121	13422	101	13517	99	14450	105
10048	96	11444	100	13258	121	13423	101	13518	99	14451	105
10110	96	11445	100	13259	121	13424	101	13519	99	14455	105
10120	96	12010	99	13260	120	13425	101	13520	99	14456	105
10130	96	12020	99	13261	117	13426	101	13521	99	14457	105
10330	96	12030	99	13262	117	13427	101	13522	99	14458	105
10332	96	12050	99	13263	117	13428	101	13523	99	14471	105
10334	96	12110	99	13264	116	13429	101	13524	99	14472	105
10336	96	12120	99	13265	116	13430	101	13525	99	14473	105
10430	97	12130	99	13266	116	13431	101	13526	99	14474	105
10450	97	12150	99	13267	117	13432	101	13527	99	14480	104
10490	97	12220	99	13268	116	13433	101	13528	99	14485	109
10996	97	12230	99	13269	116	13434	101	13529	99	14485	271
10998	97	12250	99	13270	116	13435	101	13530	99	14486	109
10999	97	12433	100	13271	116	13436	101	13531	99	14486	271
11002	99	12435	100	13272	116	13437	101	13532	99	14490	105
11003	99	13010	101	13273	116	13438	101	13533	99	14491	105
11005	99	13020	101	13274	116	13439	101	13534	99	14492	105
11006	99	13021	101	13275	116	13440	101	14001	102	14493	105
11007	99	13022	101	13276	117	13441	101	14002	102	14494	105
11008	99	13023	101	13277	120	13442	101	14003	102	15003	107
11082	99	13111	101	13278	116	13443	101	14004	102	15004	107
11083	99	13120	101	13279	117	13444	101	14006	102	15005	107
11085	99	13200	118	13280	117	13445	101	14007	102	15006	107
11102	98	13201	118	13281	102	13446	101	14008	102	15008	107
11103	98	13202	118	13282	102	13447	101	14009	102	15010	107
11105	98	13205	119	13284	117	13448	101	14010	103	15012	107
11106	98	13206	119	13285	102	13449	101	14011	103	15015	107
11107	98	13207	119	13288	117	13450	101	14012	103	15018	107
11110	98	13208	119	13290	217	13451	101	14013	102	15020	107
11200	99	13211	101	13293	217	13452	101	14015	103	15033	106
11201	99	13212	119	13294	217	13453	101	14017	103	15034	106
11202	99	13214	118	13295	120	13454	101	14019	103	15035	106
11204	99	13216	118	13296	120	13455	101	14025	105	15036	106
11205	99	13217	118	13350	121	13456	101	14030	103	15037	106
11206	99	13218	118	13351	121	13457	101	14035	102	15039	106
11207	99	13219	118	13352	121	13458	101	14040	102	15103	107
11208	99	13220	101	13353	121	13459	101	14045	102	15104	107
11209	99	13222	118	13354	121	13460	101	14060	103	15105	107
11210	99	13223	118	13355	121	13461	101	14070	103	15106	107
11220	98	13224	118	13360	121	13462	101	14075	103	15108	107
11221	98	13225	118	13361	121	13463	101	14077	103	15110	107
11226	98	13226	118	13362	121	13464	101	14080	102	15112	107
11239	98	13227	118	13363	121	13465	101	14090	104	15115	107
11259	98	13228	118	13364	121	13466	101	14091	104	15118	107
11260	98	13229	118	13365	121	13467	101	14220	105	15120	107
11311	100	13230	118	13399	101	13468	101	14225	105	15204	107
11312	100	13231	118	13400	101	13469	101	14230	105	15205	107
11313	100	13235	118	13401	101	13470	101	14235	105	15206	107
11314	100	13236	118	13402	101	13471	101	14240	105	15208	107
11323	98	13237	118	13403	101	13472	101	14250	105	15210	107
11325	98	13238	118	13404	101	13473	101	14350	105	15212	107
11327	98	13240	120	13405	101	13500	99	14360	105	15215	107
11333	98	13241	120	13406	101	13501	99	14370	105	15218	107
11335	98	13242	120	13407	101	13502	99	14380	105	15220	107
11337	98	13243	120	13408	101	13503	99	14399	105	15230	107
11338	98	13244	120	13409	101	13504	99	14410	105	15235	108
11343	98	13245	120	13410	101	13505	99	14411	105	15301	109
11345	98	13246	119	13411	101	13506	99	14415	104	15301	271
11347	98	13247	119	13412	101	13507	99	14417	104	15310	108
11353	98	13248	119	13413	101	13508	99	14418	104	15310	270

broj artikla	strana	broj artikla	strana	broj artikla	strana	broj artikla	strana	broj artikla	strana	broj artikla	strana
15315	108	15810	109	16003	122	16075	130	16300	139	17037	137
15315	270	15810	271	16004	122	16077	130	16301	139	17038	177
15318	108	15812	109	16005	122	16078	130	16303	139	17039	176
15318	270	15812	271	16006	122	16081	130	16304	139	17040	174
15320	108	15815	109	16010	122	16082	129	16305	138	17041	174
15320	270	15815	271	16010	122	16083	131	16306	138	17042	174
15325	108	15818	109	16011	122	16084	131	16307	138	17043	174
15325	270	15818	271	16011	122	16085	126	16308	138	17044	174
15330	108	15820	109	16011	122	16086	126	16309	138	17045	174
15330	270	15820	271	16012	122	16087	127	16310	139	17046	177
15335	108	15825	109	16012	122	16090	125	16310	139	17047	172
15335	270	15825	271	16012	122	16091	125	16311	139	17048	177
15340	108	15830	109	16013	122	16095	127	16311	139	17049	177
15340	270	15830	271	16013	122	16099	124	16311	139	17050	139
15415	108	15850	109	16016	122	16100	124	16312	139	17050	181
15415	270	15850	271	16017	122	16105	124	16312	139	17051	177
15418	108	15853	109	16019	122	16110	124	16315	137	17052	177
15418	270	15853	271	16021	128	16115	124	16315	137	17053	177
15420	108	15855	109	16023	127	16120	124	16319	139	17054	177
15420	270	15855	271	16024	128	16125	124	16320	139	17055	177
15425	108	15860	109	16025	125	16130	126	16321	139	17056	177
15425	270	15860	271	16026	128	16131	124	16321	229	17057	177
15430	108	15870	109	16028	128	16135	126	16401	181	17058	177
15430	270	15870	271	16029	125	16136	125	16405	181	17059	176
15510	108	15880	109	16030	128	16137	125	16406	181	17060	176
15510	270	15880	271	16031	128	16140	126	16407	181	17061	176
15515	108	15885	256	16032	128	16141	128	16408	181	17062	176
15515	270	15886	256	16033	127	16142	125	16420	181	17063	175
15518	108	15886	349	16034	126	16143	125	16500	176	17064	175
15518	270	15887	256	16035	127	16144	125	16501	176	17065	175
15520	108	15887	349	16036	129	16145	125	16502	176	17066	175
15520	270	15888	256	16037	127	16146	125	16990	136	17067	175
15525	108	15888	349	16039	127	16147	126	16990	320	17068	175
15525	270	15889	256	16041	129	16150	125	16991	136	17069	175
15530	108	15893	109	16042	129	16151	125	16991	320	17070	175
15530	270	15893	271	16042	279	16198	131	16998	122	17071	175
15535	108	15894	109	16043	128	16199	131	16999	122	17072	175
15535	270	15894	271	16044	126	16201	132	17001	171	17075	175
15540	108	15895	109	16046	128	16202	173	17002	171	17076	175
15540	270	15895	271	16049	129	16205	173	17003	171	17077	175
15615	108	15904	111	16050	129	16206	173	17004	171	17078	177
15615	270	15906	111	16051	129	16208	173	17005	171	17079	176
15620	108	15908	111	16052	129	16209	133	17006	171	17080	176
15620	270	15910	111	16053	128	16209	365	17007	171	17081	176
15625	108	15912	111	16054	129	16210	132	17008	171	17082	176
15625	270	15915	111	16055	128	16211	132	17009	171	17083	178
15630	108	15920	111	16056	278	16212	132	17010	171	17084	176
15630	270	15954	111	16057	126	16218	133	17011	171	17085	176
15710	109	15956	111	16058	126	16219	133	17012	176	17086	176
15710	270	15958	111	16059	129	16220	133	17013	176	17087	172
15715	109	15960	111	16060	130	16221	133	17014	176	17089	178
15715	270	15962	111	16061	130	16222	133	17015	178	17090	178
15720	109	15965	111	16062	130	16223	133	17016	178	17091	178
15720	270	15970	111	16063	130	16224	134	17017	178	17092	178
15725	109	15980	111	16064	130	16225	132	17019	178	17093	178
15725	270	15981	111	16065	130	16226	134	17020	177	17094	171
15730	109	15983	100	16066	124	16227	134	17021	177	17095	171
15730	270	15985	100	16066	130	16228	134	17022	177	17096	171
15735	109	15988	100	16067	130	16229	132	17023	175	17097	171
15735	270	15989	100	16068	130	16230	132	17024	171	17098	171
15740	109	15990	111	16069	129	16231	132	17025	174	17099	171
15740	270	15991	111	16070	129	16231	135	17026	137	17100	171
15754	110	15992	111	16070	131	16232	134	17027	137	17101	169
15756	110	15993	111	16071	127	16232	174	17028	177	17102	169
15758	110	15996	110	16071	130	16234	132	17029	176	17103	169
15760	110	15997	110	16072	130	16235	133	17033	176	17104	169
15762	110	15998	110	16073	131	16236	133	17034	175	17105	169
15768	110	15999	110	16074	126	16281	127	17035	175	17108	171
15770	110	16002	122	16074	131	16282	127	17036	175	17109	175

broj artikla	strana	broj artikla	strana	broj artikla	strana	broj artikla	strana	broj artikla	strana	broj artikla	strana
17110	171	17238	156	17393	160	17528	165	17622	164	17831	159
17111	179	17240	158	17394	160	17532	166	17623	164	17832	159
17112	179	17241	158	17395	160	17533	166	17624	164	17835	159
17113	179	17242	158	17396	160	17534	166	17625	164	17836	159
17116	179	17243	158	17397	160	17539	165	17626	164	17837	159
17117	179	17244	158	17398	160	17548	164	17628	164	17838	159
17121	179	17245	155	17400	161	17549	164	17629	164	17839	159
17122	179	17247	153	17401	160	17550	164	17630	164	17840	159
17125	172	17250	161	17402	160	17551	164	17631	164	17841	159
17126	172	17255	161	17405	160	17552	164	17632	164	17842	159
17127	172	17259	153	17406	160	17553	164	17633	164	17843	159
17128	172	17260	153	17407	160	17554	164	17640	166	17844	159
17130	172	17261	167	17410	160	17555	164	17642	166	17845	159
17133	172	17262	167	17411	160	17556	164	17643	166	17846	159
17135	172	17292	158	17412	160	17557	164	17644	166	17847	159
17137	172	17294	158	17413	160	17558	164	17645	166	17848	159
17138	172	17295	158	17414	160	17559	164	17650	166	17849	159
17140	169	17296	158	17415	160	17560	164	17651	166	17850	159
17142	169	17297	158	17416	160	17561	164	17652	166	17851	159
17145	169	17298	158	17420	160	17562	164	17653	166	17852	159
17146	169	17299	158	17421	160	17563	164	17654	166	17853	159
17148	169	17300	178	17422	160	17564	164	17655	166	17854	159
17150	175	17301	178	17427	161	17565	164	17656	166	17855	159
17151	175	17302	178	17450	167	17566	164	17657	166	17856	159
17158	181	17303	178	17451	167	17567	164	17658	166	17860	159
17159	181	17304	178	17452	167	17568	164	17659	166	17861	159
17160	181	17305	178	17454	168	17569	164	17660	164	17862	159
17165	179	17306	178	17455	161	17570	164	17661	164	17863	159
17167	179	17308	159	17455	168	17571	164	17662	164	17864	159
17169	179	17309	159	17456	168	17572	164	17663	164	17865	159
17170	179	17310	159	17458	168	17573	164	17664	164	17866	159
17172	178	17311	159	17459	168	17574	164	17665	164	17867	159
17175	180	17312	159	17460	164	17575	164	17666	164	17868	159
17177	180	17313	159	17461	164	17576	164	17667	164	17869	159
17178	172	17314	159	17462	164	17577	164	17668	164	17870	159
17180	172	17315	159	17463	164	17578	164	17669	164	17871	159
17181	172	17316	159	17464	164	17579	164	17670	164	17872	159
17182	45	17317	159	17465	164	17580	164	17671	164	17873	159
17182	137	17318	159	17467	164	17581	164	17672	164	17874	159
17183	45	17319	159	17468	164	17582	164	17674	164	17875	159
17183	137	17320	159	17469	164	17583	164	17675	164	17876	159
17185	181	17321	159	17470	164	17584	164	17676	164	17877	159
17186	180	17322	159	17471	164	17585	164	17677	164	17878	159
17187	181	17324	159	17472	164	17586	164	17678	164	17879	159
17188	181	17327	159	17473	164	17587	164	17679	164	17880	159
17189	181	17330	159	17475	166	17589	164	17680	168	17881	159
17190	174	17332	159	17476	166	17590	164	17681	168	17882	159
17191	174	17333	159	17480	164	17591	164	17682	168	17883	159
17192	174	17334	159	17481	164	17592	164	17683	164	17884	159
17193	174	17338	167	17482	164	17593	164	17685	165	17885	159
17197	165	17341	178	17483	164	17600	167	17761	164	17886	159
17198	165	17342	178	17484	164	17601	167	17769	164	17887	159
17199	165	17350	162	17485	164	17603	167	17788	164	17888	159
17200	165	17351	162	17486	164	17605	164	17795	164	17889	159
17201	165	17352	162	17487	164	17606	164	17806	164	17890	159
17202	165	17353	162	17488	164	17607	164	17810	161	17891	159
17203	167	17357	162	17489	164	17608	164	17811	161	17892	159
17204	167	17359	162	17490	164	17609	164	17812	161	17895	159
17205	167	17361	162	17491	164	17610	164	17820	159	17896	159
17206	167	17380	161	17492	164	17611	164	17821	159	17897	159
17229	155	17381	161	17493	164	17612	164	17822	159	17898	159
17230	155	17382	160	17494	164	17613	164	17823	159	17904	159
17231	155	17383	160	17495	164	17614	164	17824	159	17905	159
17233	155	17384	160	17496	164	17615	164	17825	159	17907	159
17234	155	17385	160	17501	166	17616	164	17826	159	17910	159
17235	156	17386	160	17506	165	17617	164	17827	159	17914	159
17236	156	17390	160	17508	165	17619	165	17828	159	17916	159
17237	154	17391	160	17512	166	17620	166	17829	159	17922	159
17238	153	17392	160	17526	165	17621	166	17830	159	17924	159

broj artikla	strana	broj artikla	strana	broj artikla	strana	broj artikla	strana	broj artikla	strana	broj artikla	strana
17926	159	18302	143	18498	163	18638	147	18828	148	18971	160
17930	159	18303	143	18499	163	18639	147	18829	148	18993	150
17934	159	18304	143	18500	163	18640	147	18830	148	18994	150
17935	159	18310	140	18501	162	18641	147	18831	148	19001	197
17943	159	18311	140	18508	163	18645	147	18832	148	19002	197
17944	159	18312	140	18510	162	18646	147	18835	148	19003	197
17970	148	18313	140	18511	162	18680	147	18836	148	19004	197
17971	148	18321	140	18512	162	18685	147	18837	148	19005	197
17972	148	18322	140	18513	162	18710	146	18838	148	19006	197
17973	148	18340	141	18514	162	18711	146	18839	148	19008	197
17974	148	18350	140	18515	162	18712	146	18840	148	19010	197
17975	148	18351	140	18516	162	18715	146	18841	148	19015	197
17976	148	18352	140	18518	162	18716	146	18842	148	19020	197
17980	148	18353	140	18519	162	18717	146	18843	148	19021	195
17981	148	18354	140	18520	162	18720	146	18844	148	19022	195
17982	148	18355	140	18521	162	18721	146	18845	148	19023	195
17983	148	18356	140	18522	162	18722	146	18846	148	19024	195
18062	142	18357	140	18523	162	18723	146	18847	148	19025	195
18063	142	18358	140	18524	162	18724	146	18850	148	19026	195
18064	142	18359	140	18527	162	18725	146	18851	148	19028	195
18065	142	18360	140	18567	162	18750	147	18852	148	19030	195
18066	142	18400	143	18572	162	18751	147	18853	148	19031	195
18067	142	18401	143	18575	162	18753	147	18855	148	19032	195
18070	142	18402	141	18576	162	18755	147	18856	148	19034	195
18071	142	18403	141	18577	162	18760	147	18860	148	19036	195
18072	142	18404	141	18578	162	18761	147	18861	148	19041	195
18075	142	18408	145	18579	162	18762	147	18862	148	19042	195
18076	142	18409	145	18580	162	18763	147	18863	148	19043	195
18077	142	18410	142	18581	162	18764	147	18864	148	19044	195
18080	142	18411	142	18582	162	18765	147	18865	148	19045	195
18081	142	18413	142	18583	162	18766	147	18866	148	19046	195
18082	142	18415	144	18584	162	18767	147	18867	148	19050	197
18083	142	18416	144	18585	162	18768	147	18868	148	19051	197
18084	142	18417	144	18587	162	18769	147	18869	148	19052	197
18085	142	18418	143	18588	162	18770	147	18870	148	19053	197
18086	142	18419	144	18589	162	18771	147	18871	148	19054	197
18087	142	18420	144	18593	162	18772	147	18872	148	19055	197
18088	142	18421	152	18600	149	18775	147	18873	148	19056	197
18089	142	18422	141	18601	149	18776	147	18874	148	19057	197
18090	142	18423	142	18602	149	18777	147	18900	151	19058	195
18091	142	18424	141	18603	158	18795	149	18901	151	19059	195
18092	142	18425	140	18604	161	18796	149	18905	151	19060	196
18101	143	18426	145	18605	149	18797	149	18906	151	19061	196
18102	143	18427	145	18607	149	18798	149	18907	152	19062	196
18103	143	18428	115	18608	144	18799	149	18908	151	19063	196
18104	143	18429	115	18609	150	18800	148	18909	151	19064	196
18105	143	18430	152	18610	150	18801	148	18910	145	19065	196
18106	143	18431	144	18611	150	18802	148	18915	152	19066	195
18107	143	18432	146	18612	150	18803	148	18920	160	19067	195
18108	143	18433	144	18613	150	18804	148	18921	160	19068	195
18110	143	18434	140	18614	150	18805	148	18922	160	19069	195
18113	140	18435	145	18615	150	18806	148	18925	160	19070	195
18114	140	18437	145	18618	150	18807	148	18926	160	19071	195
18115	140	18440	152	18619	149	18810	148	18927	160	19074	195
18116	140	18445	173	18619	161	18811	148	18928	160	19075	195
18118	140	18450	143	18620	147	18812	148	18929	160	19076	195
18120	140	18451	143	18621	147	18813	148	18930	160	19077	195
18124	140	18455	143	18623	147	18814	148	18931	160	19081	195
18125	140	18456	143	18625	147	18815	148	18934	160	19082	195
18201	143	18460	143	18627	147	18816	148	18939	160	19083	195
18202	143	18476	162	18628	147	18817	148	18948	160	19084	195
18203	143	18490	163	18630	147	18820	148	18950	160	19085	195
18204	143	18491	163	18631	147	18821	148	18951	160	19086	195
18210	140	18492	163	18632	147	18822	148	18954	160	19088	195
18211	140	18493	163	18633	147	18823	148	18955	160	19090	195
18212	140	18494	162	18634	147	18824	148	18956	160	19092	195
18215	140	18495	162	18635	147	18825	148	18960	160	19095	195
18216	140	18496	163	18636	147	18826	148	18961	160	19096	195
18301	143	18497	163	18637	147	18827	148	18963	160	19097	195

broj artikla	strana	broj artikla	strana	broj artikla	strana	broj artikla	strana	broj artikla	strana	broj artikla	strana
19098	195	19394	317	19473	202	19580	56	19643	56	19704	57
19100	196	19395	317	19474	202	19585	56	19644	56	19705	57
19106	195	19396	317	19477	202	19585	56	19645	56	19705	57
19108	195	19397	317	19478	202	19586	56	19645	56	19706	57
19109	195	19398	197	19480	202	19587	56	19646	56	19707	57
19110	200	19399	197	19481	202	19588	56	19647	56	19708	57
19115	44	19400	201	19483	202	19589	56	19648	56	19708	57
19115	197	19400	251	19485	201	19590	56	19649	56	19709	57
19124	196	19401	201	19486	201	19590	56	19650	56	19710	57
19136	196	19401	251	19487	201	19591	56	19650	56	19711	57
19148	196	19402	201	19490	135	19593	56	19651	56	19711	57
19149	196	19402	251	19491	135	19594	56	19652	56	19712	57
19150	196	19403	201	19492	135	19595	56	19653	56	19713	57
19151	196	19403	251	19493	135	19595	56	19654	56	19713	57
19202	198	19404	201	19494	135	19596	56	19655	56	19714	57
19208	199	19404	251	19495	135	19597	56	19656	56	19715	57
19209	199	19405	201	19496	135	19598	56	19657	56	19716	57
19211	199	19405	251	19497	135	19599	56	19658	56	19717	57
19245	198	19406	201	19498	135	19600	56	19659	56	19718	57
19246	198	19406	251	19499	135	19600	56	19660	56	19718	57
19247	198	19407	201	19501	135	19601	56	19661	56	19719	57
19248	198	19407	251	19502	135	19603	56	19662	56	19720	57
19249	198	19408	201	19510	134	19604	56	19663	56	19721	57
19251	199	19408	251	19515	134	19605	56	19664	56	19722	57
19252	199	19409	201	19520	134	19605	56	19665	56	19723	57
19253	199	19409	251	19530	56	19606	56	19669	56	19723	57
19254	199	19410	201	19530	56	19607	56	19670	57	19724	57
19255	199	19411	201	19535	56	19608	56	19671	57	19725	57
19265	199	19412	201	19535	56	19609	56	19672	57	19726	57
19270	199	19415	200	19536	56	19610	56	19673	57	19727	57
19271	199	19416	200	19537	56	19610	56	19673	57	19728	57
19272	199	19418	201	19538	56	19611	56	19674	57	19728	57
19281	199	19419	201	19539	56	19612	56	19675	57	19729	57
19290	199	19420	200	19540	56	19613	56	19676	57	19730	57
19293	199	19421	200	19540	56	19614	56	19677	57	19731	57
19294	199	19422	200	19543	56	19615	56	19678	57	19732	57
19295	199	19423	200	19544	56	19615	56	19678	57	19733	57
19297	199	19424	200	19545	56	19616	56	19679	57	19733	57
19301	316	19425	200	19545	56	19617	56	19680	57	19734	57
19303	196	19426	200	19550	56	19618	56	19681	57	19735	57
19306	317	19427	200	19550	56	19619	56	19682	57	19736	57
19308	317	19429	201	19552	56	19620	56	19683	57	19737	57
19310	317	19430	197	19552	56	19620	56	19683	57	19738	57
19312	317	19431	197	19554	56	19621	56	19684	57	19738	57
19314	317	19432	197	19555	56	19622	56	19685	57	19739	57
19326	316	19433	197	19555	56	19623	56	19686	57	19740	57
19328	316	19434	197	19557	56	19624	56	19687	57	19741	57
19330	316	19435	197	19558	56	19625	56	19688	57	19742	57
19332	316	19436	201	19559	56	19625	56	19688	57	19743	57
19333	316	19440	197	19560	56	19626	56	19689	57	19743	57
19335	316	19441	197	19560	56	19627	56	19690	57	19744	57
19337	316	19442	197	19562	56	19628	56	19691	57	19745	57
19340	316	19443	197	19562	56	19629	56	19692	57	19746	57
19370	317	19450	135	19564	56	19630	56	19693	57	19747	57
19371	317	19451	135	19565	56	19630	56	19693	57	19748	57
19374	317	19455	135	19565	56	19631	56	19694	57	19748	57
19380	316	19457	135	19567	56	19632	56	19695	57	19749	57
19381	316	19458	135	19568	56	19633	56	19695	57	19750	57
19382	316	19459	135	19568	56	19634	56	19696	57	19751	57
19383	316	19460	201	19570	56	19635	56	19697	57	19752	57
19384	316	19460	251	19570	56	19635	56	19698	57	19753	57
19385	316	19462	317	19574	56	19636	56	19698	57	19753	57
19387	316	19463	317	19575	56	19637	56	19699	57	19754	57
19388	316	19464	317	19575	56	19638	56	19700	57	19755	57
19389	316	19465	317	19576	56	19639	56	19701	57	19756	57
19390	316	19469	317	19577	56	19640	56	19701	57	19757	57
19391	316	19470	201	19578	56	19640	56	19702	57	19758	57
19392	316	19470	251	19579	56	19641	56	19703	57	19758	57
19393	317	19472	202	19580	56	19642	56	19703	57	19759	57

broj artikla	strana	broj artikla	strana	broj artikla	strana	broj artikla	strana	broj artikla	strana	broj artikla	strana
19760	57	20300	59	20489	61	20751	67	20896	63	21110	75
19761	57	20305	59	20490	61	20752	67	20897	63	21111	75
19762	57	20310	59	20491	61	20753	67	20898	63	21112	75
19763	57	20311	59	20492	61	20754	67	20899	63	21115	75
19763	57	20315	60	20493	61	20755	67	20901	64	21118	75
19764	57	20316	59	20494	61	20756	67	20905	64	21123	75
19765	57	20317	59	20495	61	20757	67	20910	64	21130	75
19766	57	20320	60	20496	61	20758	67	20911	63	21135	75
19767	57	20321	60	20508	67	20759	67	20912	63	21140	75
19768	57	20333	58	20510	67	20760	67	20913	63	21150	75
19768	57	20334	58	20511	67	20761	67	20915	63	21180	75
19769	57	20335	58	20512	67	20762	67	20916	63	21190	75
19770	57	20336	58	20513	67	20764	67	20917	63	21192	77
19771	57	20337	58	20514	67	20765	67	20918	63	21194	77
19772	57	20338	58	20515	67	20766	67	20919	63	21195	75
19772	57	20340	60	20516	67	20767	67	20920	63	21200	74
19773	57	20350	202	20520	67	20768	67	20921	63	21201	74
19774	57	20360	139	20521	67	20769	67	20922	63	21203	74
19775	57	20361	139	20522	67	20770	67	20923	63	21204	74
19776	57	20363	180	20523	67	20771	67	20924	63	21205	74
19776	57	20364	180	20524	67	20772	67	20932	69	21209	74
19777	57	20365	29	20525	67	20773	67	20936	69	21210	75
19778	57	20379	29	20526	67	20774	67	20937	69	21211	75
19779	57	20380	60	20673	67	20775	67	20938	69	21212	75
19780	57	20381	64	20674	67	20776	67	20939	69	21215	75
19781	57	20385	62	20675	67	20777	67	20940	69	21218	75
19781	57	20386	62	20676	67	20778	67	20941	69	21219	75
19782	57	20387	62	20677	67	20779	67	20942	69	21220	75
19783	57	20390	62	20678	67	20780	67	20943	69	21223	75
19783	57	20391	62	20680	67	20781	67	20944	69	21224	75
19784	57	20394	62	20682	67	20782	67	20945	69	21230	74
19785	57	20395	62	20684	67	20783	67	20946	69	21231	74
19786	57	20396	62	20685	67	20784	67	20947	69	21234	74
19786	57	20397	62	20686	67	20785	67	20948	69	21235	74
19787	57	20400	58	20687	67	20786	67	20949	69	21238	74
19788	57	20401	58	20688	67	20787	67	20950	68	21301	75
19789	57	20402	58	20690	67	20788	67	20952	68	21303	75
19790	57	20403	58	20691	67	20789	67	20954	68	21306	77
19791	57	20404	58	20692	67	20790	67	20956	69	21308	77
19792	57	20405	58	20694	67	20791	67	20957	63	21311	75
19793	57	20406	58	20696	67	20792	67	20958	63	21312	75
19794	57	20407	58	20697	67	20793	67	20960	29	21315	75
19795	57	20408	58	20698	67	20794	67	20961	29	21318	75
19796	57	20409	58	20724	63	20795	67	20963	29	21323	75
19797	57	20410	58	20725	63	20796	67	20965	29	21324	75
19798	57	20411	58	20726	63	20797	67	20966	29	21326	75
19799	57	20412	58	20727	63	20798	67	20967	166	21327	75
19800	57	20413	58	20728	63	20799	67	20968	166	21411	75
19801	57	20414	58	20729	63	20805	68	20970	202	21412	75
19802	57	20415	58	20730	63	20820	68	20971	202	21415	75
19841	58	20416	58	20731	63	20825	67	20972	202	21418	75
19842	58	20417	58	20732	63	20855	67	20973	202	21423	75
19845	58	20418	58	20733	63	20861	67	20980	63	21424	75
19885	58	20419	58	20734	63	20862	67	20981	63	21425	76
19895	58	20420	58	20735	63	20870	67	20982	63	21426	76
20210	64	20421	58	20736	63	20871	67	20983	63	21427	76
20220	57	20422	58	20737	63	20872	67	20984	63	21428	76
20225	57	20423	58	20738	63	20873	67	20990	69	21430	76
20230	57	20424	58	20739	63	20874	67	20991	69	21431	76
20235	57	20425	58	20740	63	20875	67	20992	69	21432	76
20240	57	20426	58	20741	63	20876	67	20996	68	21435	76
20245	57	20427	58	20742	150	20877	67	20997	69	21436	76
20250	57	20428	58	20743	29	20878	67	20999	68	21437	76
20255	57	20429	58	20743	149	20879	67	21010	75	21440	64
20260	57	20430	58	20744	29	20880	67	21011	75	21441	64
20270	57	20450	64	20745	29	20881	67	21012	75	21442	64
20280	57	20460	64	20748	67	20890	68	21015	75	21443	64
20290	57	20487	61	20749	67	20891	68	21018	75	21444	64
20296	57	20488	61	20750	67	20895	68	21023	75	21445	64

broj artikla	strana	broj artikla	strana	broj artikla	strana	broj artikla	strana	broj artikla	strana	broj artikla	strana
21446	64	21803	78	22012	81	22083	82	22170	189	22277	76
21450	66	21804	78	22013	81	22084	82	22171	189	22280	76
21451	66	21805	78	22014	81	22085	82	22172	189	22281	76
21452	66	21806	78	22015	81	22086	187	22173	189	22285	76
21453	66	21807	65	22016	81	22087	83	22174	189	22286	76
21454	66	21807	78	22017	81	22088	82	22178	188	22294	76
21530	64	21808	65	22018	81	22090	82	22180	188	22300	86
21531	63	21808	78	22019	81	22091	83	22181	188	22301	86
21532	63	21809	79	22020	81	22092	83	22182	188	22302	86
21533	63	21810	84	22021	81	22093	83	22183	188	22303	86
21534	63	21811	84	22022	81	22095	82	22184	188	22305	86
21535	63	21812	84	22023	81	22096	84	22185	188	22307	86
21536	63	21813	84	22024	81	22097	84	22186	188	22309	86
21540	66	21814	84	22025	81	22098	84	22188	189	22310	86
21541	66	21831	84	22026	81	22099	84	22189	189	22311	86
21701	84	21832	84	22027	81	22100	85	22190	189	22312	86
21702	84	21834	84	22028	81	22101	85	22196	189	22313	86
21703	84	21850	85	22029	81	22102	85	22197	189	22314	86
21704	84	21851	85	22030	81	22103	85	22198	189	22315	86
21705	84	21852	85	22031	81	22104	85	22199	189	22316	86
21706	84	21853	85	22032	82	22105	85	22200	70	22317	86
21709	84	21854	85	22033	187	22106	85	22201	70	22318	86
21715	84	21855	85	22034	187	22107	85	22202	189	22319	86
21716	84	21856	85	22035	187	22108	85	22203	189	22320	86
21717	84	21857	85	22036	187	22109	85	22204	189	22322	86
21718	84	21858	85	22037	80	22110	85	22205	189	22324	86
21719	84	21859	85	22038	80	22111	85	22206	188	22326	86
21720	84	21860	85	22039	81	22112	85	22207	188	22328	86
21721	84	21861	85	22040	81	22113	85	22208	188	22329	86
21724	84	21862	85	22041	83	22115	85	22209	188	22332	86
21732	84	21863	85	22042	83	22116	85	22211	77	22333	86
21734	84	21864	85	22043	83	22117	85	22212	77	22335	86
21735	84	21900	80	22044	83	22119	85	22215	77	22337	86
21736	84	21901	80	22045	84	22120	293	22216	77	22340	86
21737	84	21902	80	22046	84	22121	293	22217	77	22343	86
21740	84	21903	80	22047	84	22122	293	22218	77	22345	86
21741	84	21904	80	22048	84	22123	293	22219	77	22350	86
21742	84	21905	80	22049	84	22124	293	22220	77	22351	86
21743	84	21906	80	22050	84	22125	293	22222	77	22355	86
21744	84	21907	80	22051	84	22126	293	22224	77	22357	86
21750	84	21908	80	22052	84	22129	293	22225	77	22365	86
21751	84	21909	81	22053	84	22130	293	22228	77	22370	86
21752	84	21910	81	22054	84	22132	293	22229	77	22398	86
21753	84	21911	80	22055	84	22133	293	22230	77	22399	86
21754	84	21912	80	22056	84	22134	293	22232	77	22510	56
21760	79	21913	80	22057	84	22135	350	22234	77	22515	56
21761	79	21914	80	22058	81	22136	350	22236	77	22520	56
21762	79	21920	80	22059	81	22137	350	22238	77	22525	56
21763	79	21925	80	22060	83	22138	350	22240	77	22530	56
21764	79	21926	80	22061	83	22140	79	22242	77	22532	56
21780	79	21930	82	22062	83	22141	79	22244	77	22535	56
21781	79	21931	82	22063	83	22142	79	22246	77	22540	56
21782	79	21935	82	22064	83	22143	79	22248	77	22542	56
21783	79	21936	82	22065	83	22145	79	22251	77	22545	56
21784	79	21937	82	22066	83	22146	79	22252	77	22548	56
21786	79	21940	82	22067	85	22147	79	22253	77	22550	56
21787	79	21941	82	22070	83	22148	79	22254	77	22555	56
21788	79	21950	81	22071	83	22150	79	22255	77	22560	56
21789	79	22001	80	22072	83	22151	79	22258	76	22565	56
21790	79	22002	80	22073	83	22155	79	22259	76	22568	56
21792	79	22003	80	22074	83	22156	79	22260	76	22570	56
21793	79	22004	80	22075	85	22158	187	22263	76	22575	56
21794	79	22005	80	22076	85	22159	187	22264	76	22580	56
21795	79	22006	80	22077	85	22160	83	22266	76	22585	56
21796	79	22007	80	22078	187	22161	83	22269	76	22590	56
21798	79	22008	80	22079	187	22162	83	22270	76	22595	56
21800	78	22009	80	22080	187	22163	83	22273	76	22600	56
21801	78	22010	80	22081	187	22164	83	22274	76	22602	56
21802	78	22011	80	22082	187	22167	83	22275	76	22605	56

broj artikla	strana	broj artikla	strana	broj artikla	strana	broj artikla	strana	broj artikla	strana	broj artikla	strana
22610	56	23658	209	23973	183	24111	190	24197	93	24676	72
22615	56	23660	210	23974	183	24114	191	24301	90	24677	72
22620	56	23661	209	23975	183	24115	191	24302	90	24678	72
22625	56	23664	209	23976	183	24118	93	24303	90	24680	276
22630	56	23670	203	23977	183	24119	93	24304	90	24690	202
22701	82	23671	203	23978	183	24120	93	24305	90	24691	202
22702	82	23672	203	23979	183	24121	190	24306	90	24695	202
22703	82	23673	203	23985	183	24122	190	24308	90	24700	72
22704	82	23674	203	23986	183	24124	190	24310	90	24701	72
22705	82	23675	203	23987	183	24125	190	24312	91	24702	72
22706	82	23676	203	23988	183	24126	190	24313	91	24703	72
22707	82	23677	203	23989	183	24128	193	24314	91	24704	72
23270	239	23678	203	24000	183	24130	192	24315	91	24705	72
23400	212	23679	203	24001	183	24131	192	24316	91	24706	65
23401	212	23680	203	24005	183	24132	134	24320	87	24710	73
23402	212	23681	203	24007	182	24133	192	24321	87	24712	65
23406	212	23682	203	24008	183	24134	191	24322	87	24713	65
23407	212	23683	203	24010	182	24135	192	24325	91	24714	65
23410	212	23684	203	24015	182	24136	192	24410	60	24715	65
23411	212	23685	203	24017	182	24137	192	24411	60	24716	65
23412	212	23730	168	24020	182	24140	192	24412	60	24717	69
23415	212	23731	168	24030	182	24141	192	24415	65	24718	69
23416	212	23732	168	24035	183	24142	192	24419	60	24719	69
23417	212	23734	168	24036	183	24143	191	24420	60	24720	65
23420	205	23735	168	24038	183	24144	191	24422	60	24721	65
23506	204	23736	168	24039	183	24145	191	24425	60	24722	65
23507	204	23760	185	24040	183	24147	191	24429	60	24723	69
23508	204	23761	185	24041	183	24148	192	24432	60	24725	70
23515	204	23762	185	24042	183	24149	191	24435	60	24726	70
23520	204	23763	185	24043	183	24150	192	24437	60	24727	290
23525	204	23764	185	24045	89	24151	192	24444	60	24728	290
23530	204	23800	184	24050	91	24152	193	24451	60	24729	290
23531	204	23840	322	24055	88	24152	315	24457	60	24730	69
23551	204	23845	323	24055	277	24153	190	24464	60	24731	69
23560	204	23846	323	24060	88	24155	194	24468	60	24732	69
23561	204	23847	323	24061	88	24156	194	24476	60	24734	73
23562	204	23875	223	24062	88	24158	194	24483	60	24735	70
23563	204	23875	357	24063	88	24159	194	24620	71	24736	70
23564	204	23904	185	24064	88	24159	293	24621	71	24737	70
23565	204	23906	185	24065	88	24160	93	24622	71	24738	70
23566	204	23908	185	24066	88	24161	93	24623	71	24739	70
23570	203	23910	185	24067	88	24162	93	24624	71	24740	70
23571	203	23912	185	24068	88	24163	93	24627	71	24741	70
23572	203	23914	185	24069	88	24164	93	24630	71	24743	70
23573	203	23920	184	24070	88	24165	93	24633	71	24745	70
23574	203	23922	184	24071	88	24166	93	24636	71	24746	70
23585	203	23923	184	24072	88	24167	93	24638	71	24747	70
23587	203	23924	184	24073	88	24168	93	24640	71	24748	70
23589	203	23925	184	24074	88	24169	93	24642	71	24749	70
23591	203	23927	184	24075	88	24170	190	24643	71	24750	61
23595	204	23928	184	24076	88	24171	192	24647	79	24751	61
23598	204	23945	184	24077	88	24173	192	24648	79	24752	290
23600	205	23950	183	24078	88	24174	194	24649	79	24753	290
23601	205	23951	183	24080	89	24175	194	24650	72	24755	66
23602	205	23952	183	24081	89	24176	194	24651	71	24756	66
23605	205	23953	183	24082	89	24177	194	24652	71	24757	69
23607	205	23954	183	24083	89	24178	194	24655	73	24758	69
23620	205	23955	183	24084	89	24180	93	24658	73	24759	69
23625	203	23960	185	24085	89	24181	194	24661	72	24760	72
23626	203	23961	185	24086	89	24185	93	24663	72	24761	72
23628	203	23962	185	24087	89	24186	93	24665	82	24762	72
23630	203	23963	185	24098	89	24187	93	24666	82	24763	72
23632	203	23964	185	24099	89	24188	93	24667	82	24764	72
23635	203	23965	185	24100	190	24189	93	24670	72	24765	72
23637	204	23966	185	24102	190	24190	194	24671	72	24766	72
23650	210	23967	185	24104	190	24190	293	24672	72	24767	72
23652	208	23970	183	24108	93	24192	93	24673	72	24768	72
23655	210	23971	183	24109	93	24195	93	24674	72	24769	72
23657	208	23972	183	24110	190	24196	93	24675	72	24770	70

broj artikla	strana	broj artikla	strana	broj artikla	strana	broj artikla	strana	broj artikla	strana	broj artikla	strana
24771	70	25206	305	28032	11	31082	245	31502	252	32166	248
24772	70	25212	305	28035	13	31091	244	31503	252	32167	248
24773	70	25215	305	28040	12	31101	244	31505	247	32168	248
24774	70	25220	305	28045	12	31111	244	31506	247	32169	248
24775	71	25224	305	28050	14	31121	244	31507	247	32170	247
24776	72	25230	305	28055	14	31131	244	31510	247	32171	248
24777	71	25240	305	28060	17	31132	244	31511	247	32172	248
24778	71	25248	305	28061	17	31140	244	31512	247	32173	247
24779	72	25260	305	28065	17	31141	244	31513	247	32174	248
24780	73	25296	305	28070	10	31142	244	31514	247	32176	248
24781	73	25350	305	28075	15	31143	244	31515	247	32186	248
24782	73	25369	305	28076	18	31144	244	31517	247	32196	248
24783	73	25370	305	28080	19	31145	244	31519	252	32206	248
24784	73	25371	305	28081	19	31146	244	31520	249	32216	248
24785	73	25372	305	28083	19	31148	244	31521	249	32226	248
24786	73	25373	305	28085	19	31150	245	31522	249	32234	248
24787	73	25374	305	28086	19	31151	245	31523	249	32240	248
24788	73	25376	305	28090	20	31155	245	31524	249	32265	250
24789	73	25378	305	28101	21	31218	247	31541	249	32268	251
24790	72	25379	305	28102	20	31220	246	31551	249	32269	251
24791	72	25380	305	28103	20	31221	246	31552	249	32270	250
24792	72	25400	305	28104	21	31222	246	31553	249	32273	250
24793	72	25410	305	28210	28	31231	246	31555	249	32283	250
24794	72	26028	111	28213	28	31232	246	31556	249	32285	250
24795	71	26201	113	28215	27	31233	246	31557	249	32293	250
24796	72	26203	112	28218	28	31234	246	31558	249	32295	251
24797	71	26204	113	28220	25	31235	246	31559	249	32296	251
24798	73	26205	112	28221	23	31270	246	31601	253	32297	251
24799	71	26209	114	28223	28	31271	246	31602	253	32298	251
25001	305	26211	113	28225	24	31280	246	31603	253	32301	251
25002	305	26216	114	28228	28	31281	246	31610	249	32302	251
25003	305	26217	114	28229	28	31320	247	31641	253	32311	255
25004	305	26218	114	28230	26	31322	247	31651	253	32312	254
25005	305	26219	114	28233	28	31330	246	31655	253	32313	251
25006	305	26520	115	28240	36	31332	246	32001	250	32314	254
25009	305	26521	115	28267	29	31334	246	32002	250	32315	255
25012	305	26705	228	28275	50	31340	246	32003	250	32316	255
25015	305	26706	228	28278	50	31341	246	32013	250	32317	254
25016	305	26707	228	28280	50	31343	246	32014	250	32318	255
25020	305	26720	228	28282	50	31360	246	32015	250	32319	255
25024	305	26721	228	28340	37	31362	246	32016	250	32320	254
25025	305	26722	228	28342	37	31380	246	32018	250	32321	255
25030	305	26730	272	28345	37	31382	246	32020	250	32322	255
25040	305	26731	272	28346	37	31390	246	32021	250	32323	255
25048	305	26735	272	30003	256	31392	246	32022	253	32324	255
25060	305	26736	272	30003	259	31400	246	32023	253	32325	255
25096	305	26740	273	30004	256	31402	246	32024	250	32326	255
25150	305	26775	292	30004	259	31403	246	32026	250	32327	254
25153	305	26780	273	30005	256	31404	246	32037	251	32328	255
25155	305	26781	273	30005	259	31452	253	32038	251	32329	254
25160	305	26782	273	30007	256	31453	253	32040	253	32330	255
25162	305	26783	273	30007	259	31454	253	32041	253	32331	255
25163	305	26973	216	31005	245	31455	247	32042	253	32332	254
25164	305	26974	216	31006	245	31456	247	32043	253	32333	254
25167	305	26975	216	31007	245	31461	248	32044	253	32335	255
25169	305	26976	216	31008	245	31467	248	32050	253	32337	254
25170	305	26977	216	31009	245	31468	248	32051	253	32338	254
25171	305	28000	4	31011	245	31471	248	32052	253	33168	254
25179	305	28001	5	31021	245	31481	248	32053	253	33275	296
25180	305	28002	5	31031	245	31491	248	32060	250	34005	256
25181	305	28003	6	31041	245	31493	248	32062	250	34006	256
25182	305	28004	6	31051	245	31494	248	32064	250	34007	256
25183	305	28005	7	31052	245	31495	248	32066	250	34027	255
25184	305	28006	7	31053	245	31496	248	32089	251	34028	255
25186	305	28007	8	31061	245	31497	252	32161	248	34033	260
25188	305	28008	8	31062	245	31498	248	32162	248	34041	256
25189	305	28021	9	31071	245	31499	248	32163	248	34051	256
25190	305	28025	9	31072	245	31500	248	32164	248	34053	256
25195	305	28030	11	31081	245	31501	252	32165	248	34061	256

broj artikla	strana	broj artikla	strana	broj artikla	strana	broj artikla	strana	broj artikla	strana	broj artikla	strana
34071	256	34405	258	35082	263	35345	40	36130	277	37115	291
34081	256	34406	259	35085	262	35345	286	36136	277	37117	278
34091	256	34407	259	35086	262	35346	41	36138	277	37119	291
34101	256	34409	259	35087	262	35346	288	36139	277	37120	291
34111	256	34410	259	35091	262	35347	41	36140	277	37121	296
34115	256	34411	259	35092	262	35347	288	36145	274	37122	296
34116	256	34412	259	35093	262	35348	40	36160	274	37123	364
34117	256	34413	259	35094	263	35348	286	36175	274	37124	364
34121	256	34414	259	35095	263	35360	46	36190	274	37125	282
34122	256	34415	258	35096	263	35361	46	36191	274	37126	282
34132	256	34416	258	35103	264	35362	46	36195	277	37127	282
34142	256	34417	259	35113	264	35500	266	36199	274	37129	364
34152	256	34418	259	35123	264	35501	266	36200	274	37130	281
34153	256	34419	258	35125	264	35502	266	36300	209	37131	281
34154	256	34420	258	35126	264	35503	266	36308	292	37132	281
34155	256	34421	259	35127	264	35504	266	36310	273	37135	231
34156	256	34422	259	35142	262	35505	266	36312	292	37139	231
34157	256	34423	259	35300	38	35506	266	36318	283	37140	231
34158	256	34424	259	35300	261	35507	266	36319	283	37141	231
34159	256	34425	259	35305	39	35508	266	36325	283	37142	231
34160	256	34426	259	35305	262	35510	266	36326	16	37143	231
34200	252	34428	259	35310	38	35511	266	36326	283	37144	231
34201	252	34429	259	35310	261	35512	266	36328	16	37145	231
34202	252	34439	258	35311	38	35514	266	36329	16	37148	282
34203	252	34440	258	35311	261	35515	266	36410	208	37149	282
34221	260	34441	258	35315	39	35516	266	37005	302	37150	282
34223	260	34442	258	35315	262	35517	266	37006	279	37151	282
34231	260	34443	258	35316	38	35518	267	37006	279	37152	282
34235	260	34445	258	35316	261	35519	267	37007	279	37153	282
34237	260	34446	258	35317	38	35524	267	37007	279	37154	282
34238	260	34447	258	35317	261	35525	267	37008	279	37155	280
34241	260	34448	259	35318	38	35527	267	37009	279	37156	280
34243	260	34449	258	35318	261	35532	267	37011	278	37157	280
34251	260	34450	258	35319	38	35533	267	37012	279	37158	282
34261	260	34451	258	35319	261	35539	267	37021	278	37162	281
34262	260	34452	259	35320	50	35540	267	37025	278	37166	273
34265	260	34453	258	35322	50	35542	267	37025	278	37170	281
34271	252	34454	258	35323	42	35552	267	37026	278	37171	281
34272	252	34455	259	35323	289	35553	267	37026	278	37172	281
34273	252	34456	259	35325	42	35555	267	37028	278	37173	282
34274	252	34457	259	35325	289	35603	269	37028	278	37174	282
34275	252	34458	259	35326	42	35604	269	37029	278	37175	281
34276	252	34480	258	35326	289	35605	269	37029	278	37176	281
34280	252	34481	258	35327	42	35833	52	37031	253	37177	282
34281	252	34482	258	35327	289	35845	52	37041	253	37178	282
34282	252	34485	258	35328	42	35850	52	37050	278	37185	281
34283	252	34486	258	35328	42	36014	276	37051	253	37186	281
34284	252	34490	259	35328	289	36024	276	37052	278	37187	281
34285	252	34491	259	35328	289	36034	276	37053	278	37188	281
34300	292	34496	259	35329	42	36035	276	37054	278	37189	281
34301	252	34500	260	35329	42	36036	276	37055	278	37190	281
34303	292	35006	263	35329	289	36046	276	37065	284	37192	281
34304	252	35007	263	35329	289	36056	277	37066	284	37195	282
34305	252	35011	264	35330	40	36057	277	37067	284	37196	282
34305	292	35012	263	35330	287	36058	277	37068	284	37197	282
34306	252	35013	263	35331	41	36059	277	37069	284	37198	282
34306	292	35015	264	35331	288	36076	275	37070	284	37199	282
34307	252	35021	264	35332	41	36077	275	37094	284	37200	280
34307	292	35023	262	35332	288	36080	275	37095	284	37201	280
34308	252	35038	262	35333	41	36081	275	37096	284	37202	280
34308	292	35048	264	35333	288	36082	275	37097	284	37203	280
34315	293	35058	262	35334	41	36085	275	37098	284	37204	280
34316	131	35059	263	35334	288	36086	275	37101	253	37205	280
34316	293	35068	264	35335	42	36087	275	37102	280	37210	280
34400	258	35069	263	35335	289	36102	275	37105	280	37211	280
34401	258	35070	263	35336	41	36103	275	37106	280	37212	280
34402	259	35078	263	35336	288	36105	275	37107	280	37216	291
34403	259	35079	263	35344	41	36126	277	37111	253	37217	291
34404	258	35081	263	35344	287	36128	277	37114	291	37218	291

broj artikla	strana	broj artikla	strana	broj artikla	strana	broj artikla	strana	broj artikla	strana	broj artikla	strana
37220	280	37344	236	38022	299	38949	224	39217	290	42179	353
37230	292	37345	236	38024	297	38950	290	39218	290	42180	354
37231	292	37350	235	38025	298	38951	290	39219	290	42181	354
37232	292	37500	267	38026	279	38952	290	39238	292	42182	354
37233	292	37501	267	38027	297	38953	290	39240	290	42185	354
37234	292	37505	267	38028	297	38954	290	39241	290	42186	354
37235	292	37506	267	38030	299	38955	224	39242	290	42187	354
37236	291	37509	268	38031	299	38956	224	39243	290	42188	354
37237	291	37510	268	38032	297	38957	224	39244	290	42190	224
37238	291	37511	268	38042	279	38958	224	39245	292	42190	354
37239	291	37512	268	38045	279	38959	224	40050	353	42201	355
37243	303	37515	268	38050	223	38960	224	40051	353	42202	355
37244	303	37516	268	38052	223	38961	224	40052	353	42203	355
37245	303	37517	268	38054	223	38963	226	40053	353	42207	355
37246	303	37518	268	38055	223	38964	225	40054	353	42208	355
37247	303	37527	268	38060	223	38965	225	40055	353	42209	355
37248	303	37530	268	38063	223	38966	225	40056	353	42210	355
37250	303	37532	268	38065	223	38968	224	40057	353	42211	355
37251	303	37533	268	38095	223	38969	226	40058	353	42212	355
37252	303	37539	269	38096	223	38970	290	40059	353	42213	355
37253	303	37541	269	38097	223	38971	290	40060	353	42214	355
37255	225	37545	307	38895	284	38972	226	40075	353	42217	355
37256	225	37546	307	38896	284	38973	226	40076	353	42218	355
37257	225	37549	210	38899	284	38975	226	40077	353	42219	355
37258	225	37553	212	38900	284	38980	224	40100	352	42220	355
37259	225	37560	209	38901	285	38981	224	40120	352	42221	355
37263	225	37564	269	38902	285	38985	226	41050	352	42228	355
37264	225	37570	192	38903	285	38990	225	41080	352	42229	355
37266	225	37570	209	38904	285	38991	225	41081	352	42230	355
37267	225	37611	53	38905	285	38995	225	41082	352	42244	355
37268	225	37615	53	38906	285	39000	296	41083	352	42248	355
37270	225	37616	53	38907	284	39001	296	41100	352	42249	355
37271	225	37647	218	38908	284	39002	296	41101	352	42251	355
37272	225	37660	306	38909	284	39003	296	41102	352	42252	355
37273	225	37730	53	38910	285	39005	296	41103	352	42253	355
37275	225	37731	53	38911	285	39010	296	41120	352	42255	355
37280	226	37732	53	38912	285	39012	296	41121	352	42256	355
37281	226	37733	53	38913	285	39014	296	41122	352	42257	355
37285	282	37740	53	38914	285	39020	296	41123	352	42260	355
37286	282	37741	53	38915	285	39021	296	41150	352	42261	355
37287	282	37744	53	38916	285	39045	296	41151	352	42312	291
37288	282	37745	53	38917	285	39065	296	41152	352	42312	354
37289	282	37746	53	38918	285	39090	296	41153	352	42365	222
37290	303	37747	53	38919	279	39145	296	42101	352	42366	222
37291	303	37750	53	38920	279	39165	296	42102	352	42367	222
37295	226	37751	53	38923	279	39190	296	42103	352	42368	222
37296	226	37760	53	38924	225	39192	296	42115	291	42420	291
37297	226	37761	53	38925	224	39192	323	42120	291	43050	358
37300	235	38000	298	38926	226	39193	296	42150	353	43058	358
37301	235	38001	297	38927	224	39193	323	42151	353	43060	358
37302	235	38002	298	38928	225	39194	223	42152	353	43068	358
37303	235	38003	298	38929	225	39195	223	42153	353	43071	358
37308	236	38004	299	38930	226	39196	223	42155	353	43072	358
37309	236	38005	299	38931	224	39197	223	42156	353	43077	358
37310	235	38006	298	38932	224	39198	223	42157	353	43082	358
37311	235	38007	298	38933	226	39199	223	42158	353	43083	358
37317	313	38008	298	38934	225	39200	223	42160	353	43084	358
37320	235	38009	298	38935	226	39201	223	42161	353	43086	358
37321	235	38010	298	38937	226	39202	223	42162	353	43087	359
37325	234	38012	297	38939	226	39203	223	42163	353	43089	359
37326	234	38013	297	38940	226	39204	223	42170	354	43090	359
37328	234	38014	299	38941	226	39205	223	42171	354	43094	359
37330	234	38014	299	38942	225	39206	290	42172	354	43097	358
37331	234	38015	299	38943	226	39207	290	42173	354	43098	359
37332	234	38016	299	38944	224	39208	290	42174	354	43099	359
37340	236	38017	299	38945	224	39210	290	42175	353	43300	347
37341	236	38018	299	38946	224	39212	290	42176	353	43301	347
37342	236	38020	298	38947	224	39214	290	42177	353	44041	322
37343	236	38021	299	38948	224	39216	290	42178	353	44042	322

broj artikla	strana	broj artikla	strana	broj artikla	strana	broj artikla	strana	broj artikla	strana	broj artikla	strana
44043	322	45034	319	45099	310	45178	333	45268	335	45391	324
44050	322	45035	318	45100	334	45179	331	45269	335	45392	324
44053	319	45036	322	45101	334	45180	327	45270	39	45393	324
44950	131	45038	319	45102	334	45181	327	45271	39	45394	324
44950	315	45039	319	45104	334	45182	333	45280	334	45395	324
44955	319	45040	319	45105	334	45183	333	45283	334	45396	325
44960	323	45041	319	45106	334	45184	331	45285	334	45397	325
44965	338	45042	319	45107	334	45185	331	45286	334	45398	325
44970	313	45043	323	45108	334	45186	331	45287	334	45399	325
44971	313	45044	322	45110	326	45187	332	45289	329	45400	325
44972	310	45045	136	45111	327	45190	332	45290	329	45401	325
44980	310	45045	320	45112	327	45191	332	45291	329	45450	357
44980	310	45046	136	45113	327	45192	332	45292	329	45451	357
44980	311	45046	320	45114	327	45193	332	45293	329	45452	357
44981	310	45047	323	45115	327	45194	332	45294	328	45453	357
44981	310	45048	136	45116	326	45195	332	45295	328	45460	357
44981	311	45048	312	45117	326	45196	332	45296	328	45461	357
44981	311	45048	320	45118	326	45197	332	45297	328	45462	357
44982	310	45049	322	45120	327	45198	332	45298	328	45463	357
44982	310	45050	338	45122	327	45199	332	45299	328	45465	357
44982	311	45051	338	45123	326	45200	332	45300	333	45466	357
44983	310	45052	338	45124	326	45203	332	45301	333	45467	357
44983	310	45053	339	45125	326	45204	332	45320	339	45470	357
44983	311	45054	339	45126	326	45206	332	45321	339	45471	226
44984	311	45055	339	45130	329	45211	332	45323	337	45471	323
44984	312	45056	318	45131	329	45213	328	45323	348	45472	323
44984	312	45057	318	45132	329	45214	327	45325	337	45473	323
44985	311	45058	318	45133	329	45215	329	45326	337	45480	357
44985	312	45059	318	45134	330	45216	328	45326	337	45485	357
44991	311	45060	193	45135	329	45217	329	45327	337	45490	314
44992	311	45060	315	45136	329	45218	328	45328	337	45496	357
44995	314	45061	193	45137	329	45219	329	45329	337	45497	357
44996	312	45061	315	45138	328	45220	334	45330	337	45498	357
44997	312	45062	193	45139	328	45221	334	45330	350	45499	357
44998	312	45062	315	45140	328	45222	334	45331	337	45500	321
44999	313	45063	310	45141	328	45223	334	45331	350	45502	321
45000	314	45065	318	45142	328	45224	334	45341	333	45503	321
45001	314	45066	318	45143	328	45225	334	45342	333	45505	321
45002	314	45067	318	45144	329	45226	334	45343	333	45506	321
45003	314	45068	136	45145	329	45227	334	45344	333	45508	321
45005	314	45068	312	45146	330	45228	334	45345	333	45509	321
45006	314	45068	320	45147	331	45229	334	45346	333	45511	321
45007	314	45069	131	45150	331	45239	336	45347	333	45512	321
45008	314	45069	315	45151	331	45240	336	45348	333	45513	321
45009	314	45070	340	45152	330	45241	336	45349	333	45515	321
45010	312	45071	338	45153	330	45242	336	45350	333	45516	321
45011	313	45073	136	45154	330	45244	335	45351	333	45517	321
45012	313	45073	320	45155	330	45245	335	45352	333	45518	321
45014	312	45074	323	45156	331	45246	335	45353	333	45519	321
45015	313	45079	319	45158	330	45247	335	45354	333	45520	321
45016	313	45080	319	45159	331	45248	335	45370	136	45521	321
45017	311	45081	131	45160	331	45249	335	45370	320	45522	321
45018	312	45081	315	45161	331	45250	335	45372	325	45523	321
45019	312	45082	131	45162	330	45251	335	45372	333	45524	321
45020	310	45082	315	45163	330	45253	335	45373	325	45525	321
45021	312	45083	131	45164	331	45254	335	45373	333	45526	321
45023	310	45083	315	45167	330	45256	335	45374	325	45527	321
45025	313	45084	131	45168	331	45257	335	45374	333	45528	321
45026	312	45084	315	45169	331	45260	335	45375	325	45529	321
45027	313	45085	319	45170	336	45261	335	45375	333	45530	321
45029	313	45086	323	45171	336	45262	335	45376	325	45531	321
45030	193	45088	311	45172	336	45262	335	45376	333	45532	321
45030	315	45089	311	45172	336	45263	335	45377	325	45533	321
45031	193	45093	323	45173	336	45263	335	45377	333	45534	321
45031	315	45094	311	45173	336	45265	335	45385	324	45535	322
45032	193	45095	310	45174	333	45266	335	45386	324	45540	321
45032	315	45096	310	45175	332	45267	335	45388	324	45541	321
45033	193	45097	311	45176	333	45267	335	45389	324	45542	321
45033	315	45098	310	45177	333	45268	335	45390	324	45543	321

broj artikla	strana	broj artikla	strana	broj artikla	strana	broj artikla	strana	broj artikla	strana	broj artikla	strana
45550	321	45660	322	48094	49	50544	233	51244	227	52055	307
45551	321	45661	322	48095	49	50549	232	51245	227	52060	307
45552	321	45662	322	48096	49	50550	230	51246	227	52065	307
45553	321	45663	322	48097	49	50551	230	51247	227	52070	300
45555	322	45664	322	48410	306	50553	230	51258	227	52071	300
45556	321	45670	322	48411	306	50554	230	51259	227	52075	300
45557	321	45671	322	48415	306	50555	233	51260	227	52076	300
45558	321	45672	322	48420	306	50556	230	51261	227	52077	300
45559	321	45673	322	48452	307	50557	232	51262	227	52078	300
45560	322	48001	48	48453	307	50558	232	51264	227	52101	349
45562	321	48002	48	48454	307	50559	230	51271	227	52102	349
45563	321	48004	47	48455	307	50560	230	51272	227	52103	349
45564	321	48005	47	48456	307	50562	230	51273	227	52104	349
45565	321	48006	47	48457	307	50563	230	51274	227	52105	349
45570	354	48007	47	48719	273	50564	230	51275	227	52108	348
45571	354	48008	49	48729	269	50570	230	51276	227	52109	349
45572	354	48009	49	48730	269	50571	230	51278	227	52113	349
45573	354	48010	48	48731	269	50585	233	51280	227	52114	349
45580	354	48011	48	50030	355	50585	303	51281	227	52115	349
45600	334	48013	15	50031	355	50586	233	51282	227	52116	349
45601	334	48013	48	50032	355	50586	303	51283	227	52119	348
45602	334	48015	47	50033	355	50587	233	51284	227	52126	350
45603	334	48020	46	50035	228	50587	303	51286	227	52130	280
45604	334	48021	46	50035	355	50588	233	51287	227	52135	348
45605	334	48022	46	50036	228	50588	303	51288	227	52160	349
45606	334	48030	47	50036	355	51100	228	51300	227	52161	349
45607	334	48031	48	50037	355	51102	228	51301	227	52162	349
45608	334	48032	48	50038	355	51103	228	51302	227	52163	349
45609	334	48033	48	50040	355	51104	228	51303	227	52164	349
45610	334	48034	48	50041	355	51105	228	51304	227	52168	348
45611	334	48036	47	50042	355	51106	228	51305	227	52173	348
45612	334	48037	47	50050	222	51107	228	51306	227	52175	348
45613	334	48040	48	50050	222	51108	228	51307	227	52176	348
45614	334	48041	48	50051	222	51109	228	51308	227	52185	349
45615	334	48042	48	50052	222	51110	228	51320	227	52186	349
45616	334	48043	48	50052	222	51111	228	51321	227	52187	349
45617	334	48046	46	50100	227	51120	228	51322	227	52188	349
45618	334	48046	49	50101	227	51121	228	51323	227	52189	349
45619	334	48047	46	50102	227	51122	228	51324	227	52190	349
45620	334	48047	49	50103	227	51123	228	51325	227	52191	349
45621	334	48050	49	50104	227	51124	228	51327	227	52192	349
45622	334	48051	49	50106	227	51125	228	51341	227	52193	349
45623	334	48054	49	50108	227	51126	228	51402	228	52194	349
45624	334	48055	49	50500	233	51127	228	51403	228	52195	349
45625	334	48056	49	50503	233	51130	228	51404	228	52196	349
45626	334	48057	49	50510	230	51131	228	51405	228	52197	348
45627	334	48060	49	50511	230	51132	228	51406	228	52198	348
45628	334	48061	49	50512	230	51196	228	51407	228	52202	300
45629	334	48062	49	50513	230	51197	228	51408	228	52203	300
45630	334	48063	49	50514	230	51198	228	51410	228	52204	300
45631	334	48064	49	50518	232	51199	228	51412	228	52205	300
45632	334	48065	49	50519	232	51204	227	51413	228	52206	300
45633	334	48066	49	50520	232	51205	227	51414	228	52207	300
45634	334	48067	49	50522	232	51206	227	51415	228	52208	300
45635	334	48068	49	50524	232	51207	227	51416	228	52212	300
45636	334	48070	49	50525	232	51208	227	51417	228	52213	300
45637	334	48071	49	50526	232	51209	227	51418	228	52214	300
45638	334	48072	49	50527	233	51210	227	51420	228	52215	300
45639	334	48075	49	50529	232	51211	227	51430	228	52216	300
45650	322	48076	49	50531	233	51212	227	51431	228	52217	300
45651	322	48077	49	50532	233	51220	227	51432	228	52218	300
45652	322	48080	49	50533	232	51221	227	51433	228	52220	300
45653	322	48081	49	50535	232	51222	227	51435	228	52283	300
45654	322	48085	49	50536	232	51225	227	51436	228	52284	300
45655	322	48086	49	50537	232	51226	227	51450	228	52285	300
45656	322	48087	49	50539	232	51227	227	52011	249	52286	300
45657	322	48090	49	50540	233	51241	227	52011	303	52288	300
45658	322	48091	49	50541	233	51242	227	52030	252	52305	301
45659	322	48093	49	50542	233	51243	227	52050	307	52306	301

broj artikla	strana	broj artikla	strana	broj artikla	strana	broj artikla	strana	broj artikla	strana	broj artikla	strana
52328	301	55356	229	61003	344	61098	345	61236	217	70025	44
52331	301	55357	229	61004	344	61098	351	61240	197	70026	44
52334	301	55358	229	61005	341	61111	346	61250	351	70030	44
52391	301	55359	229	61005	351	61112	346	61251	319	70031	44
52421	301	55360	229	61006	341	61114	346	61251	351	70032	44
52424	301	55361	229	61006	351	61120	346	61252	351	70033	44
52428	301	55362	229	61007	341	61121	346	61253	351	70035	44
52456	301	55400	356	61008	341	61130	338	61254	351	70036	44
52471	301	55401	356	61009	345	61131	338	61255	351	70037	44
52600	302	55402	356	61010	341	61132	339	61256	351	70040	43
52601	302	55403	356	61012	345	61133	339	61290	346	70060	44
52602	302	55404	356	61013	344	61134	339	61291	346	70061	44
52605	302	55405	356	61014	345	61135	339	61292	346	70062	44
52610	302	55406	356	61015	341	61141	339	61293	346	70063	44
52611	248	55420	356	61018	345	61142	340	61294	318	70064	43
52612	248	55421	356	61019	344	61143	340	61295	318	70065	44
52620	302	55422	356	61020	342	61144	340	61296	318	70066	43
52625	302	55423	356	61021	342	61145	340	61297	318	70070	44
52630	302	55424	356	61022	343	61146	340	61299	356	70075	44
52635	302	55425	356	61024	343	61150	338	61300	356	70090	45
52640	302	55429	356	61025	342	61155	341	61301	356	70091	45
52645	302	55430	356	61026	342	61156	341	61302	356	70092	45
52652	302	55431	356	61027	343	61157	341	61320	197	70093	45
52656	302	55432	356	61028	345	61158	341	61321	197	70094	45
52662	302	55433	356	61029	341	61161	344	61322	197	70095	45
52666	302	55436	356	61030	340	61162	344	61323	197	70096	45
52671	302	55437	356	61031	340	61163	344	61324	197	70098	210
52694	302	55450	356	61032	340	61164	345	61325	197	81011	361
52695	302	55452	356	61033	340	61165	345	61326	197	81012	361
54008	303	55453	356	61034	340	61166	345	61327	197	81013	361
55040	229	55454	356	61035	346	61169	251	61328	197	81014	361
55050	229	55455	356	61036	346	61171	350	61329	197	81015	361
55051	229	55456	356	61038	346	61172	348	61330	197	81016	361
55060	229	55457	356	61040	346	61172	350	61331	197	81022	361
55080	229	55460	356	61042	346	61173	350	61340	317	81023	361
55100	229	55461	356	61044	345	61174	350	61341	317	81024	361
55120	229	55462	356	61045	340	61175	350	61342	317	81025	361
55140	229	55465	356	61046	340	61176	350	61343	317	81035	361
55160	229	55640	229	61047	340	61177	350	61344	317	81036	361
55180	229	55642	229	61048	340	61183	351	61345	317	81053	364
55181	229	55645	229	61050	342	61184	351	61346	317	81054	364
55200	229	55650	229	61050	351	61189	351	65062	307	81057	364
55201	229	60001	347	61051	342	61190	351	65063	307	81070	364
55220	229	60006	347	61051	351	61192	350	65064	307	81071	364
55221	229	60008	347	61052	343	61193	350	65065	307	81077	364
55240	229	60012	347	61052	351	61194	350	69900	294	81100	364
55300	229	60018	347	61053	343	61195	351	69901	294	81101	364
55315	229	60019	347	61054	343	61200	350	69902	294	81102	364
55316	229	60020	347	61056	342	61201	347	69903	294	81103	364
55317	229	60022	347	61057	342	61201	350	69904	295	81104	364
55318	229	60100	251	61058	343	61202	350	69905	294	81105	364
55319	229	60115	273	61059	343	61203	345	69906	294	81106	364
55331	229	60116	273	61060	340	61204	351	69907	295	81150	362
55332	229	60117	273	61061	340	61205	351	69908	295	81151	362
55333	229	60118	273	61062	340	61207	351	69909	295	81152	362
55334	229	60121	273	61063	340	61208	350	69910	295	81155	362
55335	229	60123	273	61067	346	61209	345	69911	295	81160	362
55336	229	60125	272	61068	346	61215	351	69912	295	81165	362
55337	229	60130	272	61069	346	61218	251	69914	294	81170	362
55339	229	60132	272	61070	346	61219	351	69917	295	81175	362
55340	229	60155	272	61077	351	61221	318	69918	294	81178	362
55341	229	60157	272	61079	351	61221	318	69919	294	81180	362
55342	229	60201	347	61079	351	61221	318	69920	295	81185	362
55350	229	60206	347	61085	319	61221	318	69923	295	81186	362
55351	229	60208	347	61088	342	61222	345	69928	295	81188	362
55352	229	60212	347	61089	342	61223	344	69930	296	81189	362
55353	229	61000	342	61090	343	61224	346	69931	296	81190	362
55354	229	61001	342	61097	344	61224	346	70020	44	81191	362
55355	229	61002	343	61097	351	61230	351	70021	44	81195	361

broj artikla	strana	broj artikla	strana	broj artikla	strana	broj artikla	strana	broj artikla	strana	broj artikla	strana
81196	361	81267	363	81337	363	81408	363	82103	307		
81197	361	81268	363	81338	363	81409	363	82104	307		
81200	363	81269	363	81339	363	81410	363	89775	51		
81201	363	81270	363	81340	363	81411	363	89970	51		
81202	363	81271	363	81341	363	81412	363	89973	51		
81203	363	81272	363	81342	363	81413	363	89975	51		
81204	363	81273	363	81343	363	81414	363	89980	51		
81205	363	81274	363	81344	363	81415	363	89985	51		
81206	363	81275	363	81345	363	81416	363	89987	51		
81207	363	81276	363	81346	363	81417	363	89988	51		
81208	363	81277	363	81347	363	81418	363	89989	51		
81209	363	81278	363	81348	363	81419	363	89990	51		
81210	363	81279	363	81349	363	81420	363	90070	278		
81211	363	81280	363	81350	363	81421	363	90071	278		
81212	363	81281	363	81351	363	81422	363	90072	278		
81213	363	81282	363	81352	363	81423	363	90191	56		
81214	363	81284	363	81353	363	81424	363	90192	57		
81215	363	81285	363	81354	363	81425	363	18610A	150		
81216	363	81286	363	81355	363	81426	363	18611A	150		
81217	363	81287	363	81356	363	81427	363	18612A	150		
81218	363	81288	363	81357	363	81428	363	18613A	150		
81219	363	81289	363	81358	363	81429	363	18614A	150		
81220	363	81290	363	81359	363	81430	363	18615A	150		
81221	363	81291	363	81360	363	81431	363	18632A	147		
81222	363	81292	363	81361	363	81432	363	18633A	147		
81223	363	81293	363	81362	363	81433	363	18636A	147		
81224	363	81294	363	81363	363	81434	363	18637A	147		
81225	363	81295	363	81364	363	81435	363	18638A	147		
81226	363	81296	363	81365	363	81436	363	18827A	147		
81227	363	81297	363	81366	363	81437	363	18828A	147		
81228	363	81298	363	81367	363	81438	363	18830A	147		
81229	363	81299	363	81370	363	81439	363	18831A	147		
81230	363	81300	363	81371	363	81440	363	81011A	361		
81231	363	81301	363	81372	363	81441	363	81011F	361		
81232	363	81302	363	81373	363	81442	363	81011G	361		
81233	363	81303	363	81374	363	81443	363	81011H	361		
81234	363	81304	363	81375	363	81444	363	81011R	361		
81235	363	81305	363	81376	363	81445	363	M90203	365		
81236	363	81306	363	81377	363	81447	363	M90204	365		
81237	363	81307	363	81378	363	81448	363	M90205	365		
81238	363	81308	363	81379	363	81449	363	M90206	365		
81239	363	81309	363	81380	363	81450	363	M90207	365		
81240	363	81310	363	81381	363	81451	363	M90210	365		
81241	363	81311	363	81382	363	81452	363	M90220	365		
81242	363	81312	363	81383	363	81453	363	M90221	365		
81243	363	81313	363	81384	363	81454	363	M90222	365		
81244	363	81314	363	81385	363	81455	363	M90400	365		
81245	363	81315	363	81386	363	81456	363	M90403	365		
81246	363	81316	363	81387	363	81457	363	M90519	365		
81247	363	81317	363	81388	363	81458	363				
81248	363	81318	363	81389	363	81459	363				
81249	363	81319	363	81390	363	81460	363				
81250	363	81320	363	81391	363	81461	363				
81251	363	81321	363	81392	363	81462	363				
81252	363	81322	363	81393	363	81463	363				
81253	363	81323	363	81394	363	81466	363				
81254	363	81324	363	81395	363	81467	363				
81255	363	81325	363	81396	363	81468	363				
81256	363	81326	363	81397	363	81469	363				
81257	363	81327	363	81398	363	81470	363				
81258	363	81328	363	81399	363	81471	363				
81259	363	81329	363	81400	363	81472	363				
81260	363	81330	363	81401	363	81473	363				
81261	363	81331	363	81402	363	81486	363				
81262	363	81332	363	81403	363	81600	364				
81263	363	81333	363	81404	363	81603	364				
81264	363	81334	363	81405	363	82100	307				
81265	363	81335	363	81406	363	82101	307				
81266	363	81336	363	81407	363	82102	307				

LISTA KORIŠĆENIH IKONA

• SPECIFIKACIJE



SPECIFIKACIJE APLIKACIJE •

- drvo •
- keramika •
- plastični •
- aluminijum • **ALU**
- bakar • **Cu**
- kamen •
- staklo •
- zid •
- papir •
- čelik •
- kompozit •
- pločice •
- nerđajući čelik • **INOX**
- malter •
- drvo sa vijcima, ekseri •
- gips karton • **DRYWALL**
- za tucanje materijala sa zateznom snagom do... • **900 MPa**

- S2** • functional parts made of high-alloy tool steels S2
- HSS** • functional parts made of high-speed steel
- Cr-Mo** • functional parts from chrome-molybdenum steel
- CrV** • functional parts from chrome-vanadium steel
- INOX** • functional parts from stainless steel
- NYLON** • najlonska drška
- TEFLON** • teflon surface
- Zn** • Zn sloj
- TiN** • TiN sloj
- HRC 58-61** • Tvrdća materijala (Rockwell)
- 40% PES** • napravljeno od 40% polyester
- PES** • napravljeno od polyester
- dijamantna zrna
- magnetno

- SDS+** **SDS MAX** **M14** • sistem stezanja
- broj zuba u ratchetu
- 1/2"** **3/4"** **1/4"** • montažna veličina
- informacije o zaštiti sluha
- DIN 3113** • standard
- 32x** • broj proizvoda u kompletu
- II. class** **III. class** • klasa tačnosti
- pogodno za hladno vreme
- ergonomska drška
- HOBBY** • hobi
- 2x AAA** • vrsta i broj potrebnih baterija
- UV STABLE** • uv stabilno
- RUBBER ENDS** • gumeni krajevi otporni na sudar

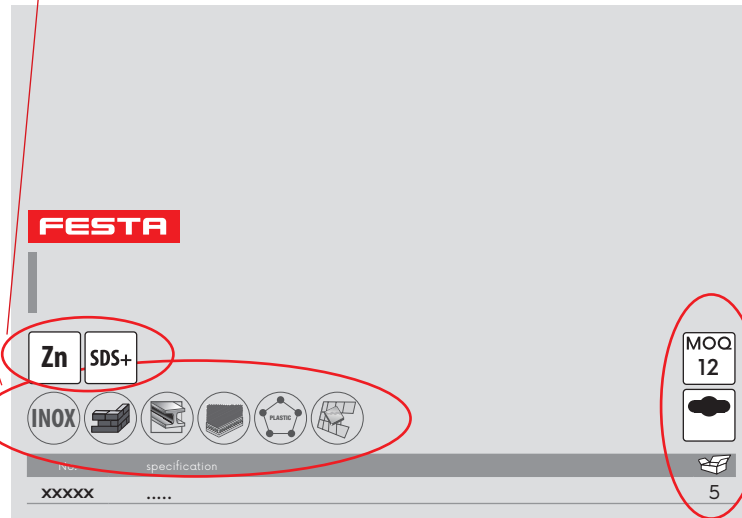

• AMBALAŽA I ZALIHE

- spakovano u kutiju
- euro slot
- MOQ 12** • minimalna količina porudžbine
- 5** • broj komada u pakovanju

AQUATIC FESTA A ROSA SPECIFIKACIJE •

- podeseive šare raspršivanja •

- minimalni i maksimalni pritisak • **2bar min** **4bar max**
- maksimalni protok vode • **Max** **27L/min**
- navodnjavana površina • **318 m²**
- veličina navoja adaptera • **1/2"**
- prečnik creva • **1/2"**

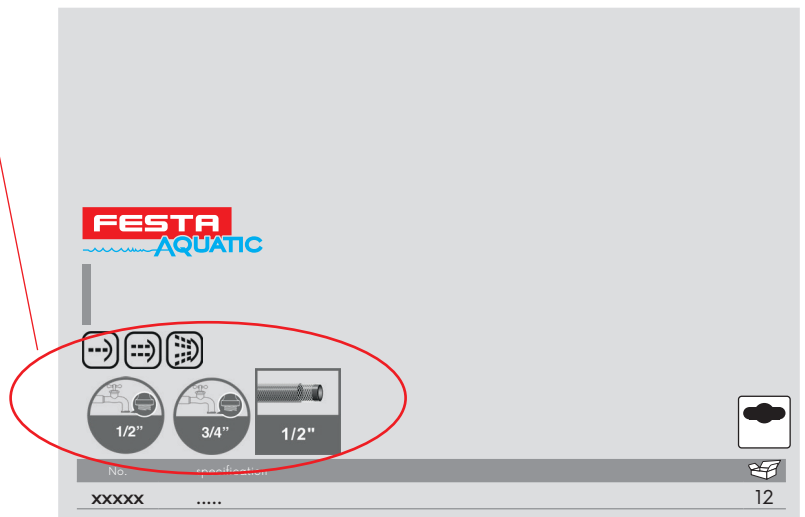

20

25

26

FESTA

ПРОФЕСИОНАЛНИ  АЛАТИ



festatools



#festatools



festatools



www.festa.tools

HORIZONT.

FESTA
POWER X TOOLS

FESTA
AQUATIC

ROSA KOMELON.

KDS

Stahlberg

SUPER PRO

Lescha

