



FESTA

PROFESIONALNI  ALATI



20
25
—
26

FESTA
POWER X TOOLS

Elektro i AKU alat kvalitetnih komponenti, najnovije tehnologije i u aktualnim trendovima u svom asortiman

FESTA

Brand profesionalnog ručnog alata za radionicu i vrt

FESTA
INDUSTRY

Vrhunska linija izabranih strojeva i ručnog alata, najviše kvalitete, dizajnirana za zahtjevne radne uvjete gdje je učinak prioritet

FESTA
AQUATIC

Profesionalni asortiman za zalijevanje modernog dizajna, kompatibilan s proizvodnom linijom Rosa

HORIZONT
MASTER

Brend vrhunskih vodo vaga

HORIZONT

Brend visokokvalitetnih vodo vaga i letva

ROSA

Kvalitetni sustavi navodnjavanja i vrtni alati

KDS[®]

Japanski noževi s dugom tradicijom

KOMELON[®]

Strucni mjeraci



Strucni rezac pločica



Proizvoac kvalitetnih škara za vrt

Lescha

Profesionalne miješalice za graevinu

Stahlberg

Profesionalni vijčani dodaci



Brend profesionalnih pila

AKUMULATORSKI I ELEKTRIČNI ALATI

2 - 53



ALATI ZA BUŠENJE I REZANJE

54 - 93



ALATI ZA RADIONICE

94 - 205



RADIONICA

206 - 241



GRAĐEVISKI ALATI

242 - 307



VRTNI ALATI

308 - 359



FESTA

360 - 365



POPIS STAVKI

366 - 380



BUŠILICA

4



UDARNA BUŠILICA

9



KLAMERICA
ZA SPAJALICE I CAVLICE

10



KUTNA BRUSILICA

11



VIBRACIONA BRUSILICA

12



KRUŽNA PILA

13



KOMPRESOR ZA ZRAK

15



VIBRACIJSKI
VAKUM ZA PLOČE

16



PIŠTOLJ ZA SILIKON

17



LED REFLEKTOR

17



RADIO DAB+ / FM / BT

18



UDARNA BUŠILICA

23



KRUŽNA PILA

26



KUTNA BRUSILICA

27



BRUSILICA ZA SUHOZID

36



USIVAČI

37



MIJEŠALICA
ZA PRAŠKASTI MATERIJAL

38



VISOKOTLAČNI ČISTAČI

39



REZAČI POLISTIRENA

40



INVERTER ZA ZAVARIVANJE

43



POLIFUZIJSKI ZAVARIVAČI

45



KOMPRESORI
I PRIBOR

46



TOPOVI NA VRUĆI ZRAK

50



GRIJALICE

52



PRODUŽNI KABLOVI

53



ELEKTRIČNI ALATI

2 - 53



FESTA
POWER X TOOLS

BRUSHLESS **SHARE** **Li-ion**
20V *technology*

brzina
0-550 min⁻¹
0-2000 min⁻¹

težina
sa baterijom 2,0 Ah **1,8 kg**
sa baterijom 4,0 Ah **2,1 kg**

okretni moment
80 Nm

prihvat
2 - 13 mm



The set contains:
- udarna bušilica
- 2.0 Ah baterija
- 4.0 Ah baterija
- 2.4 A punjač
- dodatna drška
- kofer



FESTA
POWER X TOOLS

ČEKIĆ BUŠILICA AKUMULATORSKA



Broj specifikacija
28000

2

BRUSHLESS SHARE 20V *Li-ion technology*

brzina
0-550 min⁻¹
0-2000 min⁻¹

težina
sa baterijom 2,0 Ah
1,8 kg
sa baterijom 4,0 Ah
2,1 kg

okretni moment
80 Nm

prihvati
2 - 13 mm

The set contains:
- udarna bušilica
- 2.0 Ah baterija
- 2.4 A punjač
- dodatna drška
- kofer



odabir načina rada izbor sile momenta

dodatna drška

prekidač brzine

stezna glava za brzo otpuštanje

prekidač smjera vrtnje

ergonomska gumirana ručka za udobno i sigurno držanje

LED svjetlo

kuka za vješanje

prekidač za otpuštanje baterije



ČEKIĆ BUŠILICA AKUMULATORSKA

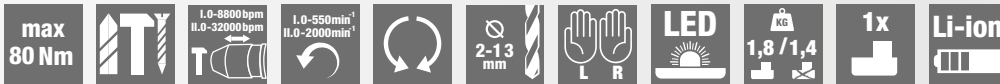

Broj specifikacija

28001

2

BRUSHLESS SHARE 20V

brzina
0-550 min⁻¹
0-2000 min⁻¹

težina
bez baterije
1,4 kg

okretni moment
80 Nm

prihvati
2 - 13 mm

odabir načina rada izbor sile momenta

dodatna drška

prekidač brzine

stezna glava za brzo otpuštanje

prekidač smjera vrtnje

ergonomska gumirana ručka za udobno i sigurno držanje

LED svjetlo

kuka za vješanje



ČEKIĆ BUŠILICA AKUMULATORSKA



*bez baterije

Broj specifikacija

28002

5

SHARE
20V

Li-ion
technology

brzina
0-500 min⁻¹
0-1800 min⁻¹

težina
sa baterijom 2,0 Ah
1,7 kg

okretni moment
45 Nm

prihvat
2 – 13 mm

The set contains:

- udarna bušilica
- 2x 2.0 Ah baterija
- 2.4 A punjač
- kofer
- držač bita i bitovi:
- ⊖ S5, S6 x 25 mm
- ⊕ PH1, PH2 x 25 mm
- ✦ PZ1, PZ2 x 25 mm
- HSS drills
- 2-2.5-3-4-5-6 mm



odabir načina rada izbor
sile momenta

stezna glava za
brzo otpuštanje

prekidač brzine

ergonomska gumirana
ručka za udobno i sigurno
držanje

prekidač smjera vrtnje

LED svjetlo

prekidač za
otpuštanje
baterije

kuka za vješanje



FESTA
POWER X TOOLS

ČEKIĆ BUŠILICA AKUMULATORSKA



Broj
28003

specifikacija

3

SHARE
20V

brzina
0-550 min⁻¹
0-2000 min⁻¹

težina
bez baterije
1,4 kg

okretni moment
45 Nm

prihvat
2 – 13 mm

odabir načina rada izbor
sile momenta

stezna glava
za brzo
otpuštanje

prekidač brzine

ergonomska gumirana
ručka za udobno i sigurno
držanje

prekidač smjera vrtnje

LED svjetlo

kuka za vješanje



SHARE
20V
Li-ion
technology



FESTA
POWER X TOOLS

ČEKIĆ BUŠILICA AKUMULATORSKA



*bez baterije

Broj
28004

specifikacija

5

SHARE
20V *Li-ion*
technology

brzina
0-350 min⁻¹
0-1300 min⁻¹

težina
sa baterijom 2,0 Ah
1,3 kg

okretni moment
28 Nm

prihvat
1 - 10 mm

- The set contains:
- udarna bušilica
 - 2x 2.0 Ah baterija
 - 2.4 A punjač
 - kofer
 - držač bita i bitovi:
 - ⊖ S5, S6 x 25 mm
 - ⊕ PH1, PH2 x 25 mm
 - ⊕ PZ1, PZ2 x 25 mm
 - HSS svrdla
 - 1,5-2,5-3-4-5-6 mm



BUŠILICA AKUMULATORSKI ODVIJAČ

max 28 Nm		L0-350min ⁻¹ H0-1300min ⁻¹		1-10 mm		LED	1,3 / 0,9	2x	Li-ion
--------------	--	---	--	---------	--	-----	-----------	----	--------



Broj specifikacija

28005

3

odabir načina rada izbor
sile momenta

stezna glava za
brzo otpuštanje

prekidač brzine

prekidač
smjera vrtnje

ergonomska gumirana
ručka za udobno i sigurno
držanje

LED svjetlo

kuka za vješanje

prekidač za
otpuštanje baterije



SHARE
20V

brzina
0-350 min⁻¹
0-1300 min⁻¹

težina
bez baterije
0,9 kg

okretni moment
28 Nm

prihvat
1 - 10 mm

odabir načina rada
izbor sile momenta

stezna glava za
brzo otpuštanje

prekidač brzine

prekidač
smjera vrtnje

ergonomska gumirana
ručka za udobno i sigurno
držanje

LED svjetlo

kuka za vješanje



SHARE
20V *Li-ion*
technology



BUŠILICA AKUMULATORSKI ODVIJAČ

max 28 Nm		L0-350min ⁻¹ H0-1300min ⁻¹		1-10 mm		LED	0,9
--------------	--	---	--	---------	--	-----	-----

*bez baterije

Broj specifikacija

28006



5

Li-ion
technology

brzina
0-350 min⁻¹
0-1300 min⁻¹

težina
sa baterijom 1,5 Ah
1 kg

okretni moment
20 Nm

prihvat
1 - 10 mm

- The set contains:
- udarna bušilica
 - 2x Baterija 12 V | 1.5 Ah
 - Punjač 12 V | 2.4 A
 - kofer
 - držač bita i bitovi:
 - ⊖ S5, S6 x 25 mm
 - ⊕ PH1, PH2 x 25 mm
 - ⊕ PZ1, PZ2 x 25 mm
 - HSS svrdla
1,5-2,5-3-4-5-6 mm



odabir načina rada
izbor sile momenta

stezna glava za
brzo otpuštanje

prekidač brzine

LED svjetlo

indikator
napunjenosti baterije

prekidač
smjera vrtnje

ergonomska gumirana
ručka za udobno i sigurno
držanje

baterija



FESTA
POWER X TOOLS

BUŠILICA AKUMULATORSKI ODVIJAČ

max 20 Nm

1.0-350min⁻¹
0.0-1300min⁻¹

1-10 mm

LED

1

2x

Li-ion



Broj specifikacija

28007

5

Li-ion
technology

brzina okretaja
bez opterećenja
200 min⁻¹

težina
sa baterijom 1,5 Ah
0,4 kg

maximum okretni
moment
3 Nm

prihvat alata
1/4" hexagon

- The set contains:
- odvijač
 - Punjač 5 V | 0,5 A
 - držač bita i bitovi:
 - ⊖ S5 x 50 mm
 - ⊕ PH1 x 50 mm
 - ⊕ PH2 x 50 mm
 - ⊕ H5 x 50 mm
 - ⊕ T20 x 50 mm

1/4 „stezna glava za
brzo otpuštanje sa osiguračem

smjer vrtnje

indikator napunjenosti baterije

prekidač za postavljanje
ručke u vodoravan položaj

LED svjetlo

prekidač
smjera vrtnje

ergonomska gumirana
ručka za udobno
i sigurno držanje



LED svjetlo

FESTA
POWER X TOOLS

AKUMULATORSKI ODVIJAČ

max 3 Nm

200min⁻¹

1/4"

LED

0,4

Li-ion

3,6 V

1,5 Ah



Broj specifikacija

28008

10

SHARE
20V

brzina okretaja
bez opterećenja
0-2000 min⁻¹

težina
bez baterije
1,2 kg

okretni moment
150 Nm

broj
udaraca
0-3000 bpm

1/4 „stezna glava za
brzo otpuštanje sa osiguračem



izbor smjera vrtnje

ergonomska gumirana
ručka za udobno
i sigurno držanje

LED svjetlo

kuka za vješanje

SHARE
20V
Li-ion
technology



FESTA
POWER X TOOLS

AKUMULATORSKI UDARNI ODVIJAČ

max 150 Nm	0-2000min ⁻¹	0-3000bpm	1/4"	↻	↻	LED	KG 1,2
----------------------	-------------------------	-----------	------	---	---	-----	-----------

*bez baterije

Broj specifikacija

28021



SHARE
20V

brzina okretaja
bez opterećenja
I.0-300 min⁻¹
II.0-1000 min⁻¹

težina
bez baterije
1,7 kg

broj udaraca
0-5000 bpm

prihvati
SDS+

šipka za dubinu

promjena načina rada
(sa ili bez udaraca)

SDS stezna
glava

prekidač brzine

prekidač
smjera vrtnje



SHARE
20V
Li-ion
technology



FESTA
POWER X TOOLS

AKUMULATORSKA UDARNA BUŠILICA

IT	I.0-300 min ⁻¹ II.0-1000 min ⁻¹	0-5000 bpm	1,2J	↻	SDS+	↻	KG 1,7
----	--	------------	------	---	------	---	-----------

*bez baterije

Broj specifikacija

28025



2

SHARE
20V

broj udaraca
60-100 min⁻¹

maksimalna duljina čavala / spjalica
30 mm
tvrdi materijal

maksimalna duljina čavala / spjalica
50 mm
meki materijal

težina bez baterije
2,7 kg



SHARE
20V
Li-ion
technology



Čavlići

- 23930** Čavlići 30 mm, 2000 pcs
- 23931** Čavlići 40 mm, 2000 pcs
- 23932** Čavlići 50 mm, 2000 pcs

Spjalice

- 23935** Spjalice 30 mm, 2000 pcs
- 23936** Spjalice 40 mm, 2000 pcs

Prikladne vrste čavlića i spjalica:

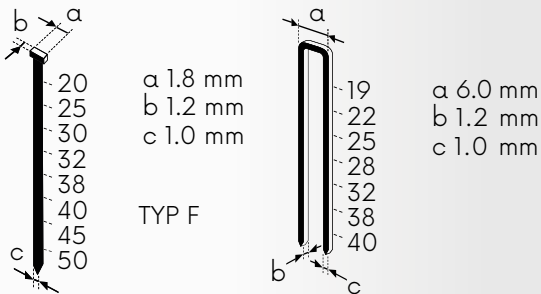

AKUMULATORSKA KLAMERICA ZA SPAJALICE I ČAVLIĆE

max 60 min⁻¹ | TYPE F | a 1.8 mm, b 1.2 mm, c 1.0 mm | a 6.0 mm, b 1.2 mm, c 1.0 mm | LED | 2,7 KG

*bez baterije

Broj specifikacija
28070



BRUSHLESS SHARE
20V

brzina okretaja bez opterećenja
8500 min⁻¹

težina bez baterije
1,6 kg

maksimalna debljina rezanog materijala
15 mm

maksimalni promjer diska/ploče
125 mm

otvor motora

ergonomska gumirana ručka za udobno i sigurno držanje

blokada rotacije

radni prekidač osigurača

zaštitni poklopac mehanizma za brzo otpuštanje

sigurnosna matica diska

SHARE
20V
Li-ion technology



FESTA
POWER X TOOLS

AKUMULATORSKA KUTNA BRUSILICA

8500 min ⁻¹	max Ø 125mm	M14	L R	KG 1,6
------------------------	-------------------	-----	-----	-----------

*bez baterije i diska

Broj specifikacija

28030



4

SHARE
20V

brzina okretaja bez opterećenja
8000 min⁻¹

težina bez baterije
1,6 kg

maksimalna debljina rezanog materijala
15 mm

maksimalni promjer diska/ploče
115 mm

ergonomska gumirana ručka za udobno i sigurno držanje

blokada rotacije

radni prekidač osigurača

zaštitni poklopac mehanizma za brzo otpuštanje

sigurnosna matica diska

SHARE
20V
Li-ion technology



FESTA
POWER X TOOLS

AKUMULATORSKA KUTNA BRUSILICA

8000 min ⁻¹	max Ø 115mm	M14	L R	KG 1,6
------------------------	-------------------	-----	-----	-----------

*bez baterije i diska

Broj specifikacija

28032



4

SHARE
20V

brzina okretaja
bez opterećenja
10000 min⁻¹

težina
bez baterije
1 kg

ekscentrični
disk
5 mm

promjer
diska
125 mm

radni prekidač osigurača



SHARE
20V
Li-ion
technology



FESTA
POWER X TOOLS

BATERIJSKA VIBRACIONA BRUSILICA



*bez baterije

Broj specifikacija

28040



4

SHARE
20V

brzina bez
opterećenja
5000-15000 min⁻¹

težina
bez baterije
1 kg

kontrola brzine



ručica za otpuštanje/
stavljanje pribora



SHARE
20V
Li-ion
technology



FESTA
POWER X TOOLS

VIŠENAMJENSKI BEŽIČNI UREĐAJ



*bez baterije

Broj specifikacija

28045



4

SHARE
20V



brzina okretaja bez opterećenja
3650 min⁻¹

podešavanje kuta nagib reza
45-90 stupnjeva

maks. promjer diska
165 mm
(ø16 mm)

maks. dubina reza
50 mm
* pod kutom od 90 stupnjeva ø165 mm



SHARE
20V
Li-ion
technology



FESTA
POWER X TOOLS

AKUMULATORSKA KRUŽNA PILA

- Set sadrži:
- kružna pila
 - bočna vodilica
 - ključ
 - list pile ø 165 x 2,8/2,0 x 20 mm 24T (**22314**)



Broj 28035 specifikacija



SHARE
20V

broj uboda pile
0-2400 min⁻¹

težina bez baterije
1,8 kg

maks. kut rezanja
45 stupnjeva

maks. promjer reznog profila
željezo: 6 mm
drvo: 80 mm

ergonomska gumirana ručka za udobno i sigurno držanje

radni prekidač osigurač

postavka predoscilacije

LED

zaključavanje mjerne letvice

vodilica

zaključavanje nagiba ploče

baza

nagib rezanja

0°
45° 45°

SHARE
20V
Li-ion
technology



FESTA
POWER X TOOLS

AKUMULATORSKA UBODNA PILA



*bez baterije

Broj specifikacija
28050



4

SHARE
20V

broj uboda pile bez opterećenja
0-3000 min⁻¹

težina bez baterije
1,7 kg

maks. debljina rezanja
drvo: 100 mm
željezo: 5 mm
aluminij/bakar: 20 mm

radni prekidač osigurač

ergonomska gumirana ručka za udobno i sigurno držanje

SHARE
20V
Li-ion
technology



FESTA
POWER X TOOLS

AKUMULATORSKA SABLJASTA PILA



*bez baterije

Broj specifikacija
28055

brzi prihvat lista pile



4

SHARE
20V

max. pritisak
8,2 bar

manometar
psi, bar,
kgf/cm², kPa

crijevo
600 mm

voltaža
baterije
20 V

zaslon manometra
s pozadinskim
osvjetljenjem



ergonomska
gumirana ručka
za udobno i sigurno
držanje

ventil crijeva za
napuhavanje

adapter za napajanje
iz akumulatora
automobila 3 m



adapteri

- Set sadrži:
- kompresor
 - adapter za napajanje iz akumulatora automobila
 - 3x adaptera za napuhavanje

crijevo
Ø 10,5 x 600 mm

LED svjetlo



Preporučeno

SHARE
20V
Li-ion
technology

- baterija*
- 2 Ah - 28080
 - 4 Ah - 28081
 - 8 Ah - 28083
- punjač*
- 2,4 A - 28085
 - 4,0 A - 28086



FESTA
POWER X TOOLS

KOMPRESOR ZA ZRAK

*baterija i punjač nisu uključeni

Broj	specifikacija
28075	
48013	NEW adapteri



1

1



NEW
 horizontalni položaj
 110 kg
 Ø 220 mm
 vertikalni položaj
 80 kg
 USB-C



FESTA
 POWER X TOOLS

VAKUUMSKA ČAŠICA AKU

Ø 220 mm	80 kg	110 kg	ROUGH SURFACE	USB-C	Li-ion 3.6V 2Ah
----------	-------	--------	---------------	-------	--------------------

Broj specifikacija

36326



1

SHARE
20V

Sposobnost usisavanja
 60 kg
 težina
 3 kg
 vibracije
 12 razina prilagodbe,
 3500 - 8500 r/min
 voltaža baterije
 20 V

ergonomska gumirana ručka za udobno i sigurno držanje



osvijetljeni zaslon



poluga za zaključavanje



usisna čašica Ø 125 mm



Preporučeno

SHARE
20V
 Li-ion
 technology

- baterija* 2 Ah - 28080
- 4 Ah - 28081
- 8 Ah - 28083
- punjač* 2,4 A - 28085
- 4,0 A - 28086



Set sadrži:

- vibrator za pločice
- baterija 2,0 Ah (samo 36328)
- punjač (samo 36328)
- kofer

FESTA
 POWER X TOOLS

VAKUM VIBRATOR ZA PLOČICE

Broj	specifikacija	
36328	sa 2Ah baterijom i punjačem	1
36329	bez baterije i punjača	1



SHARE
20V

podesiva brzina
0-8,7 mm/s

težina
1,7 kg

okretni moment
6500 N

voltaža baterije
20 V



Preporučeno

SHARE
20V
Li-ion technology

baterija* 2 Ah - 28080
4 Ah - 28081
8 Ah - 28083

punjač* 2,4 A - 28085
4,0 A - 28086



PIŠTOLJ ZA BRTLJENJE AKU

*baterija i punjač nisu uključeni

Broj	specifikacija
28060	



REZERVNI ULOŽAK ZA BRTLJENJE

za 28060

Broj	specifikacija
28061	600 ml



SHARE
20V

toplina svjetla
5000 K

težina bez baterije
0,9 kg

intezitet svjetla
2000 lm (100%)

LED jačina
20W



SHARE
20V
Li-ion technology



odabir inteziteta svjetla
50%, 100%



LED REFLEKTOR AKU

20W	2000 lumen	IP20	0,9 kg
-----	------------	------	--------

*baterija i punjač nisu uključeni

Broj	specifikacija
28065	



SHARE 20V

tuner
DAB+ / FM / BT

napon
2x 15 W

vodootpornost
IP54

voltaža
baterije
20 V

FM antenna



USB za punjenje 5V



SHARE
napajanje 20V



bojni zaslon

Preporučeno

SHARE
20V
Li-ion
technology

baterija*

2 Ah - 28080

4 Ah - 28081

8 Ah - 28083



punjač*

2,4 A - 28085

4,0 A - 28086



AUX IN jack 3,5 mm

stereo zvučnici



napajanje - adapter za 230 V



FESTA
POWER X TOOLS

RADIO DAB+ / FM / BT

- stereo
- DAB+ / FM
- vanjski ulaz Bluetooth V5.0 / AUX IN 3,5 mm jack
- otpornost na prodor vode IP54
- 30 memoriranih postavki (30 za DAB / 30 za FM)
- USB za punjenje
- 2,4" zaslon u boji
- snaga 2x 15 W
- 20 V / 1,3 A
- adapter za napajanje

*baterija i punjač nisu uključeni

Broj specifikacija
28076



SHARE
20V



PUNJAČ 20 V I 2,4 A

Broj: 28085 specifikacija: 220 – 240 V, 50 – 60 Hz, 70 W



SHARE
20V



PUNJAČ 20 V I 4,0 A

Broj: 28086 specifikacija: *220 – 240 V, 50 – 60 Hz, 105 W



SHARE *Li-ion technology*
20V



indikator napunjenosti baterije

BATERIJA 20 V I 2,0 Ah

20V	2,0 Ah	Li-ion	0,4
-----	--------	--------	-----



Broj: 28080 specifikacija:



SHARE *Li-ion technology*
20V



indikator napunjenosti baterije

BATERIJA 20 V I 4,0 Ah

20V	4,0 Ah	Li-ion	0,7
-----	--------	--------	-----



Broj: 28081 specifikacija:



SHARE *Li-ion technology*
20V



indikator napunjenosti baterije

BATERIJA 20 V I 8,0 Ah

20V	8,0 Ah	Li-ion	1,0
-----	--------	--------	-----



Broj: 28083 specifikacija:



SHARE
20V *Li-ion*
technology

28080



28085



DOBRA
CIJENA

FESTA
POWER X TOOLS

AKUMULATORSKI SET SA TORBOM 2+3

28080 - Baterija za akumulatorske alate FESTA SHARE20V 2,0 Ah
28085 - Punjač FESTA SHARE20V 2,4 A

Broj specifikacija
28090

1

SHARE
20V *Li-ion*
technology

28004
stranica 6

28025
stranica 9



37330



28030
stranica 12



BRUSHLESS

DOBRA
CIJENA
+TORBA GRATIS

FESTA
POWER X TOOLS

AKUMULATORSKI SET SA TORBOM 3+3

28004 - Bušilica akumulatorska sa čekićem FESTA SHARE20V
28025 - Akumulatorska udarna bušilica FESTA SDS+ SHARE20V
28030 - Kutna brusilica Aku FESTA "BRUSHLESS" SHARE20V 125 mm
28080 - Baterija za akumulatorske alate FESTA SHARE20V 2,0 Ah
28081 - Baterija za akumulatorske alate FESTA SHARE20V 4,0 Ah
28086 - Punjač FESTA SHARE20V 4,0 A

28080
stranica 18



28081
stranica 18



28086
stranica 18



Broj specifikacija
28102

1

BRUSHLESS **SHARE**
20V *Li-ion*
technology

28002
stranica 5



37330



28030
stranica 12



DOBRA
CIJENA
+TORBA GRATIS

FESTA
POWER X TOOLS

AKUMULATORSKI SET SA TORBOM 2+3

28002 - Bušilica akumulatorska sa čekićem FESTA SHARE20V
28030 - Kutna brusilica Aku FESTA "BRUSHLESS" SHARE20V 125 mm
28080 - Baterija za akumulatorske alate FESTA SHARE20V 2,0 Ah
28081 - Baterija za akumulatorske alate FESTA SHARE20V 4,0 Ah
28086 - Punjač FESTA SHARE20V 4,0 A

28080
stranica 18



28081
stranica 18



28086
stranica 18



Broj specifikacija
28103

1

**SHARE
20V**

**Li-ion
technology**

28004
stranica 6

28032
stranica 12

28055
stranica 15

**DOBRA
CIJENA
+TORBA GRATIS**

28035
stranica 14

37330

28040
stranica 13

**FESTA
POWER X TOOLS**

AKUMULATORSKI SET SA TORBOM 5+3

- 28004 - Bušilica akumulatorska sa čekićem FESTA SHARE20V
- 28032 - Kutna brusilica akumulatorska FESTA SHARE20V 115 mm
- 28035 - Kružna pila akumulatorska FESTA SHARE20V 165 mm/d 16 mm
- 28040 - Ekscentrična brusilica Aku FESTA SHARE20V 125 mm 8 otv.
- 28055 - Akumulatorska sabljasta pila FESTA SHARE20V
- 28080 - Baterija za akumulatorske alate FESTA SHARE20V 2,0 Ah
- 28081 - Baterija za akumulatorske alate FESTA SHARE20V 4,0 Ah
- 28086 - Punjač FESTA SHARE20V 4,0 A



28080
stranica 18



28081
stranica 18



28086
stranica 18



Broj specifikacija

28101



1

**SHARE
20V**

**Li-ion
technology**

28002
stranica 5

BRUSHLESS

28030
stranica 12

**DOBRA
CIJENA
+TORBA GRATIS**

28040
stranica 13

BRUSHLESS

28055
stranica 15

37330

28035
stranica 14

**FESTA
POWER X TOOLS**

AKUMULATORSKI SET SA TORBOM 5+3

- 28002 - Bušilica akumulatorska sa čekićem FESTA SHARE20V
- 28030 - Kutna brusilica Aku FESTA "BRUSHLESS" SHARE20V 125 mm
- 28035 - Kružna pila akumulatorska FESTA SHARE20V 165 mm/d 16 mm
- 28040 - Ekscentrična brusilica Aku FESTA SHARE20V 125 mm 8 otv.
- 28055 - Akumulatorska sabljasta pila FESTA SHARE20V
- 28080 - Baterija za akumulatorske alate FESTA SHARE20V 2,0 Ah
- 28081 - Baterija za akumulatorske alate FESTA SHARE20V 4,0 Ah
- 28086 - Punjač FESTA SHARE20V 4,0 A

28080
stranica 18



28081
stranica 18



28086
stranica 18



Broj specifikacija

28104



1

BRUSHLESS

alat pokreće DC motor bez četkica	
okretni moment	
brzina	
izbor smjera rotacije	
promjer svrdla/alata	
bušenje, bušenje sa udarcima, odvijanje	
broj udaraca u minuti	
bušenje, odvijanje	
težina sa/ bez baterije	
vrsta prihvata	
vrsta prihvata	
vrsta prihvata	
ekscentrični disk	
upravljanje uređajem za desnu i lijevu ruku	
zadovoljava taj standard	
intenzitet svjetla	
kut svjetlosti	
maksimalni broj udaraca	

**SHARE
20V**

alat je kompatibilan sa obje baterije

	preporučeni tip čavlića
	preporučeni tip spajalica
	brusni disk sa rupama
	maksimalni promjer diska
	promjer diska
	maksimalna debljina rezanja: drvo
	maksimalna debljina rezanja: željezo
	odabir oscilacije
	prihvat lista pile
	broj uboda pile
	možućnost kosog rezanja
	brzi prihvat lista pile
	broj oscilacije pile
	LED svjetlo
	kapacitet baterije
	baterija
	vrijeme punjenja

NEW

brzina okretanja
520 min⁻¹

BPM / udarna snaga
0 - 4100 / 12 J

snaga
1500 W

stezna
glava
SDS MAX



MAX ø beton - ø 40 mm



dubinomjer

sustav za smanjenje
vibracija

ergonomska
gumirana ručka
za udobno i sigurno
držanje



nalik na prašinu

SDS MAX
stezna glava



bočna ručka



FESTA
POWER X TOOLS

**UDARNA BUŠILICA
SDS MAX**

Set sadrži:

- udarna bušilica
- bočna ručka
- dubinomjer
- nalik na prašinu
- ključ
- kofer
- rezervne ugljene četkice
- pribor SDS MAX:

ø 16 x 280 mm
| 18 x 320 mm

rezervne ugljene
četkice 2 kom

- 28229



230V ~ 50Hz	1500W	4100 bpm	520min ⁻¹	12J	SDS MAX	3m RUBBER	6.8 kg	MAX ø40mm Concrete	
----------------	-------	-------------	----------------------	-----	------------	--------------	-----------	-----------------------	--

Broj specifikacija
28221

FESTA
POWER X TOOLS



brzina okretanja
0-850 min⁻¹

BPM / udarna snaga
0-4500 / 6 J

snaga
1500 W

stezna
glava
SDS+



MAX ø
beton - ø 32 mm
metal - ø 13 mm
drvo - ø 40 mm



dubinomjer

sustav za smanjenje
vibracija

SDS+
stezna glava

ergonomska
gumirana ručka
za udobno i sigurno
držanje

bočna ručka



FESTA
POWER X TOOLS

UDARNA BUŠILICA

Set sadrži:

- udarna bušilica
- bočna ručka
- dubinomjer
- ključ
- kofer
- rezervne ugljene četkice
- pribor SDS+:

⚡ ø 8, 10, 12 x 160 mm

🔧 20 x 250 mm

📏 14 x 250 mm



rezervne ugljene
četkice 2 kom - 28228



Broj specifikacija
28225



brzina okretanja
0-1350 min⁻¹

BPM / udarna snaga
0-5500 / 2,8 J

snaga
800 W

stezna
glava
SDS+
ø 2 - 13 mm



MAX ø beton - ø 25 mm
metal - ø 13 mm
drvo - ø 30 mm



FESTA
POWER X TOOLS

UDARNA BUŠILICA

- Set sadrži:
- udarna bušilica
 - bočna ručka
 - dubinomjer
 - stezna glava ø 2 - 13 mm
 - kofer
 - vazelin
 - rezervne ugljene četkice
 - pribor SDS+:
 - ø 6, 8, 10 x 160 mm
 - 20 x 250 mm
 - 14 x 250 mm



rezervne ugljene četkice 2 kom - 28223



28220
Broj specifikacija



brzina okretanja
0-4500 min⁻¹

težina
4,3 kg

snaga
1400 W

maks. promjer
diska / osovina
max ø 185 mm / ø 20 mm



ergonomska gumirana ručka za udobno i sigurno držanje



longitudinal cut stop (side guide)
6 - 120 mm



KRUŽNA PILA

- Set sadrži:
- kružna pila
 - bočna vodilica
 - ključ
 - rezervne ugljene četkice
 - list pile ø 185 x 2,3/1,3 x 20 mm 24T (22316)



1400W	230V ~ 50Hz	4500 min⁻¹	ø 20 1 mm	90°	45°	42mm	KG 4.3
			MAX 185mm	63mm			

rezervne ugljene četkice 2 kom - 28233



brzina okretanja
6600 min⁻¹

težina
5,8 kg

snaga
2400 W

maksimalni
promjer diska/
ploče

M14
max ø 230 mm

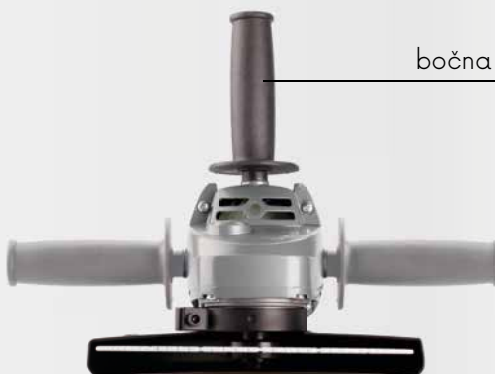

bočna ručka



ergonomska
gumirana ručka
za udobno i sigurno
držanje

SOFT START

glatko pokretanje motora



radni prekidač osigurača

3,0m

zaštitni poklopac



rotirajuća ručka



FESTA
POWER X TOOLS

KUTNA BRUSILICA

Set sadrži:

- kutna brusilica
- zaštitni štitnik
- bočna ručka
- ključ
- rezervne ugljene četkice

2400W 230V ~ 50Hz 6600min⁻¹ M14 max ø 230mm 2.0m RUBBER 5.8



rezervne ugljene
četkice 2 kom

- 28218



Broj specifikacija

28215

2

brzina okretanja
11000 min⁻¹

težina
2 kg

snaga
900 W

maksimalni promjer diska/
ploče
M14
max ø 125 mm

bočna ručka



SOFT START

glatko pokretanje motora

radni prekidač osigurača



zaštitni poklopac

3,0m

FESTA
POWER X TOOLS

KUTNA BRUSILICA

Set sadrži:

- kutna brusilica
- zaštitni štitnik
- bočna ručka
- ključ
- rezervne ugljene četkice



900W	230V ~ 50Hz	11000min⁻¹	M14	max ø 125mm	2.0m RUBBER	KG 2.0		rezervne ugljene četkice 2 kom - 28213	
-------------	-----------------------	------------------------------	------------	--------------------	--------------------	---------------	--	---	--

Broj 28210
specifikacija

8

FESTA
POWER X TOOLS

REZERVNE UGLJENE ČETKICE

2x



Broj	specifikacija	
28229	za 28221 - udarna bušilica	1
28228	za 28225 - udarna bušilica	1
28223	za 28220 - udarna bušilica	1
28233	za 28230 - kružna pila	1
28213	za 28210 - kutnu brusilicu	1
28218	za 28215 - kutnu brusilicu	1



ADAPTER SDS MAX / SDS+

SDS MAX → SDS+		
Broj	specifikacija	
20744		1



ADAPTER SDS+ / 1/2" UNF

SDS+		
Broj	specifikacija	
20745		1



FESTA

ADAPTER SDS+ ZA BIT 1/4"

SDS+ → 1/4"		
Broj	Specifikacija	
20743	75 mm	20



FESTA

STEZNA GLAVA

1/2"		
Broj	specifikacija	
20960	1-13 mm + 2 ključ, 1/2 - 20 UNF	3
20966	rezervni ključ	25



FESTA

SAMOSTEZNA GLAVA

1/2"		
Broj	specifikacija	
20965	1,5 - 13 mm 1/2' - 20 UNF	1



SAMOSTEZNA GLAVA

1/2"		
Broj	specifikacija	
20961	1,5 - 13 mm 1/2' - 20 UNF	1



ADAPTER ZA VRTANJE 90°

Broj	specifikacija	
20365	Ø 1 - 10 mm	10



BRZI STEZAČ ZA AKU BUŠILICU

1/4"		
Broj	specifikacija	
20963	Ø 1 - 6 mm	10



FESTA

USISIVAČ PRAŠINE

Broj	specifikacija	
28267	max. 70 mm	1

ŠABLONA ZA BUŠENJE

Broj	specifikacija	
20379	Ø 4, 5, 6, 7, 8, 10, 12 mm	10

TEHNIČKE
KARAKTERISTIKE

KATALOŠKI BROJ ARTIKLA	28000	28001	28002	28003	28004
Naziv	Bežična udarna bušilica	Bežična udarna bušilica	Bežična udarna bušilica	Bežična udarna bušilica	Bežična udarna bušilica
Brzina bez opterećenja	I.0-550 min ⁻¹ II.0-2000 min ⁻¹	I.0-550 min ⁻¹ II.0-2000 min ⁻¹	I.0-550 min ⁻¹ II.0-2000 min ⁻¹	I.0-500 min ⁻¹ II.0-1800 min ⁻¹	I.0-500 min ⁻¹ II.0-1800 min ⁻¹
Broj okretaja	I.0-8800min ⁻¹ II.0-32000min ⁻¹	I.0-8800min ⁻¹ II.0-32000min ⁻¹	I.0-8800min ⁻¹ II.0-32000min ⁻¹	0-19200 min ⁻¹	0-19200 min ⁻¹
Broj udaraca					
Okretni moment	80 Nm	80 Nm	80 Nm	45 Nm	45 Nm
Maks. voltaža baterije	20V	20V	20V	20V	20V
Broj stupnjeva zakretnog momenta	20+1+1	20+1+1	20+1+1	19+1+1	19+1+1
Stezna glava	2-13 mm	2-13 mm	2-13 mm	2-13 mm	2-13 mm
Težina bez baterije	1,4kg	1,4kg	1,4kg	1,3kg	1,3kg
Zaštita	IPX0	IPX0	IPX0	IPX0	IPX0
Razina tlaka buke K	LpA=97,04dB(A) K=5dB(A)	LpA=97,04dB(A) K=5dB(A)	LpA=97,04dB(A) K=5dB(A)	LpA=79dB(A) K=5dB(A)	LpA=79dB(A) K=5dB(A)
Razina snage buke K	LwA=86,04dB(A) K=5dB(A)	LwA=86,04dB(A) K=5dB(A)	LwA=86,04dB(A) K=5dB(A)	LwA=90dB(A) K=5dB(A)	LwA=90dB(A) K=5dB(A)
Vibracija kod bušenja bez udaraca u metal	$a_{h,d}=3,9m/s^2$ K=1,5m/s ²	$a_{h,d}=3,9m/s^2$ K=1,5m/s ²	$a_{h,d}=3,9m/s^2$ K=1,5m/s ²	$a_{h,d}=2,4m/s^2$ K=1,5m/s ²	$a_{h,d}=2,4m/s^2$ K=1,5m/s ²
Vibracija kod bušenja bez udaraca u beton	$a_{h,d}=11,4m/s^2$ K=1,5m/s ²	$a_{h,d}=11,4m/s^2$ K=1,5m/s ²	$a_{h,d}=11,4m/s^2$ K=1,5m/s ²	$a_{h,d}=7,5m/s^2$ K=1,5m/s ²	$a_{h,d}=7,5m/s^2$ K=1,5m/s ²
Maksimalna vibracija K					
Udarna snaga					
Promjer bušenja					
Vibracija kod bušenja u beton					
Vibracija kod bušenja u beton sa dodatnom ručkom					
Sadržaj paketa	bušilica, punjač 2.4A, 2.0 Ah baterija,4.0 Ah baterija,dodatna ručka,kofer	bušilica, punjač 2.4 A , 2.0 Ah baterija, dodatna ručka, kofer	bušilica	bušilica, 2.4 A punjač, 2x2,0 Ah baterija, 6x bit, držač bita, 6x svrdlo	bušilica



28005	28006	28007	28008	28021	28025
Bušilica akumulatorski odvijač	Bušilica akumulatorski odvijač	Bušilica akumulatorski odvijač	Aku odvijač	Akumulatorski udarni ključ	Aku bušilica čekić
I.0-350 min ⁻¹ II.0-1300 min ⁻¹	I.0-350 min ⁻¹ II.0-1300 min ⁻¹	I.0-350 min ⁻¹ II.0-1300 min ⁻¹	200 min ⁻¹	0-2000 min ⁻¹	I.0-300 min ⁻¹ II.0-1000 min ⁻¹
					0-5000bpm
				0-3000bpm	
28 Nm	28 Nm	20 Nm	3 Nm	150 Nm	
20V	20V	12V	3.6V	20V	20V
19+1	19+1	19+1	6+1		
1-10mm	1-10mm	1-10mm	1/4" hexagon	1/4" hexagon	SDS+
0,9kg	0,9kg	*1kg	*0,4kg	1,2kg	1,7kg
IPX0	IPX0	IPX0	IPX0	IPX0	IPX0
LpA=69dB(A) K=5dB(A)	LpA=69dB(A) K=5dB(A)	LpA=78dB(A) K=5dB(A)	LpA=58dB(A) K=3dB(A)	LpA=92dB(A) K=3dB(A)	LpA=82,98dB(A) K=3dB(A)
LwA=80dB(A) K=5dB(A)	LwA=80dB(A) K=5dB(A)	LwA=67dB(A) K=5dB(A)	LwA=69dB(A) K=3dB(A)	LwA=103dB(A) K=3dB(A)	LwA=93,98dB(A) K=3dB(A)
$\alpha_{h,D} < 1,9m/s^2$ K=1,5m/s ²	$\alpha_{h,D} < 1,9m/s^2$ K=1,5m/s ²	$\alpha_{h,D} = 2,1m/s^2$ K=1,5m/s ²			
$\alpha_{h,D} = 10,1m/s^2$ K=1,5m/s ²	$\alpha_{h,D} = 10,1m/s^2$ K=1,5m/s ²	$\alpha_{h,D} = 7,5m/s^2$ K=1,5m/s ²			
			$\alpha_h < 2,5m/s^2$ K=1,5m/s ²	$\alpha_{h,D} = 15,9m/s^2$ K=1,5m/s ²	
					1,2J
					metal: 10mm beton: 20mm drvo: 20mm
					$\alpha_{h,(HD)} = 5,582m/s^2$ K=1,5m/s ²
					$\alpha_{h,(HD)} = 5,523m/s^2$ K=1,5m/s ²
bušilica, 2.4 A punjač, 2x2,0 Ah baterija, 6x bit, držač bita, 6x svrdlo	bušilica	bušilica, 2.4 A punjač, 2x1,5 Ah baterija, 6x bit, držač bita, 6x svrdlo	odvijač, 0,5 A punjač, 1,5 Ah baterija, 5x bit	udarni odvijač	udarna bušilica, dodatna ručka, šipka za dubinu

* težina je navedena uključujući bateriju

TEHNIČKE
KARAKTERISTIKE

KATALOŠKI BROJ ARTIKLA	28030	28032	28035	28040
Naziv artikla	Bežični kut brusilica	Bežični kut brusilica	Bežični kružni pila	Baterijska orbitala brusilica
Okretaji bez opterećenja	8500 min ⁻¹	8000 min ⁻¹	3650 min ⁻¹	10000 min ⁻¹
Broj oscilacija bez opterećenja				
Nagib prema naprijed				
Određivanje kuta rezanja				
Broj „udaraca“ pile				
Maksimalni promjer rezanja				
Maksimalni promjer diska	125 mm	115 mm		
Držac brusnog papira				125 mm
8 usisnih rupa na disku				65 mm
Ekscentričnost diska				5 mm
Dimenzija sigurnosne matice	M14	M14		
Maksimalni promjer reznog materijala	15 mm	15 mm		
Maks. voltaža baterije	20V	20V	20V	20V
Podešavajući kut rezanja			0-45°	
Rezanje po kutom od 45 °			35 mm	
Rezanje po kutom od 90 °			50 mm	
Kut oscilacije				
Dimenzija brusne baze				
Kontrola vibracije				
Prihvati pile				
Udarci pile				
Dimenzija baze			28 cm x 13,3 cm	
Težina bez baterije	1,6kg	1,6kg	2,7kg	1kg
Promjer diska			165 mm	
Debljina diska			1,4 mm ± 5% mm	
Debljina zuba			2,0 ± 5% mm	
Širina rezanja			2,3 ± 5% mm	
Promjer rupe kotača nakon stezanja			16 mm	
Broj zuba na disku			24	
Štitnik	IPX0	IPX0	IPX0	IPX0
Tip čavlića, visina x širina x debljina				
Tip spajalica, visina x širina x debljina				
Maks. duljina čavlića / spojnice u mekše materijale				
Maks. duljina čavlića / spojnice u tvrde materijale				
Prosječno/maks. broj udaraca				
Operativno vrijeme (4 Ah baterija, puna)				
Kapacitet spremnika čavlića/spajalica				
Razina tlaka buke K	LpA=87,1dB(A) K=3dB(A)	LpA=76,67dB(A) K=3dB(A)	LpA=84dB(A) K=3dB(A)	LpA=76dB(A) K=3dB(A)
Razina snage buke K	LwA=98,1dB(A) K=3dB(A)	LwA=87,67dB(A) K=3dB(A)	LwA=95dB(A) K=3dB(A)	LwA=87dB(A) K=3dB(A)
Vibracija prilikom brušenja	$a_{h,AG}=8,363m/s^2$ K=1,5m/s ²	$a_{h,AG}=5,324m/s^2$ K=1,5m/s ²		
Vibracija prilikom rezanja				
Vibracija prilikom rezanja metala				
Vibracija prilikom rezanja drva				
Maksimalna vibracija			$a_h < 2,5m/s^2$ K=1,5m/s ²	$a_h = 9,5m/s^2$ K=1,5m/s ²
Sadržaj paketa	brusilica, štitnik od diska, dodatna ručka, ključ	brusilica, štitnik od diska, dodatna ručka, ključ	pila, šipka dubinomjera, rezni disk	brusilica, vreća za prašinu



28045	28050	28055	28070
Bežični uređaj višenamjenski	Akumulatorska ubodna pila	Akumulatorska sabljasta pila	Akumulatorska klameraica za čavliće i spajalice
5000-15000 min ⁻¹		0-3000 min ⁻¹	
		1°	
	3+0		
	0-2400 min ⁻¹		
	metal: 6mm, drvo: 80mm	drvo: 100 mm, čelik: 5 mm, aluminij/bakar: 20 mm	
20V		20V	20V
	kosi rez max. 45 °		
3°			
90 mm			
Da			
univerzalno		univerzalno	
		20 mm	
1kg	1,8kg	1,7kg	2,7kg
IPX0	IPX0	IPX0	IPX0
			F, 20-50mm x 1,2mm x 1,0 mm
			6,0mm x 19-40mm x 1,2mm x 1,0mm
			50 mm
			30 mm
			60/100 min ⁻¹
			1 sat
			100 komada
LpA=78dB(A) K=3dB(A)	LpA=88,1dB(A) K=5dB(A)	LpA=87,33dB(A) K=5dB(A)	LpA=79,9dB(A) K=3dB(A)
LwA=89dB(A) K=3dB(A)	LwA=99,1dB(A) K=5dB(A)	LwA=98,33dB(A) K=5dB(A)	LwA=90,9dB(A) K=3dB(A)
	$\alpha_{h,B}=3,3m/s^2$ $K=1,5m/s^2$	$\alpha_{h,B}=21,10m/s^2$ $K=1,5m/s^2$	
	$\alpha_{h,M}=4m/s^2$ $K=1,5m/s^2$		
		$\alpha_{h,WB}=21,98m/s^2$ $K=1,5m/s^2$	
$\alpha_h=2,8m/s^2$ $K=1,5m/s^2$			$\alpha_h=1,39m/s^2$ $K=1,5m/s^2$
brusilica, priključci (pila, strugač, nosač), 3x brusni papir P80	pila, vodilica, dodatak za usis, 2x list pile	pila, 2x list pile	klameraica, 200x čavlića, 200x spajalica

TEHNIČKE
KARAKTERISTIKE

KATALOŠKI BROJ ARTIKLA	28075	36328	36329	28060	28076
Name	Kompresor za zrak AKU	Vakum vibrator za pločice AKU	Vakum vibrator za pločice AKU	Pištolj za brtvljenje AKU	Radio AKU DAB+ / FM / BT
Manometar	psi; bar; kgf/cm ² ; kPa				
Max. pritisak	120 psi / 8,2 bar				
Crijevo	Ø 10,5 x 600 mm				
Usisna čašica		Ø 123 mm	Ø 123 mm		
Sposobnost usisavanja		60 kg	60 kg		
Vibracije		12 razina prilagodbe 3500 - 8500 r/min	12 razina prilagodbe 3500 - 8500 r/min		
Okretni moment				6500 N	
Podesiva brzina				0 - 8,7 mm/s	
Max. kapacitet				310 ml	
Tuner					DAB+ / FM
Vanjski ulaz					Bluetooth 5.0, aux IN jack 3,5 mm
Snaga					2 x 15 W
Zaslon					color 2,4"
Napajanje					adapter 230 V, baterija Li-ion FESTA share 20 V
Memoriranih postavki					30 (DAB+), 30 (FM)
Vodootpornost					IPX54
Težina		3 kg	3 kg	1,7 kg	1,3kg
Maks. voltaža baterije	20 V	20 V	20 V	20 V	20 V
Sadržaj paketa	Kompresor, adapter za napajanje iz akumulatora automobila, 3x adaptera za napuhavanje	Vakum vibrator za pločice, baterija 2,0 Ah, punjač, kofer	Vakum vibrator za pločice, kofer	Pištolj za brtvljenje	Radio, adapter 230 V



KATALOŠKI BROJ ARTIKLA	28221	28225	28220	28230	28210	28215
Naziv	Udarna bušilica SDS MAX	Udarna bušilica SDS+	Udarna bušilica	Kružni pila	Kutna brusilica	Kutna brusilica
Snaga	1 500 W	1 500 W	800 W	1 400 W	900 W	2 400 W
Brzina okretanja	0 - 520 min-1	0 - 850 min-1	0 - 1 350 min-1	0 - 4 500 min-1	0 - 11 000 min-1	0 - 6 600 min-1
BPM	0 - 4 100	0 - 4 500	0 - 5 500			
Udarna snaga	12 J	6 J	2,8 J			
Stezna glava	SDS MAX	SDS+	SDS+ chuck 2 - 13 mm	20 mm	M14 / 22,2 mm	M14 / 22,2 mm
Podešavanje kuta nagib reza				0 - 45°		
Maks. dubina reza 45°				42 mm		
Maks. dubina reza 90°				63 mm		
Maks. promjer diska				185 mm	125 mm	230 mm
Težina	6,8 kg	5 kg	3,2 kg	4,3 kg	2 kg	5,8 kg
Dužina kabla za napajanje i materijal	3 m guma	2 m guma	2 m guma	2 m plastični	2 m guma	2 m guma
Sadržaj paketa	udarna bušilica, bočna ručka, dubinomjer, ključ, kofer, rezervne ugljene četkice, pribor SDS MAX: <ul style="list-style-type: none"> ∅ 16 x 280 mm 18 x 320 mm 	udarna bušilica, bočna ručka, dubinomjer, ključ, kofer, rezervne ugljene četkice, pribor SDS+: <ul style="list-style-type: none"> ∅ 8, 10, 12 x 160 mm ∇ 20 x 250 mm 14 x 250 mm 	udarna bušilica, bočna ručka, dubinomjer, stezna glava ∅ 2 - 13, mm, kofer, vazelin rezervne ugljene četkice, pribor SDS+: <ul style="list-style-type: none"> ∅ 6, 8, 10 x 160 mm ∇ 20 x 250 mm 14 x 250 mm 	kružna pila, bočna vodilica, ključ, rezervne ugljene četkice, list pile ∅ 185 x 2,3/1,3 x 20 mm 24T (22316)	kutna brusilica, zaštitni štitičnik, bočna ručka, ključ, rezervne ugljene četkice	kutna brusilica, zaštitni štitičnik, bočna ručka, ključ, rezervne ugljene četkice

NEW

brzina okretanja
1000 - 1850 min⁻¹

duljina
110 - 180 cm

snaga
750 W

promjer diska
Ø 225 mm



ergonomska gumirana ručka za udobno i sigurno držanje



FESTA
POWER X TOOLS

BRUSILICA ZA SUHOZID

230V ~ 50Hz	750W	1000-1850min ⁻¹	Ø 225mm	110-180cm
LED	4m	DRYWALL		



Broj
28240

specifikacija

1

NEW



FESTA
POWER X TOOLS

USISIVAČ 30L

230 V ~50 Hz | 1600 W | MAX 2000W | 82dB | IPX4 | 3m | 5m

30L | WET DRY | AUTO ON-OFF | AUTOMATIC FILTER CLEANING | HEPA

Broj	specifikacija	
28345		1
28346	HEPA filter	1

NEW



WEST BERG

USISIVAČ 30L

230 V ~50 Hz | 1200 W | 3m | 5m | SEMI-AUTOMATIC FILTER CLEANING

30L | WET DRY | AUTO ON-OFF | HEPA

Broj	specifikacija	
28340		1
28342	HEPA filter	1

FESTA
 POWER X TOOLS

ELEKTRICNA MIJEŠALICA ZA PRAŠKASTI MATERIJAL

Ulazni	1800 W
Napon / frekvencija	230 V / 50 Hz
Zupčanici	2
1. brzina (brzina u praznom hodu)	0 - 450 ot./min.
2. brzina (brzina u praznom hodu)	0 - 790 ot./min.
Zaštita od preopterećenja	Da
Promjer miješalica	100 mm
Dužina miješalica	570 mm
Težina	5,6 kg



Broj	specifikacija	
35311	miješalica	1
35318	rezervne četkice	1
35319	rezervne mješalice - par (L+R)	1

FESTA
 POWER X TOOLS

ELEKTRIČNA MJEŠALICA 1600W

Ulazna snaga	1600 W
Napon/frekvence	230 V / 50 Hz
Stupanj brzina	2
1. stupanj (brzina bez opterećenja)	0 - 480 ot./min.
2. stupanj (brzina bez opterećenja)	0 - 800 ot./min.
Zaštita	Da
Navoj	M 14
Mješač	140 mm
Dužina mješalice	600 mm
Težina	4,7 kg

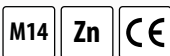

Broj	specifikacija	
35310		1
35317	rezervne četkice	1

FESTA
 POWER X TOOLS

ELEKTRIČNA MJEŠALICA 850W

Ulazna snaga	850 W
Napon/frekvence	230 V / 50 Hz
Stupanj brzina	1
1. stupanj (brzina bez opterećenja)	0 - 500 ot./min.
2. stupanj (brzina bez opterećenja)	-
Zaštita	Da
Navoj	M 14
Mješač	120 mm
Dužina mješalice	600 mm
Težina	3,7 kg



Broj	specifikacija	
35300		1
35316	rezervne četkice	1



NEW

**WEST
BERG**

ELEKTRIČNA MJEŠALICA 1600W

Ulazna snaga	1600 W
Napon/frekvence	230 V / 50 Hz
Stupanj brzina	2
1. stupanj (brzina bez opterećenja)	180 - 400 ot./min.
2. stupanj (brzina bez opterećenja)	300 - 700 ot./min.
Zaštita	Da
Navoj	M 14
Mješač	140 mm
Dužina mješalice	600 mm
Težina	5,4 kg

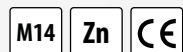

Broj	specifikacija	
35305		1
35315	rezervne četkice	1



NEW



FESTA
POWER X TOOLS

**VISOKOTLAČNI
ČISTAČ**

230 V ~50 Hz	1800 W	IPX5	MAX 7 l/min	MAX 140 bar	MAX 50°C	5m	AUTO STOP	7,8 kg
-----------------	-----------	------	-------------------	-------------------	-------------	----	--------------	-----------

Broj	Specifikacije
45271	



FESTA

**VISOKOTLAČNI
ČISTAČ**

230 V ~50 Hz	1500 W	MAX 120 bar	MAX 6 l/min	IPX5	5m	AUTO STOP
-----------------	-----------	-------------------	-------------------	------	----	--------------

Broj	specifikacija
45270	visokotlačni čistač



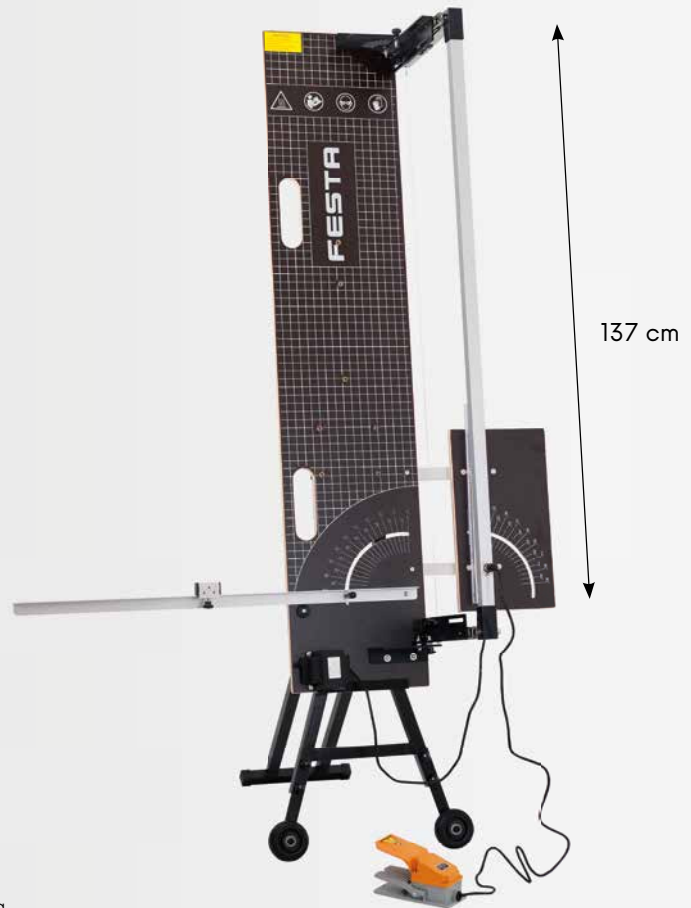
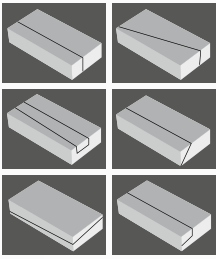

STROJ ZA REZANJE STIROPORA

- Napon / frekvencija: 230 V/50 Hz
- Potrošnja energije: 200 W
- Duljina reza: 137 cm
- Visina reza: 35 cm
- Zaštita: IP44
- Kut rezanja: 0° - 90°

· oprema: stalak, nožni prekidač, držač, Ni-Cr žica za rezanje, mesingana četka za čišćenje, alati, okovi, plastični luk s kotačićem



Broj Specifikacija

35348



1

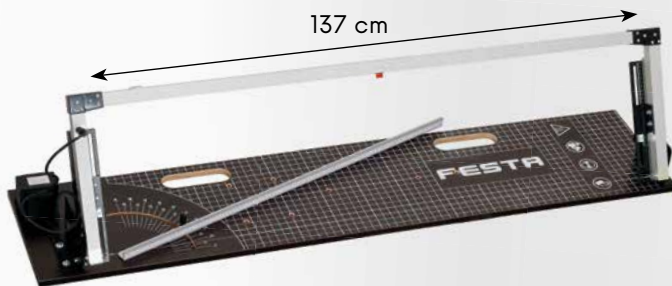
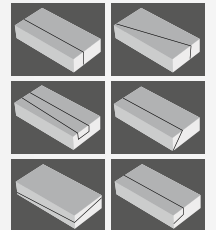
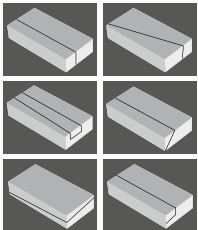

STROJ ZA REZANJE STIROPORA

- Napon / frekvencija: 230 V / 50 Hz
- Potrošnja energije: 200 W
- Duljina reza: 137 cm
- Visina reza: 35 cm
- Zaštita: IP44
- Kut rezanja: 0° - 90°

oprema: Ni-Cr rezna žica, mesing četka za čišćenje, imbus ključ



Broj specifikacija

35345



1



STROJ ZA REZANJE STIROPORA

- Napon / frekvencija: 230 V / 50 Hz
- Potrošnja energije: 160 W
- Duljina reza: 117 cm
- Visina reza: 35 cm
- Zaštita: IP44
- Kut rezanja: 0° - 90°

oprema: Ni-Cr rezna žica, mesing četka za čišćenje, imbus ključ



Broj specifikacija

35330



1



FESTA

STROJ ZA REZANJE STIROPORA

- Napon / frekvencija: 230 V / 50 Hz
- Potrošnja energije: 160 W
- Duljina reza: 117 cm
- Visina reza: 52 cm
- Zaštita: IP44
- Kut rezanja: 0° - 90°



oprema: Ni-Cr rezna žica, mesing četka za čišćenje, imbus ključ

Broj	specifikacija
35344	



FESTA

NOŽNI PŘEKIDAČ ZA REZAČ STIROPORA

- za 35330, 35345, 35348

Broj	Specifikacija
35334	



FESTA

STALAK ZA REZAČ STIROPORA

- za 35330, 35345, 35348

Broj	Specifikacija
35336	



FESTA

REZERVNA OPRUGA ZA REZAČ STIROPORA

- za 35330, 35345, 35348

Broj	Specifikacija
35332	



FESTA

REZERVNI STRUJNI ADAPTER ZA REZAČ STIROPORA

- za 35330, 35345, 35348



napon/frekvencija:	230 V / 50Hz
izlaz:	36 V / 5 A
Potrošnja energije:	200 W

Broj	Specifikacija
35347	



FESTA

DRŽAČ ZA REZAČ STIROPORA

- za 35330, 35345, 35348

Broj	Specifikacija
35333	



REZERVNI NIZ Cr-Ni ZA REZAČ STIROPORA

Broj	Specifikacija
35331	za rezač 117 cm
35346	za rezač 137 cm





Li-ion
technology

FESTA
POWER X TOOLS

BEŽIČNI STROJ ZA REZANJE STIROPORA

- baterija: 36 V, 1,5Ah Li-ion
- Potrošnja energije: 180 W
- Temperatura: max 350 C°
- Duljina noža: 20 cm
- oprema: 2 baterije, punjač, oštrica, mesing četka za čišćenje, imbus ključ



Broj	specifikacija	
35323	električni rezač stiropora	1
35328	rezervni nož za rezač stiropora 14 cm	1
35329	rezervni nož za rezač stiropora 25 cm	1

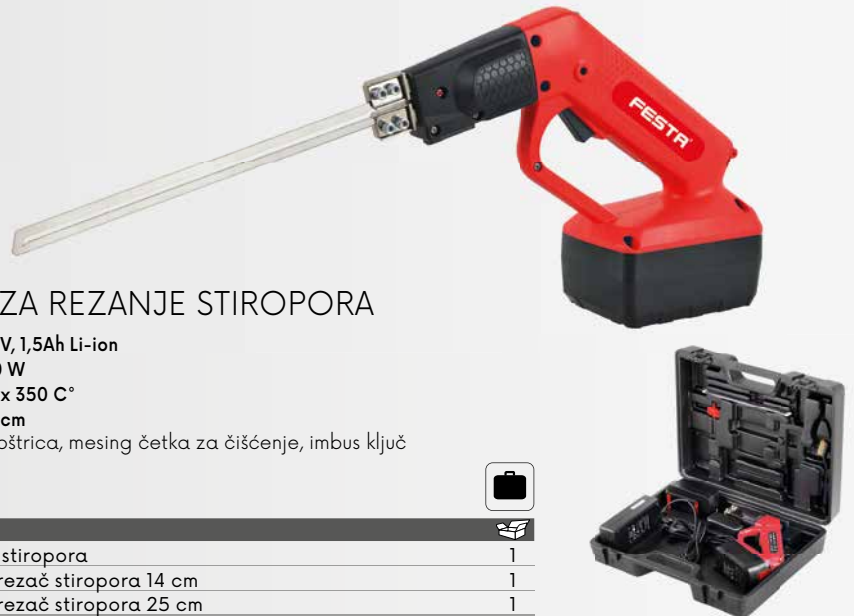

FESTA
POWER X TOOLS

STROJ ZA REZANJE STIROPORA

- Napon / frekvencija: 230 V/50 Hz
- Potrošnja energije: 250 W
- Temperatura: 50-600 C°
- Duljina noža: 25 cm
- Duljina dovodnog kabela: 3 m



- oprema: četka za čišćenje mesinga, imbus, nož 25 i 30 cm

Broj	specifikacija	
35326	električni rezač stiropora	1
35328	rezervni nož za rezač stiropora 14 cm	1
35329	rezervni nož za rezač stiropora 25 cm	1

VODILICA ZA REZANJE POLISTIRENA

- za 35323, 35326

Broj	specifikacija	
35327	vodilica za rezanje polistirena	1
35335	rezervni nož - dužina 30 cm	1



FESTA
POWER X TOOLS

STROJ ZA REZANJE STIROPORA



- regulacija temperature

Broj	specifikacija	
35325	220 W	1



**FESTA****INVERTERSKI APARAT ZA ZAVARIVANJE TIG/MMA**

Napon frekvencija :	230 V 50 Hz
Napon slobodan:	55 V
Regulatorni raspon struja za zavarivanje:	10 - 160 A
Promjer elektrode:	1,5 - 4,0 mm
Radni ciklus:	TIG- 160 A 60%, MMA - 140 A 60%
Klasa zaštite:	IP 21
Vrsta zavarivanja:	TIG/MMA
Dimenzije:	405 x 165 x 270 mm
Tehnologija:	Anti-stick, Arc-force, Hot start, Lift TIG
Težina:	6 kg



Broj specifikacija
70040 Inverterski aparat za zavarivanje TIG/MMA 160A



1

FESTA

LCD display

**FESTA****SAMOZATAMNJUJUĆA MASKA**

veličina vidnog polja	98 x 80 mm
brzina zamračenja filtra	1/25 000 s
zatamnjenje filtra	DIN 5-8 / 9-13
UV / IR zaštita	DIN 16
optička klasa	1 1 1 2
broj senzora	4
napajanje	solarna ćelija + baterija CR2450
način rada	Zavarivanje, brušenje

CE EN 379

Broj specifikacija
70064 aktivan 1
70066 zamjensko pokrovno staklo 1



1

**FESTA****SAMOZATAMNJUJUĆA MASKA**

Broj	specifikacija	
70063	aktivan	4

**SAMOZATAMNJUJUĆA MASKA**

Broj	specifikacija	
70060	aktivan	4

**VARILAČKA MASKA**

Broj	specifikacija	
70061		4

**REZERVNA STAKLA ZA VARILAČKU MASKU****2x**

Broj	specifikacija	
70065	113 x 80 mm	20

**VARILAČKE NAOČALE**

Broj	specifikacija	
70062		1

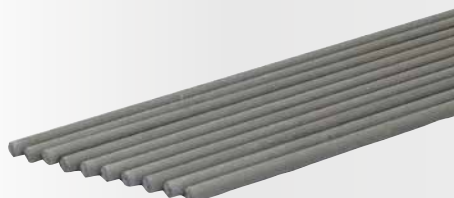
**ELEKTRODA RUTIL**

· kvalificiran

Broj	specifikacija	množství	
70021	Ø 2,0 x 300 mm	10 kom.	1
70020	Ø 2,0 x 300 mm	2,5 kg	8
70026	Ø 2,5 x 300 mm	10 kom.	1
70025	Ø 2,5 x 300 mm	2,5 kg	8
70033	Ø 3,2 x 350 mm	10 kom.	1
70032	Ø 3,2 x 350 mm	5 kg	4

**ELEKTRODA BASIC**

· kvalificiran

Broj	specifikacija	množství	
70030	Ø 2,0 x 300 mm	2,5 kg	1
70031	Ø 2,0 x 300 mm	5 kg	1
70035	Ø 2,5 x 300 mm	2,5 kg	8
70036	Ø 2,5 x 300 mm	10 kom.	1
70037	Ø 3,2 x 350 mm	5 kg	5

**VARILAČKI ČEKIĆ**

Broj	specifikacija	
19115	320 g	1

**STEGA VARILAČKA ZA ELEKTRODE**

Broj	specifikacija	
70070	300 A	1

**VARILAČKA KLIJEŠTA ZA MASU**

Broj	specifikacija	
70075	300 A	1



FESTA

KUTNI MAGNET



Broj	specifikacija	nosnost	
70096	150 x 130 x 30 mm · 45°, 90°, 135°	25 kg	10

KUTNI MAGNET



Broj	specifikacija	nosnost	
70090	85 x 85 mm · 45°, 90°	9 kg	10



KUTNI MAGNET



Broj	specifikacija	nosnost	
70093	95 x 64 mm · 30°, 45°, 60°, 75°, 90°	9 kg	10
70094	120 x 90 mm · 30°, 45°, 60°, 75°, 90°	18 kg	10
70095	137 x 110 mm · 30°, 45°, 60°, 75°, 90°	27 kg	10

KUTNI MAGNET



Broj	specifikacija	nosnost	
70091	95 x 109 x 25 mm · 45°, 90°, 135°	13 kg	10
70092	130 x 150 x 32 mm · 45°, 90°, 135°	22 kg	5



FESTA
POWER X TOOLS

ZAVARIVAČ CIJEVI

Napon / frekvencija:	230 V / 50 Hz
Potrošnja energije:	750 / 1500 W
Temperatura:	0-300 C°
Promjer:	Ø 20,25,32,40,50,63 mm
Težina:	1,6 kg



· oprema: mjerna traka, libela, odvijač, šesterokutni ključ, škare za cijevi, 4 x adapter za zavarivanje



Broj	17182		1
------	-------	--	---

FESTA
POWER X TOOLS

ZAVARIVAČ CIJEVI

Napon / frekvencija:	230 V / 50 Hz
Potrošnja energije:	800 / 1000 W
Temperatura:	0-300 C°
Promjer:	Ø 16, 20, 25, 32 mm
Težina:	1 kg



· oprema: šesterokutni ključ, 4 x adapter za zavarivanje



Broj	17183		1
------	-------	--	---

FESTA**KOMPRESOR 6L - BEZULJNI**

Napajanje:	230 V 50Hz
Potrošnja energije:	1,2 kW (1,5HP)
Volumen spremnika :	6 l
Maks. pritisak:	8 Bar
Okretaji:	3900 min.
Usisna snaga:	180 l/min.
Brzina punjenja:	116 l/min.
Težina:	10 kg



Broj
35360

**KOMPRESOR 24 L
BEZ ULJNI**

Izlazna snaga:	1100 W
Napajanje:	230 V 50Hz
Protok bez opterećenja:	2850 min-1
Radni tlak:	8 bar
Protok zraka:	160 l min
Tip:	bezolejový bez ulja
Kapacitet:	24 L
Težina:	23 kg



Broj specifikacija
35361 1,1 kW, 24 l

**KOMPRESOR 24 L**

Izlazna snaga:	1500 W
Napajanje:	230 V 50Hz
Protok bez opterećenja:	2850 min-1
Radni tlak:	8 bar
Protok zraka:	200 l min
Tip:	olejový oljavsav
Kapacitet:	24 L
Težina:	24 kg



Broj specifikacija
35362 1,5 kW, 24 l



500 ml



600 ml

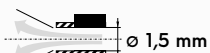

1000 ml

FESTA**PIŠTOLJ RASPRŠIVAČ
- GORNJI**

Broj specifikacija
48020 gornji

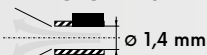
**FESTA****PIŠTOLJ RASPRŠIVAČ
- GORNJI**

Broj specifikacija
48021 gornji
48047 rezervne mlaznice Ø 1,7 mm

**FESTA****PIŠTOLJ RASPRŠIVAČ
- GORNJI**

Broj specifikacija
48022 gornji
48046 rezervne mlaznice Ø 1,5 mm



FESTA

ZRAČNI PIŠTOLJ



Ø 1,5 mm



Broj	specifikacija	
48030	donji	1



600 ml

PIŠTOLJ ZA PRSKANJE BOJA I ŽBUKA

- 4 - 6 Bar
- 5 l
- mlaznice Ø 4; 6; 8 mm



Broj	specifikacija	
48037		1

FESTA

ZRAČNI PIŠTOLJ

- 25 mm
- 90 mm
- 190 mm



Broj	specifikacija	
48004		10



25 mm

· 190 mm

· 90 mm

Ø 8,5 mm

FESTA

ZRAČNI PIŠTOLJ



Broj	specifikacija	
48005	kraći	25



FESTA

ZRAČNI PIŠTOLJ



Broj	specifikacija	
48006	srednji	25



50 mm

FESTA

ZRAČNI PIŠTOLJ



Broj	specifikacija	
48007	duži	25

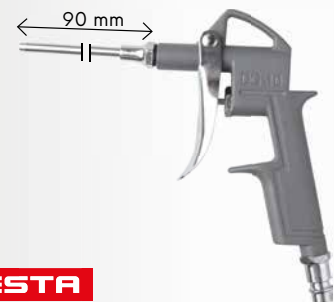

90 mm

FESTA

PIŠTOLJ RASPRŠIVAČ - DONJI



Broj	specifikacija	
48015	spodnji	1



800 ml

FESTA

PIŠTOLJ ZA PUKOTINE I OTVORE



Ø 1,4 mm

Broj	specifikacija	
48036	spodnji	1





30 cm

FESTA

TLAČNI PIŠTOLJ SA MANOMETROM

- 0 - 10 bar
- LCD display
- bar, kPa, Psi, kgf/cm²

2x AAA

Broj	specifikacija	
48011	0 - 10 bar	10



FESTA

TLAČNI PIŠTOLJ SA MANOMETROM

Broj	specifikacija	
48010		1



FESTA

KOMPRESOR KOMPLET

5x

- 1. pištolj raspršivač - donji
- 2. tlačni pištolj sa manometrom
- 3. pištolj raspršivač - gornji
- 4. zračni pištolj
- 5. spiralno crijevo sa priključcima

Broj	specifikacija	
48001		1



FESTA

KOMPRESOR KOMPLET

3x

- 1. tlačni pištolj sa manometrom
- 2. zračni pištolj
- 3. spiralno crijevo sa priključcima

Broj	specifikacija	
48002		1

NEW

ADAPTERI KOMPRESORA

8x

Broj	specifikacija	
48013		1



FESTA

SPIRALNO ČRIJEVO SA PRIKLJUČCIMA

Broj	specifikacija	
48043	5 m 8 atm ø 10 mm	1



FESTA

SPIRALNO ČRIJEVO SA PRIKLJUČCIMA

Broj	specifikacija	
48040	5 m 8 atm ø 8 mm	1
48041	10 m 8 atm ø 8 mm	1
48042	15 m 8 atm ø 8 mm	1



FESTA

SPIRALNO ČRIJEVO SA PRIKLJUČCIMA
· max. 20 Bar

Broj	specifikacija	
48031	5 m ø 9/15 mm	1
48032	10 m ø 9/15 mm	1
48033	15 m ø 9/15 mm	1
48034	20 m ø 9/15 mm	1

FESTA

FILTER

· maks. pritisak **10 bar**



Broj	specifikacija	
48008	G 1/4'	1

FESTA

REGULATOR PRITISKA

· radni pritisak **0 - 10 bar**



Broj	specifikacija	
48009	G 1/4'	1

FESTA

REZERVNE MLAZNICE

· pogodan za **48021**



Broj	specifikacija	
48047	mlaznice Ø 1,7 mm	1

FESTA

REZERVNE MLAZNICE

· pogodan za **48022**



Broj	specifikacija	
48046	mlaznice Ø 1,5 mm	1

TABELA MJERA CIJEVNIH PROMJERA I NAVOJA

VELIČINA NAVOJA G U INČIMA	MAKS. VANJSKI Ø NITI
1/8	9,728
1/4	13,157
3/8	16,662
1/2	20,955
3/4	26,441
1	33,249

BRZA SPOJNICA

Broj	specifikacija	
48075	1/4' vanjski	10
48076	3/8' vanjski	10
48077	1/2' vanjski	10
48095	1/4' unutarnji	10
48096	3/8' unutarnji	10
48097	1/2' unutarnji	10

DVOSTRUKI ADAPTER

Broj	specifikacija	
48050	veza 1/4' vanjski x 1/4' vanjski	10
48051	redukcija 1/4' vanjski x 3/8' vanjski	10

ADAPTER

Broj	specifikacija	
48054	3/8' vanjski x 1/4' unutarnji	10
48055	1/2' vanjski x 3/8' unutarnji	10
48056	redukcija 3/8' vanjski x 1/2' unutarnji	10
48057	redukcija 1/4' vanjski x 3/8' unutarnji	10

SPOJNICA

Broj	specifikacija	
48085	1/4' - 6 mm	10
48086	3/8' - 9 mm	10
48087	1/2' - 13 mm	10

ADAPTER

Broj	specifikacija	
48060	Ø 6 mm - 1/8' vanjski	10
48061	Ø 6 mm - 1/4' vanjski	10
48062	Ø 6 mm - 3/8' vanjski	10
48063	Ø 9 mm - 1/4' vanjski	10
48064	Ø 9 mm - 3/8' vanjski	10
48065	Ø 13 mm - 1/4' vanjski	10
48066	Ø 13 mm - 3/8' vanjski	10
48067	Ø 6 mm - 3/8' unutarnji	10
48068	Ø 9 mm - 3/8' unutarnji	10
48093	Ø 6 mm - 1/4' unutarnji	10
48094	Ø 9 mm - 1/4' unutarnji	10

ADAPTER SA VANJSKIM NAVOJEM

Broj	specifikacija	
48080	1/4' vanjski	10
48081	3/8' vanjski	10
48090	3/8' unutarnji	10
48091	1/4' unutarnji	10

BRZA SPOJNICA

Broj	specifikacija	
48070	1/4' - 6 mm	10
48071	3/8' - 9 mm	10
48072	1/2' - 13 mm	10



FESTA
POWER X TOOLS

PIŠTOLJ ZA VRUĆI ZRAK S REGULACIJOM

Napon	230V / 50Hz
Ulazna snaga	2000W
položaj prekidača	0 - I (350°C) - II (550°C)
prilobor	nehrđajućih produžetaka - 4 kom



Broj	specifikacija
35320	2000 W

1



FESTA
POWER X TOOLS

PIŠTOLJ ZA VRUĆI ZRAK S REGULACIJOM TEMPERATURE I REGULACIJOM ZRAKA

Napon	230V / 50Hz
Ulazna snaga	2000W
položaj prekidača	0 - I (50°C) - II (50 - 600°C)
protok zraka	120 - 500 l/min.
prilobor	nehrđajućih produžetaka - 4 kom



Broj	specifikacija
35322	2000 W

1

NEW



**WEST
BERG**
LEMILICA

230V
~ 50Hz **175W**

Broj	specifikacija
28275	
28278	lemni vrh 3kom



1

1



NEW



**WEST
BERG**
LEMILICA

230V
~ 50Hz **60W**

Broj	specifikacija
28280	
28282	lemni vrh 2kom



1

1



FESTA
POWER X TOOLS

**PIŠTOLJ ZA VRUĆE LJEPLJENJE
BEŽIČNI**

· Ø ljepilo štap 11,2 mm

230V
~ 50Hz **80W**



Broj specifikacija

89975

20

NEW

FESTA
POWER X TOOLS



**PIŠTOLJ
ZA VRUĆE LJEPLJENJE**

· Ø ljepilo štap 7,2 mm

230V
~ 50Hz **12W**



**PIŠTOLJ
ZA VRUĆE LJEPLJENJE**

· Ø ljepilo štap 7,2 mm

230V
~ 50Hz **15W**



**PIŠTOLJ
ZA VRUĆE LJEPLJENJE**

· Ø ljepilo štap 11,2 mm

230V
~ 50Hz **60W**



Broj specifikacija

89775

1

Broj specifikacija

89970

25

Broj specifikacija

89973

20



ULOŽAK ZA VRUĆE LJEPLJENJE

Broj	Ø	dužina		
89980	7,2 mm	100 mm	12 kom	100
89988	7,2 mm	100 mm	1 kg	25



ULOŽAK ZA VRUĆE LJEPLJENJE

Broj	Ø	dužina		
89985	11,2 mm	200 mm	10 kom	50
89987	11,2 mm	200 mm	1 kg	25



ULOŽAK ZA VRUĆE LJEPLJENJE

Broj	Ø	dužina		
89989	7,2 mm	100 mm	12 kom	100
89990	11,2 mm	200 mm	10 kom	50



ELEKTRIČNI GRIJAČ

Napon	230V ~50Hz
Izlaz	3300W
Opterećenje strujom	14.5A
Postavka snage	30/1650/3300W
Raspon temperature	5-40°C
Zaštita	IP24
Dimenzije	27 x 25.5 x 40cm
Težina	4.8 kg



- Brzo i učinkovito zagrijavanje podruma, radionica, prodavaonica, zabavnih šatora, staklenika i dr.
- Ne konzumira kisik
- Sigurno djelovanje, kontinuirana regulacija snage, sobni termostat, ventilator
- Grijači od nehrđajućeg čelika
- Mogućnost ljetne uporabe za ventilaciju bez grijanja
- Niska razina buke
- Visoka kvaliteta obrade, materijali, robusna čelična konstrukcija, lako i sigurno rukovanje, dugi vijek trajanja



Broj	specifikacija
35833	3,3 kW



1

PLINSKI GRIJAČ

Plin	G30-I3B/P
Tlak plina	0.7bar
Nazivni napon	230V 50Hz
Snaga motora	25W
Maksimalna potrošnja plina	1.11 kg/h
Maksimalna toplinska snaga	15kW
Makomimalni volumen vrućeg zraka	300m ³ /h

- Brzo i učinkovito grijanje tijekom građevinskih radova, radionica, itd.
- Konzumira kisik!
- Izravno grijanje zraka s prisilnom cirkulacijom - brzi ulaz topline
- Siguran rad, kontinuirana regulacija snage
- Termostat i sigurnosni ventil protiv pregrijavanja i propuštanja plina
- Uključeni pribor - regulator i crijeva za plin
- Visoka kvaliteta obrade, materijali, robusna čelična konstrukcija, lako i sigurno rukovanje, dugi vijek trajanja



Broj	specifikacija
35845	15 kW



1



PLINSKI GRIJAČ

Plin	G30-i3b/p
Tlak plina	1.5bar
Nazivni napon	230V 50Hz
Snaga motora	70W
Maksimalna potrošnja plina	2.2kg/h
Maksimalna toplinska snaga	30kW
Makomimalni volumen vrućeg zraka	750m ³ /h

- Brzo i učinkovito grijanje tijekom građevinskih radova, radionica, itd.
- Konzumira kisik!
- Izravno grijanje zraka s prisilnom cirkulacijom - brzi ulaz topline
- Siguran rad, kontinuirana regulacija snage
- Termostat i sigurnosni ventil protiv pregrijavanja i propuštanja plina
- Uključeni pribor - regulator i crijeva za plin
- Visoka kvaliteta obrade, materijali, robusna čelična konstrukcija, lako i sigurno rukovanje, dugi vijek trajanja



Broj	specifikacija
35850	30 kW



1





FESTA

LED REFLEKTOR



Broj	specifikacija	
37611		1



FESTA

LED REFLEKTOR SA DRŽAČEM

· max visina 180

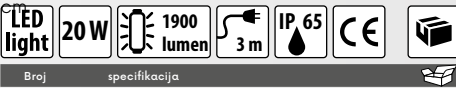

Broj	specifikacija	
37615	20 W	1
37616	2 x 20 W	1



NEW



FESTA
INDUSTRY

PRODUŽNI KABEL S KOLOTUROM

- rubber - IP44
- H07RN-F3G - 2,5mm²
- Opremljen je termičkim osiguračem
- 16 A max. / 3680 W max.
- 4 utičnice

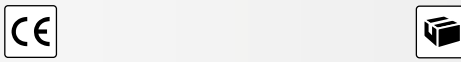

Broj	specifikacija	
37740	duljina 25 m, 2,5 mm ²	2
37741	duljina 50 m, 2,5 mm ²	2

NEW



FESTA
INDUSTRY

PRODUŽNI KABEL S KOLOTUROM

- rubber - IP44
- H05RR-F3G - 1,5mm²
- Opremljen je termičkim osiguračem
- 16 A max. / 3680 W max.
- 4 utičnice

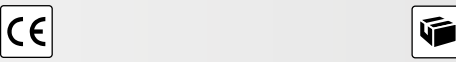

Broj	specifikacija	
37750	duljina 25 m, 1,5 mm ²	2
37751	duljina 50 m, 1,5 mm ²	2

FESTA

PRODUŽNI KABEL S KOLOTUROM

- IP20
- H05VV - F 3G 1,5mm²
- Opremljen je termičkim osiguračem
- Snaga zavarivanja: 1000 W max.
- Izlazna snaga: 3000 W max.
- 4 utičnice



Broj	specifikacija	
37760	duljina 25 m, 1,5 mm ²	2
37761	duljina 50 m, 1,5 mm ²	2

FESTA
INDUSTRY

PRODUŽNI KABEL

- rubber - IP44
- H07RN-F3G - 1,5mm²
- 16 A max. / 3680 W max.



Broj	specifikacija	
37744	duljina 5 m, 1,5 mm ²	8
37745	duljina 10 m, 1,5 mm ²	4
37746	duljina 20 m, 1,5 mm ²	8
37747	duljina 30 m, 1,5 mm ²	8

NEW

FESTA

PRODUŽNI KABEL

- IP20
- H05VV-F3G - 1,5mm²
- 16 A max. / 3680 W max.



Broj	specifikacija	
37730	duljina 10 m, 1,5 mm ²	8
37731	duljina 20 m, 1,5 mm ²	4
37732	NEW duljina 30 m, 1,5 mm ²	8
37733	NEW duljina 40 m, 1,5 mm ²	4





56

SVRDLA ZA METAL



63

SVRDLO I FREZA ZA DRVO



67

ZIDARSKA SVRDLA, DLIJETA



71

DIJAMANTNE KRUNE



74

DIJAMANTNE REZNE
PLOČE

76

REZNE PLOČE ZA METAL



80

ČETKA VALOVITA



82

PAPIR I LAMELNI DISK ZA
BRUŠENJE

86

UBODNE PILE

ALATI ZA BUŠENJE,
BRUŠENJE I REZANJE

54 - 93



FESTA

SVRDLA ZA METAL HSS-COBALT HSS-G COBALT 5 %



Broj	specifikacija		Broj	specifikacija		Broj	specifikacija	
22510	Ø 1,00 mm	1	22548	Ø 4,80 mm	1	22590	Ø 9,00 mm	1
22515	Ø 1,50 mm	1	22550	Ø 5,00 mm	1	22595	Ø 9,50 mm	1
22520	Ø 2,00 mm	1	22555	Ø 5,50 mm	1	22600	Ø 10,00 mm	1
22525	Ø 2,50 mm	1	22560	Ø 6,00 mm	1	22602	Ø 10,20 mm	1
22530	Ø 3,00 mm	1	22565	Ø 6,50 mm	1	22605	Ø 10,50 mm	1
22532	Ø 3,20 mm	1	22568	Ø 6,80 mm	1	22610	Ø 11,00 mm	1
22535	Ø 3,50 mm	1	22570	Ø 7,00 mm	1	22615	Ø 11,50 mm	1
22540	Ø 4,00 mm	1	22575	Ø 7,50 mm	1	22620	Ø 12,00 mm	1
22542	Ø 4,20 mm	1	22580	Ø 8,00 mm	1	22625	Ø 12,50 mm	1
22545	Ø 4,50 mm	1	22585	Ø 8,50 mm	1	22630	Ø 13,00 mm	1

**FESTA**

SVRDLA ZA METAL HSS-G W 9 %

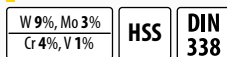

Broj	specifikacija		Broj	specifikacija		Broj	specifikacija		Broj	specifikacija	
19530	Ø 1,00 mm	10	19579	Ø 5,90 mm	5	19612	Ø 9,20 mm	5	19639	Ø 11,90 mm	3
19535	Ø 1,50 mm	10	19580	Ø 6,00 mm	5	19613	Ø 9,30 mm	5	19640	Ø 12,00 mm	3
19536	Ø 1,60 mm	10	19585	Ø 6,50 mm	5	19614	Ø 9,40 mm	5	19641	Ø 12,10 mm	3
19537	Ø 1,70 mm	10	19586	Ø 6,60 mm	5	19615	Ø 9,50 mm	3	19642	Ø 12,20 mm	3
19538	Ø 1,80 mm	10	19587	Ø 6,70 mm	5	19616	Ø 9,60 mm	3	19643	Ø 12,30 mm	3
19539	Ø 1,90 mm	10	19588	Ø 6,80 mm	5	19617	Ø 9,70 mm	3	19644	Ø 12,40 mm	3
19540	Ø 2,00 mm	10	19589	Ø 6,90 mm	5	19618	Ø 9,80 mm	3	19645	Ø 12,50 mm	3
19543	Ø 2,30 mm	10	19590	Ø 7,00 mm	5	19619	Ø 9,90 mm	3	19646	Ø 12,60 mm	1
19544	Ø 2,40 mm	10	19591	Ø 7,10 mm	5	19620	Ø 10,00 mm	3	19647	Ø 12,70 mm	1
19545	Ø 2,50 mm	10	19593	Ø 7,30 mm	5	19621	Ø 10,10 mm	3	19648	Ø 12,80 mm	1
19550	Ø 3,00 mm	10	19594	Ø 7,40 mm	5	19622	Ø 10,20 mm	3	19649	Ø 12,90 mm	1
19552	Ø 3,20 mm	10	19595	Ø 7,50 mm	5	19623	Ø 10,30 mm	3	19650	Ø 13,00 mm	1
19554	Ø 3,40 mm	10	19596	Ø 7,60 mm	5	19624	Ø 10,40 mm	3	19651	Ø 13,20 mm R13	1
19555	Ø 3,50 mm	10	19597	Ø 7,70 mm	5	19625	Ø 10,50 mm	3	19652	Ø 13,50 mm R13	1
19557	Ø 3,70 mm	10	19598	Ø 7,80 mm	5	19626	Ø 10,60 mm	3	19653	Ø 14,00 mm R13	1
19559	Ø 3,90 mm	10	19599	Ø 7,90 mm	5	19627	Ø 10,70 mm	3	19654	Ø 14,50 mm R13	1
19560	Ø 4,00 mm	10	19600	Ø 8,00 mm	5	19628	Ø 10,80 mm	3	19655	Ø 15,00 mm R13	1
19562	Ø 4,20 mm	10	19601	Ø 8,10 mm	5	19629	Ø 10,90 mm	3	19656	Ø 15,50 mm R13	1
19564	Ø 4,40 mm	10	19603	Ø 8,30 mm	5	19630	Ø 11,00 mm	3	19657	Ø 16,00 mm R13	1
19565	Ø 4,50 mm	10	19604	Ø 8,40 mm	5	19631	Ø 11,10 mm	3	19658	Ø 16,50 mm R13	1
19567	Ø 4,70 mm	10	19605	Ø 8,50 mm	5	19632	Ø 11,20 mm	3	19659	Ø 17,00 mm R13	1
19568	Ø 4,80 mm	10	19606	Ø 8,60 mm	5	19633	Ø 11,30 mm	3	19660	Ø 17,50 mm R13	1
19570	Ø 5,00 mm	5	19607	Ø 8,70 mm	5	19634	Ø 11,40 mm	3	19661	Ø 18,00 mm R13	1
19574	Ø 5,40 mm	5	19608	Ø 8,80 mm	5	19635	Ø 11,50 mm	3	19662	Ø 18,50 mm R13	1
19575	Ø 5,50 mm	5	19609	Ø 8,90 mm	5	19636	Ø 11,60 mm	3	19663	Ø 19,00 mm R13	1
19576	Ø 5,60 mm	5	19610	Ø 9,00 mm	5	19637	Ø 11,70 mm	3	19664	Ø 19,50 mm R13	1
19577	Ø 5,70 mm	5	19611	Ø 9,10 mm	5	19638	Ø 11,80 mm	3	19665	Ø 20,00 mm R13	1
19578	Ø 5,80 mm	5									

**FESTA**

BOX - SVRDLA ZA METAL HSS-G W 9 %

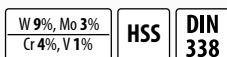

Broj	specifikacija	
19669		1
90191	bez svrdla	1



Broj	sadržaj seta	Broj	sadržaj seta
19530	Ø 1,00 mm 20x	19585	Ø 6,50 mm 15x
19535	Ø 1,50 mm 20x	19590	Ø 7,00 mm 15x
19540	Ø 2,00 mm 20x	19595	Ø 7,50 mm 15x
19545	Ø 2,50 mm 20x	19600	Ø 8,00 mm 15x
19550	Ø 3,00 mm 20x	19605	Ø 8,50 mm 15x
19552	Ø 3,20 mm 20x	19610	Ø 9,00 mm 15x
19555	Ø 3,50 mm 20x	19615	Ø 9,50 mm 15x
19558	Ø 3,80 mm 20x	19620	Ø 10,00 mm 15x
19560	Ø 4,00 mm 30x	19625	Ø 10,50 mm 6x
19562	Ø 4,20 mm 20x	19630	Ø 11,00 mm 6x
19565	Ø 4,50 mm 20x	19635	Ø 11,50 mm 6x
19568	Ø 4,80 mm 20x	19640	Ø 12,00 mm 6x
19570	Ø 5,00 mm 15x	19645	Ø 12,50 mm 6x
19575	Ø 5,50 mm 15x	19650	Ø 13,00 mm 6x
19580	Ø 6,00 mm 30x		

FESTA

SVRDLA ZA METAL HSS 4241

W 4%, Mo 3%
Cr 4%, V 1%

HSS

DIN
338

ALU 900 MPa



MOQ

Broj	specifikacija		Broj	specifikacija		Broj	specifikacija		Broj	specifikacija	
19670	Ø 0,6 mm	10	19703	Ø 4,0 mm	10	19736	Ø 7,3 mm	10	19769	Ø 10,6 mm	5
19671	Ø 0,8 mm	10	19704	Ø 4,1 mm	10	19737	Ø 7,4 mm	10	19770	Ø 10,7 mm	5
19672	Ø 0,9 mm	10	19705	Ø 4,2 mm	10	19738	Ø 7,5 mm	10	19771	Ø 10,8 mm	5
19673	Ø 1,0 mm	10	19706	Ø 4,3 mm	10	19739	Ø 7,6 mm	10	19772	Ø 11,0 mm	5
19674	Ø 1,1 mm	10	19707	Ø 4,4 mm	10	19740	Ø 7,7 mm	10	19773	Ø 11,2 mm	5
19675	Ø 1,2 mm	10	19708	Ø 4,5 mm	10	19741	Ø 7,8 mm	10	19774	Ø 11,3 mm	5
19676	Ø 1,3 mm	10	19709	Ø 4,6 mm	10	19742	Ø 7,9 mm	10	19775	Ø 11,4 mm	5
19677	Ø 1,4 mm	10	19710	Ø 4,7 mm	10	19743	Ø 8,0 mm	10	19776	Ø 11,5 mm	5
19678	Ø 1,5 mm	10	19711	Ø 4,8 mm	10	19744	Ø 8,1 mm	10	19777	Ø 11,6 mm	5
19679	Ø 1,6 mm	10	19712	Ø 4,9 mm	10	19745	Ø 8,2 mm	10	19778	Ø 11,7 mm	5
19680	Ø 1,7 mm	10	19713	Ø 5,0 mm	10	19746	Ø 8,3 mm	10	19779	Ø 11,8 mm	5
19681	Ø 1,8 mm	10	19714	Ø 5,1 mm	10	19747	Ø 8,4 mm	10	19780	Ø 11,9 mm	5
19682	Ø 1,9 mm	10	19715	Ø 5,2 mm	10	19748	Ø 8,5 mm	10	19781	Ø 12,0 mm	5
19683	Ø 2,0 mm	10	19716	Ø 5,3 mm	10	19749	Ø 8,6 mm	5	19782	Ø 12,2 mm	5
19684	Ø 2,1 mm	10	19717	Ø 5,4 mm	10	19750	Ø 8,7 mm	5	19783	Ø 12,5 mm	5
19685	Ø 2,2 mm	10	19718	Ø 5,5 mm	10	19751	Ø 8,8 mm	5	19784	Ø 12,8 mm	5
19686	Ø 2,3 mm	10	19719	Ø 5,6 mm	10	19752	Ø 8,9 mm	5	19785	Ø 12,9 mm	5
19687	Ø 2,4 mm	10	19720	Ø 5,7 mm	10	19753	Ø 9,0 mm	5	19786	Ø 13,0 mm	5
19688	Ø 2,5 mm	10	19721	Ø 5,8 mm	10	19754	Ø 9,1 mm	5	19787	Ø 13,2 mm R13	5
19689	Ø 2,6 mm	10	19722	Ø 5,9 mm	10	19755	Ø 9,2 mm	5	19788	Ø 13,5 mm R13	5
19690	Ø 2,7 mm	10	19723	Ø 6,0 mm	10	19756	Ø 9,3 mm	5	19789	Ø 14,0 mm R13	5
19691	Ø 2,8 mm	10	19724	Ø 6,1 mm	10	19757	Ø 9,4 mm	5	19790	Ø 14,5 mm R13	5
19692	Ø 2,9 mm	10	19725	Ø 6,2 mm	10	19758	Ø 9,5 mm	5	19791	Ø 15,0 mm R13	5
19693	Ø 3,0 mm	10	19726	Ø 6,3 mm	10	19759	Ø 9,6 mm	5	19792	Ø 15,5 mm R13	5
19694	Ø 3,1 mm	10	19727	Ø 6,4 mm	10	19760	Ø 9,7 mm	5	19793	Ø 16,0 mm R13	5
19695	Ø 3,2 mm	10	19728	Ø 6,5 mm	10	19761	Ø 9,8 mm	5	19794	Ø 16,5 mm R13	5
19696	Ø 3,3 mm	10	19729	Ø 6,6 mm	10	19762	Ø 9,9 mm	5	19795	Ø 17,0 mm R13	5
19697	Ø 3,4 mm	10	19730	Ø 6,7 mm	10	19763	Ø 10,0 mm	5	19796	Ø 17,5 mm R13	5
19698	Ø 3,5 mm	10	19731	Ø 6,8 mm	10	19764	Ø 10,1 mm	5	19797	Ø 18,0 mm R13	5
19699	Ø 3,6 mm	10	19732	Ø 6,9 mm	10	19765	Ø 10,2 mm	5	19798	Ø 18,5 mm R13	5
19700	Ø 3,7 mm	10	19733	Ø 7,0 mm	10	19766	Ø 10,3 mm	5	19799	Ø 19,0 mm R13	5
19701	Ø 3,8 mm	10	19734	Ø 7,1 mm	10	19767	Ø 10,4 mm	5	19800	Ø 19,5 mm R13	5
19702	Ø 3,9 mm	10	19735	Ø 7,2 mm	10	19768	Ø 10,5 mm	5	19801	Ø 20,0 mm R13	5

FESTA

BOX - SVRDLA ZA METAL HSS 4241

W 4%, Mo 3%
Cr 4%, V 1%

HSS

DIN
338

ALU 900 MPa



Broj	sadržaj seta	Broj	sadržaj seta
19673	Ø 1,00 mm 20x	19728	Ø 6,50 mm 20x
19678	Ø 1,50 mm 20x	19733	Ø 7,00 mm 10x
19683	Ø 2,00 mm 20x	19738	Ø 7,50 mm 10x
19688	Ø 2,50 mm 20x	19743	Ø 8,00 mm 10x
19693	Ø 3,00 mm 30x	19748	Ø 8,50 mm 10x
19695	Ø 3,20 mm 30x	19753	Ø 9,00 mm 10x
19698	Ø 3,50 mm 30x	19758	Ø 9,50 mm 10x
19701	Ø 3,80 mm 30x	19763	Ø 10,00 mm 10x
19703	Ø 4,00 mm 30x	19768	Ø 10,50 mm 10x
19705	Ø 4,20 mm 30x	19772	Ø 11,00 mm 10x
19708	Ø 4,50 mm 30x	19776	Ø 11,50 mm 10x
19711	Ø 4,80 mm 30x	19781	Ø 12,00 mm 10x
19713	Ø 5,00 mm 20x	19783	Ø 12,50 mm 10x
19718	Ø 5,50 mm 20x	19786	Ø 13,00 mm 5x
19723	Ø 6,00 mm 20x		

Broj	specifikacija	
19802		1
90192	bez svrdla	1

FESTA

HSS SVRDLA ZA METAL - PRODUŽENI

W 4%, Mo 3%
Cr 4%, V 1%

HSS

DIN
340

ALU



MOQ

Broj	specifikacija		Broj	specifikacija		Broj	specifikacija	
20220	Ø 2,0 mm x 85 mm	1	20245	Ø 4,5 mm x 126 mm	1	20280	Ø 8,0 mm x 165 mm	1
20225	Ø 2,5 mm x 95 mm	1	20250	Ø 5,0 mm x 132 mm	1	20290	Ø 9,0 mm x 175 mm	1
20230	Ø 3,0 mm x 100 mm	1	20255	Ø 5,5 mm x 139 mm	1	20296	Ø 10,0 mm x 184 mm	1
20235	Ø 3,5 mm x 110 mm	1	20260	Ø 6,0 mm x 139 mm	1			
20240	Ø 4,0 mm x 119 mm	1	20270	Ø 7,0 mm x 156 mm	1			

SVRDLA ZA METAL HSS TITAN

vrh od titana omogućuje veću učinkovitost i vijek trajanja

TiN HSS DIN 338



Broj.	specifikacija	
20400	Ø 1,0 mm	1
20401	Ø 1,5 mm	1
20402	Ø 2,0 mm	1
20403	Ø 2,5 mm	1
20404	Ø 3,0 mm	1
20405	Ø 3,2 mm	1
20406	Ø 3,5 mm	1
20407	Ø 3,8 mm	1
20408	Ø 4,0 mm	1
20409	Ø 4,2 mm	1
20410	Ø 4,5 mm	1

Broj.	specifikacija	
20411	Ø 4,8 mm	1
20412	Ø 5,0 mm	1
20413	Ø 5,5 mm	1
20414	Ø 6,0 mm	1
20415	Ø 6,5 mm	1
20416	Ø 6,8 mm	1
20417	Ø 7,0 mm	1
20418	Ø 7,5 mm	1
20419	Ø 8,0 mm	1
20420	Ø 8,5 mm	1
20421	Ø 9,0 mm	1

Broj.	specifikacija	
20422	Ø 9,5 mm	1
20423	Ø 10,0 mm	1
20424	Ø 10,2 mm	1
20425	Ø 10,5 mm	1
20426	Ø 11,0 mm	1
20427	Ø 11,5 mm	1
20428	Ø 12,0 mm	1
20429	Ø 12,5 mm	1
20430	Ø 13,0 mm	1

HSS SVRDLA ZA METAL

HSS DIN 338

ALU



Broj.	specifikacija	
19841	Ø 4,1 mm 5 ks	10
19842	Ø 4,2 mm 5 ks	10
19845	Ø 4,5 mm 5 ks	10
19885	Ø 8,5 mm 1 ks	10
19895	Ø 9,5 mm 1 ks	10



FESTA

KOMPLET BRUŠENIH SVRDLA ZA METAL

W 9%, Mo 3%
Cr 4%, V 1% HSS DIN 338

13x



INOX

Broj.	specifikacija	
20333	Ø 1,5 - 6,5 mm	20



FESTA

KOMPLET BRUŠENIH SVRDLA ZA METAL

W 9%, Mo 3%
Cr 4%, V 1% HSS DIN 338

19x



INOX

Broj.	specifikacija	
20334	Ø 1,0 - 10,0 mm	20



FESTA

KOMPLET BRUŠENIH SVRDLA ZA METAL

W 9%, Mo 3%
Cr 4%, V 1% HSS DIN 338

25x



INOX

Broj.	specifikacija	
20335	Ø 1,0 - 13,0 mm	5



FESTA

SVRDLA ZA METAL

W 4%, Mo 3%
Cr 4%, V 1% HSS DIN 338

13x



Broj.	specifikacija	
20336	Ø 1,5 - 6,5 mm	1



FESTA

SVRDLA ZA METAL

W 4%, Mo 3%
Cr 4%, V 1% HSS DIN 338

19x



Broj.	specifikacija	
20337	Ø 1,0 - 10,0 mm	20



FESTA

SVRDLA ZA METAL

W 4%, Mo 3%
Cr 4%, V 1% HSS DIN 338

25x



Broj.	specifikacija	
20338	Ø 1,0 - 13,0 mm	10

FESTA

SVRDLA ZA METAL

TiN



9x



Broj	specifikacija	
20317	Ø 5-6-8 mm	20

FESTA

SVRDLA SA ŠESTEROKUTNIM PRHVTOM

1/4" HSS



7x



Broj	specifikacija	
20316	Ø 1,5-2-3-4-5-5,5-6 mm	20



SVRDLA ZA METAL

HSS DIN 338



19x



Broj	specifikacija	
20305	Ø 1,0 - 13,0 mm	25

SVRDLA ZA METAL

HSS DIN 338



25x



Broj	specifikacija	
20311	Ø 1,0 - 13,0 mm	10

SVRDLA ZA METAL

HSS DIN 338



13x



Broj	specifikacija	
20300	Ø 1,5 - 6,5 mm	50

SVRDLA ZA METAL

HSS DIN 338



19x

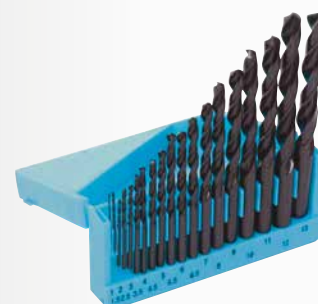

Broj	specifikacija	
20310	Ø 1 - 13 mm	10

KOMPLET SVRDALA

- svrdlo za drvo \varnothing 3 · 4 · 5 · 6 · 8 mm
- svrdlo za metal \varnothing 1 · 1,5 · 2 · 2,5 · 3 · 3,5 · 4 · 4,5 · 5 · 5,5 · 6 · 7 · 8 · 10 mm
- svrdlo za zidanje \varnothing 4 · 5 · 6 · 8 · 10 mm
- plosnato svrdlo za drvo \varnothing 16 · 22 · 25 mm
- kružna pila \varnothing 32 · 38 · 44 · 54 mm
- graničnici dubine \varnothing 6 · 8 · 10 mm
- točkasti probijač
- mjerač promjera svrdla

- bit 25 mm S 3 · 4 · 4 · 5 · 5 · 6 · 6 · 7
- PH 0 · 0 · 1 · 1 · 2 · 2 · 2 · 3 · 3
- PZ 0 · 0 · 1 · 1 · 2 · 2 · 2 · 3 · 3
- H 2 · 2,5 · 3 · 3,5 · 4 · 5 · 6
- T 10 · 15 · 20 · 25 · 27 · 30 · 40
- bit 50 mm S 4 · 5 · 6 · 6
- PH 1 · 2 · 2 · 3
- PZ 1 · 2 · 2 · 3
- adapter \varnothing 4 · 5 · 6 · 7 · 8 · 9 · 10 · 13 mm



SVRDLA ZA METAL

HSS DIN 338



19x

100x

Broj specifikacija

20340



1

Broj specifikacija

20315 \varnothing 1 - 10 mm

10

SVRDLA ZA METAL

TiN HSS DIN 338



19x

Broj specifikacija

20320 \varnothing 1 - 10 x 0,5 mm



30



SVRDLA ZA METAL

HSS DIN 338



19x

Broj specifikacija

20321 \varnothing 1 - 10 x 0,5 mm



5



OŠTRAČ ZA SVRDLA

Broj specifikacija

20380 za \varnothing 3,5 - 10 mm



20

FESTA IZREZIVAČ RUPA BI-METAL



Broj	specifikacija	
24419	\varnothing 19 mm	1
24420	\varnothing 20 mm	1
24422	\varnothing 22 mm	1
24425	\varnothing 25 mm	1
24429	\varnothing 29 mm	1
24432	\varnothing 32 mm	1
24435	\varnothing 35 mm	1
24437	\varnothing 37 mm	1
24444	\varnothing 44 mm	1
24451	\varnothing 51 mm	1
24457	\varnothing 57 mm	1
24464	\varnothing 64 mm	1
24468 NEW	\varnothing 68 mm	1
24476	\varnothing 76 mm	1
24483	\varnothing 83 mm	1



FESTA NOSAČ ZA IZREZIVAČ RUPA

Broj specifikacija

24410 izrezivač rupa 14 - 30 mm



1



FESTA NOSAČ ZA IZREZIVAČ RUPA

Broj specifikacija

24411 izrezivač rupa 32 - 152 mm



1



FESTA REZERVNO SVRDOLO ZA NOSAČ ZA IZREZIVAČ RUPA

za 24410, 24411

Broj specifikacija

24412



5



FESTA

KOMPLET
IZREZIVAČA RUPA,
HSS BI-METAL



9x

Broj	specifikacija	10
24750	Ø 19, 22, 29, 38, 44, 57 mm	



FESTA

KOMPLET
IZREZIVAČA RUPA,
HSS BI-METAL



13x

Broj	specifikacija	10
24751	Ø 19, 22, 29, 35, 38, 44, 51, 57, 64 mm	



FESTA

SVRDLO STUPNJEVITO TIN



Broj	specifikacija	10
20489	Ø 4 - 12 mm 9 koraka	20
20490	Ø 4 - 20 mm 9 koraka	10
20491	Ø 5 - 35 mm 13 koraka	10
20492	Ø 7 - 40,5 mm 13 koraka	5



FESTA

SVRDLO STUPNJEVITO TIN
KOMPLET



3x

Broj	specifikacija	1
20495	Ø 4 - 12, 4 - 20, 4 - 32 mm	



SVRDLO STUPNJEVITO HSS

HSS



Broj	specifikacija	1
20487	Ø 4 - 20 mm 9 koraka	10
20488	Ø 5 - 35 mm 13 koraka	10
20494	Ø 4 - 32 mm 15 koraka	10
20493	Ø 7 - 40,5 mm 13 koraka	1



SVRDLO STUPNJEVITO HSS
KOMPLET

HSS



3x

Broj	specifikacija	1
20496	Ø 4 - 12, 4 - 20, 4 - 32 mm	





FESTA

KOMPLET ZA VAĐENJE SLOMLJENIH VIJAKA

- Ø 4 mm Ø 11 mm
- Ø 4,5 mm Ø 15 mm
- Ø 6,5 mm Ø 19 mm
- Ø 7,5 mm Ø 24 mm

8x

Broj	specifikacija	
20387		5



FESTA

KOMPLET ZA VAĐENJE SLOMLJENIH VIJAKA

- Ø 4 mm
- Ø 4,5 mm
- Ø 6 mm
- Ø 7,5 mm
- Ø 11 mm

5x

Broj	specifikacija	
20386		10



KOMPLET ZA VAĐENJE SLOMLJENIH VIJAKA

- Ø 4 mm
- Ø 4,5 mm
- Ø 6 mm
- Ø 7,5 mm
- Ø 11 mm

5x

Broj	specifikacija	
20385		10



DRŽAČ UREZNICA

Broj	specifikacija	
20397	M3 - M8	10



FESTA

DRŽAČ NAREZNICA

DIN 225

Broj	specifikacija	
20396	25 x 9 mm	10



FESTA

DRŽAČ UREZNICA

DIN 1814

Broj	specifikacija	
20394	M5 - M20	10
20395	1 - 1/2; M3 - M12	10



FESTA

KOMPLET UREZNICA I NAREZNICA

32x

Broj	specifikacija	
20391	M 3, 4, 5, 6, 8, 10, 12 mm	1



FESTA

KOMPLET UREZNICA

21x

Broj	specifikacija	
20390	M 3, 4, 5, 6, 8, 10, 12 mm	1

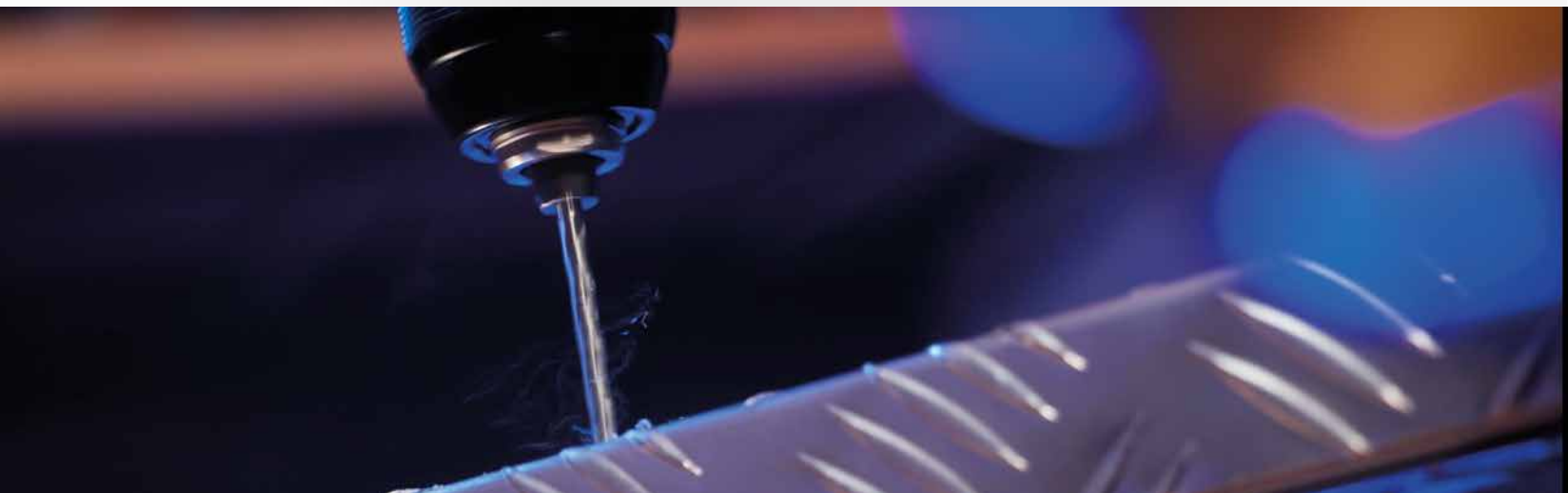

NEW

FESTA

FORSTNER SVRDLO

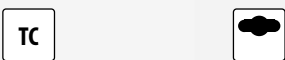

Broj	specifikacija	
21531	Ø 15 mm	1
21532	Ø 20 mm	1
21533	Ø 25 mm	1
21534	Ø 30 mm	1
21535	Ø 35 mm	1
21536	Ø 40 mm	1



FESTA



FESTA

UVOJITO SVRDLO



Broj	specifikacija	
20980	Ø 6 x 230 mm	1
20957	Ø 6 x 300 mm	1
20981	Ø 8 x 230 mm	1
20958	Ø 8 x 300 mm	1
20982	Ø 10 x 230 mm	1
20896	Ø 10 x 300 mm	1
20913	Ø 10 x 450 mm	1
20983	Ø 12 x 230 mm	1
20897	Ø 12 x 300 mm	1
20915	Ø 12 x 450 mm	1
20920	Ø 12 x 600 mm	1
20898	Ø 14 x 300 mm	1
20916	Ø 14 x 450 mm	1
20921	Ø 14 x 600 mm	1

Broj	specifikacija	
20984	Ø 16 x 230 mm	1
20899	Ø 16 x 300 mm	1
20917	Ø 16 x 450 mm	1
20922	Ø 16 x 600 mm	1
20918	Ø 18 x 450 mm	1
20923	Ø 18 x 600 mm	1
20919	Ø 20 x 450 mm	1
20924	Ø 20 x 600 mm	1
20724	Ø 22 x 450 mm	1
20725	Ø 24 x 450 mm	1
20726	Ø 26 x 450 mm	1
20727	Ø 28 x 450 mm	1
20728	Ø 30 x 450 mm	1

FESTA

KOMPLET UVOJITIH SVRDALA



5x

Broj	specifikacija	
20911	Ø 8, 10, 12, 14, 16 x 460 mm	10



FESTA

KOMPLET UVOJITIH SVRDALA



6x

Broj	specifikacija	
20912	Ø 6, 8, 10, 12, 16, 20 x 230 mm	10



SVRDLO



Broj	specifikacija	
20729	Ø 6 x 400 mm	1
20731	Ø 8 x 400 mm	1
20736	Ø 8 x 600 mm	1
20730	Ø 10 x 400 mm	1
20737	Ø 10 x 600 mm	1



Broj	specifikacija	
20732	Ø 12 x 400 mm	1
20738	Ø 12 x 600 mm	1
20733	Ø 14 x 400 mm	1
20739	Ø 14 x 600 mm	1

Broj	specifikacija	
20734	Ø 16 x 400 mm	1
20740	Ø 16 x 600 mm	1
20735	Ø 18 x 400 mm	1
20741	Ø 18 x 600 mm	1

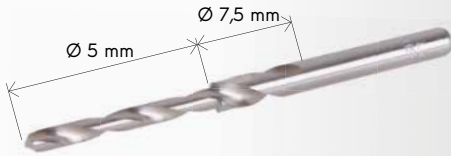

FESTA
SVRDLO



Broj	specifikacija	
20210	Ø 7,5, 5 mm	1



KOMPLET SVRDALA ZA DRVO



Broj	specifikacija	
21440	Ø 4 x 75 mm	1
21441	Ø 5 x 85 mm	1
21442	Ø 6 x 90 mm	1
21443	Ø 7 x 105 mm	1
21444	Ø 8 x 115 mm	1
21445	Ø 9 x 120 mm	1
21446	Ø 10 x 120 mm	1



FREZA



Broj	specifikacija	
20460	Ø 6 mm	50



KOMPLET SVRDALA ZA DRVO



Broj	specifikacija	
20910	8 kom Ø 3, 4, 5, 6, 7, 8, 9, 10 mm	10
20905	5 kom Ø 4, 5, 6, 8, 10 mm	10



FORSTNER - KOMPLET SVRDALA ZA DRVO



Broj	specifikacija	
21530	Ø 15, 20, 25, 30, 35 mm Ø 8 mm 20	20



KOMPLET FREZA TITAN HSS



Broj	specifikacija	
20450	Ø 3, 4, 5, 6, 6,5, 8 mm	20

KOMPLET SVRDALA ZA DRVO



Broj	specifikacija	
20901	Ø 10, 12, 16, 18, 20, 25 mm	20



RUČNA SVRDLA

HOBBY



Broj	specifikacija	
20381	Ø 2, 3, 4, 5 mm	20





FESTA

**KRUŽNA PILA
KOMPLET**

- Ø 19 mm
- Ø 22 mm
- Ø 25,5 mm
- Ø 36 mm
- Ø 44 mm
- Ø 51 mm
- Ø 60 mm
- Ø 67 mm
- Ø 76 mm
- Ø 82 mm
- imbus
- 2x glava



12x

Broj	specifikacija	
24712	6 tpi	20



FESTA

**KRUŽNA PILA
KOMPLET**

- Ø 64 mm
- Ø 73 mm
- Ø 89 mm
- Ø 102 mm
- Ø 127 mm
- imbus
glava



8x

Broj	specifikacija	
24706	6 tpi	20



FESTA

**SVRDLO SA KRUNOM
PODESIVO**

Ø 19 - 127 mm



Broj	Specifikacija	
24415	Ø 19 - 127 mm	maksimalna dubina 29 mm 6

FESTA

KRUŽNA PILA



Broj	specifikacija	
24715	1' Ø 67 mm 6 tpi	5
24713	1' Ø 73 mm 6 tpi	5
24714	1' Ø 102 mm 6 tpi	5
24720	1' Ø 152 mm 6 tpi	5



KRUŽNA PILA KOMPLET



Broj	specifikacija	
24721	1' Ø 26, 32, 38, 45, 50, 56, 63 mm	10
24722	2' Ø 26, 32, 38, 45, 50, 56, 63 mm	10

**IZREZIVAČ
VARIJABILNI**



Broj	specifikacija	
24716	Ø 30 - 120 mm	5

FESTA

ROTACIONE TURPIJICE

M14

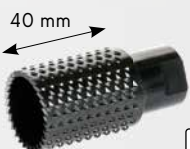

Broj	specifikacija	
21807	Ø 30 mm / 60 mm	1

FESTA

ROTACIONE TURPIJICE

M14



Broj	specifikacija	
21808	Ø 30 mm / 105 mm	10



ROTACIONE
TURPIJICE

5x



Broj 21541 specifikacija 25



ROTACIONI BRUSEVI

5x



Broj 21540 specifikacija Ø 3 mm, 6 mm 12

KOMPLET
ROTACIONIH
BRUSEVA

190x



Broj 24755 specifikacija 5

KOMPLET
ROTACIONIH
BRUSEVA

150x



Broj 24756 specifikacija 10



PROFIL FREZA ZA DRVO



5x



Broj 21450 specifikacija Ø 8 mm 10



PROFIL FREZA ZA DRVO



12x



Broj 21451 specifikacija Ø 8 mm 10



PROFIL FREZA ZA DRVO



24x



Broj 21452 specifikacija Ø 8 mm 1

PROFIL FREZA
ZA DRVO



35x



Broj 21453 specifikacija Ø 8 mm 1

PROFIL FREZA
ZA DRVO



59x



Broj 21454 specifikacija Ø 8 mm 1

FESTA

SVRDLO ZA ZID

DIN 8039



dvije oštrice



Broj	specifikacija	A mm	B mm	
20673	Ø 3 mm	60	30	100
20674	Ø 4 mm	75	40	100
20675	Ø 5 mm	85	50	100
20676	Ø 6 mm	100	60	100
20677	Ø 6 mm	200	160	50
20685	Ø 6 mm	300	260	50
20678	Ø 8 mm	120	75	50
20686	Ø 8 mm	200	155	50

Broj	specifikacija	A mm	B mm	
20687	Ø 8 mm	300	255	25
20688	Ø 8 mm	400	340	25
20680	Ø 10 mm	120	70	50
20690	Ø 10 mm	200	150	50
20691	Ø 10 mm	300	250	25
20692	Ø 10 mm	400	340	25
20682	Ø 12 mm	150	100	50
20694	Ø 12 mm	300	250	25

Broj	specifikacija	A mm	B mm	
20696	Ø 12 mm	400	340	25
20684	Ø 14 mm	150	90	25
	reduction Ø 10 mm			
20697	Ø 14 mm	300	240	5
	reduction Ø 10 mm			
20698	Ø 14 mm	400	340	15
	reduction Ø 10 mm			

FESTA

SVRDLO ZA ZID SDS+

SDS+



dvije oštrice



Broj	specifikacija	A mm	B mm	
20855	Ø 14 mm	160	75	

25

FESTA

SVRDLO ZA ZID SDS+

SDS+

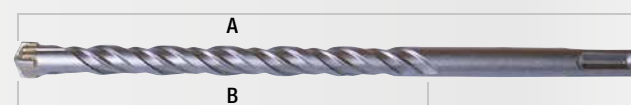

svrdlo sa 4 oštrice-veća učinkovitost i vijek trajanja



Broj	specifikacija	A mm	B mm	
20748	Ø 6 mm	110	40	50
20749	Ø 6 mm	160	90	50
20750	Ø 6 mm	210	140	50
20751	Ø 6 mm	260	190	50
20861	Ø 6,5 mm	230	160	50
20862	Ø 6,5 mm	300	230	50
20752	Ø 8 mm	110	40	50
20753	Ø 8 mm	160	90	50
20754	Ø 8 mm	210	140	50
20755	Ø 8 mm	260	190	50
20825	Ø 8 mm	350	280	50
20756	Ø 10 mm	160	90	50
20757	Ø 10 mm	210	140	50
20758	Ø 10 mm	260	190	50
20759	Ø 10 mm	350	280	50
20760	Ø 10 mm	450	380	50
20761	Ø 10 mm	600	530	50
20762	Ø 10 mm	1000	930	50
20764	Ø 12 mm	160	80	50
20765	Ø 12 mm	210	130	50
20766	Ø 12 mm	260	180	50
20767	Ø 12 mm	350	270	50

Broj	specifikacija	A mm	B mm	
20768	Ø 12 mm	460	380	50
20769	Ø 12 mm	600	520	25
20770	Ø 12 mm	1000	920	25
20771	Ø 14 mm	160	80	25
20772	Ø 14 mm	260	180	25
20773	Ø 14 mm	350	270	25
20774	Ø 14 mm	460	380	25
20775	Ø 14 mm	600	520	25
20776	Ø 14 mm	1000	920	30
20777	Ø 16 mm	160	80	25
20778	Ø 16 mm	210	130	25
20779	Ø 16 mm	260	180	25
20780	Ø 16 mm	350	270	25
20781	Ø 16 mm	460	380	25
20782	Ø 16 mm	600	520	30
20783	Ø 16 mm	1000	920	25
20784	Ø 18 mm	260	180	25
20785	Ø 18 mm	450	370	25
20786	Ø 18 mm	600	520	32
20787	Ø 18 mm	1000	920	20
20788	Ø 20 mm	450	370	20
20789	Ø 20 mm	600	520	20

Broj	specifikacija	A mm	B mm	
20790	Ø 20 mm	800	720	25
20791	Ø 20 mm	1000	920	10
20792	Ø 22 mm	450	365	20
20793	Ø 22 mm	600	520	20
20794	Ø 22 mm	800	715	20
20795	Ø 22 mm	1000	920	10
20796	Ø 24 mm	450	365	10
20797	Ø 24 mm	600	520	20
20798	Ø 24 mm	800	715	10
20799	Ø 24 mm	1000	920	10
20870	Ø 26 mm	450	370	10
20871	Ø 26 mm	650	570	20
20872	Ø 26 mm	800	720	10
20873	Ø 26 mm	1000	920	10
20874	Ø 28 mm	450	365	10
20875	Ø 28 mm	600	565	20
20876	Ø 28 mm	800	715	10
20877	Ø 28 mm	1000	915	10
20878	Ø 30 mm	450	365	10
20879	Ø 30 mm	600	565	20
20880	Ø 30 mm	800	715	10
20881	Ø 30 mm	1000	915	10

FESTA

SVRDLO ZA ZID SDS MAX

SDS MAX

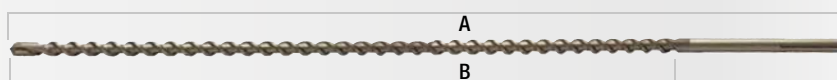

svrdlo sa 4 oštrice-veća učinkovitost i vijek trajanja



Broj	specifikacija	A mm	B mm	
20508	Ø 16 mm	550	395	5
20510	Ø 18 mm	550	395	5
20520	Ø 18 mm	800	650	5
20511	Ø 20 mm	550	395	5
20521	Ø 20 mm	800	650	5

Broj	specifikacija	A mm	B mm	
20512	Ø 22 mm	550	395	5
20522	Ø 22 mm	800	650	5
20513	Ø 24 mm	550	395	5
20523	Ø 24 mm	800	650	5
20514	Ø 28 mm	550	395	5

Broj	specifikacija	A mm	B mm	
20524	Ø 28 mm	800	650	5
20515	Ø 30 mm	550	395	5
20525	Ø 30 mm	800	650	5
20516	Ø 40 mm	550	395	2
20526	Ø 40 mm	800	650	1

KOMPLET SDS+ SVRDLA

5x SDS+



Broj	specifikacija		
20890	Ø 5, 6, 8, 10, 12 mm 160 mm		25



KOMPLET SDS+ SVRDLA

6x SDS+



Broj	specifikacija		
20891	Ø 5, 6, 8 mm 110 mm Ø 8, 10, 12 mm 160 mm		25



KOMPLET SVRDLA

6x DIN 8039



Broj	specifikacija		
20895	Ø 5, 6, 8, 10, 12 mm		25



SVRDLA ZA ZID



Broj	specifikacija		
20805	5 kom Ø 4 - 10 mm		10
20820	8 kom Ø 3 - 10 mm		10



FESTA

KOMPLET SJEKAČA SDS+

SDS+

4x



Broj	specifikacija		
20954	250 mm		1

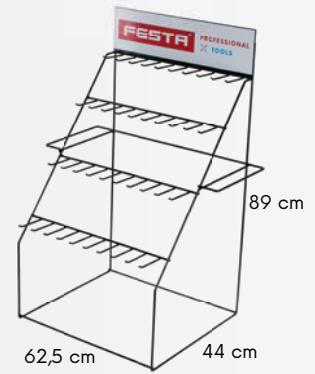

PROMOTIVNI STALAK

Broj	specifikacija		
20999			1

FESTA

KOMPLET SJEKAČA I SVRDLA SDS+

- 2 x špica
- 3 x sjekač
- 12 x svrdlo Ø 5-12 mm

17x SDS+



Broj	specifikacija		
20952			1



FESTA

KOMPLET SJEKAČA I SVRDLA SDS+

- 1 x špica 250 mm
- 1 x sjekač žljebasti 22 x 250 mm
- 1 x sjekač 20 x 250 mm

- Ø 5 x 110 mm
- Ø 6 x 110 mm
- Ø 8 x 160 mm
- Ø 10 x 160 mm
- Ø 12 x 160 mm
- Ø 14 x 210 mm
- Ø 16 x 210 mm
- Ø 18 x 310 mm
- Ø 20 x 450 mm

12x SDS+



Broj	specifikacija		
20950			5



FESTA

SJEKAČ ZA UDARNU BUŠILICU

SDS+



Broj	specifikacija		
20996	250 x 100 mm		1



NEW



FESTA

SJEKAČ ZA UDARNU BUŠILICU

SDS+

Broj	specifikacija	
20997	445 x 130 mm	1

NEW

FESTA

SJEKAČ ZA UDARNU BUŠILICU

SDS MAX



Broj	specifikacija	
20932	450 x 100 mm	1

FESTA

SJEKAČ ZA UDARNU BUŠILICU, 15°

SDS+



Broj	specifikacija	
20936	40 x 250 mm	5

FESTA

SJEKAČ ZA UDARNU BUŠILICU

SDS+



Broj	specifikacija	
20948	20 x 250 mm	25
20990	20 x 400 mm	25
20949	40 x 250 mm	25
20991	40 x 400 mm	25

FESTA

SJEKAČ ZA UDARNU BUŠILICU

SDS MAX



Broj	specifikacija	
20940	25 x 280 mm	5
20941	40 x 280 mm	5
20942	75 x 280 mm	5
20943	25 x 400 mm	5
20944	40 x 400 mm	5
20945	25 x 600 mm	5
20946	50 x 600 mm	5

FESTA

ŠPICA ZA UDARNU BUŠILICU

SDS+



Broj	specifikacija	
20947	250 mm	25
20992	400 mm	25

FESTA

SJEKAČ ŽLJEBASTI

SDS+



Broj	specifikacija	
20956	22 x 250 mm	25

FESTA

ŠPICA ZA UDARNU BUŠILICU

SDS MAX



Broj	specifikacija	
20937	Ø 18 x 280 mm	5
20938	Ø 18 x 400 mm	5
20939	Ø 18 x 600 mm	2

FESTA

STEZNE KARIKE ZA SVRDLA

SDS MAX



Broj	specifikacija	
24730	180 mm	1

FESTA

SVRDLO SA KRUNOM SDS+

SDS+



Broj	specifikacija	
24719	Ø 67 mm	1
24717	Ø 73 mm	1
24723	Ø 80 mm	1
24718	Ø 100 mm	1
24757	Ø 115 mm	1
24758	Ø 125 mm	1
24759	Ø 150 mm	1

• stezne karike za svrdla 24730, 24731 a 24732

FESTA

STEZNE KARIKE ZA SVRDLA

SDS+



Broj	specifikacija	
24731	300 mm	1
24732		1

**FESTA**

KRUNE ZA IZREZIVANJE RUPA



6x



Broj	specifikacija	
24745	Ø 33, 53, 67, 73 mm + nosač, svrdlo	1

FESTA

KRUNE ZA IZREZIVANJE RUPA



8x

Broj	specifikacija	
24747	Ø 33, 53, 67, 73, 83 mm nosač, svrdlo, turpija	1

**FESTA**

KRUNA ZA IZREZIVANJE RUPA



Broj	specifikacija	
24735	Ø 33 mm	1
24736	Ø 43 mm	1
24737	Ø 53 mm	1
24738	Ø 67 mm	1
24739	Ø 73 mm	1
24740	Ø 83 mm	1
24741	Ø 103 mm	1

**FESTA**

KRUNE ZA IZREZIVANJE RUPA

3x



Broj	specifikacija	
24746	Ø 103 mm + nosač, svrdla	1

**FESTA**

CENTRIR SVRDLO ZA KRUNE



Broj	specifikacija	
24749		50

**FESTA**

NOSAČ KRUNE

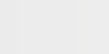

Broj	specifikacija	
24748	Ø 33 - 83 mm	10
24743	Ø 33 - 103 mm	10

**FESTA**

KRUNA - KARBID

- za bušenje stakla i keramike
- potrebno je hlađenje



Broj	specifikacija	
24770	Ø 4 mm	1
24771	Ø 6 mm	1
24772	Ø 8 mm	1
24773	Ø 10 mm	1
24774	Ø 12 mm	1



IZREZIVAČ RUPA SA ŠTITNIKOM

Broj	specifikacija	
24726	Ø 20-95mm	1

IZREZIVAČ RUPA ZA KERAMIKU

Broj	specifikacija	
24725	Ø 20-95mm	10

**FESTA**

TURPIJA ZA OBRADU KERAMIČKIH PLOČICA



Broj	specifikacija	
22200	160 mm	20

**FESTA**

TURPIJA ZA OBRADU KERAMIČKIH PLOČICA

- za brušenje cigle prije umetanja zidnog sidra



Broj	specifikacija	
22201	200 mm dvostruko jedno	20





DIJAMANTNA KRUNA SET

- Ø 6 mm
- Ø 8 mm
- Ø 10 mm
- Ø 12 mm
- Ø 20 mm
- Ø 28 mm
- Ø 35 mm
- Ø 45 mm
- Ø 55 mm
- Ø 68 mm

ploče rezne / brusne Ø 125 mm x 2,0 mm Ø 22,2 mm
 ploče rezne Ø 125 mm x 1,2 mm Ø 22,2 mm

dijamantna kruga za brušenje Ø 0 - 50 mm
 dijamantna abrazivna spužvica 90 x 55 mm P60

13x **M14**

- keramičke pločice
- mramor
- granit

· nepotrebno je hlađenje



Broj	Specifikacija	
24652		1



DIJAMANTNA KRUNA

M14

- keramičke pločice
- mramor
- granit

· nepotrebno je hlađenje



Broj	Specifikacija	
24620	Ø 6 mm	M14
24621	Ø 8 mm	M14
24622	Ø 10 mm	M14
24623	Ø 12 mm	M14
24624	Ø 14 mm	M14
24627	Ø 20 mm	M14
24630	Ø 28 mm	M14
24633	Ø 35 mm	M14
24636	Ø 45 mm	M14
24638	Ø 55 mm	M14
24640	Ø 68 mm	M14
24642	Ø 72 mm	M14
24643	Ø 75 mm	M14



DIJAMANTNA KRUNA SET

- Ø 6 mm
- Ø 8 mm
- Ø 10 mm
- Ø 20 mm
- Ø 35 mm
- Ø 45 mm
- Ø 55 mm
- Ø 68 mm

8x **M14**

- keramičke pločice
- mramor
- granit

· nepotrebno je hlađenje



Broj	Specifikacija	
24651		1



DIJAMANTNA KRUNA ZA BRUŠENJE

M14

- keramičke pločice
- mramor
- granit

· nepotrebno je hlađenje



Broj	Specifikacija	
24795	Ø 20 / 50 mm	1
24797	Ø 6 / 50 mm	1
24799	Ø 10 / 50 mm	1



DIJAMANTNA KRUNA ZA BRUŠENJE

M14

- keramičke pločice
- mramor
- granit

· nepotrebno je hlađenje



Broj	Specifikacija	
24775	NEW Ø 2 - 35 mm	1
24777	Ø 2 - 75 mm	1
24778	Ø 2 - 50 mm	1



· Ø 2 mm - Ø 75 mm



DIJAMANTNA KRUNA ZA BRUŠENJE

M14

- keramičke pločice
- mramor
- granit

nepotrebno je hlađenje

Broj	Specifikacija	
24779	Ø 20 - 48 mm	1



DIJAMANTNA KRUNA ZA BRUŠENJE

M14

- keramičke pločice
- mramor
- granit

nepotrebno je hlađenje

Broj	Specifikacija	
24663	Ø 50 mm	1



NEW



DIJAMANTNA KRUNA

M14

- keramičke pločice
- mramor
- granit

nepotrebno je hlađenje

Broj	specifikacija	učyt		Broj	specifikacija	učyt	
24760	Ø 6 mm	M14	1	24766	Ø 35 mm	M14	1
24761	Ø 8 mm	M14	1	24776	Ø 40 mm	M14	1
24762	Ø 10 mm	M14	1	24767	Ø 45 mm	M14	1
24763	Ø 12 mm	M14	1	24791	Ø 50 mm	M14	1
24764	Ø 14 mm	M14	1	24768	Ø 53 mm	M14	1
24670	Ø 16 mm	M14	1	24792	Ø 60 mm	M14	1
24671	Ø 18 mm	M14	1	24793	Ø 65 mm	M14	1
24790	Ø 20 mm	M14	1	24769	Ø 68 mm	M14	1
24672	Ø 22 mm	M14	1	24794	Ø 75 mm	M14	1
24673	Ø 25 mm	M14	1	24796	Ø 83 mm	M14	1
24765	Ø 28 mm	M14	1	24677	Ø102 mm	M14	1
24674	Ø 30 mm	M14	1	24676	Ø 110 mm	M14	1
24675	Ø 32 mm	M14	1	24678	Ø125 mm	M14	1



DIJAMANTNA KRUNA ZA BRUŠENJE

M14

- keramičke pločice
- mramor
- granit

nepotrebno je hlađenje

Broj	Specifikacija	
24661	Ø 50 mm	1



NEW



DIJAMANTNA KRUNA

7x M14

- keramičke pločice
- mramor
- granit

nepotrebno je hlađenje

Broj	Specifikacija	
24650		1

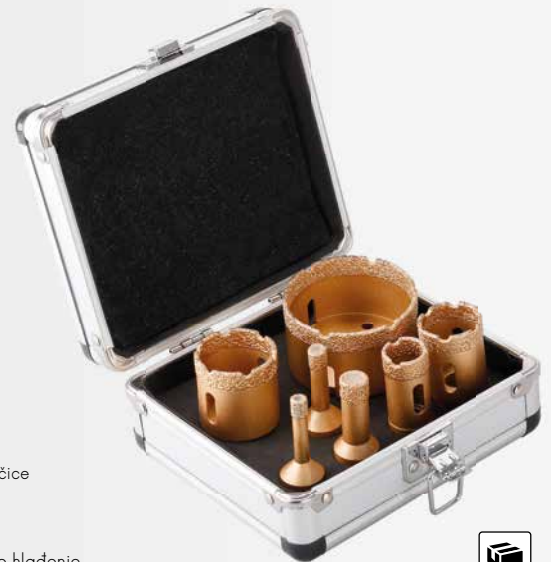

- Ø 8 mm
- Ø 10 mm
- Ø 14 mm
- Ø 22 mm
- Ø 32 mm
- Ø 40 mm
- Ø 68 mm



DIJAMANTNA KRUNA

- keramičke pločice
- mramor
- granit

Broj	specifikacija	
24700	Ø 6 mm	1
24701	Ø 8 mm	1
24702	Ø 10 mm	1
24703	Ø 12 mm	1
24704	Ø 14 mm	1
24705	Ø 20 mm	1



FESTA

RASHLADNI VOSAK
ZA DIJAMANTNU
PILU ZA RUPE



Broj	Specifikacija	
24710	30 ml	1

FESTA

DIJAMANTNA
KRUNA



6x

- keramičke pločice
- mramor
- granit

Broj	specifikacija	
24798	Ø 6, 8, 10, 12, 14, 20 mm	1



FESTA

DIJAMANTNA
PLOČA ZA REZANJE
I BRUŠENJE

M14

- keramičke pločice
- mramor
- granit

- nepotrebno je hlađenje

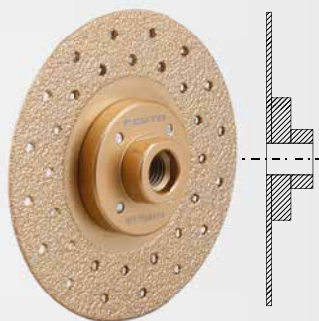

Broj	Specifikacija	
24655	Ø 115 mm M14	1

FESTA

DIJAMANTNA PLOČA ZA
BRUŠENJE

- keramičke pločice
- mramor
- granit

- nepotrebno je hlađenje

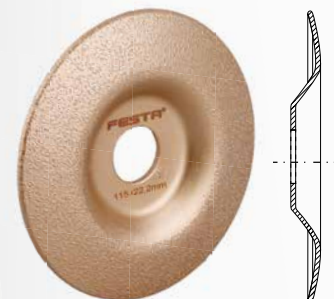

Broj	Specifikacija	
24658	Ø 115 mm Ø 22,2 mm	1

FESTA

SVRDLO ZA STAKLO
I KERAMIKU

TiN 1/4"

- keramičke pločice
- mramor
- granit

Broj	specifikacija	
24780	Ø 4 mm	40
24781	Ø 5 mm	40
24782	Ø 6 mm	40
24783	Ø 8 mm	40
24784	Ø 10 mm	40
24785	Ø 12 mm	40
24786	Ø 14 mm	1
24787	Ø 16 mm	1
24788	Ø 18 mm	1
24789	Ø 20 mm	1



FESTA

SVRDLO ZA STAKLO I
KERAMIKU - KOMPLET

- Ø 4 mm
- Ø 5 mm
- Ø 6 mm
- Ø 8 mm
- Ø 10 mm

5x

- keramičke pločice
- mramor
- granit

- nepotrebno je hlađenje



Broj	specifikacija	
24734		1



DIJAMANTNE PLOČE REZNE / BRUSNE

- keramičke pločice
- mramor
- granit
- nepotrebno je hla enje



DIJAMANTNE REZNE PLOČE TURBO EXTREME

- keramičke pločice
- mramor
- granit
- nepotrebno je hla enje

Broj	specifikacija		
21230	Ø 115 mm x 1,8 mm	Ø 22,2 mm	1
21231	Ø 125 mm x 2,0 mm	Ø 22,2 mm	1

Broj	specifikacija		
21205	Ø 125 mm x 2,0 mm	Ø 22,2 mm	1
21209	Ø 230 mm x 2,6 mm	Ø 22,2 mm	1



DIJAMANTNE REZNE PLOČE

- keramičke pločice
- mramor
- granit
- nepotrebno je hla enje

Broj	specifikacija		
21234 NEW	Ø 115 mm x 1,2 x 8 mm	Ø 22,2 mm	1
21235	Ø 125 mm x 1,2 x 8 mm	Ø 22,2 mm	1
21238 NEW	Ø 200 mm x 1,6 x 11 mm	Ø 25,4 mm	1



DIJAMANTNE REZNE PLOČE

- keramičke pločice
- mramor
- granit
- nepotrebno je hla enje

Broj	specifikacija		
21200	Ø 115 mm 1,4 mm	Ø 22,2 mm	1
21201	Ø 125 mm 1,4 mm	Ø 22,2 mm	1
21204	Ø 200 mm 1,8 mm	Ø 25,4 mm	1
21203	Ø 230 mm 1,8 mm	Ø 22,2 mm	1



FESTA

DIJAMANTNE REZNE PLOČE SEGMENTNE

Broj	specifikacija		
21311	Ø 115 mm	Ø 22,2 mm	1
21312	Ø 125 mm	Ø 22,2 mm	1
21315	Ø 150 mm	Ø 22,2 mm	1
21318	Ø 180 mm	Ø 22,2 mm	1
21323	Ø 230 mm	Ø 22,2 mm	1
21324	Ø 300 mm	Ø 25,4 mm	1
21327	Ø 350 mm	Ø 25,4 mm	1
21326	Ø 400 mm	Ø 25,4 mm	1



FESTA

DIJAMANTNE REZNE PLOČE TURBO

Broj	specifikacija		
21411	Ø 115 mm	Ø 22,2 mm	1
21412	Ø 125 mm	Ø 22,2 mm	1
21415	Ø 150 mm	Ø 22,2 mm	1
21418	Ø 180 mm	Ø 22,2 mm	1
21423	Ø 230 mm	Ø 22,2 mm	1
21424	Ø 300 mm	Ø 25,4 mm	1



FESTA

DIJAMANTNE REZNE PLOČE PUNE

Broj	specifikacija		
21210	Ø 110 mm	Ø 22,2 mm	1
21211	Ø 115 mm	Ø 22,2 mm	1
21212	Ø 125 mm	Ø 22,2 mm	1
21215	Ø 150 mm	Ø 22,2 mm	1
21218	Ø 180 mm	Ø 22,2 mm	1
21219	Ø 180 mm	Ø 25,4 mm	1
21220	Ø 200 mm	Ø 25,4 mm	1
21223	Ø 230 mm	Ø 22,2 mm	1
21224	Ø 300 mm	Ø 25,4 mm	1



FESTA
INDUSTRY

DIJAMANTNE REZNE PLOČE UNIVERZALNE



Broj	specifikacija		
21301	Ø 125 mm	Ø 22,2 mm 1,5 mm	1
21303	Ø 230 mm	Ø 22,2 mm 1,8 mm	1



FESTA

DIJAMANTNE BRUSNE PLOČE



Broj	specifikacija	
21195	Ø 125 x 22,2 mm	1



6 mm



DIJAMANTNE REZNE PLOČE PUNE

Broj	specifikacija		
21010	Ø 110 mm	Ø 22,2 mm	1
21011	Ø 115 mm	Ø 22,2 mm	1
21012	Ø 125 mm	Ø 22,2 mm	1
21015	Ø 150 mm	Ø 22,2 mm	1
21018	Ø 180 mm	Ø 22,2 mm	1
21023	Ø 230 mm	Ø 22,2 mm	1



DIJAMANTNE REZNE PLOČE SEGMENTNE

Broj	specifikacija		
21110	Ø 110 mm	Ø 22,2 mm	1
21111	Ø 115 mm	Ø 22,2 mm	1
21112	Ø 125 mm	Ø 22,2 mm	1
21115	Ø 150 mm	Ø 22,2 mm	1
21118	Ø 180 mm	Ø 22,2 mm	1
21123	Ø 230 mm	Ø 22,2 mm	1



DIJAMANTNE REZNE PLOČE TURBO

Broj	specifikacija		
21130	Ø 110 mm	Ø 22,2 mm	1
21135	Ø 115 mm	Ø 22,2 mm	1
21140	Ø 125 mm	Ø 22,2 mm	1
21150	Ø 150 mm	Ø 22,2 mm	1
21180	Ø 180 mm	Ø 22,2 mm	1
21190	Ø 230 mm	Ø 22,2 mm	1





FESTA

DIJAMANTNE BRUSNE PLOČE



Broj	specifikacija		
21435	Ø 115 mm	Ø 22,2 mm	1
21436	Ø 125 mm	Ø 22,2 mm	1
21437	Ø 150 mm	Ø 22,2 mm	1



FESTA

DIJAMANTNE BRUSNE PLOČE



Broj	specifikacija		
21430	Ø 115 mm	Ø 22,2 mm	1
21431	Ø 125 mm	Ø 22,2 mm	1
21432	Ø 150 mm	Ø 22,2 mm	1



FESTA

DIJAMANTNE BRUSNE PLOČE (ZA ŠLICANJE)



Broj	specifikacija		
21425	Ø 100 mm	Ø 22,2 mm	1
21426	Ø 115 mm	Ø 22,2 mm	1
21427	Ø 125 mm	Ø 22,2 mm	1
21428	Ø 150 mm	Ø 22,2 mm	1



FESTA
INDUSTRY

REZNE PLOČE ZA METAL



Broj	specifikacija		
22258	Ø 115 mm	Ø 22,2 mm x 0,8 mm	25
22260	Ø 115 mm	Ø 22,2 mm x 1 mm	25
22263	Ø 115 mm	Ø 22,2 mm x 1,6 mm	25
22264	Ø 115 mm	Ø 22,2 mm x 2 mm	25
22259	Ø 125 mm	Ø 22,2 mm x 0,8 mm	25
22266	Ø 125 mm	Ø 22,2 mm x 1 mm	25
22269	Ø 125 mm	Ø 22,2 mm x 1,6 mm	25
22270	Ø 125 mm	Ø 22,2 mm x 2 mm	25
22273	Ø 150 mm	Ø 22,2 mm x 1,6 mm	25
22274	Ø 150 mm	Ø 22,2 mm x 2 mm	25
22275	Ø 150 mm	Ø 22,2 mm x 2,5 mm	25
22277	Ø 180 mm	Ø 22,2 mm x 2 mm	25
22280	Ø 230 mm	Ø 22,2 mm x 2 mm	25
22281	Ø 230 mm	Ø 22,2 mm x 2,5 mm	25



FESTA
INDUSTRY

REZNE PLOČE ZA ALUMINIJ



Broj	specifikacija		
22285	Ø 115 mm	Ø 22,2 mm x 1 mm	1
22286	Ø 125 mm	Ø 22,2 mm x 1 mm	1



FESTA
INDUSTRY

REZNE PLOČE ZA KAMEN



Broj	specifikacija		
22294	Ø 230 mm	Ø 22,2 mm x 3 mm	1



FESTA

REZNE PLOČE ZA METAL



Broj	specifikacija			
22211	Ø 115 mm	Ø 22,2 mm x 1 mm	INOX	50
22212	Ø 115 mm	Ø 22,2 mm x 1,2 mm	INOX	50
22225	Ø 125 mm	Ø 22,2 mm x 1 mm	INOX	50
22217	Ø 125 mm	Ø 22,2 mm x 1,2 mm	INOX	50

FESTA

REZNE PLOČE ZA METAL

10x



Broj	specifikacija			
22228	Ø 115 mm	Ø 22,2 mm x 1 mm	INOX	1
22229	Ø 125 mm	Ø 22,2 mm x 1,2 mm	INOX	1

FESTA

REZNE PLOČE ZA METAL



Broj	specifikacija			
22251	Ø 115 mm	Ø 22,2 mm x 1,6 mm		50
22215	Ø 115 mm	Ø 22,2 mm x 2 mm		50
22216	Ø 115 mm	Ø 22,2 mm x 2,5 mm		50
22252	Ø 125 mm	Ø 22,2 mm x 1,6 mm		25
22218	Ø 125 mm	Ø 22,2 mm x 2,5 mm		25
22219	Ø 150 mm	Ø 22,2 mm x 1,2 mm		25
22253	Ø 150 mm	Ø 22,2 mm x 1,6 mm		50
22220	Ø 150 mm	Ø 22,2 mm x 2,5 mm		50
22254	Ø 180 mm	Ø 22,2 mm x 1,6 mm		50
22222	Ø 180 mm	Ø 22,2 mm x 2,5 mm		25
22255	Ø 230 mm	Ø 22,2 mm x 1,6 mm		25
22224	Ø 230 mm	Ø 22,2 mm x 2,5 mm		25

FESTA

BRUSNE PLOČE ZA METAL



Broj	specifikacija			
22240	Ø 115 mm	Ø 22,2 mm x 6,4 mm		25
22242	Ø 125 mm	Ø 22,2 mm x 6,4 mm		25
22244	Ø 150 mm	Ø 22,2 mm x 6,4 mm		25
22246	Ø 180 mm	Ø 22,2 mm x 6,4 mm		25
22248	Ø 230 mm	Ø 22,2 mm x 6,4 mm		25

FESTA

DIJAMANTNE REZNE PLOČE ZA METAL



Broj	specifikacija			
21306	Ø 125 mm	Ø 22,2 mm	1,3 mm	1
21308	Ø 230 mm	Ø 22,2 mm	1,8 mm	1

FESTA

REZNE PLOČE ZA KAMEN



Broj	specifikacija			
22230	Ø 115 mm	Ø 22,2 mm x 2,5 mm		50
22232	Ø 125 mm	Ø 22,2 mm x 2,5 mm		50
22234	Ø 150 mm	Ø 22,2 mm x 2,5 mm		25
22236	Ø 180 mm	Ø 22,2 mm x 2,5 mm		25
22238	Ø 230 mm	Ø 22,2 mm x 2,5 mm		25

FESTA

REZNE PLOČE UNIVERZALNE CARBID



Broj	specifikacija			
21192	Ø 125 mm	Ø 22,2 mm		1
21194	Ø 230 mm	Ø 22,2 mm		1

FESTA
BRUSNA PLOČA

Broj	specifikacija		
21806	Ø 125 mm	Ø 22,2 mm	1

FESTA
BRUSNA PLOČA
SREDNJE GRUBA

Broj	specifikacija		
21802	Ø 125 mm	Ø 22,2 mm 3 mm	10

FESTA
BRUSNA PLOČA
GRUBA

Broj	specifikacija		
21801	Ø 125 mm	Ø 22,2 mm 3 mm	10

FESTA
BRUSNO /
REZNA PLOČA

Broj	specifikacija		
21803	Ø 125 mm	Ø 22,2 mm	1

FESTA
BRUŠNA
PLOČA

Broj	specifikacija		
21805	Ø 125 mm	Ø 22,2 mm	1

FESTA
DISK ZA DRVO

· disk pogodan za brušenje drva

Broj	specifikacija		
21800	Ø 125 mm	Ø 22,2 mm	1

FESTA
ROTACIONE TURPIJICE

M14

Broj	specifikacija		
21807	Ø 30 mm / 60 mm		1

FESTA
ROTACIONE TURPIJICE

M14

Broj	specifikacija		
21808	Ø 30 mm / 105 mm		10

FESTA
REZNA PLOČA

Broj	specifikacija		
21804	Ø 125 mm	Ø 22,2 mm 14T	1

NEW

REZNA PLOČA ZA DRVO



Broj	Specifikacija		
21809	Ø 125 mm x 4T	Ø 22,2 mm	1

NEW

FESTA

LAMEL-DISK



INOX



Broj	specifikacija	oštrina	
21760	Ø 125 mm Ø 22,2 mm	P40	10
21761	Ø 125 mm Ø 22,2 mm	P60	10
21762	Ø 125 mm Ø 22,2 mm	P80	10
21763	Ø 125 mm Ø 22,2 mm	P100	10
21764	Ø 125 mm Ø 22,2 mm	P120	10

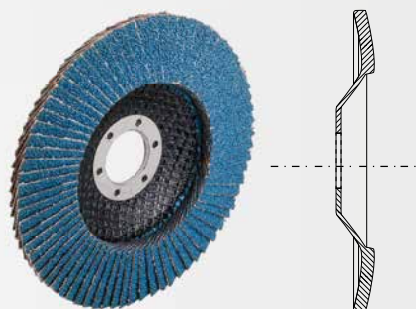

FESTA

LAMEL-DISK

disk za brušenje inox-a



INOX

Broj	specifikacija	oštrina	
22140	Ø 115 mm Ø 22,2 mm	P40	5
22141	Ø 115 mm Ø 22,2 mm	P60	5
22142	Ø 115 mm Ø 22,2 mm	P80	5
22143	Ø 115 mm Ø 22,2 mm	P100	5
22145	Ø 125 mm Ø 22,2 mm	P40	5
22146	Ø 125 mm Ø 22,2 mm	P60	5
22147	Ø 125 mm Ø 22,2 mm	P80	5
22148	Ø 125 mm Ø 22,2 mm	P100	5
22150	Ø 150 mm Ø 22,2 mm	P40	5
22151	Ø 150 mm Ø 22,2 mm	P60	5
22155	Ø 150 mm Ø 22,2 mm	P80	5
22156	Ø 150 mm Ø 22,2 mm	P100	5

NEW

FESTA
INDUSTRY

LAMEL-DISK DIJAMANTNI



- keramičke pločice
- mramor
- granit



Broj	specifikacija			
24647	Ø 115 mm Ø 22,2 mm	Ø 22,2 mm	● P60	1
24648	Ø 115 mm Ø 22,2 mm	Ø 22,2 mm	● P120	1
24649	Ø 115 mm Ø 22,2 mm	Ø 22,2 mm	● P200	1

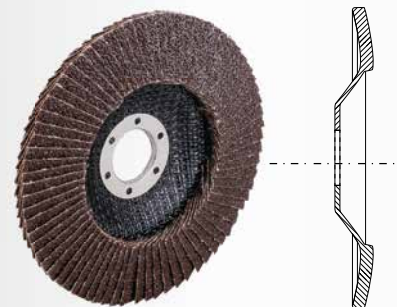

LAMEL-DISK



Broj	specifikacija	oštrina	
21780	Ø 115 mm Ø 22,2 mm	P40	10
21781	Ø 115 mm Ø 22,2 mm	P60	10
21782	Ø 115 mm Ø 22,2 m	P80	10
21783	Ø 115 mm Ø 22,2 mm	P100	10
21784	Ø 115 mm Ø 22,2 mm	P120	10
21786	Ø 125 mm Ø 22,2 mm	P40	10
21787	Ø 125 mm Ø 22,2 mm	P60	10
21788	Ø 125 mm Ø 22,2 mm	P80	10
21789	Ø 125 mm Ø 22,2 mm	P100	10
21790	Ø 125 mm Ø 22,2 mm	P120	10
21792	Ø 150 mm Ø 22,2 mm	P40	10
21793	Ø 150 mm Ø 22,2 mm	P60	10
21794	Ø 150 mm Ø 22,2 mm	P80	10
21795	Ø 150 mm Ø 22,2 mm	P100	10
21796	Ø 150 mm Ø 22,2 mm	P120	10

ČETKA NYLON



Broj	specifikacija	
21798	Ø 125 mm Ø 22,2 mm	1



FESTA



FESTA

ČETKA

· mesing

M14

Broj	specifikacija	Žice	š	š
21900	Ø 100 mm M14	s 0,3	60	
21902	Ø 125 mm M14	s 0,3	42	



FESTA

ČETKA

· mesing

M14

Broj	specifikacija	Žice	š	š
22001	Ø 100 mm M14	s 0,3	60	
21901	Ø 125 mm M14	s 0,3	42	



FESTA

ČETKA

· mesing

M14

Broj	specifikacija	Žice	š	š
21920	Ø 100 mm M14	s 0,3	60	



FESTA

ČETKA VALOVITA

· mesing

M14

Broj	specifikacija	Žice	š	š
21903	Ø 65 mm M14	s 0,3	60	
22002	Ø 75 mm M14	s 0,3	80	
21904	Ø 85 mm M14	s 0,3	60	
22003	Ø 100 mm M14	s 0,3	36	
21905	Ø 125 mm M14	s 0,3	24	
21906	Ø 150 mm M14	s 0,3	12	



FESTA

ČETKA VALOVITA

· mesing

M14

Broj	specifikacija	Žice	š	š
21925	Ø 75 mm M14	0,3 mm	80	
21926	Ø 100 mm M14	0,3 mm	36	



FESTA

ČETKA VALOVITA

· mesing

· redukcijski prstenovi

M14

Broj	specifikacija	Žice	š	š
22007	Ø 100 mm Ø 20 mm	s 0,3	60	
22008	Ø 125 mm Ø 20 mm	s 0,3	42	
22009	Ø 150 mm Ø 32,2 mm	s 0,3	32	
22010	Ø 175 mm Ø 32,2 mm	s 0,3	20	
22011	Ø 200 mm Ø 32,2 mm	s 0,3	20	



FESTA

ČETKA PLETENA - ROST-FREI

· kaljena

INOX M14

Broj	specifikacija	Žice	š	š
22037	Ø 65 mm M14	s 0,5	60	
22038	Ø 80 mm M14	s 0,5	24	



FESTA

ČETKA PLETENA

· kaljena

M14

Broj	specifikacija	Žice	š	š
22004	Ø 65 mm M14	s 0,3	60	
22005	Ø 75 mm M14	s 0,3	24	
22006	Ø 100 mm M14	s 0,3	24	
21907	Ø 125 mm M14	s 0,3	24	
21908	Ø 150 mm M14	s 0,3	12	



FESTA

ČETKA RADIJALNA, PLETENA

· kaljena

M14

Broj	specifikacija	Žice	počet copū	š
21911	Ø 100 mm M14	s 0,5	30	60
21912	Ø 115 mm M14	s 0,5	32	42
21913	Ø 125 mm M14	s 0,5	36	42
21914	Ø 150 mm M14	s 0,5	40	32



FESTA

ČETKA RADIJALNA, PLETENA

kaljena

M14

Broj	specifikacija	Žice	
22012	Ø 100 mm M14	s 0,5	60
22013	Ø 115 mm M14	s 0,5	42
22014	Ø 125 mm M14	s 0,5	42
22015	Ø 150 mm M14	s 0,5	32
22016	Ø 178 mm M14	s 0,5	20



FESTA

ČETKA RADIJALNA, PLETENA

kaljena

INOX M14

Broj	specifikacija	Žice	
22039	Ø 100 mm M14	s 0,5	60
22040	Ø 125 mm M14	s 0,5	42



FESTA

ČETKA PLETENA

kaljena

M14

Broj	specifikacija	Žice	
22017	Ø 100 mm M14	s 0,5	60
21909	Ø 115 mm M14	s 0,5	42
21910	Ø 125 mm M14	s 0,5	42



FESTA

ČETKA RADIJALNA, PLETENA

kaljena

Broj	specifikacija	Žice	
22023	Ø 75 mm	s 0,5	10



FESTA

ČETKA PLETENA

kaljena

Broj	specifikacija	Žice	
22024	Ø 75 mm	s 0,5	12



FESTA

ČETKA PLETENA

kaljena

Broj	specifikacija	Žice	
22025	Ø 75 mm	s 0,5	12

NEW



FESTA

ČETKA RADIJALNA, PLETENA

Broj	specifikacija	Žice	
21950	Ø 200 mm 25,4 mm		1



FESTA

ČETKA VALOVITA

mesing

Broj	specifikacija	Žice	
22030	Ø 65 mm	s 0,3	12
22031	Ø 75 mm	s 0,3	12



FESTA

ČETKA RADIJALNA, VALOVITA

mesing

Broj	specifikacija	Žice	
22026	Ø 50 mm	s 0,3	15
22027	Ø 63 mm	s 0,3	15
22028	Ø 75 mm	s 0,3	10
22029	Ø 100 mm	s 0,3	15



FESTA

ČETKA

Broj	specifikacija	Žice	
22058	Ø 12 mm	s 0,3	25
22059	Ø 25 mm	s 0,3	25



FESTA

ČETKA VALOVITA

mesing

Broj	specifikacija	Žice	
22018	Ø 12 mm	s 0,3	15
22019	Ø 17 mm	s 0,3	15
22020	Ø 25 mm	s 0,3	25



FESTA

ČETKA PLETENA

kaljena

Broj	specifikacija	Žice	
22021	Ø 19 mm	s 0,5	30
22022	Ø 22 mm	s 0,5	25



FESTA

ČETKA NYLON



Broj	specifikacija	Žice	
21940	Ø 75 mm M14	1,2 mm	1
21941	Ø 100 mm M14	1,2 mm	1



FESTA

ČETKA NYLON



Broj	specifikacija	Žice	
21930	Ø 125 mm M14	1,2 mm	10
21931	Ø 150 mm M14	1,2 mm	15

Ø 6 mm



FESTA

ČETKA NYLON



Broj	specifikacija	Žice	
22032	Ø 100 mm	1,2 mm	12

Ø 6 mm

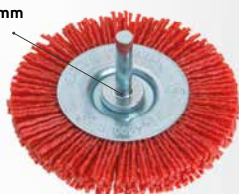

FESTA

ČETKA NYLON



Broj	specifikacija	Žice	
21935	Ø 50 mm	1,2 mm	1
21936	Ø 75 mm	1,2 mm	1
21937	Ø 100 mm	1,2 mm	1



Ø 6 mm

ČETKA NYLON



Broj	specifikacija	
22088	Ø 65 mm	9
22090	Ø 100 mm	5



ČETKA NYLON



Broj	specifikacija	
22083	Ø 115 mm Ø 22,2 mm	10
22084	Ø 125 mm Ø 22,2 mm	10
22085	Ø 150 mm Ø 22,2 mm	10



ČETKA NYLON



Broj	specifikacija	
22095	Ø 178 mm	1

NEW

FESTA

DIJAMANTNI KOTAČIĆ
BRUSNI
WITH VELCRO

- keramičke pločice
- staklo
- mramor
- granit



· držač 22043

Broj	specifikacija	oštrina	
24665	Ø 100 mm	● P60	10
24666	Ø 100 mm	● P120	10
24667	Ø 100 mm	● P200	10

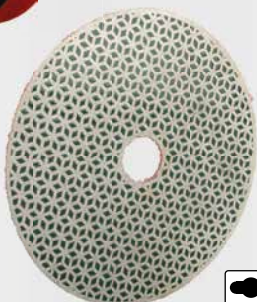

FESTA

DIJAMANTNI KOTAČIĆ
ZA POLIRANJE
Ø 100 MM,
WITH VELCRO

- keramičke pločice
- staklo
- mramor
- granit



· držač 22043

Broj	oštrina	
22701	50	1
22702	100	1
22703	200	1
22704	400	1
22705	800	1
22706	1500	1
22707	3000	1





VUNENA ČETKA ZA POLIRANJE



Broj	specifikacija	specifikacija	
22065	Ø 125 mm	na čičak	20
22066	Ø 150 mm	na čičak	20

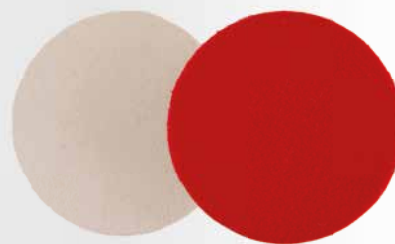

ČETKA ZA POLIRANJE



Broj	specifikacija	
22070	Ø 115 mm	20
22071	Ø 125 mm na čičak	20
22072	Ø 150 mm	20

FESTA

DRŽAČ BRUSNOG PAPIRA NA ČIČAK

- M14 | Ø 8 mm
- EVA 10 mm

M14



Broj	specifikacija	
22062	Ø 115 mm	25
22063	Ø 125 mm	25
22064	Ø 150 mm	10



FESTA

DRŽAČ FIBER DISKOVA



M14

Broj	specifikacija	
22073	Ø 125 mm, M14	1
22074	Ø 150 mm, M14	1



FESTA

DRŽAČ BRUSNOG PAPIRA

- Za kutnu brusilicu
- za 24665-24667, 22701-22707

M14



Broj	specifikacija	
22043	Ø 100 mm na čičak	1

Ø 8 mm



DRŽAČ BRUSNOG PAPIRA

- Za kutnu brusilicu

M14



Broj	specifikacija	
22044	Ø 125 mm M14 na čičak	15
22060	Ø 150 mm M14 na čičak	6



8 mm

ADAPTÉR

M14

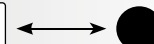

Broj	specifikacija	
22087		1



Ø 6 mm

BRUSNI NYLON KOTAČ

DRŽAČ BRUSNOG PAPIRA

Broj	specifikacija	
22061	Ø 125 mm na čičak	6

DRŽAČ BRUSNOG PAPIRA

Broj	specifikacija	
22041	Ø 125 mm učvršćivanje vijkom	11
22042	Ø 125 mm na čičak	11



Broj	specifikacija	
22091	Ø 50 mm P240	1
22092	Ø 75 mm P240	1
22093	Ø 100 mm P240	1

FESTA

FIBER DISC - Ø 125 MM

3x



Broj	oštrina	
22160	P40	1
22161	P60	1
22162	P80	1
22163	P100	1
22164	P120	1



FESTA

FIBER DISC - Ø 150 MM

3x



Broj	oštrina	
22167	P80	1



FESTA

BRUSNI PAPIR Ø125 MM, NA ČIČAK

3x



Broj	oštrina	
22045	P40	1
22046	P60	1
22047	P80	1
22048	P100	1
22049	P120	1
22050	P150	1
22051	P180	1
22052	P220	1

**FESTA**

BRUSNI PAPIR Ø150 MM, NA ČIČAK

3x



Broj	oštrina	
22053	P40	1
22054	P60	1
22055	P80	1
22056	P100	1
22057	P120	1

**FESTA**BRUSNI PAPIR OSA
94 X 94 X 94 MM

Broj	oštrina	
21831	P60	1
21832	P80	1
21834	P120	1

BRUSNI PAPIR, NA ČIČAK -
125 MM

3x

Broj	oštrina	
22096	P40	20
22097	P60	20
22098	P80	20
22099	P120	20

FESTABESKONAČNA TRAKA ZA
BRUŠENJE- 75 X 533 MM

3x



Broj	oštrina	
21810	P40	20
21811	P60	20
21812	P80	20
21813	P100	20
21814	P120	20



BRUSNI PAPIR 93 X 230 MM

5x

Broj	oštrina	broj rupa	
21740	P40	8	20
21741	P60	8	20
21742	P80	8	20
21743	P100	8	20
21744	P120	8	20



BRUSNI PAPIR 115 X 280 MM

5x

Broj	oštrina	broj rupa	
21750	P40	10	20
21751	P60	10	20
21752	P80	10	20
21753	P100	10	20
21754	P120	10	20

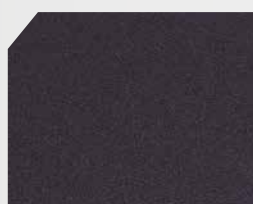

BRUSNO PLATNO 230 X 280 MM

10x

Broj	oštrina	
21732	P40	1
21734	P60	1
21735	P80	1
21736	P100	1
21737	P120	1

BRUSNI PAPIR VODOOTPORNI
230 X 280 MM

10x

Broj	oštrina	
21701	P60	1
21702	P80	1
21703	P100	1
21704	P120	1
21705	P150	1
21706	P180	1
21709	P240	1

BRUSNI PAPIR 230 X 280 MM

10x

Broj	oštrina	
21715	P40	1
21716	P60	1
21717	P80	1
21718	P100	1
21719	P120	1
21720	P150	1
21721	P180	1
21724	P240	1

NEW



FESTA

DRŽAČ BRUSNOG PAPIRA

· Ø 150 mm



Broj	specifikacija	
22119		1

FESTA

DRŽAČ BRUSNOG PAPIRA

· brzo stezanje



Broj	specifikacija	
22067	170 x 70 mm	10

DRŽAČ BRUSNOG PAPIRA



Broj	specifikacija	
22075	210 x 105 mm	100
22076	160 x 85 mm	100

DRŽAČ BRUSNOG PAPIRA



Broj	specifikacija	
22077	125 x 68 mm	10

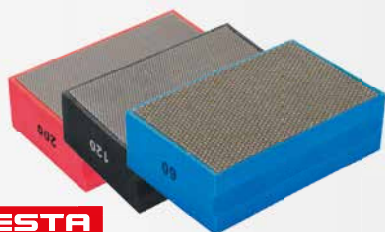

FESTA

DIJAMANTNA ABRAZIVNA SPUŽVICA

· 90 x 55 x 25 mm
· keramičke pločice
· staklo
· mramor
· granit



Broj	oštrina	
22115	P60	10
22116	P120	10
22117	P200	10

LAMEL DISK ZA BRUŠENJE

Broj	oštrina	specifikacija	
21850	P40		1
21851	P60		1
21852	P80	20 x 20, Ø 6 mm	1
21853	P100		1
21854	P120		1
21855	P40		1
21856	P60		1
21857	P80	30x30, Ø 6mm	1
21858	P100		1
21859	P120		1
21860	P40		1
21861	P60		1
21862	P80	60x30, Ø 6mm	1
21863	P100		1
21864	P120		1



FESTA

BRUSNA SPUŽVICA 100 X 70 X 28 MM - ZAKOŠENA



Broj	oštrina	
22106	P 60	10
22107	P 80	10
22108	P 100	10
22109	P 120	10



FESTA

BRUSNA SPUŽVICA 100 X 70 X 25 MM



Broj	oštrina	
22100	P60	20
22101	P80	20
22102	P100	20
22103	P120	20
22104	P180	20
22105	P220	20



FESTA

BRUSNA SPUŽVICA 120 X 95 X 10 MM



Broj	oštrina	
22110	P80	20
22111	P120	20
22112	P180	20
22113	P220	20

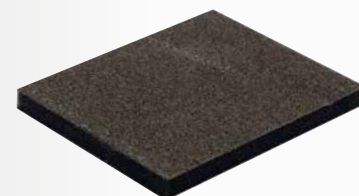

FESTA



Broj	specifikacija	Broj zuba	
Ø 115 mm			
22300	Ø 115 x 22 mm	40	1
Ø 125 mm			
22301	Ø 125 x 22 mm	40	1
Ø 140 mm			
22302	Ø 140 x 20 mm	24	1
22303	Ø 140 x 20 mm	30	1
Ø 150 mm			
22305	Ø 150 x 20 mm	24	1
Ø 160 mm			
22307	Ø 160 x 20 mm	18	1
22309	Ø 160 x 20 mm	24	1
22310	Ø 160 x 20 mm	30	1
22311	Ø 160 x 20 mm	36	1
22312	Ø 160 x 20 mm	48	1
22313	Ø 160 x 20 mm	60	1
Ø 165 mm			
22314	Ø 165 x 20 mm	24	1
Ø 180 mm			
22315	Ø 180 x 30 mm	24	1
22317	Ø 180 x 30 mm	50	1
22318	Ø 180 x 20 mm	50	1
Ø 185 mm			
22316	Ø 185 x 20 mm	24	1
Ø 190 mm			
22319	Ø 190 x 20 mm	40	1
22320	Ø 190 x 30 mm	40	1
Ø 200 mm			
22322	Ø 200 x 30 mm	24	1
22324	Ø 200 x 30 mm	40	1
22326	Ø 200 x 30 mm	60	1
Ø 205 mm			
22328	Ø 205 x 30 mm	40	1
22329	Ø 205 x 30 mm	60	1
Ø 210 mm			
22332	Ø 210 x 30 mm	40	1
22333	Ø 210 x 30 mm	60	1
Ø 250 mm			
22335	Ø 250 x 30 mm	40	1
22337	Ø 250 x 30 mm	60	1
Ø 300 mm			
22340	Ø 300 x 30 mm	40	1
22343	Ø 300 x 30 mm	60	1
22345	Ø 300 x 30 mm	96	1
Ø 350 mm			
22350	Ø 350 x 30 mm	40	1
22351	Ø 350 x 30 mm	54	1
Ø 400 mm			
22355	Ø 400 x 30 mm	40	1
22357	Ø 400 x 30 mm	60	1
Ø 500 mm			
22365	Ø 500 x 30 mm	60	1
Ø 600 mm			
22370	Ø 600 x 30 mm	60	1



FESTA

KRUŽNA PILA ZA CIRKULAR TCT

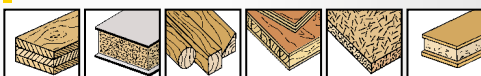

REDUKCIJSKI PRSTEN

Broj	specifikacija	
22399	Ø 20 16 mm	1
22398	Ø 30 25 mm	1

FESTA

SEŦ PRIBORA ZA OSCILIRAJUĆI VIŠENAMJENSKI ALAT

za 28045



4x

3x BI-METAL



1x SK5

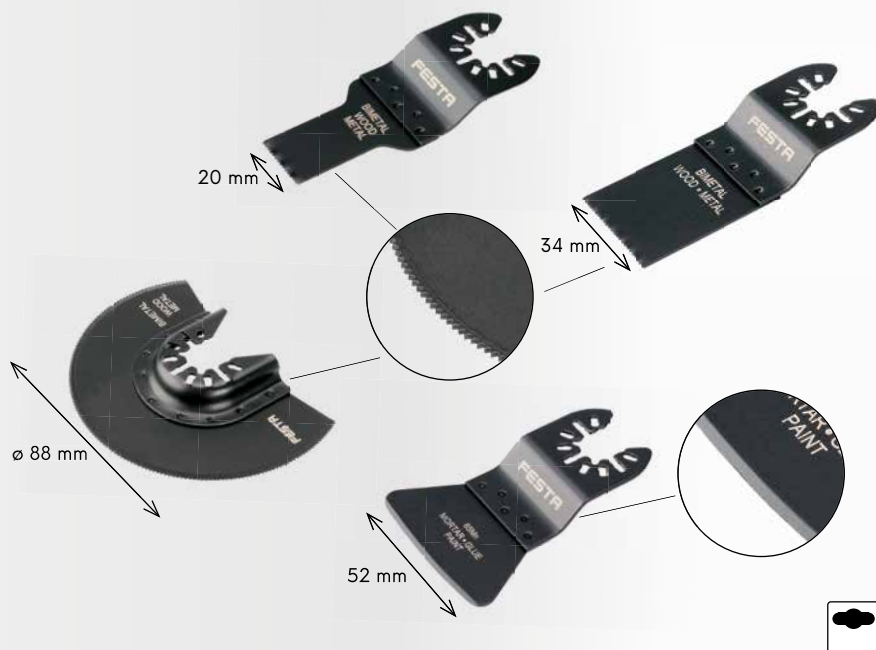

Broj specifikacija

24322

10

FESTA

SEŦ PRIBORA ZA OSCILIRAJUĆI VIŠENAMJENSKI ALAT

za 28045



4x

3x CARBIDE



1x

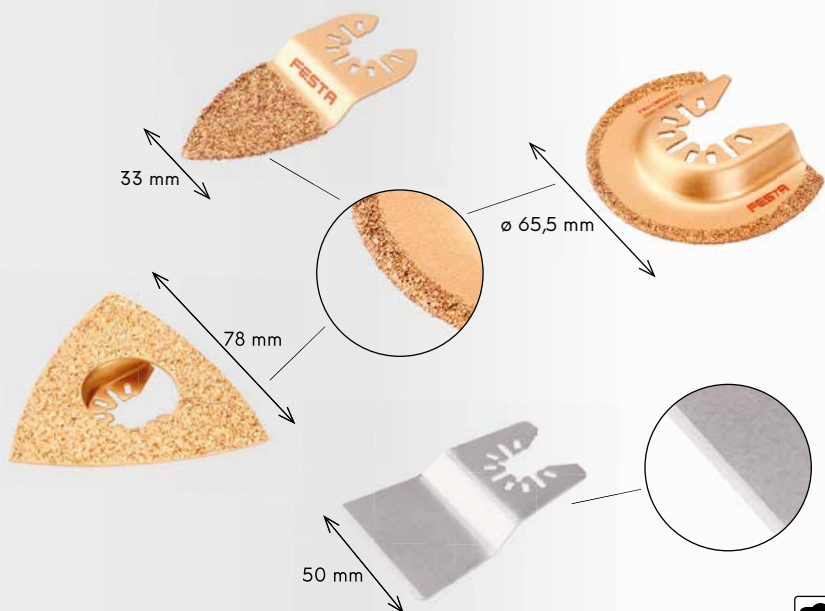

Broj specifikacija

24321

10

SEŦ PRIBORA ZA OSCILIRAJUĆI VIŠENAMJENSKI ALAT

za 28045



HCS 3x

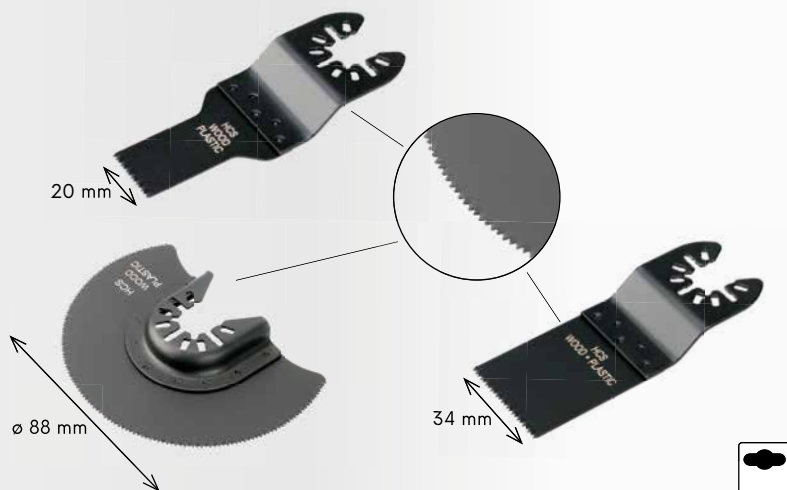

Broj specifikacija

24320

10

PROFI PILICE
PROIZVEDENE U NJEMAČKOJ PALJENJA LASEROM



LIST PILE UBODNE – PRIHVAT (AEG, BOSCH, FESTO, MAKITA, METABO)

	24060	50mm/1mm	0,7 mm/ 36TPI	31007	5 kom	10	
	24061	50mm/1mm	1,2 mm/ 21TPI	31012	5 kom	10	
	24062	50mm/1mm	2,0 mm/ 13TPI	31020	5 kom	10	
	24063	75mm/1mm	3,0 mm/ 8TPI	31030	5 kom	10	
	24064	100mm/1mm	1,2 mm/ 21TPI	31112	5 kom	10	
	24065	100mm/1,3mm	2,0 mm/ 13TPI	31112	5 kom	10	
	24066	75mm/1,45mm	2,0 mm/ 13TPI	31220	5 kom	10	
	24067	120mm/1,3mm	1,8 - 2,4 mm/ 10 - 14 TPI	31220	5 kom	10	
	24068	75mm/1,45mm	2,5 mm/ 10 TPI	32225	5 kom	10	
	24069	75mm/1,45mm	4 mm/ 6 TPI	32240	5 kom	10	
	24070	75mm/1,3mm	4 mm/ 6 TPI	32340	5 kom	10	
	24071	75mm/1,3mm	4 mm/ 6 TPI	32440	5 kom	10	
	24072	75mm/1,45mm	2,5 mm/ 10 TPI	32625	5 kom	10	
	24073	85mm/1,45mm	3 mm/ 8 TPI	32730	5 kom	10	
	24074	85mm/1,45mm	4 mm/ 6 TPI	32730	5 kom	10	
	24075	75mm/1,45mm	2,5 1,2 mm/10 21 TPI	32825	5 kom	10	
	24076	75mm/1,7mm	4 mm 6 TPI	32940	5 kom	10	
	24077	120mm/1,3mm	4 mm 6 TPI	32040	5 kom	10	
	24078	105mm/1,45mm	4 mm 6 TPI	34040	5 kom	10	
	24055	55mm	karbid		5 kom	1	

UBODNA PILA HSS – PRIHVAT ZA BLACK & DECKER (BLACK & DECKER, SKIL)

	24080	50mm 1,0 mm	1,2 21 TPI	11012	5 kom	10	
	24081	75mm 1,0 mm	3,0 8 TPI	11030	5 kom	10	
	24082	75mm 1,45 mm	2,5 10 TPI	12225	5 kom	10	
	24083	75mm 1,45 mm	4 6 TPI	12240	5 kom	10	
	24084	75mm 1,3 mm	4 6 TPI	12340	5 kom	10	
	24085	50mm 1,0 mm	2,0 13 TPI	12420	5 kom	10	
	24086	75mm 1,3 mm	4,0 6 TP	12440	5 kom	10	
	24087	75mm 1,45 mm	2,5 10 TPI	12625	5 kom	10	

	mekani čelik (sa malom količinom ugljika)		sendvič materijal		nehrđajući čelik		laminirano drvo
	metali bez željeza		tvrdno i mekano drvo		iverica		plastika
	šperploča		šperploča		drvo sa čavlima		
	sendvič materijal		plōčica		aluminij		

POLICA ZA LIST PILE UBODNE

- sadržaj kompleta 24098 - 24060 · 5 kom
 24080 · 5 kom
 24061 · 5 kom
 24062 · 5 kom
 24081 · 5 kom
 24063 · 5 kom
 24066 · 5 kom
 24067 · 5 kom
 24082 · 5 kom
 24068 · 5 kom
 24083 · 5 kom
 24069 · 5 kom
 24084 · 5 kom
 24070 · 5 kom
 24086 · 5 kom
 24071 · 5 kom
 24087 · 5 kom
 24072 · 5 kom
 24073 · 5 kom
 24074 · 5 kom
 24075 · 5 kom
 24076 · 5 kom



SET UBODNIH PILA



5x

Broj	specifikacija	
24045	set	50

Broj	specifikacija	
24099	64 x 50 cm - sadržaj bez kompleta	1
24098	64 x 50 cm - sadržaj kompleta	1

FESTA

LIST ZA SABLJASTU PILU

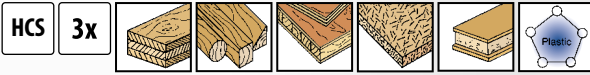

Broj	specifikacija		
24301	150 x 19 x 1,3 mm TPI 6		1

FESTA

LIST ZA SABLJASTU PILU

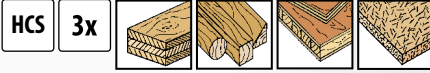

Broj	specifikacija		
24302	225 x 19 x 1,3 mm TPI 3		1

FESTA

LIST ZA SABLJASTU PILU

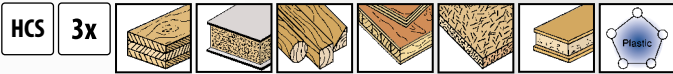

Broj	specifikacija		
24303	200 x 19 x 1,3 mm TPI 6 - 10		1

FESTA

LIST ZA SABLJASTU PILU

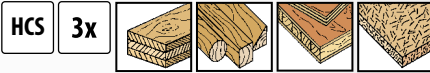

Broj	specifikacija		
24304	240 x 19 x 1,5 mm TPI 5		1

FESTA

LIST ZA SABLJASTU PILU

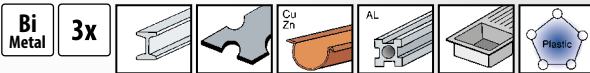

Broj	specifikacija		
24305	150 x 19 x 1 mm TPI 24		1

FESTA

LIST ZA SABLJASTU PILU

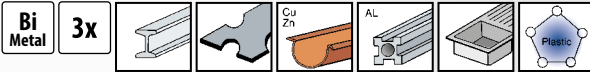

Broj	specifikacija		
24306	150 x 19 x 1 mm TPI 9		1

FESTA

LIST ZA SABLJASTU PILU



Broj	specifikacija		
24308	225 x 19 x 1 mm TPI 10 - 14		1

FESTA

LIST ZA SABLJASTU PILU



Broj	specifikacija		
24310	150 x 22 x 1,6 mm TPI 9		1

FESTA

LIST ZA SABLJASTU PILU



Broj	specifikacija	
24313	225 x 22 x 1,6 mm TPI 6	1

FESTA

METALNA PILA HS ZA INOX

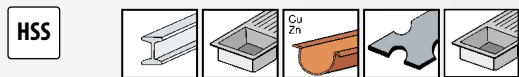

Broj	specifikacija	
24050	203 x 19 x 1 mm TPI 10 - 14	25

FESTA

LIST ZA SABLJASTU PILU

· Karbidna tehnologija

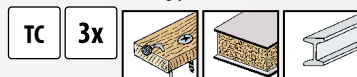

Broj	specifikacija	
24312	225 x 19 x 1,3 mm TPI 6 - 9	1

FESTA

LIST ZA SABLJASTU PILU



Broj	specifikacija	
24315	305 x 50 x 1,5 mm	1
24316	455 x 50 x 1,5 mm	25

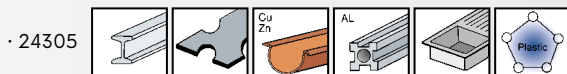

FESTA

LIST ZA SABLJASTU PILU



Broj	specifikacija	
24314		1

FESTA

DRŠKA ZA OŠTRICE PILE

· ručka + 2x list pile
· za oštrice klipne pile



Broj	specifikacija	
24325		1





FESTA
INDUSTRY



LIST PILE ZA DRVO

kaljeni zubi



Broj	specifikacija	
24185	533 mm	1
24186	610 mm	1
24187	760 mm	1
24188	800 mm	1
24189	914 mm	1

FESTA

LIST PILE ZA DRVO

kaljeni zubi



Broj	specifikacija	
24169	350 mm	10
24167	450 mm	10
24166	533 mm	10
24163	610 mm	10
24164	760 mm	10
24168	800 mm	10
24165	914 mm	10



PILA LIST



Broj	specifikacija	
24195	zub 3 mm 300 mm	1
24196	zub 4 mm 300 mm kosi zubi	1
24197	zub 5 mm 300 mm kaljeni zubi	1
24192	list pile za pilu za kosti 450 mm	1



PILA LIST

Broj	specifikacija	
24160	zub 3 mm 300 mm	20
24161	zub 4 mm 300 mm	20
24162	zub 5 mm 300 mm	50

PILA LIST

10x



Broj	specifikacija	
24108	6 mm 150 mm	1

REZNA STRUNA



Broj	specifikacija	
24120	300 mm	50



FESTA

PILA LIST BI - METAL

8 % COBALT



Broj	specifikacija	
24180	300 mm	125

FESTA

PILA LIST



Broj	specifikacija	
24109	12,5 mm 300 mm za željezo	144
24118	25 mm 300 mm za željezo obostrana	72
24119	25 mm 300 mm za željezo i drvo	72





96

SAVITLJIVI METAR



101

PREKLAPAJUĆI METAR



104

KUTOMJERI I KUTNICI



106

VODO-VAGA I
IZRAVNAVAJUĆA LETVA

112

LASERSKI MJERAČI



116

OLOVKA I TRAJNI MARKER



120

SPREJEVI



122

SKALPEL



137

KLJEŠTA ZA PVC CIJEVI



140

ODVIJAČI



146

BITOVI



154

KOMPLET NASADNIH
KLJUČEVA

159

NASADNI KLJUČ,
NASTAVCI, ADAPTERI

164

KLJUČEVI



169

KLIJEŠTA



179

ŠKARE ZA LJM,
TEHNIČKE ŠKARE

182

KLIJEŠTA ZA NITANJE



188

PILE I RAŠPE



190

PILE ZA METAL I DRVO



195

ČEKIĆI



203

STEZALJKE

ALATI

94 - 205



KOMELON®

· VISOKA PRECIZNOST I KVALITETNO MJERENJE

- II. klasa točnosti prema EEC 755345
- 10 x veća otpornost na brisanje mjerne trake najlonski površinski sloj DURA NY CoatTM

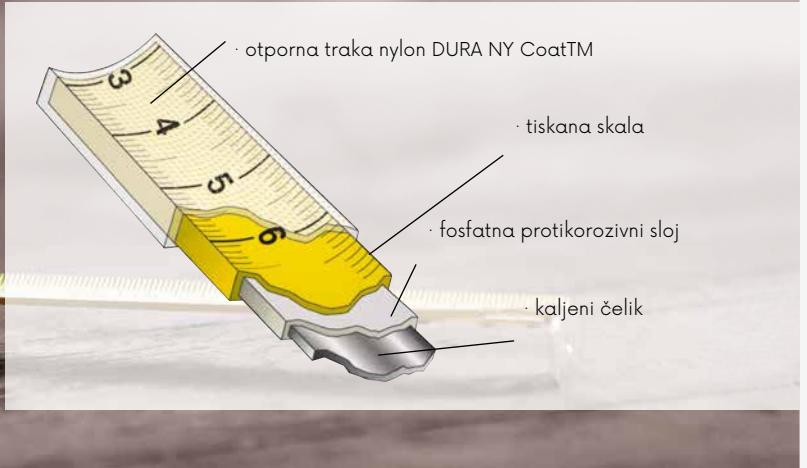

· Otporna na habanje najlona premazi DURA NY Coat™

KOMELON® SAVITLJIVI METAR

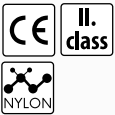

Broj	specifikacija	
10002	2 m · 16 mm	10
10003	3 m · 16 mm	10
10005	5 m · 19 mm	10
10008	8 m · 25 mm	10



· Otporna na habanje najlona premazi DURA NY Coat™

KOMELON® SAVITLJIVI METAR

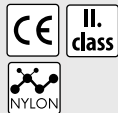

Broj	specifikacija	
10025	5 m · 25 mm	10



· Otporna na habanje najlona premazi DURA NY Coat™

KOMELON® SAVITLJIVI METAR

- automatska kočnica
- protuklizna guma

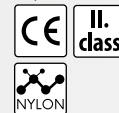

Broj	specifikacija	
10033	3 m · 16 mm	6
10035	5 m · 19 mm	6



KOMELON® SAVITLJIVI METAR



Broj	specifikacija	
10043	3 m · 16 mm	30
10045	5 m · 19 mm	30
10048	8 m · 25 mm	12



KOMELON® ČELIČNA TRAKA



Broj	specifikacija	
10110	10 m · 10 mm	6
10120	20 m · 10 mm	6
10130	30 m · 10 mm	6



KOMELON® STAKLOLAMINATNA TRAKA

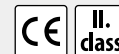

Broj	specifikacija	
10330	10 m · 13 mm	6
10332	20 m · 13 mm	6
10334	30 m · 13 mm	6
10336	50 m · 13 mm	6



KOMELON®

STAKLOLAMINATNA TRAKA



Broj	specifikacija	
10430	30 m · 13 mm	1
10450	50 m · 13 mm	1
10490	100 m · 13 mm	1



· primjer

PROMOTIVNI STALAK

Broj	specifikacija	
10998		1

KOMELON®

PROMOTIVNI STALAK ZA METRE

· stavke na stalaku 10996

10003	5 kom
10005	4 kom
10008	1 kom
10033	2 kom
10035	3 kom
10045	2 kom
10025	3 kom
10110	1 kom
10120	1 kom
10130	1 kom
10430	1 kom
10330	1 kom
10332	1 kom
10334	1 kom
10336	1 kom

· primjer



· primjer

Broj	specifikacija	
10999	stalak za metre i mjerne trake	1
10996	stalak ispunjen stavkama	1



· Informacije o mjerneoj traci



· dužina mjerne trake



· klasa točnosti



· izjava o sukladnosti - CE



· godina proizvodnje



· broj akreditiranog tijela za izdavanje certifikata



· proizvođač



· posebna prilagodba trake



· temperatura na kojoj je provedeno ispitivanje

FESTA



FESTA

SAVITLJIVI METAR

- skala s velikim brojevima
- protuklizna guma
- obloženo najlonom



Broj	specifikacija	
11353	3 m · 19 mm	12
11355	5 m · 19 mm	12
11356	5 m · 25 mm	12
11358	8 m · 25 mm	6
11360	10 m · 25 mm	6



FESTA

SAVITLJIVI METAR

- obloženo najlonom
- Abs kućište
- kromirani metalni isječak
- automatska kočnica
- protuklizna guma PTE
- plastična vezica



Broj	specifikacija	
11343	3 m · 16 mm	6
11345	5 m · 19 mm	6
11347	7,5 m · 25 mm	6



FESTA

SAVITLJIVI METAR - MAGNET

- 3 x trostruka kočnica
- magnetizirana kuka
- zaključavanje
- protuklizna guma



Broj	specifikacija	
11323	3 m · 19 mm	10
11325	5 m · 25 mm	10
11327	7,5 m · 25 mm	6



FESTA

SAVITLJIVI METAR - MAGNETIC

- magnetizirana kuka
- protuklizna guma
- fluorescentna traka
- skala s velikim brojevima



Broj	specifikacija	
11102	2 m · 16 mm	10
11103	3 m · 16 mm	10
11105	5 m · 19 mm	12
11106	5 m · 25 mm	12
11107	7,5 m · 25 mm	10
11110	10 m · 25 mm	6



FESTA

SAVITLJIVI METAR

- skala s velikim brojevima



Broj	specifikacija	
11226	2 m · 16 mm	10
11239	3 m · 19 mm	10
11259	5 m · 19 mm	12
11260	7,5 m · 25 mm	6



FESTA

SAVITLJIVI METAR

- automatska kočnica
- protuklizna guma



Broj	specifikacija	
11333	3 m · 16 mm	12
11335	5 m · 19 mm	12
11337	7,5 m · 25 mm	6
11338	10 m · 25 mm	6



FESTA

SAVITLJIVI METAR - COMPACT

- mala veličina mjerne vrpce
- obloženo najlonom



Broj	specifikacija	
11220	3 m · 16 mm	12
11221	5 m · 19 mm	12

**Johnney®****SAVITLJIVI METAR**

· matirana površina trake

II. class

Broj	specifikacija	
11002	2 m · 13 mm	12
11003	3 m · 13 mm	12
11005	5 m · 13 mm	12
11006	5 m · 19 mm	12
11007	7,5 m · 19 mm	12
11008	10 m · 25 mm	12

**SAVITLJIVI METAR - ERGO**· zaključavanje
· protuklizna guma

Broj	specifikacija	
11082	2 m · 16 mm	12
11083	3 m · 16 mm	12
11085	5 m · 19 mm	12

**SAVITLJIVI METAR**· metrička i inča ljestvica
· protuklizna guma

Broj	specifikacija	
11416	5 m · 19 mm	10

**SAVITLJIVI METAR**

· zaključavanje



Broj	specifikacija	
11200	2 m · 13 mm	24
11201	2 m · 16 mm	24
11202	2 m · 19 mm	24
11204	3 m · 13 mm	24
11205	3 m · 16 mm	24
11206	3 m · 19 mm	24
11207	5 m · 19 mm	12
11208	5 m · 25 mm	12
11209	7,5 m · 25 mm	12
11210	10 m · 25 mm	12

**SAVITLJIVI METAR S ISPISANIM IMENOM,
3M · 16 MM****CE II. class**

Č.p.	jméno na metru	Č.p.	jméno na metru	Č.p.	jméno na metru	Č.p.	jméno na metru
13500	JIŘÍ	13509	MIROSLAV	13518	VÁCLAV	13527	MISTR
13501	PETR	13510	BIG BOSS	13519	JAKUB	13528	ONDŘEJ
13502	JOSEF	13511	ZDENĚK	13520	LUKÁŠ	13529	MAREK
13503	TOMÁŠ	13512	MICHAL	13521	2X MĚŘ	13530	STANISLAV
13504	JAN	13513	MILAN	13522	LADISLAV	13531	BOREC
13505	MARTIN	13514	KAREL	13523	DAVID	13532	TATÍNEK
13506	JAROSLAV	13515	VLADIMÍR	13524	ROMAN	13533	ANTONÍN
13507	FRANTIŠEK	13516	DĚDEČEK	13525	ŠIKULA	13534	ALEŠ
13508	PAVEL	13517	MŮJ METR	13526	RADEK		



10

**FESTA****ČELIČNA TRAKA**

· omča

CE II. class

Broj	specifikacija	
12010	10 m · 10 mm	1
12020	20 m · 10 mm	1
12030	30 m · 10 mm	1
12050	50 m · 10 mm	6

**FESTA****STAKLOLAMINATNA TRAKA**

· omča

CE II. class

Broj	specifikacija	
12110	10 m · 13 mm	6
12120	20 m · 13 mm	1
12130	30 m · 13 mm	1
12150	50 m · 13 mm	1

**FESTA****ČELIČNA TRAKA**

· omča + kuka

CE II. class

Broj	specifikacija	
12220	20 m · 10 mm	6
12230	30 m · 10 mm	6
12250	50 m · 10 mm	6



FESTA

ČELIČNA TRAKA

· petlja



Broj	specifikacija	
12433	30 m · 12,5 mm	20
12435	50 m · 12,5 mm	10



MJERNI KOTAČ

- izdržljivo, mala težina i kompaktno
- brojač dodaje cm kada se kreće prema naprijed i oduzima cm dok se krećete unatrag
- ugrađena noćna rasvjeta, 2 AAA baterije u ručki
- torbica



Broj	specifikacija	
15989	max. 10 km	2



FESTA

TELESKOPSKA MJERNA ŠIPKA

· torbica

Broj	specifikacija	
15983	0,7 - 3 m	10
15985	1,1 - 5 m	10
15988	1,6 - 8 m	5



SAMOLJEPLJIVA MJERNA TRAKA



Broj	specifikacija	
11311	1 m · 12,5 mm	30
11312	2 m · 12,5 mm	30
11313	3 m · 16 mm	30
11314	5 m · 19 mm	30



SAVITLJIVI METAR PRIVJESAK

Broj	specifikacija	
11420	1 m · 6 mm narančasta	24



FESTA

SAVITLJIVI METAR PRIVJESAK

- skala s velikim brojevima
- svojstva klasične mjerne vrpce



Broj	specifikacija	
11410	2 m · 16 mm 6 boja	12



SAVITLJIVI METAR PRIVJESAK

Broj	specifikacija	
11444	1 m · 6 mm bijela	20



SAVITLJIVI METAR PRIVJESAK

Broj	specifikacija	
11425	1 m · 6 mm	25



LIBELA - PRIVJESAK

Broj	specifikacija	
11445		100

PREKLAPAJUĆI METAR



Broj	specifikacija	
13010	1 m · bijela	20
13020	2 m · bijela	10
13021	1 m · žuta	20
13022	2 m · žuta	10
13023	2 m · bijelo - žuti	10

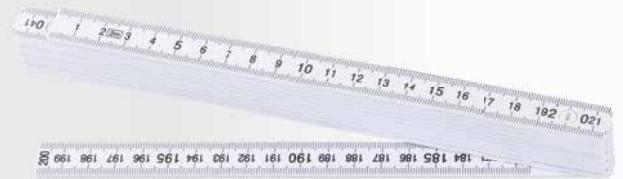
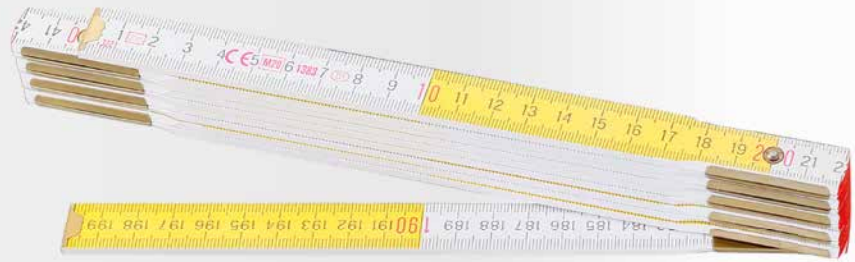

PREKLAPAJUĆI METAR



Broj	specifikacija	
13111	1 m · žuta	10
13120	2 m · žuta	5



PREKLAPAJUĆI METAR



Broj	specifikacija	
13211	1 m	1
13220	2 m	1

PREKLAPAJUĆI METAR S IMENOM



Broj	ime	Broj	ime	Broj	ime	
13401	JIŘÍ	13426	DANIEL			10
13402	JAN	13427	ANTONÍN	13451	JANA	
13403	PETR	13428	VOJTĚCH	13452	EVA	
13404	JOSEF	13429	FILIP	13453	PETRA	
13405	PAVEL	13430	ADAM	13454	MAJKA	
13406	MARTIN	13431	MILOSLAV	13455	HANA	
13407	JAROSLAV	13432	MATĚJ	13456	ANNA	
13408	TOMÁŠ	13433	ALEŠ	13457	LENKA	
13409	MIROSLAV	13434	JAROMÍR	13458	KATKA	
13410	ZDENĚK	13435	LIBOR	13459	LUCIE	
13411	FRANTIŠEK	13436	DOMINIK	13460	ALENA	
13412	VÁCLAV	13437	PATRIK	13461	VERONIKA	
13413	MICHAL	13438	VLASTIMIL	13462	MARTINA	
13414	MILAN	13439	JINDŘICH	13463	JITKA	
13415	KAREL	13440	MILOŠ	13464	BIG BOSS	
13416	JAKUB	13441	JÁN	13465	2 x MĚŘ	
13417	LUKÁŠ	13442	PETER	13466	TATÍNEK	
13418	DAVID	13443	ONDREJ	13467	DĚDEČEK	
13419	VLADIMÍR	13444	JOZEF	13468	ŠIKULA	
13420	LADISLAV	13445	PAVOL	13469	MISTR	
13421	ONDŘEJ	13446	L'UBOMÍR	13470	MACHR	
13422	ROMAN	13447	KAROL	13471	BOREC	
13423	STANISLAV	13448	RADOSLAV	13472	UŽ JE MŮJ	
13424	MAREK	13449	VOJTĚCH	13473	MŮJ METR	
13425	RADEK	13450	ZDENKO			

STALAK ZA PREKLAPAJUĆE METRE

stavke u postolju 13399

13401	· 15	kom
13402	· 15	kom
13403	· 15	kom
13404	· 15	kom
13405	· 15	kom
13406	· 15	kom
13412	· 15	kom
13413	· 15	kom
13414	· 15	kom
13415	· 15	kom
13416	· 15	kom
13417	· 15	kom
13418	· 15	kom
13419	· 15	kom
13420	· 15	kom
13421	· 10	kom
13422	· 10	kom
13423	· 10	kom
13424	· 10	kom
13425	· 10	kom
13426	· 10	kom
13427	· 10	kom
13428	· 10	kom
13429	· 10	kom
13430	· 10	kom
13431	· 10	kom
13432	· 10	kom
13433	· 10	kom
13434	· 10	kom
13435	· 10	kom
13436	· 10	kom
13437	· 10	kom
13438	· 10	kom
13439	· 10	kom
13440	· 10	kom



Broj	specifikacija	
13399	stalak ispunjen artiklima	1
13400	stalak bez artikla	1

**FESTA**

POMIČNO MJERILO DIGITALNO



INOX	Broj	specifikacija	
	14007	150 0,01 mm	10
	14008	200 0,01 mm	10
	14009	300 0,01 mm	10



POMIČNO MJERILO DIGITALNO

· preciznost 0.2 mm, rezolucija 0.1 mm

Broj	specifikacija	
14013	150 0,2 mm	10

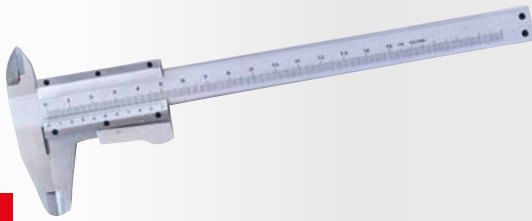
**FESTA**

POMIČNO MJERILO

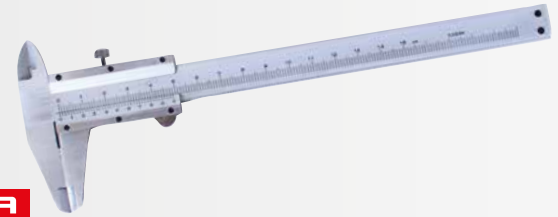

INOX	Broj	specifikacija	
	14004	150 0,02 mm	10

**FESTA**

POMIČNO MJERILO



INOX	Broj	specifikacija	
	14001	150 0,02 mm	10
	14002	200 0,02 mm	10
	14003	300 0,02 mm	10

**FESTA**

MIKROMETAR



Broj	specifikacija	
14040	0 - 0,25 0,01 mm	10
14045	25 - 50 0,01 mm	10



POMIČNO MJERILO PLASTIČNO

HOBBY

PLASTIC	Broj	specifikacija	
	14006	150 mm	50

**FESTA**

MJERILO ODSTUPANJA



INOX	Broj	specifikacija	
	14035	0 - 10mm 0,01 mm	10



MJERNI LISTIĆI

· 20 leaves



Broj	specifikacija	
14080	0,05 - 1 mm	10



ŠESTAR ZA OCRTAVANJE



Broj	specifikacija	
13285	200 mm	10

**FESTA**

CRTAĆA IGLA



Broj	specifikacija	
13281	150 mm	50

**FESTA**

CRTAĆA IGLA



Broj	specifikacija	
13282	200 mm	50

FESTA

RAVNALO S RUČKOM

ALU

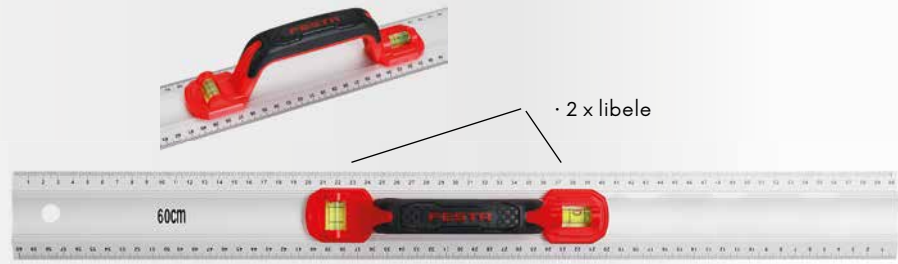

Broj	specifikacija	
14030	600 mm	6

**FESTA**

ALU MJERILO

ALU



Broj	specifikacija	
14015	400 mm	48
14017	600 mm	50
14019	1000 mm	40

**FESTA**

ČELIČNO MJERILO

INOX

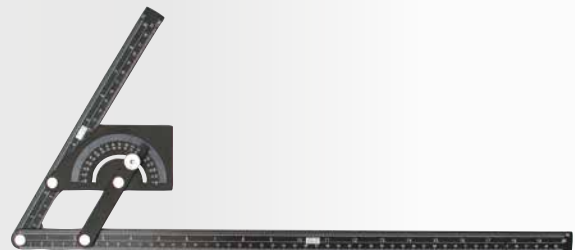
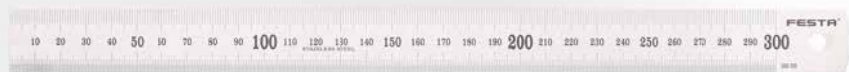

Broj	specifikacija	
14010	300 mm	10
14011	600 mm	10
14012	1000 mm	10

**FESTA**

KUTOMJER SA POMIČNIM RAMENOM

· torbica

Broj	specifikacija	
14060	0° - 180° · 150 x 200 mm	10
14070	0° - 180° · 300 x 500 mm	5

KUTOMJER

HOBBY

Broj	specifikacija	
14075	0° - 180° · 230 x 500 mm	30



VIŠENAMJENSKI KUTOMJER

No.	Specification
14077	



10

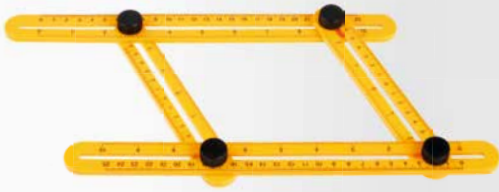

VIŠENAMJENSKI KUTOMJER



Broj	specifikacija	
14480	250 x 120 mm	1



• brava

PREDLOŽAK ZA KOPIRANJE OBLIKA



Broj	specifikacija	
14090	125 x 30 mm	1
14091	250 x 30 mm	1

FESTA

KUTNIK VIŠENAMJENSKI 3D



Broj	specifikacija	
14418		10



FESTA

KUTNIK VIŠENAMJENSKI



Broj	specifikacija	
14420	180 mm	10
14421	300 mm	10

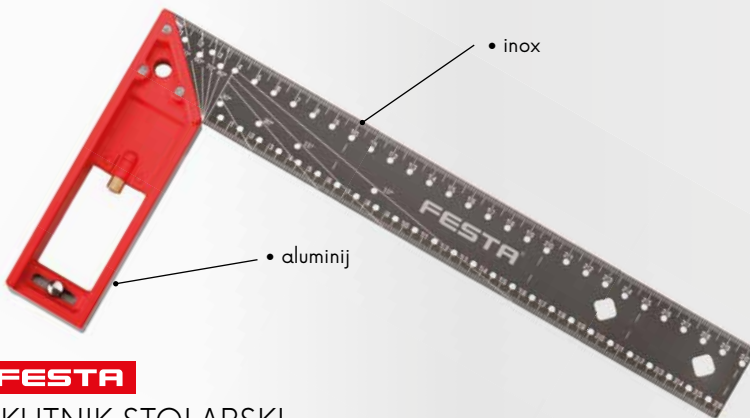

FESTA

KUTNIK STOLARSKI



No.	Specification	
14415	300 mm	6
14417	400 mm	6



FESTA

KUTNIK

ALU



Broj	specifikacija	
14445	600 x 600 mm	1
14446	1200 x 1200 mm	1

FESTA

KUTNIK

ALU

Broj	specifikacija	
14450	190 x 355 mm	6
14451	200 x 405 mm	6

FESTA

KUTNIK STOLARSKI

MADE IN EU

Broj	specifikacija	
14220	200 x 125 mm	10
14225	250 x 135 mm	10
14230	300 x 135 mm	10
14235	350 x 190 mm	10
14240	400 x 190 mm	10
14250	500 x 210 mm	10

FESTA

KUTNIK STOLARSKI

MADE IN EU

Broj	specifikacija	
14350	500 x 235 mm	10
14360	600 x 300 mm	10
14370	700 x 300 mm	10
14380	800 x 320 mm	10
14399	1000 x 360 mm	10

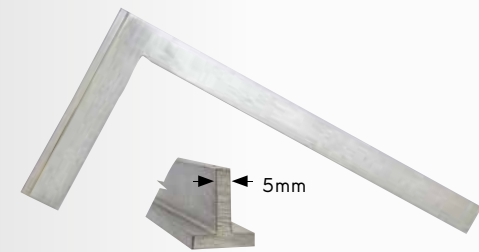
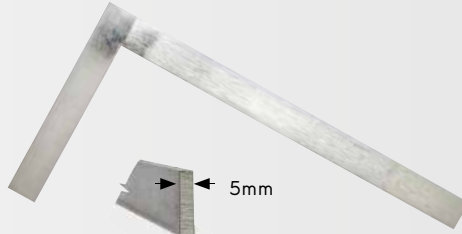

KUTNIK

Broj	specifikacija	
14410	300 x 200 mm	50
14411	600 x 400 mm	36

KUTNIK POCINČANI

Zn	Broj	specifikacija	
	14471	150 x 100 mm	25
	14472	250 x 125 mm	25
	14473	400 x 200 mm	30
	14474	600 x 300 mm	25

KUTNIK POCINČANI

Zn	Broj	specifikacija	
	14490	100 x 50 mm	10
	14491	150 x 75 mm	10
	14492	250 x 125 mm	10
	14493	400 x 200 mm	10
	14494	600 x 300 mm	10



KUTNIK

Broj	specifikacija	
14455	300 x 200 mm	50
14456	500 x 250 mm	50
14457	700 x 300 mm	40
14458	1000 x 450 mm	30

KUTNIK

ALU	HOBBY	Broj	specifikacija	
		14425	250 x 130 mm	12
		14430	300 x 130 mm	12
		14435	350 x 156 mm	12
		14440	400 x 156 mm	12

DRVENI KUTNIK

MADE IN EU	Broj	specifikacija	
	14025	255 x 285 mm	1

MADE IN EUROPE

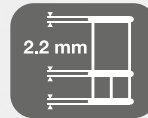
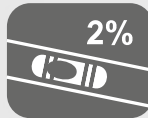
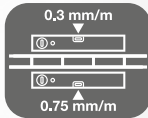

Svaki dio je elektronički testiran i ima svoj evidencijski broj, proizvođač posjeduje certifikat ISO 9001



HORIZONT
MASTER



HORIZONT

MASTER VODO-VAGA, 2 LIBELE

ALU

Broj	specifikacija
15033	60 cm



10



HORIZONT

MASTER VODO-VAGA, 3 LIBELE

ALU

Broj	specifikacija
15034	80 cm
15035	100 cm



10

10



HORIZONT

MASTER VODO-VAGA, 3 LIBELE, SA RUKOVAHTIMA

ALU

Broj	specifikacija
15036	120 cm
15037	150 cm
15039	200 cm



10

10

10

HORIZONT®

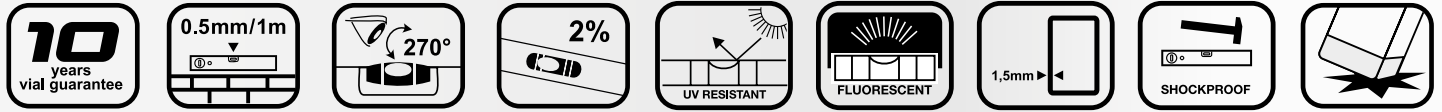

Svaki dio je elektronički testiran i ima svoj evidencijski broj, proizvođač posjeduje certifikat ISO 9001

HORIZONT® VODO-VAGA 2 LIBELE



Broj	specifikacija	
15003	30 cm	30
15004	40 cm	30
15005	50 cm	30
15006	60 cm	30
15008	80 cm	30
15010	100 cm	30
15012	120 cm	10
15015	150 cm	10
15018	180 cm	10
15020	200 cm	10



HORIZONT® VODO-VAGA 3 LIBELE



Broj	specifikacija	
15103	30 cm	30
15104	40 cm	30
15105	50 cm	30
15106	60 cm	30
15108	80 cm	30
15110	100 cm	30
15112	120 cm	10
15115	150 cm	10
15118	180 cm	10
15120	200 cm	10



HORIZONT® VODO-VAGA 2 LIBELE + MAGNET



Broj	specifikacija	
15204	40 cm	30
15205	50 cm	30
15206	60 cm	30
15208	80 cm	30
15210	100 cm	30
15212	120 cm	10
15215	150 cm	10
15218	180 cm	10
15220	200 cm	10



HORIZONT® NAGIBNA VODO-VAGA 4 LIBELE



Broj	specifikacija	
15230	80 cm	10



HORIZONT.

VODO VAGA SA KUTOMJEROM

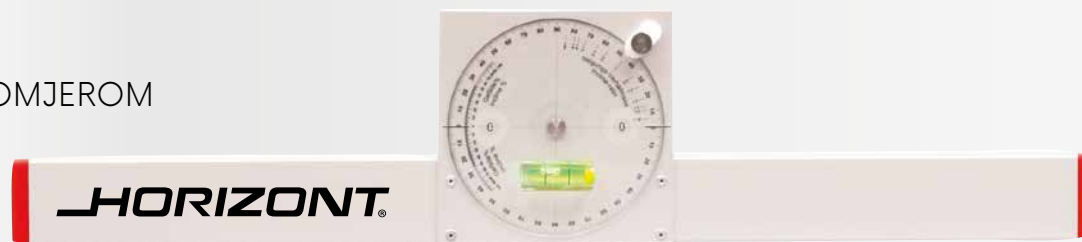

Broj	specifikacija	
15235	60 cm	1

**HORIZONT.**

IZRAVNAVAJUĆA LETVA

ALU

Broj	specifikacija	
15310	100 cm	10
15315	150 cm	10
15318	180 cm	10
15320	200 cm	10
15325	250 cm	10
15330	300 cm	10
15335	350 cm	10
15340	400 cm	10

**HORIZONT.**

IZRAVNAVAJUĆA LETVA, 1 LIBELA

ALU

Broj	specifikacija	
15415	150 cm	10
15418	180 cm	10
15420	200 cm	10
15425	250 cm	10
15430	300 cm	10

**HORIZONT.**

IZRAVNAVAJUĆA LETVA, 2 LIBELE

ALU

Broj	specifikacija	
15510	100 cm	10
15515	150 cm	10
15518	180 cm	10
15520	200 cm	10
15525	250 cm	10
15530	300 cm	10
15535	350 cm	10
15540	400 cm	5

**HORIZONT.**

IZRAVNAVAJUĆA LETVA SA RUKOVAHTIMA

ALU

Broj	specifikacija	
15615	150 cm	10
15620	200 cm	10
15625	250 cm	10
15630	300 cm	10



HORIZONT

IZRAVNAVAJUĆA LETVA, 2 LIB.+ 2 RUK

ALU

Broj	specifikacija	
15710	100 cm	10
15715	150 cm	10
15720	200 cm	10
15725	250 cm	10
15730	300 cm	10
15735	350 cm	10
15740	400 cm	5

**HORIZONT**

IZRAVNAVAJUĆA LETVA, TRAPEZ PROFIL

TRAPEZOIDNI PROFIL

- trapezoidni profil služi za finije obrade površine
- prikladan za štukaturu i fasade
- prikladan za tanko slojne žbuke

ALU	Broj	specifikacija	
	15810	100 cm	10
	15812	120 cm	10
	15815	150 cm	10
	15818	180 cm	10
	15820	200 cm	10
	15825	250 cm	10
	15830	300 cm	10

**HORIZONT**

IZRAVNAVAJUĆA LETVA, H PROFIL

PROFIL "h"

- „h“ profil služi za finije obrade površine
- prikladan za štukaturu i fasade
- prikladan za štukaturu stropnih žbuka

ALU	Broj	specifikacija	
	15850	100 cm	10
	15853	150 cm	10
	15855	180 cm	10
	15860	200 cm	10
	15870	250 cm	10
	15880	300 cm	10



NEW

HORIZONTSPOJNICA ZA
IZRAVNAVAJUĆE LETVE
HORIZONT

Broj	specifikacija		
15301		1	

**HORIZONT**IZRAVNAVAJUĆA LETVA,
1 LIBELA PODESIVA

Broj	specifikacija	
15893	65 - 100 cm	1
15894	95 - 150 cm	1
15895	145 - 235 cm	1

**HORIZONT**

KUTNIK

ALU	Broj	specifikacija	
	14485	800 x 1200 mm	1
	14486	1000 x 1500 mm	1



HORIZONT. REKLAMNI STALAK

· za vodo vage i letve 15998

15003	· 5 kom
15004	· 5 kom
15005	· 5 kom
15006	· 5 kom
15008	· 5 kom
15010	· 5 kom
15012	· 5 kom
15015	· 3 kom
15018	· 3 kom
15020	· 3 kom
15108	· 3 kom
15206	· 3 kom
15210	· 3 kom

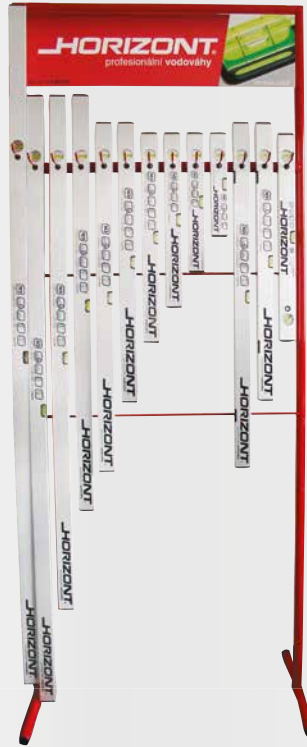

HORIZONT. REKLAMNI STALAK

· za vodo vage i letve 15996

15004	· 5 kom
15005	· 5 kom
15006	· 5 kom
15008	· 5 kom
15010	· 5 kom
15012	· 5 kom
15015	· 5 kom
15018	· 5 kom
15020	· 5 kom
15315	· 2 kom
15320	· 2 kom
15325	· 3 kom
15515	· 2 kom
15520	· 2 kom
15525	· 3 kom



Broj	specifikacija	
15999	85 x 210 x 50 cm	1
15998	85 x 210 x 50 cm napunjen	1

Broj	specifikacija	
15997	55 x 75 x 40 cm	1
15996	55 x 75 x 40 cm napunjen	1

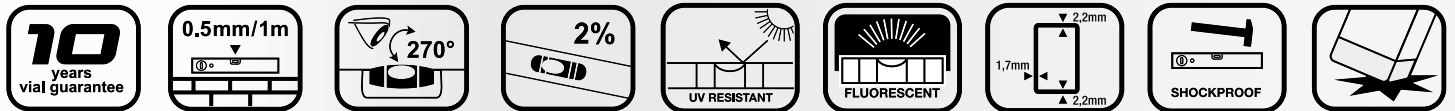

FESTA VODO-VAGA 3 LIBELE



Broj	specifikacija	
15754	400 mm	1
15756	600 mm	1
15758	800 mm	1
15760	1000 mm	1
15762	1200 mm	1
15768	1800 mm	1
15770	2000 mm	1



VODO-VAGA DUO LIBELA - 2 NIVELA

- točnost 0,5 mm | 1m
- UV stabilna tekućina libele
- krajevi sa gumom otporni na udarce
- debljina stijenke 1,2 m



Broj	specifikacija	
15904	40 cm	30
15906	60 cm	30
15908	80 cm	30
15910	100 cm	30
15912	120 cm	20
15915	150 cm	10
15920	200 cm	20



VODO-VAGA 3 LIBELE

ALU HOBBY

Broj	specifikacija	
15954	40 cm	60
15956	60 cm	60
15958	80 cm	60
15960	100 cm	30
15962	120 cm	30
15965	150 cm	30
15970	200 cm	30



LIBELA ZA LETVU I ŠIPKU



Broj	specifikacija	
15981		1



Broj	specifikacija	
15980	230 mm	1

VODO-VAGA TRIO LIBELA, MAGNET

LIBELA ZA ŠIPKU

- 3 libele, magneti, traka za učvršćivanje



Broj	specifikacija	
26028		12



VODO-VAGA CRIJEVASTA



Broj	specifikacija	
15992	staklena cjevčica-crijevo 10 m	1
15993	staklena cjevčica-crijevo 15 m	1
15990	staklena cjevčica	50
15991	plastična cjevčica	50



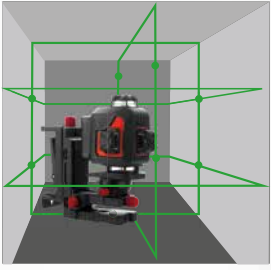

NEW

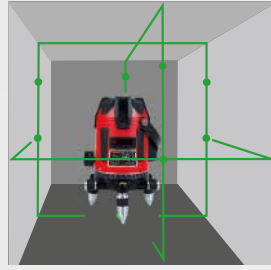

NEW



FESTA

LASER ALL LINE GREEN 4 X 360 °

- 2x vodoravna ravnina + 2x okomita ravnina (zelena zraka)
- područje samoniveliranja ±4°
- točnost 0,2 mm/m
- unutarnji: 30 m, vanjski s detektorom 50 m
- pulsni način rada – preporučeni dodatni prijemnik 26209
- uključeno: torba za nošenje, daljinski upravljač, laserska meta, Li-ion baterija 5200 mAh, profesionalni držač, mini tronožac, punjač

±4°	max. 50 m	±0.2 mm/m	II. class	515 nm
1/4"	5/8"	IP54	Li-ion 3.7V 5.2Ah	

Broj 26205 specifikacija 1



FESTA

CROSS-LINE GREEN LASER

- 1x vodoravna ravnina + 4x okomita ravnina (zelena zraka) + 1x točka
- područje samoniveliranja ±3°
- točnost 0,2 mm/m
- unutarnji: 20 m, vanjski s detektorom 50 m
- pulsni način rada – preporučeni dodatni prijemnik 26209
- uključeno: transportna torba, laserska meta, Li-ion baterija 5200 mAh, profesionalni držač, mini tronožac, punjač

±3°	max. 50 m	±0.2 mm/m	II. class	515 nm
5/8"	IP54	Li-ion 3.7V 5.2Ah		

Broj 26203 specifikacija 1



**FESTA****LASER ALL LINE GREEN 3 X 360°**

- 1x vodoravna ravnina + 2x okomita ravnina (zelena zraka)
- područje samoniveliranja $\pm 4^\circ$
- točnost 0,2 mm/m
- unutarnji: 30 m, vanjski s detektorom 50 m
- pulsni način rada – preporučeni dodatni prijemnik 26209
- uključeno: torba za nošenje, 4xAA alkalne baterije, laserska meta, naočale, 2600 mAh Li-ion baterija, profesionalni nosač, punjač, držač Li-ion baterije

$\pm 4^\circ$	INDOOR 30 m OUTDOOR 50 m	± 0.2 mm/m	II. class	515 nm
IP54	5/8"	1/4"	4x AA	Li-ion 7.4V 2.6Ah



Broj 26204
specifikacija green

1

**FESTA****CROSS-LINE GREEN LASER**

- 1x vodoravna ravnina + 1x okomita ravnina (zelena zraka)
- područje samoniveliranja $\pm 3^\circ$
- točnost 0,2 mm/m
- unutarnji: 20 m, vanjski s detektorom 50 m
- pulsni način rada – preporučeni dodatni prijemnik 26209
- uključeno: torba za nošenje, 2xAA alkalne baterije, nosač

$\pm 3^\circ$	INDOOR 20 m OUTDOOR 50 m	± 0.2 mm/m	II. class	515 nm
IP54	1/4"	2x AA		

Broj 26201
specifikacija green

1

FESTA**DALJINOMJER**

- mjerno područje 0,05 - 50 m
- točnost mjerenja ± 2 mm, mjerna jedinica mm/in/ft
- kontinuirano mjerenje, mjerenje površine, mjerenje volumena, mjerenje kraka trokuta, LCD FSTN, zbrajanje/oduzimanje, max./min. mjera uređaj, max pohrana 100 jedinica, pozadinsko osvjetljenje, klasa lasera 630-670 nm klasa 2
- radna temperatura 0 - 40°C
- veličina 112 x 50 x 25 mm, težina 90 g
- uključeno: torba za nošenje, 2xAAA alkalne baterije

max 50 m	± 2 mm	m in ft	630 670 nm
IP54	2x AAA		

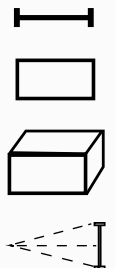

Broj 26211
specifikacija

1



FESTA

LASERSKI PRIJEMNIK

- za korištenje s pulsirajućim laserskim uređajima za povećanje dometa od 50 m
- uključeno: 9 V baterija, nosač
- za 26201, 26203, 26204, 26205

max 50 m	±1.5 mm 10 m	5 kHz	IP54	1x 9V
--------------------	------------------------	--------------	-------------	--------------



Broj	specifikacija	
26209	range: 50 m	1

1/4" + 5/8"



60 - 150 cm

TRONOŽAC

ALU



Broj	specifikacija	
26219	60 - 150 cm 1/4" + 5/8"	1

FESTA

DIGITALNI MJERAČ NAGIBA

- 0° - 360°
- preciznost ±0,1°
- rezolucija 0,1°
- funkcija automatskog isključivanja
- HOLD funkcija za zadržavanje izmjerene vrijednosti
- osvijetljen zaslon
- dimenzija 60x60x25 mm
- baterija 1xAAA



· bag

· magnetizirano dno

0.1°	LCD DISPLAY	1x AAA	0-50°C	82g
-------------	--------------------	---------------	---------------	------------



Broj	specifikacija	
26218		1



FESTA

DIGITALNI MJERAČ KUTA

200 mm	mm / inch	LCD DISPLAY	0°-360°
0.05°	+/- 0.2°	MANUAL LOCKING	1x CR2032 3V



Broj	specifikacija	
26217	200 mm	1



FESTA

DIGITALNI KUTNIK

- LCD zaslon
- mjerni raspon 0° - 225°
- razlika 0,1°
- točnost ± 0,3

ALU	0.1° LCD DISPLAY	3V LITHIUM
------------	----------------------------	-------------------



Broj	specifikacija	
26216	300 mm	1

FESTA**MULTIMETAR**

- Mjerenje istosmjernog napona: 200 mV - 300 V
- Mjerenje izmjeničnog napona: 200 mV - 300 V
- Mjerenje istosmjerne struje: 2000 μ A - 10 A
- mjerenje otpora: 200 Ω - 2 M Ω
- provjera baterije: 1,5 V, 9 V
- Indikacija niske baterije
- zaštita od preopterećenja

- IEC61010
- CATIII 300 V
- GS certifikat
- napajanje: baterija 9 V (6F22)
- dimenzije: 70x128x28 mm
- težina: 137 g (s baterijom)
- prilob: ispitni kablovi



Broj specifikacija
18429



1

**FESTA****ISPITIVAČ NAPONA**

- AC/DC - 6V, 12V, 24V, 50V, 120V, 230V, 400V
- otpornost na vodu IP54
- određivanje polariteta
- CAT III 400V



Broj specifikacija
18428



1

**Laserliner®****LUXTEST-MASTER**

- Mjerenje intenziteta svjetlosti na radnim mjestima, uredima, javnim zgradama i industriji
- Osjetljive foto diode s kosinjskom korekcijom za širok raspon mjerenja svjetlosti
- Relativne mjerne funkcije za referentno mjerenje i usporedbu
- Vrhunska funkcija za evidentiranje brzih promjena u razini osvijetljenja.
- Automatsko memoriranje funkcije.
- Automatsko i ručno mijenjanje dometa
- Promjenjiva funkcija : Lux (lm / m²), svjeće (lm / ft²)
- Min / maks. zaslon
- 1/4 " - navoj za postavljanje stativa



Broj specifikacija

Mjerni razmak: 20 Lux ... 200000 Lux

26520 Točnost: $\pm 3\%$ Frekvencijski razmak 2854 K

Kosinus odstupanje ugla: $\pm 2\%$ (30°), $\pm 6\%$ (60°)



1

specifikacija

Isporučuje se s: baterije, torbica

Laserliner®**AIRFLOWTEST-MASTER**

Profesionalni anemometar za mjerenje protoka zraka, volu metrijskog protoka i brzine vjetra

- Integrirani senzor za mjerenje temperature okoline, relativne vlage i točke rošnja
- USB sučelje za pohranjivanje izmjerenih podataka
- PC softver - Veliki rotor: 65 mm.
- Min. / Maks. zaslon.
- 1/4 "navoj za spajanje stativa prilikom dugogodišnjeg mjerenjem
- Osvijetljen, jasan zaslon s trajno vidljivim vrijednostima temperature okoline i relativne vlage



Broj specifikacija

Protok: 0.80...30 m | s | $\pm 2\%$

Sobna temperatura: -10...60 °C | $\pm 1.5^\circ$ C

26521 Relativna vlažnost: 20%...80% | $\pm 3\%$

Protok zraka: 0...99990 CMM



ZAPIS PODATAKA NA RAČUNALO

Isporučuje se s: PC softver, USB kabel, baterije, torba za nošenje



1

specifikacija



FESTA

OLOVKA HB



MOQ
12

Broj	specifikacija	MOQ
13270	HB · 180 mm	96
13271	HB · 180 mm · komplet 3 kom	32
13265	HB · 250 mm	96



FESTA

OLOVKA HB



MOQ
50

Broj	specifikacija	MOQ
13269	HB · 180 mm	50
13266	HB · 250 mm	50



FESTA

OLOVKA HB



MOQ
12

Broj	specifikacija	MOQ
13272	HB · 250 mm	96
13264	HB · 250 mm · bez ispisa	96



FESTA

OLOVKA HB



MOQ
50

Broj	specifikacija	MOQ
13268	250 mm	50



FESTA

TROKUTASTA OLOVKA HB

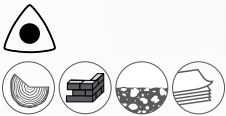

MOQ
12

Broj	specifikacija	MOQ
13278	250 mm	96



FESTA

OLOVKA 6H

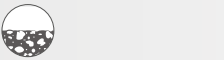

MOQ
12

Broj	specifikacija	MOQ
13275	6H · 250 mm	96



FESTA

OLOVKA ZA STAKO I KERAMIKU



MOQ
12

Broj	specifikacija	MOQ
13273	175mm crvena olovka – staklo, keramika	144



FESTA

OLOVKA

Broj	specifikacija	MOQ
13274	175 mm, crveno plavo	96



OLOVKA HB



MOQ
12

Broj	specifikacija	
13280	180 mm	96



OLOVKA SA CRVENIM GRAFITOM

Broj	specifikacija	
13276	175 mm	144



· brusni papir

ŠILJILO



Broj		
13261		12



FESTA

ČELIČNA OLOVKA SA GRAFITNIM ULOŠKOM HB

· rezervni grafit 13263, 13267



Broj	specifikacija	
13288		20



FESTA

ČELIČNA OLOVKA SA GRAFITNIM ULOŠKOM HB

· rezervni grafit 13263, 13267

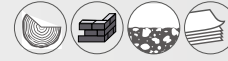

Broj	specifikacija	
13262	150 mm	20



FESTA

OLOVKA S ZAMJENJIVIM GRAFITOM



Broj	specifikacija	
13279	olovka + rezervni grafit HB	24
13284	rezervni grafit 5 kom	20



FESTA

REZERVNI GRAFIT U BOJI

· za 13262, 13288



Č.p.	Specifikace	
13267	● 2x žuta ● 2x Crvena ● 2x plava	1



FESTA

REZERVNI GRAFIT HB

· za 13262, 13288



Č.p.	Specifikace	
13263	● 6x crno	20



FESTA
 INDUSTRY

TRAJNI MARKER

Broj	specifikacija	
13200	○ bijel	1
13201	● crni	1
13202	● crveni	1

NEW

TRAJNI MARKER

- extra jak vrh
- Za označavanje čak i na masnim i mokrim površinama



Broj	specifikacija	
13216	crvena	12
13217	crna	12
13218	plava	12
13219	zelena	12

TRAJNI MARKER

- 2 vrste vrha markera
- Za označavanje čak i na masnim i mokrim površinama



Broj	specifikacija	
13227	bijela	ALU tube 40
13222	bijela	PVC tube 12
13228	crvena	ALU tube 40
13229	crna	ALU tube 40
13230	plava	ALU tube 12
13231	zelena	ALU tube 12

TRAJNI MARKER

Broj	specifikacija	
13214	bijela	12
13225	crvena	12
13226	crna	12
13223	plava	12
13224	zelena	12

TRAJNI MARKER

Broj	specifikacija	
13235	crvena	12
13236	crna	12
13237	plava	12
13238	zelena	12



FESTA

TRAJNI MARKER



Č.p.	Specifikacije	
13246	● crni	1
13247	● crveni	1
13248	○ bijel	1



DVOSTRANI TRAJNI MARKER - RAZLIČITE DEBLJINE

MOQ
12



Broj	Specifikacija	
13206	○ bijel	12



DVOSTRANI TRAJNI MARKER - RAZLIČITE DEBLJINE

MOQ
12



Broj	specifikacija	
13212	crni	12



DVOSTRANI TRAJNI MARKER - RAZLIČITE DEBLJINE

MOQ
12



Broj	Specifikacija	
13207	● crvena	12
13208	● plava	12



TRAJNI MARKER MINI



· 9 cm

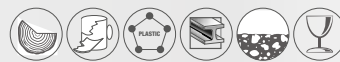

MOQ
72



Broj	specifikacija	
13205	● ● ● ● ●	72



FESTA

**VOŠTANE OLOVKE
KOMPLET 5 KOM**

· Ø 13 x 110 mm

5x



Broj	specifikacija	
13240	5 boja	20
13241	crvena	20
13242	crna	20

Broj	specifikacija	
13243	žuta	20
13244	zelena	20
13245	bijela	20



**POKRETNI
DRŽAČ SPREJA**

· Za SPREJEVI Trackmarker a Fluor



Broj	specifikacija	
13296		1



**VOŠTANE OLOVKE
KOMPLET 6 KOM**

6x



Broj	specifikacija	
13277		88



BIJELA KREDA

12x



Broj	specifikacija	
13260	12 x 12 x 80 mm	46



DRŽAČ SPREJA U OBLIKU PIŠTOLJA

· Za SPREJEVI Trackmarker a Fluor



Broj	specifikacija	
13295		1



SPREJ FLUORESCENTNO TRACKMARKER 500 ML

- Visoka vidljivost zbog fluorescentnog pigmenta
- Sigurnosna kapica
- Brzo sušenje 10 min.
- Trajnost 3 mjeseci
- Primjena - beton, asfalt, trava, šljunak, pijesak, kamen, drvo



Broj	specifikacija	
13250	● žuti	12
13251	● crveni	12
13252	● narančasta	12
13253	● zeleni	12
13254	● ružičasta	12
13249	● plava	12



SPREJ FLUORESCENTNO MARK 6M FLUO 500 ML

- Visoka vidljivost zbog fluorescentnog pigmenta
- Sigurnosna kapica
- Brzo sušenje 10 min.
- Trajnost 6 mjeseci
- Primjena - beton, asfalt, trava, šljunak, pijesak, kamen, drvo



Broj	specifikacija	
13360	● žuti	12
13361	● crveni	12
13362	● narančasta	12
13363	● zeleni	12
13364	● ružičasta	12
13365	○ bijela	12



SPREJ FLUORESCENTNO FLUO 500 ML

- Visoka vidljivost zbog fluorescentnog pigmenta
- Sigurnosna kapica
- Brzo sušenje 10 min.
- Trajnost 12 mjeseci
- Primjena - beton, asfalt, trava, šljunak, pijesak, kamen, drvo



Broj	specifikacija	
13350	● žuti	12
13351	● crveni	12
13352	● narančasta	12
13353	● zeleni	12
13354	● ružičasta	12
13355	○ bijela	12



SPREJ FLUORESCENTNO IDEAL 500 ML

- Visoka vidljivost zbog fluorescentnog pigmenta
- Sigurnosna kapica
- Brzo sušenje 10 min.
- Trajnost 12 mjeseci
- Primjena - beton, asfalt, trava, šljunak, pijesak, kamen, drvo



Broj	specifikacija	
13255	● žuti	12
13256	● crveni	12
13257	● narančasta	12
13258	● zeleni	12
13259	● ružičasta	12



KDS®

Visokokvalitetni skalpeli Japanese KDS

- izvrsna ergonomska drška
- visokokvalitetne i dugotrajne oštrice
- najbolji korišteni materijali u izradi
- mali otpor rezanja omogućuje lagano rezanje

**KDS®**
SKALPEL

Broj	specifikacija		
16002	LC405 18 mm zeleni	25	
16011	LB10 rezervno sječivo	10	

**KDS®**
SKALPEL

Broj	specifikacija		
16003	G11 18 mm + 2 sječivo	10	
16012	GB10 rezervno sječivo	10	

**KDS®**
SKALPEL

Broj	specifikacija		
16019	L19 18 mm + 2 sječivo	10	
16011	LB10 rezervno sječivo	10	
16012	GB10 rezervno sječivo	10	

**KDS®**
SKALPEL

Broj	specifikacija		
16004	H11 25 mm	10	
16013	HB10 rezervno sječivo	10	

**KDS®**
SKALPEL

Broj	specifikacija		
16005	S14 9 mm + 2 sječivo	10	
16010	SB10 rezervno sječivo	10	

**KDS®**
SKALPEL

Broj	specifikacija		
16006	D12 + 16 sječivo	10	

KDS®

REZERVNO SJEČIVO KDS

10x

Broj	specifikacija		
16010	SB10 9 0,38 mm	13 segmenata	20
16011	LB10 18 0,5 mm	15 segmenata	20
16012	GB10 18 0,6 mm	15 segmenata	20
16013	HB10 25 0,7 mm	7 segmenata	10

**KDS®**

REZERVNO SJEČIVO KDS

- specijalna legura
- duplo brušenje
- produžen vijek trajanja
- mali otpor rezanja omogućuje lagano rezanje

10x

Broj	specifikacija		
16016	LB10B 18 0,5 mm	8 segmenata	20
16017	HB10B 25 0,7 mm	7 segmenata	10

**KDS®**

REKLAMNI STALAK

Broj	specifikacija		
16999	reklamni stalak	1	
16998	ispunjen stalak s predmetima	1	



- stavke u postolju 16998 : 16001 · 5kom
- 16003 · 5kom
- 16004 · 3kom
- 16005 · 3kom
- 16006 · 2kom
- 16008 · 3kom
- 16010 · 4kom
- 16012 · 4kom
- 16013 · 1kom
- 16016 · 4kom
- 16018 · 4kom
- 16019 · 4kom
- 16020 · 4kom

· ilustrativna fotografija



FESTA



sustav za lomljenje oštrica



SKALPEL

· protu klizna guma



Broj	specifikacija	
16099	18 mm	12

FESTO



**SKALPEL
KERAMIČKA OŠTRICA**

- 3x oštrija od čelične oštrice
- 10x duži vijek trajanja
- vatrootalni, nevodljivi, nemagnetski



Broj	specifikacija	
16131	18 mm	10
16066	rezervno sječivo 18 mm, 5 kom	10



SKALPEL



Broj	specifikacija	
16110	L11 18 mm + 1 sječivo	12



SKALPEL



Broj	specifikacija	
16100	L12 18 mm + 1 sječivo	12



SKALPEL



Broj	specifikacija	
16105	L17 18 mm + 1 sječivo	12



SKALPEL



Broj	specifikacija	
16125	L4 9 mm	24
16120	L8 18 mm	24



SKALPEL



Broj	specifikacija	
16115	L10 9 mm	24

**FESTA**

SKALPEL

ALU



Broj	specifikacija	
16150	18 mm	24
16151	18 mm bez logotipa FESTA	20

**FESTA**

SKALPEL

ALU



Broj	specifikacija	
16136	18 mm	12

**FESTA**

SKALPEL

ALU



Broj	specifikacija	
16137	25 mm	12

**FESTA**

SKALPEL

· protu klizna guma



ALU



Broj	specifikacija	
16090	18 mm	12

**FESTA**

SKALPEL

· protu klizna guma



ALU



Broj	specifikacija	
16091	25 mm	6

**FESTA**

SKALPEL

· protu klizna guma

ALU



Broj	specifikacija	
16145	L25 18 mm	12

**FESTA**

SKALPEL

· protu klizna guma

ALU



Broj	specifikacija	
16144	L24 18 mm	12



SKALPEL

ALU



Broj	specifikacija	
16143	18 mm	12



SKALPEL

ALU



Broj	specifikacija	
16142	18 mm	12



SKALPEL

ALU



Broj	specifikacija	
16025	18 mm	12

**FESTA**

SKALPEL

ALU



Broj	specifikacija	
16029	18 mm	25

**FESTA**

SKALPEL

· protu klizna guma



Broj	specifikacija	
16146	18 mm	12



FESTA

SKALPEL

· protu klizna guma



Broj	specifikacija	
16147	25 mm	12



FESTA

SKALPEL

· protu klizna guma



Broj	specifikacija	
16130	L18 18 mm + 5 sječivo	12



FESTA

SKALPEL

· protu klizna guma



Broj	specifikacija	
16135	L20 25 mm + 5 sječivo	6



FESTA

SKALPEL

· protu klizna guma



Broj	specifikacija	
16140	L22 18 mm	12



FESTA

SKALPEL

· protu klizna guma



Broj	specifikacija	
16034	25 mm	12



FESTA

SKALPEL



Broj	specifikacija	
16085	9 mm	24



FESTA

SKALPEL

INOX



Broj	specifikacija	
16086	18 mm	24



SIGURNOSNI NOŽ

Broj	specifikacija	
16044		20



SIGURNOSNI NOŽ

· samovlačna ostrza

Broj	specifikacija	
16057	135 mm	12



FESTA

SIGURNOSNI NOŽ

ALU INOX



Broj	specifikacija	
16058		6
16074	rezervno sječivo 10 kom	1

16074



NEW



FESTO

SKALPEL

+2 SK4



Broj	specifikacija	
16039		6
16087	Rezervno sječivo	1



FESTO

SKALPEL TURBO

+5 ALU



Broj	specifikacija	
16037	+ 5 sječivo	6

FESTO

SKALPEL

+5 ALU



Broj	specifikacija	
16023	Skalpel+ 5 sječivo	12
16071	Rezervno sječivo 10 kom	10

FESTO

KOMPLET SKALPELA

ALU

Broj	specifikacija	
16095	25 sječivo	1



SKALPELI

22x



Broj	specifikacija	
16282		24



SKALPELI

13x



Broj	specifikacija	
16281		10



FESTO

SKALPEL SA ARETACIJOM

protu klizna guma

ALU +2



Broj	specifikacija	
16035	Skalpel + 2 rezervna sječiva	12



FESTO

SKALPEL SA ARETACIJOM

ALU +3



Broj	specifikacija	
16033	NP 110 + 3 rezervna sječiva	5





SKALPEL SA ARETACIJOM

ALU		
Broj	specifikacija	
16032	NP 109	48



SKALPEL SA ARETACIJOM

ALU		
Broj	specifikacija	
16031	NS 107 B	24



SKALPEL

ALU		
Broj	specifikacija	
16030	NS 107	24



SKALPEL

ALU		
Broj	specifikacija	
16046	18 mm	12



SKALPEL

ALU		
Broj	specifikacija	
16028	S 201 18 mm	24



SKALPEL

ALU		
Broj	specifikacija	
16026	P 205 18 mm	30



SKALPEL

HOBBY		
Broj	specifikacija	
16021	P 201 9 mm	60



SKALPEL

HOBBY		
Broj	specifikacija	
16024	P 204 18 mm	60



SKALPEL

ALU		
Broj	specifikacija	
16141	18 mm	24

MOQ
24

· protu klizna guma



KOMPLET SKALPELA

HOBBY	12x	
Broj	specifikacija	
16053	9 mm	12
16055	18 mm	12



KOMPLET SKALPELA

HOBBY	3x	
Broj	specifikacija	
16043		24



NOŽ ZA TEPIH I LINOLEUM

za tepih i lino

Broj	specifikacija	
16036	45 mm	12



KUKASTI NOŽ

za tepih i lino

Broj	specifikacija	
16041		12



50 mm

PRODUŽENI STRUGAČ STAKLA

ALU

Broj	specifikacija	
16059	50 mm	10
16082	sječivo	1



100 mm

PRODUŽENI STRUGAČ STAKLA

za korištenje s oštricama od 18 mm za noževe za lomljenje

ALU

Broj	specifikacija	
16054	100 mm	1



100 mm

PRODUŽENI STRUGAČ STAKLA

Broj	specifikacija	
16052	48 cm duljina	6
16070	sječivo	25



38 mm

FESTA STRUGALICA

protu klizna guma

Broj	specifikacija	
16049		12
16069	rezervno sječivo	1



60 mm

STRUGALICA

Broj	specifikacija	
16051		24



55 mm

STRUGALICA

Broj	specifikacija	
16050		24



SET STRUGALICA ZA PRIMJENU I UKLANJANJE SILIKONA

3x

Broj	specifikacija	
16042		12





FESTA

REZERVNO SJEČIVO

- 7 segmenata
- 3x duži vijek trajanja
- dvostruko brušenje
- mali otpor rezanja



Broj	specifikacija	
16064	25 0,7 mm	20

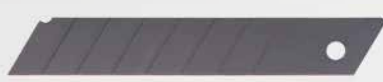

FESTA

REZERVNO SJEČIVO

- 8 segmenata
- 3x duži vijek trajanja
- dvostruko brušenje
- mali otpor rezanja



Broj	specifikacija	
16062	18 0,7 mm	10



FESTA

REZERVNO SJEČIVO

- 15 segmenata
- 3x duži vijek trajanja
- dvostruko brušenje
- mali otpor rezanja

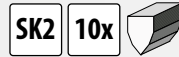

Broj	specifikacija	
16063	18 0,7 mm	10



FESTA

REZERVNA KERAMIČKA OŠTRICA

- 8 segmenata
- 3x oštija od čelične oštrice
- 10x duži vijek trajanja
- vatrostalni, nevodljivi, nemagnetski



Broj	specifikacija	
16066	18 0,6 mm	10



REZERVNO SJEČIVO

- 8 segmenata
- dvostruko brušenje



Broj	specifikacija	
16078	18 0,5 mm	25



REZERVNO SJEČIVO

- 8 segmenata
- dvostruko brušenje



Broj	specifikacija	
16077	18 0,6 mm	25



REZERVNO SJEČIVO

- 7 segmenata



Broj	specifikacija	
16068	25 0,6 mm	20



REZERVNO SJEČIVO

- 8 segmenata



Broj	specifikacija	
16065	18 0,5 mm	60



REZERVNO SJEČIVO

- 15 segmenata



Broj	specifikacija	
16081	18 0,5 mm	60



REZERVNO SJEČIVO

- 4 segmenata



Broj	specifikacija	
16067	18 0,5 mm	10



REZERVNO SJEČIVO

- 7 segmenata



Broj	specifikacija	
16061	9 0,4 mm	60

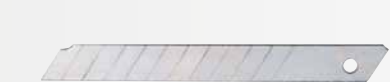

REZERVNO SJEČIVO

- 13 segmenata



Broj	specifikacija	
16060	9 0,45 mm	10

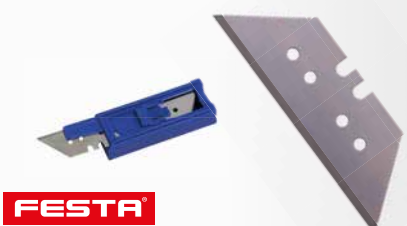

FESTA

REZERVNO SJEČIVO



Broj	specifikacija	
16072	R 004	10



FESTA

REZERVNO SJEČIVO



Broj	specifikacija	
16075	R 003	10



REZERVNO SJEČIVO



Broj	specifikacija	
16071	R 001	60



REZERVNO SJEČIVO

5x

Broj	specifikacija	
16083	18 mm	50



REZERVNO SJEČIVO

10x

Broj	specifikacija	
16073	R 002	60



REZERVNO SJEČIVO

5x

Broj	specifikacija	
16084	18 mm	50

FESTA

REZERVNO SJEČIVO

· za 16058

10x

Broj	specifikacija	
16074		1



REZERVNO SJEČIVO

· za 34315

Broj	specifikacija	
34316		1



REZERVNO SJEČIVO

· za 16052

Broj	specifikacija	
16070	100 mm	25

**FESTA**

REZAČ MINERALNE VUNE

Broj	specifikacija	
16198	44,5 33 cm	12

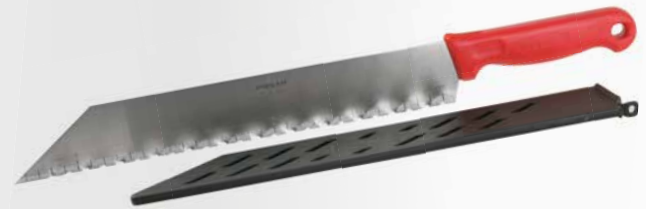
**FESTA**

NOŽ ZA MINERALNU VUNU I STIROPOR

· za mineralnu vunu, polistiren

Broj	specifikacija	
16199	48 35 cm	10

**FESTA**

MAČETA

Broj	specifikacija	
45069	490 mm	6

TEFLON

3 mm

**FESTA**

MAČETA

Broj	specifikacija	
44950	490 mm	4

TEFLON

3 mm



MAČETA NE HRĐAJUĆI ČELIK

Broj	specifikacija	
45083	430 mm	12
45084	600 mm	6

INOX



MAČETA

· drška od jasena

Broj	specifikacija	
45081	510 mm	36
45082	710 mm	36

**FESTA®****LOVAČKI NOŽ**

- najlonska ručka
- oštrica presvučena teflonom
- kućište s osiguračem i kopčom



INOX	TEFLON	NYLON	Broj	specifikacija	
			16234	21 10 cm	10

**FESTA®****LOVAČKI NOŽ**

INOX	TEFLON	Broj	specifikacija	
		16229	23 10 cm	12

**FESTA®****VIŠENAMJENSKI DLIJETO**

- zadebljana oštrica

MOQ
12

INOX	Broj	specifikacija	
	16231	20 8 cm	12

**TEHNIČKI NOŽ**

- zadebljana oštrica

INOX	Broj	specifikacija	
	16230	21 10 cm	12

**FESTA®****NOŽ ZA TEPIHE I PLASTIČNE PODNE PODLOGE**

Broj	specifikacija	
16225	20 8,5 cm	12

**FESTA®****ELEKTRIČARSKI NOŽ**

- zadebljana oštrica

INOX	Broj	specifikacija	
	16212	15 3,2 cm	12

**FESTA®****NOŽ ZA SKIDANJE IZOLACIJE**

Broj	specifikacija	
16201	Ø 8 - 27 mm	10

**FESTA®****ELEKTRIČARSKI NOŽ**

INOX	Broj	specifikacija	
	16211	20 8,5 cm	10

**FESTA®****ELEKTRIČARSKI NOŽ**

INOX	Broj	specifikacija	
	16210	20,5 9 cm	10

**FESTA**

DŽEPNI NOŽ



INOX

Broj	specifikacija
16219	19 11 cm

24

**FESTA**

DŽEPNI NOŽ



INOX

Broj	specifikacija
16218	18,5 10,5 cm

24

**FESTA**

DŽEPNI NOŽ



INOX

Broj	specifikacija
16220	18,5 11 cm

24

**FESTA**

DŽEPNI NOŽ



INOX

Broj	specifikacija
16235	17,5 8,5 cm

24

**FESTA**

DŽEPNI NOŽ



INOX

Broj	specifikacija
16221	21 12 cm

24

**FESTA**

DŽEPNI NOŽ



INOX

Broj	specifikacija
16236	22,5 10 cm

24

**FESTA**

DŽEPNI NOŽ



INOX

Broj	specifikacija
16209	14,5 5,5 cm

1

**FESTA**

DŽEPNI NOŽ



INOX

Broj	specifikacija
16222	20 12 cm

24

**FESTA**

DŽEPNI NOŽ



INOX

ALU	Broj	specifikacija
	16223	18,5 10,5 cm

24

**FESTA****DŽEPNI NOŽ**

· 5 funkcija

INOX

Broj 16228 specifikacija 27 | 10,5 cm



24

**FESTA****DŽEPNI NOŽ**

· 10 funkcija

INOX

Broj 16226 specifikacija 17,5 | 7 cm



24

**DŽEPNI NOŽ**

· 7 funkcija

INOX

Broj 16224 specifikacija 17,5 | 7 cm



24

**DŽEPNI NOŽ LOVAČKI**

· 3 funkcija

INOX

Broj 16227 specifikacija 20,5 | 10 cm



24

**FESTA****MULTIFUNKCIJSKA DŽEPNA KLIJEŠTA**· 9 funkcija
· torba**CrV**

Broj 16232 specifikacija

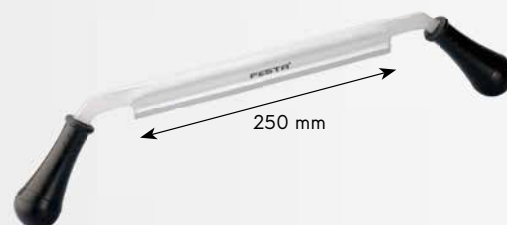

12

NEW**FESTA****MAKLJA****CrV**

Broj 24132 specifikacija 250/490 mm



1

**BLANJALICA**

Broj 19510 specifikacija 220 x 65 x 130 mm, nož 48 mm 1

**BLANJALICA**

Broj 19515 specifikacija 200 x 55 x 130 mm, nož 39 mm 1

**BLANJALICA**

Broj 19520 specifikacija 225 x 27 x 155 mm, nož 27 mm 1



FESTA

DLIJETO

CrV

Broj	specifikacija	
19490	6 mm 290 mm	6
19491	8 mm 290 mm	6
19492	10 mm 290 mm	6
19493	12 mm 290 mm	6
19494	14 mm 290 mm	6
19495	16 mm 290 mm	6

Broj	specifikacija	
19496	18 mm 290 mm	6
19497	20 mm 290 mm	6
19498	22 mm 290 mm	6
19499	25 mm 290 mm	6
19501	32 mm 290 mm	6
19502	38 mm 290 mm	6



FESTA

VIŠENAMJENSKO DLIJETO

INOX

Broj	specifikacija	
16231	20 80 mm	12



MOQ 12



FESTA

KOMPLET DLIJETA

CrV

5x

Broj	specifikacija	
19451	6 mm 10 mm 15 mm 20 mm 25 mm	10



FESTA

KOMPLET DLIJETA

CrV

4x

Broj	specifikacija	
19457	6 mm 12 mm 19 mm 25 mm	10



KOMPLET DLIJETA

4x

Broj	specifikacija	
19455	8 mm 12 mm 19 mm 25 mm	30

FESTA



FESTA

KOMPLET DLIJETA

CrV

8x

Broj	specifikacija	
19458	365 125mm	1



KOMPLET DLIJETA

4x

Broj	specifikacija	
19450	8 mm 12 mm 19 mm 25 mm	20



KOMPLET DLIJETA

12x CrV

Broj	specifikacija	
19459		5

FESTA

BRUS ZA NOŽEVE I ŠKARE 16v1



	30° Anvil	
	45° Anvil	
	50° Anvil	
	23° Bypass	
	35° Bypass	
	65° Bypass	
	Deburr Tool	



Broj specifikacija

45073



1



BRUS

Broj	specifikacija	
45370	250 x 33 x 18 mm	20

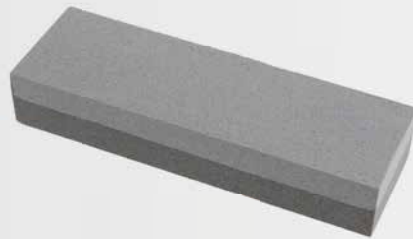

BRUS

Broj	specifikacija	
45045	150 x 50 x 30 mm	1



BRUS ZA KOSU

Broj	specifikacija	
45046	205 x 15 mm	100



BRUS ZA NOŽEVE I ŠKARE

Broj	specifikacija	
16991		20



BRUS ZA NOŽEVE I ŠKARE

Broj	specifikacija	
16990	Ø 50 mm	1



BRUS ZA NOŽEVE I ŠKARE

Broj	specifikacija	
45048		20



BRUS ZA NOŽEVE I ŠKARE 6 V 1

Broj	specifikacija	
45068		10

FESTA
POWER X TOOLS

ZAVARIVAČ CIJEVI

Napon / frekvencija:	230 V / 50 Hz
Potrošnja energije:	750 / 1500 W
Temperatura:	0-300 C°
Promjer:	Ø 20,25,32,40,50,63 mm
Težina:	1,6 kg



oprema: mjerna traka, libela, odvijač, šesterokutni ključ, škare za cijevi, 4 x adapter za zavarivanje

 Broj
17182

1

FESTA
POWER X TOOLS

ZAVARIVAČ CIJEVI

Napon / frekvencija:	230 V / 50 Hz
Potrošnja energije:	800 / 1000 W
Temperatura:	0-300 C°
Promjer:	Ø 16, 20, 25, 32 mm
Težina:	1 kg



oprema: šesterokutni ključ, 4 x adapter za zavarivanje

 Broj
17183

1

FESTA
KLIJEŠTA ZA PVC CIJEVI

 ID max.
42 mm

Broj	specifikacija	
17027		10
16315	rezervno sječivo	1

REZERVNA OŠTRICA ZA SJEKAČ PVC CIJEVI

za 17027

Broj	specifikacija	
16315		1

FESTA

FESTA
KLIJEŠTA ZA PVC CIJEVI

 ID max.
32 mm

Broj	specifikacija	
17037		12

KLIJEŠTA ZA PVC CIJEVI

 ID max.
42 mm

Broj	specifikacija	
17026		6



NEW

FESTA

REZAČ CIJEVI

INOX ALU

ALU Cu PVC



Broj	specifikacija	
16305	Ø 22 mm	10
16306	Ø 15 mm	10
16307 NEW	Ø 28 mm	10



NEW

FESTA

REZAČ PVC CIJEVI

PLASTIC INOX

PVC



Broj	specifikacija	
16308	Ø 20 - 50 mm	10

FESTA

REZAČ CIJEVI

Ø 15 mm
Ø 22 mm
Ø 28 mm

3x INOX ALU

ALU Cu PVC

Broj	specifikacija	
16309		1



FESTAREZAČ TANKIH
CIJEVI

 3-22
mm

Broj	specifikacija	
16301		10
16311	rezervna oštrica	1

FESTAREZAČ TANKIH
CIJEVI

 6-64
mm

Broj	specifikacija	
16304		6
16312	rezervna oštrica	1

REZAČ TANKIH
CIJEVI

 3-32
mm

Broj	specifikacija	
16303		10
16311	rezervna oštrica	1

REZAČ TANKIH
CIJEVI

 3-32
mm

Broj	specifikacija	
16300		10
16310	rezervna oštrica	1

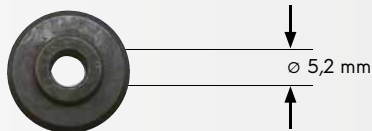
REZERVNI REZNI
KOTAČIĆ ZA REZAČ
CIJEVI

Broj	specifikacija	
16310	Ø 17,5 mm x 6 mm za 16300	1
16311	Ø 18,0 mm x 4,5 mm za 16303, 16301	1
16312	Ø 27,5 mm x 6 mm za 16304	1

**FESTA**KLIJEŠTA
ZA PVC LAJSNE

letvice, cijevi, profili

 5x

Ø 17 mm	Ø 20 mm	Ø 27 mm
---------	---------	---------

Broj	specifikacija	
17050	60 250 mm	8

**NEW****FESTA**NOŽ ZA
OBRADU CIJEVI

 6-38
mm

ALU



Broj	specifikacija	
16319	Ø 6 - 38 mm	1

FESTAALAT ZA OBRADU
ZAVRŠETKA
NAVOJA

1/4"

Broj	specifikacija	
16321		1

NOŽ ZA
OBRADU CIJEVI

 6-32
mm

Broj	specifikacija	
16320		1

FESTARUČNA
GLODALICA

 HSS

Ø 25 mm

90°



Broj	specifikacija	
20360		10

RUČNA
GLODALICA

Broj	specifikacija	
20361		1



ODVIJAČ PLOSNATI

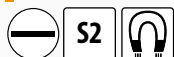

Broj	specifikacija	
18113	3 x 75 mm	12
18114	4 x 100mm	12
18115	5,5 x 125 mm	12
18116	6,5 x 150 mm	12
18118	8 x 175 mm	6
18120	10 x 200 mm	6



ODVIJAČ PLOSNATI KRATKI

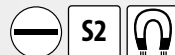

Broj	specifikacija	
18124	5,5 x 38 mm	12
18125	6,5 x 38 mm	12



ODVIJAČ PHILIPS

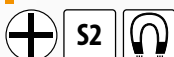

Broj	specifikacija	
18210	0 x 75 mm	12
18211	1 x 75 mm	12
18212	2 x 100 mm	12



ODVIJAČ PHILIPS KRATKI

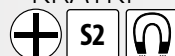

Broj	specifikacija	
18215	1 x 38 mm	12
18216	2 x 38 mm	12



ODVIJAČ POZIDRIVE



Broj	specifikacija	
18310	0 x 75 mm	12
18311	1 x 100 mm	12
18312	2 x 100 mm	12
18313	3 x 150 mm	6



ODVIJAČ POZIDRIVE KRATKI

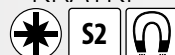

Broj	specifikacija	
18321	1 x 38 mm	12
18322	2 x 38 mm	12



ODVIJAČ TORX



Broj	specifikacija	
18350	T6	12
18351	T7	12
18352	T8	12
18353	T9	12
18354	T10	12
18355	T15	12
18356	T20	12
18357	T25	12
18358	T27	12
18359	T30	12
18360	T40	6



ODVIJAČ + 7 BITOVA



Broj	specifikacija	
18425		10

- ⊖ S 5 · 6 mm
- ⊕ PH 1 · 2 · 3
- ⊛ T 15 · 20

NEW



KOMPLET ODVIJAČA I BITOVA

114x S2



Broj	specifikacija	
18434		1

1

- odvijač ključ
- odvijač ključ mini
- odvijač
 - ⊖ 3x75, 5x75, 5x100, 6x100, 6x150, 8x150
 - ⊕ 0x75, 1x75, 1x100, 2x100, 2x150
 - ⊛ T10x75, T15x75
 - ⊖ VDE 2.5x75mm, 4.0x100mm
- el. ispitivač
 - ⊖ 2.5x40, 3.0x40mm
 - ⊕ 00x40mm, 0x40mm,
 - ⊛ T6x40mm, T7x40mm
- imbus ključ
 - ⊖ 1/16", 5/64", 3/32", 1/8", 5/32", 3/16", 7/32", 1/4"
 - 1.5, 2.0, 2.5, 3.0, 4.0, 5.0, 5.5, 6.0mm
- nasadni ključ
 - ⊖ 6mm, 7mm, 8mm, 9mm, 10mm, 11mm
 - ⊕ SL 3mm, 4mm, 4.5mm, 5mm, 5.5mm, 6mm, 7mm, 8mm
 - ⊕ PH0, PH0, PH1, PH1, PH2, PH2, PH3, PH3
 - ⊕ PZ0, PZ0, PZ1, PZ1, PZ2, PZ2, PZ3, PZ3,
 - ⊕ T6, T8, T10, T15, T20, T25, T27, T30, T35, T40
 - ⊕ H1.5, H2.5, H3.0, H3.5, H4.0, H4.5, H5.0, H5.5, H6, H8
 - ⊖ S0, S1, S2, S3
- bit
 - ⊖ SL 1.5mm, 2.0mm, 2.5mm, 3.0mm, 4.0mm
 - ⊕ PH000, PH00, PH0, PH1
 - ⊕ T4, T5, T6, T7, T8, T9, T10, T15, T20
 - ⊕ H0.7, H0.9
- mini bit
 - ⊖ SL 1.5mm, 2.0mm, 2.5mm, 3.0mm, 4.0mm
 - ⊕ PH000, PH00, PH0, PH1
 - ⊕ T4, T5, T6, T7, T8, T9, T10, T15, T20
 - ⊕ H0.7, H0.9

FESTA
INDUSTRY

KOMPLET ODVIJAČA

 S 6,5x38 · 5,5x75 · 6,5x100 · 8x150 mm
2,5x50 · 3x50 mm

 PH 2x38 · 1x75 · 2x100 · 3x150 mm
0x50 · 00x50 mm

T 5x50 · 6x50 · 7x50 · 8x50 · 9x50 · 10x50 mm

S2 **18x**

Broj specifikacija

18424
6

FESTA
INDUSTRY

KOMPLET ODVIJAČA I BITOVA

S 3 x 75 · 4x100 · 5,5x125 · 6,5 x 150mm

PH1 x 100 · 2 x 100mm

adapter 1/4"

 bits:

- S 4 · 5 · 6 · 7
- PH1 · 2 · 3
- PZ1 · 2 · 3
- T 10 · 15 · 20 · 25 · 30
- H 2 · 3 · 4 · 5 · 6

S2 **27x**

Broj specifikacija

18422
27 kom
6
FESTA
INDUSTRY

KOMPLET ODVIJAČA

S 3x75 · 5x100 · 6,5x150mm

PH 0 · 1 · 2 · 3

S2 **7x**

Broj specifikacija

18402
6

FESTA
INDUSTRY

KOMPLET ODVIJAČA

S 3x75 · 5x100 · 6x150mm

PH 0 · 1 · 2

S2 **6x**

Broj specifikacija

18403
6

FESTA
INDUSTRY

KOMPLET ODVIJAČA

S 3x75 · 5x100 · 6,5x150 mm

PZ 0 · 1 · 2

S2 **6x**

Broj specifikacija

18404
6

FESTA
INDUSTRY

KOMPLET TORX ODVIJAČA

T 10 · 15 · 20 · 25 · 30

S2 **5x**

Broj specifikacija

18340
6

FESTA
INDUSTRY

VDE ODVIJAČ ELEKTRO PLOSNATI



Broj	specifikacija		
18088	3 x 75 mm	S2	12
18089	4 x 100 mm	CrV	12
18090	5,5 x 125 mm	CrV	12
18091	6,5 x 150 mm	CrV	12
18092	8 x 175 mm	CrV	12

FESTA
INDUSTRY

VDE ODVIJAČ ELEKTRO PHILIPS



Broj	specifikacija		
18080	PH 0 x 60 mm	S2	12
18081	PH 1 x 80 mm	CrV	12
18082	PH 2 x 100 mm	CrV	12
18083	PH 3 x 150 mm	CrV	12

FESTA
INDUSTRY

KOMPLET ELEKTRO ODVIJAČA

S 4x100 · 5,5x125 mm · el. ispitivač 0 - 250 V

PH 0x60 · 1x80 · 2x100 mm



Broj	specifikacija	
18413		6

FESTA
INDUSTRY

VDE ODVIJAČ ELEKTRO POZIDRIVE



Broj	specifikacija		
18084	PZ 0 x 60 mm	S2	12
18085	PZ 1 x 80 mm	CrV	12
18086	PZ 2 x 100 mm	CrV	12
18087	PZ 3 x 150 mm	CrV	12



FESTA

ODVIJAČ UDARNI PLOSNATI



Broj	specifikacija		
18062	5,5 x 100 mm		12
18063	7 x 125 mm		6
18064	8 x 150 mm		8
18065	10 x 175 mm		6
18066	10 x 200 mm		6
18067	10 x 250 mm		6



FESTA

KOMPLET ELEKTRO ODVIJAČA

S 4x100 · 5,5x125 · 6,5x150 mm

el. ispitivač 0 - 250 V

PH 0x75 · 1x100 · 2x100 mm



Broj	specifikacija	
18410		40



FESTA

ODVIJAČ UDARNI PHILIPS



Broj	specifikacija		
18070	PH 1 x 80 mm		8
18071	PH 2 x 100 mm		12
18072	PH 3 x 150 mm		6



FESTA

ODVIJAČ UDARNI POZIDRIVE



Broj	specifikacija		
18075	PZ 1 x 80 mm		12
18076	PZ 2 x 100 mm		12
18077	PZ 3 x 150 mm		6



FESTA

ODVIJAČ UDARNI

S 7 x 35 · 8 x 35 · 8 x 70 mm

PH 2 x 35 · 3 x 35 · 3 x 70 mm



Broj	specifikacija	
18411		1



FESTA

KOMPLET UDARNIH ODVIJAČA

S 5 · 6 · 8 mm

PH 1 · 2 · 3



Broj	specifikacija	
18423		10

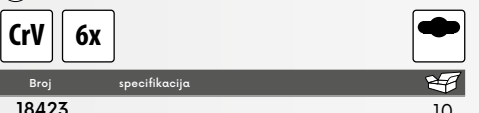

**FESTA****KOMPLET ODVIJAČA I BITOVA**

⊖ S 3x75 · 4x75 · 6x100 · 8x150 mm

⊕ PH 1x75 · 2x100 mm

○ adapter 1/4"

bits: ⊖ S 4 · 5 · 6 · 7 mm

⊕ PH 1 · 2 · 3

⊕ PZ 1 · 2 · 3

⊕ T 10 · 15 · 20

○ ↔ ⊕ adapter



Broj	specifikacija
18418	



Broj	specifikacija
10	

**FESTA****KOMPLET ODVIJAČA**

⊖ S 3x60 · 4x75 · 6x100 · 6x125 mm

⊕ PH 0x60 · 1x75 · 2x100 mm



Broj	specifikacija
18400	



Broj	specifikacija
10	

**FESTA****KOMPLET ODVIJAČA**

⊖ S 3x60 · 6x100 · 6x125 mm

⊕ PH 1x75 · 2x100 mm



Broj	specifikacija
18401	



Broj	specifikacija
1	

FESTA**ODVIJAČ PLOSNATI**

Broj	specifikacija	
18101	3 x 75 mm	10
18102	4 x 100 mm	10
18103	5,5 x 100 mm	10
18104	5,5 x 125 mm	10
18105	6,5 x 100 mm	10
18106	6,5 x 125 mm	10
18107	8 x 160 mm	10
18108	10 x 160 mm	10

FESTA**ODVIJAČ PHILIPS**

Broj	specifikacija	
18201	0 x 75 mm	10
18202	1 x 75 mm	10
18203	2 x 100 mm	10
18204	3 x 150 mm	10

FESTA**ODVIJAČ POZIDRIVE**

Broj	specifikacija	
18301	0 x 75 mm	10
18302	1 x 75 mm	10
18303	2 x 100 mm	10
18304	3 x 150 mm	10

FESTA**NASTAVAK ODVIJAČ ZA BITOVE**

Broj	specifikacija	
18110		12

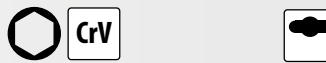
**FESTA****ODVIJAČ KLJUČ**

Broj	specifikacija	
18455	6 mm	12
18456	7 mm	12
18460	13 mm	12

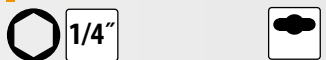
**FESTA****FLEXI ODVIJAČ ZA BITOVE**

Broj	specifikacija	
18451		12

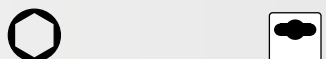
**FESTA****FLEXI ODVIJAČ**

Broj	specifikacija	
18450	7 mm	6





**ODVIJAČ S RAČNOM
ZA BITOVE
I NASADNE KLJUČEVE**

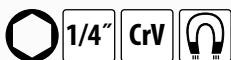

Broj 18433 specifikacija

6



**T ODVIJAČ
S RAČNOM**

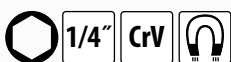

Broj 18608 specifikacija

6



**T ODVIJAČ
+ 20 NASTAVAKA**

- ⊖ S 3 · 4 · 5 · 6 · 8 mm
- ⊕ PH 0 · 1 · 2 · 3
- adapter + 5 · 6 · 7 · 8 · 9 · 10 · 11 · 12 · 13 mm



Broj 18420 specifikacija

5



**KOMPLET FINIH BITOVA
S ADAPTEROM**

- ⊖ S 1.5 · 2 · 2.5 · 3 · 3.5 mm
- ⊕ PH 000 · 00 · 0 · 1
- ⊛ PZ 0 · 1
- ⊛ T 5 · 6 · 7 · 8 · 9 · 10 · 15 · 20
- ⊛ H 0.9 · 1.3 · 2.0 · 2.5 · 3.0 · 4.0



Broj 18431 specifikacija

6



ODVIJAČ S BITOVIMA

- 1/4" ⊖ ↔ ⊕ 1/4"
- ⊖ S 3 · 4 · 5 · 6 · 7 · 5 L
- ⊕ PH 1 · 2 · 3 · 1L · 2L
- ⊛ PZ 1 · 2 · 3 · 1L · 2L
- ⊛ H 2 · 2.5 · 3 · 4 · 5 · 6
- ⊛ T 10 · 15 · 20 · 25 · 27 · 30
- ⊛ SQ 0 · 1 · 2 · 3
- 1/4" 5 · 6 · 7 · 8 · 9 · 10 · 11 · 12 · 13 mm



Broj 18419 specifikacija

6



KOMPLET ODVIJAČA - FINI

- ⊖ S 1,5x50 · 2x50 · 2,5x50 mm
- ⊕ PH 000x50 · 00x50 · 0x50 mm



Broj 18416 specifikacija

6



**KOMPLET ODVIJAČA -
FINI TORX**

- ⊛ T 4 · 5 · 6 · 7 · 8 · 9 · 10x50 mm



Broj 18417 specifikacija

6



**KOMPLET ELEKTRO
ODVIJAČA FINI**

- ⊖ S 2,4 · 3,0 mm
- ⊕ PH 0 · 1
- ⊛ T 6 · 8

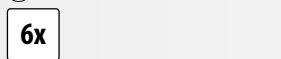

Broj 18415 specifikacija

10

FESTA

NEW

FESTA
EL. ISPITIVAČ

· AC - 110 V, 250 V



Broj specifikacija

18427

24

EL. ISPITIVAČ

 DIN VDE 0680
73/23 EEC

Broj specifikacija

18426 0 - 250 V



1

URARSKI ODVIJAČI

S 1,4 · 2,0 · 2,4 · 3,0 mm

PH 0 · 1

6x HOBBY

Broj specifikacija

18408

10

FESTA
OTVARAČ ZA BOCE

Broj specifikacija

18437



5



**KUTNI ADAPTER
ZA BITOVE 90°**

Broj

18910

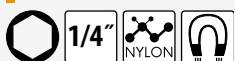

25

RAČNA ZA BITOVE

Broj specifikacija

18435 93 mm



1

URARSKI ODVIJAČI

S 1,0 · 1,2 · 1,4 · 1,8 · 2,4 · 3,0 mm

PH 00 · 0 · 1

11x HOBBY

Broj specifikacija

18409

48





TORZIJSKI BIT PH - 50 MM



Broj	specifikacija	
18715	PH1 x 50 mm	1
18716	PH2 x 50 mm	1
18717	PH3 x 50 mm	1



TORZIJSKI BIT PZ - 50 MM



Broj	specifikacija	
18710	PZ1 x 50 mm	1
18711	PZ2 x 50 mm	1
18712	PZ3 x 50 mm	1



TORZIJSKI BIT T - 50 MM

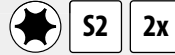

Broj	specifikacija	
18720	T10 x 50 mm	1
18721	T15 x 50 mm	1
18722	T20 x 50 mm	1
18723	T25 x 50 mm	1
18724	T30 x 50 mm	1
18725	T40 x 50 mm	1



TORZIJSKI BIT

- ⊕ PH 2 · 2
- ⊕ PZ 2
- ⊕ T 15 · 15 · 20 · 20 · 25 · 30 · 40

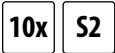

Broj	specifikacija	
18432		1



NEW



nastavci od najkvalitetnijih materijala S2

Tehnologija proizvodnje

križni i plosnati nastavci su proizvedeni specijalnom tehnologijom preciznog kovanja koja omogućava postizanje visoke točnosti oblika i ujedno povećane otpornosti i do 20%. Nakon kovanja su nastavci kaljeni tako da dobiju optimalnu tvrdoću i izdržljivost. Kako bi se osiguralo da ne proklizuju dodatno su pjeskareni

TiN sloj

dvostruko nanesen sloj na području kontakta sa vijkom maksimalno povećava tvrdoću i habanje, a pjeskarenjem se postiglo da ne proklizavaju prilikom korištenja

Dijamantna zrna

prilikom korištenja se doslovce 'zagrizu' za glavu vijka a drže se i prilikom maksimalnog okreta.

Protuklizni utori

na vrhu kovanog bit nastavka se nalazi dodatni sloj koji sprječava proklizavanje prilikom uporabe

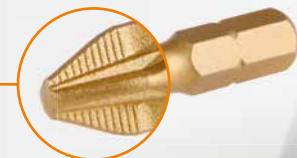



FESTA
INDUSTRY

BIT PH

2x

Broj	specifikacija	
18632A	PH2 x 25 mm	1
18633A	PH3 x 25 mm	1

FESTA
INDUSTRY

BIT PZ

2x **S2**

Broj	specifikacija	
18636A	PZ1 x 25 mm	1
18637A	PZ2 x 25 mm	1
18638A	PZ3 x 25 mm	1

FESTA
INDUSTRY

BIT T

2x **S2**

Broj	specifikacija	
18827A	T20 x 25 mm	1
18828A	T25 x 25 mm	1
18830A	T30 x 25 mm	1
18831A	T40 x 25 mm	1

FESTA
INDUSTRY

BIT PH DIAMANT

S2 **TiN** **DIN 3128**

MOQ 5

Broj	specifikacija	
18770	PH1 x 25 mm	5
18771	PH2 x 25 mm	5
18772	PH3 x 25 mm	5

FESTA
INDUSTRY

BIT PZ DIAMANT

S2 **TiN** **DIN 3128**

MOQ 5

Broj	specifikacija	
18775	PZ1 x 25 mm	5
18776	PZ2 x 25 mm	5
18777	PZ3 x 25 mm	5

FESTA
INDUSTRY

BIT S

S2

MOQ 5

Broj	specifikacija	
18620	S 3 x 25 mm	5
18621	S 4 x 25 mm	5
18623	S 5 x 25 mm	5
18625	S 6 x 25 mm	5
18627	S 7 x 25 mm	5
18628	S 8 x 25 mm	5

FESTA
INDUSTRY

BIT PH

S2

Broj	specifikacija	
18630	PH0 x 25 mm	5
18631	PH1 x 25 mm	5
18632	PH2 x 25 mm	5
18633	PH3 x 25 mm	5
18634	PH4 x 25 mm	5

FESTA
INDUSTRY

BIT PZ

S2

Broj	specifikacija	
18635	PZ0 x 25 mm	5
18636	PZ1 x 25 mm	5
18637	PZ2 x 25 mm	5
18638	PZ3 x 25 mm	5
18639	PZ4 x 25 mm	5

FESTA
INDUSTRY

BIT PH

S2

MOQ 25

Broj	specifikacija	
18685	PH2 x 25 mm	25

FESTA
INDUSTRY

BIT PZ

S2

MOQ 25

Broj	specifikacija	
18680	PZ2 x 25 mm	25

FESTA
INDUSTRY

BIT PH

S2

MOQ 10

Broj	specifikacija	
18640	PH1 x 70 mm	10
18641	PH2 x 70 mm	10

FESTA
INDUSTRY

BIT PZ

S2

MOQ 10

Broj	specifikacija	
18645	PZ1 x 70 mm	10
18646	PZ2 x 70 mm	10

FESTA
INDUSTRY

BIT PH

S2 **TiN**

MOQ 5

Broj	specifikacija	
18760	PH0 x 25 mm	5
18761	PH1 x 25 mm	5
18762	PH2 x 25 mm	5
18763	PH3 x 25 mm	5
18764	PH4 x 25 mm	1

FESTA
INDUSTRY

BIT PZ

S2 **TiN**

MOQ 5

Broj	specifikacija	
18765	PZ0 x 25 mm	5
18766	PZ1 x 25 mm	5
18767	PZ2 x 25 mm	5
18768	PZ3 x 25 mm	5
18769	PZ4 x 25 mm	5

FESTA
INDUSTRY

BIT S

S2 **TiN**

MOQ 5

Broj	specifikacija	
18750	S 3 x 25 mm	5
18751	S 4 x 25 mm	5
18753	S 5 x 25 mm	5
18755	S 6 x 25 mm	5



BIT H



MOQ 5

Broj	specifikacija	
18800	H 1,5 x 25 mm	5
18801	H 2,0 x 25 mm	5
18802	H 2,5 x 25 mm	5
18803	H 3,0 x 25 mm	5
18804	H 4,0 x 25 mm	5
18805	H 5,0 x 25 mm	5
18806	H 5,5 x 25 mm	5
18807	H 6,0 x 25 mm	5



BIT TTA



MOQ 5

Broj	specifikacija	
18835	TTa 5 x 25 mm	10
18836	TTa 6 x 25 mm	5
18837	TTa 7 x 25 mm	5
18838	TTa 8 x 25 mm	5
18839	TTa 9 x 25 mm	5
18840	TTa 10 x 25 mm	5
18841	TTa 15 x 25 mm	5
18842	TTa 20 x 25 mm	5
18843	TTa 25 x 25 mm	5
18844	TTa 27 x 25 mm	5
18845	TTa 30 x 25 mm	5
18846	TTa 40 x 25 mm	5
18847	TTa 45 x 25 mm	5



BIT T



MOQ 5

Broj	specifikacija	
18820	T5 x 25 mm	5
18821	T6 x 25 mm	5
18822	T7 x 25 mm	5
18823	T8 x 25 mm	5
18824	T9 x 25 mm	5
18825	T10 x 25 mm	5
18826	T15 x 25 mm	5
18827	T20 x 25 mm	5
18828	T25 x 25 mm	5
18829	T27 x 25 mm	5
18830	T30 x 25 mm	5
18831	T40 x 25 mm	5
18832	T45 x 25 mm	5



BIT HTA



MOQ 5

Broj	specifikacija	
18810	HTa 1,5 x 25 mm	5
18811	HTa 2,0 x 25 mm	5
18812	HTa 2,5 x 25 mm	5
18813	HTa 3,0 x 25 mm	5
18814	HTa 4,0 x 25 mm	5
18815	HTa 5,0 x 25 mm	5
18816	HTa 5,5 x 25 mm	5
18817	HTa 6,0 x 25 mm	5



BIT SQ



MOQ 5

Broj	specifikacija	
18850	SQ 0 x 25 mm	5
18851	SQ 1 x 25 mm	5
18852	SQ 2 x 25 mm	5
18853	SQ 3 x 25 mm	5



BIT T



MOQ 3

Č.p.	specifikacija	
17980	T30 x 35 mm	3
17981	T40 x 35 mm	3
17982	T45 x 35 mm	3
17983	T50 x 35 mm	3



BIT SD



MOQ 5

Broj	specifikacija	
18855	SD 6 x 25 mm	5
18856	SD 8 x 25 mm	5



BIT T



MOQ 3

Broj	specifikacija	
17970	T20 x 75 mm	3
17971	T25 x 75 mm	3
17972	T30 x 75 mm	3
17973	T40 x 75 mm	3

Broj	specifikacija	
17974	T45 x 75 mm	3
17975	T50 x 75 mm	3
17976	T55 x 75 mm	3



BIT TS



MOQ 5

Broj	specifikacija	
18864	TS 4 x 25 mm	5
18865	TS 6 x 25 mm	5



BIT 5/32', 3/16'



MOQ 5

Broj	specifikacija	
18866	5/32 x 25 mm	5
18867	3/16 x 25 mm	5



BIT TW



MOQ 5

Broj	specifikacija	
18860	TW 1 x 25 mm	5
18861	TW 2 x 25 mm	5
18862	TW 3 x 25 mm	5
18863	TW 4 x 25 mm	5



BIT XZN



MOQ 5

Broj	specifikacija	
18870	M4 x 25 mm	5
18871	M5 x 25 mm	5
18872	M6 x 25 mm	5
18873	M8 x 25 mm	5
18874	M10 x 25 mm	5



BIT ADAPTER

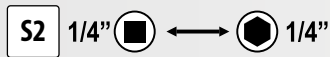

MOQ 5

Broj	specifikacija	
18868	25 mm	5



BIT ADAPTER

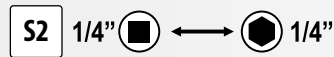

MOQ 5

Broj	specifikacija	
18869	50 mm	5

FESTA
INDUSTRY

BITOVI ZA GIPSANE PLOČE



Broj	specifikacija	
18795	PH 2 x 25 mm	24

FESTA
INDUSTRY

BITOVI ZA GIPSANE PLOČE

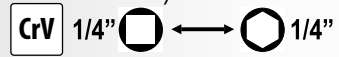

Broj	specifikacija	
18796	PH 2 x 55 mm	24

FESTA
INDUSTRY
ADAPTER SAVINUTA
RAČNA 1/4" - BITMOQ
5

Broj	specifikacija	
18619		5



FESTA
INDUSTRY
NASTAVAK ZA BITOVE
MAGNETNIMOQ
5

Broj	specifikacija	
18600	1/4" x 60 mm	5

FESTA
INDUSTRY

NASTAVAK ZA BITOVE

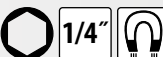
· szybkie wydanie | brzozażezujuci

MOQ
5

Broj	specifikacija	
18601	1/4" x 60 mm	5



FESTA
INDUSTRY

NASTAVAK ZA BITOVE

· sa graničnikom

MOQ
5

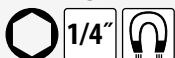
Broj	specifikacija	
18602	1/4" x 60 mm	5



FESTA
INDUSTRY
NASTAVAK ZA BITOVE
MAGNETNI

Broj	specifikacija	
18797	1/4" x 60 mm	1

FESTA
INDUSTRY

NASTAVAK ZA BITOVE

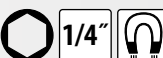
· szybkie wydanie | brzozażezujuci



Broj	specifikacija	
18798	1/4" x 60 mm	1

FESTA
INDUSTRY

NASTAVAK ZA BITOVE

· sa graničnikom

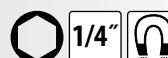

Broj	specifikacija	
18799	1/4" x 60 mm	1

FESTA
INDUSTRY

NASTAVAK ZA BITOVE



Broj	specifikacija	
18605	150 mm	1

FESTA
INDUSTRY
ADAPTER SDS+ +
ZA BITOVE 1/4"

Broj	specifikacija	
20743	75 mm	1



NASTAVAK ZA BITOVE



Broj	specifikacija	
18607	80 mm	25

FESTA

NASTAVAK ZA BITOVE
MAGNETNI



Broj 18609
specifikacija 90mm



25

**WEST
BERG**

ADAPTER
BIT 1/4" ZA SDS+

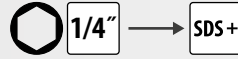

Broj 20742
specifikacija



1

**FESTA
INDUSTRY**

KOMPLET
BITOVA
I ADAPTERA

- 10x ⊕ 18630 PH0
- 10x ⊕ 18631 PH1
- 10x ⊕ 18632 PH2
- 10x ⊕ 18633 PH3
- 10x ⊕ 18635 PZ0
- 10x ⊕ 18636 PZ1
- 10x ⊕ 18637 PZ2
- 10x ⊕ 18638 PZ3
- 10x ⊕ 18761 PH1 TiN
- 10x ⊕ 18762 PH2 TiN
- 10x ⊕ 18763 PH3 TiN
- 10x ⊕ 18766 PZ1 TiN
- 10x ⊕ 18767 PZ2 TiN
- 10x ⊕ 18768 PZ3 TiN
- 10x ⊕ 18770 PH1 DIAMANT
- 10x ⊕ 18771 PH2 DIAMANT
- 10x ⊕ 18775 PZ1 DIAMANT
- 10x ⊕ 18776 PZ2 DIAMANT
- 10x ⊙ 18814 4,0HTa
- 10x ⊙ 18815 5,0HTa
- 10x ⊕ 18842 20TTa
- 10x ⊕ 18845 30TTa
- 10x ⊕ 18795 PH2 za gipsane ploče
- 5x 18612 adapter 1/4" 8mm
- 5x 18613 adapter 1/4" 10mm
- 5x 18600 1/4" 60mm nastavak za bitove magnetni
- 5x 18601 1/4" 60mm nastavak za bitove brzozatezujuci
- 5x 18602 1/4" 65mm nastavak za bitove sa granicnikom



Broj 18993
specifikacija

1

**FESTA
INDUSTRY**

KOMPLET
BITOVA

- 10x ⊕ 18631 PH1
- 10x ⊕ 18632 PH2
- 10x ⊕ 18633 PH3
- 10x ⊕ 18636 PZ1
- 10x ⊕ 18637 PZ2
- 10x ⊕ 18638 PZ3
- 10x ⊕ 18761 PH1 TiN
- 10x ⊕ 18762 PH2 TiN
- 10x ⊕ 18763 PH3 TiN
- 10x ⊕ 18766 PZ1 TiN
- 10x ⊕ 18767 PZ2 TiN
- 10x ⊕ 18768 PZ3 TiN
- 10x ⊙ 18804 H 4
- 10x ⊙ 18805 H 5
- 10x ⊕ 18825 T 10
- 10x ⊕ 18826 T 15
- 10x ⊕ 18827 T 20
- 10x ⊕ 18828 T 25
- 10x ⊕ 18830 T 30
- 10x ⊕ 18831 T 40

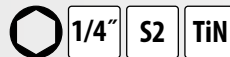

Broj 18994
specifikacija

1

**FESTA
INDUSTRY**

ADAPTER 1/4"

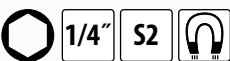

Broj	specifikacija	
18610	6 mm	5
18611	7 mm	5
18612	8 mm	5



Broj	specifikacija	
18613	10 mm	5
18614	12 mm	5
18615	13 mm	5

**FESTA
INDUSTRY**

ADAPTER 1/4"



Broj	specifikacija	
18610A	6 mm	5
18611A	7 mm	5
18612A	8 mm	5



Broj	specifikacija	
18613A	10 mm	5
18614A	12 mm	5
18615A	13 mm	5

FESTA

ADAPTER - KOMPLET



Broj 18618
specifikacija 6, 7, 8, 9, 10, 11, 12, 13 mm



12





FESTA

KOMPLET BITOVA

- bit 25 mm S 3 · 4 · 5 · 6
- PH 0 · 1 · 2 · 3
- PZ 0 · 1 · 2 · 3
- H 3 · 4 · 5 · 6
- T 10 · 15 · 20 · 25 · 27 · 30 · 40
- TTa 10 · 15 · 20 · 25 · 27 · 30 · 40

nastavak

32x **CrV**

Broj	specifikacija	
18908		1



FESTA

KOMPLET BITOVA

- S 3 · 4 · 5 · 6
- PH 1 · 2 · 3
- PZ 1 · 2 · 3
- H 3 · 4 · 5 · 6
- T 10 · 15 · 20 · 25 · 27 · 30 · 40
- TTa 10 · 15 · 20 · 25 · 27 · 30 · 40

· nastavak za bitove brzozatezujuci

33x **1/4"** **S2**

Broj	specifikacija	
18905		10



FESTA

KOMPLET BITOVA

- S 4 · 5 · 6
- PH 1 · 2 · 3
- PZ 1 · 2 · 3
- H 3 · 4 · 5 · 6
- T 10 · 15 · 20 · 25 · 27 · 30 · 40
- TTa 10 · 15 · 20 · 25 · 27 · 30 · 40

· nastavak za bitove brzozatezujuci

57x **1/4"** **S2**

Broj	specifikacija	
18906		6

FESTA

KOMPLET BITOVA

- HTa 2 · 2.5 · 3 · 4 · 5 · 6
5/32" · 9/64" · 1/8"
7/64" · 3/32" · 5/64"
- SD 4 · 6 · 8 · 10
- TS 6 · 8 · 10
- TW 1 · 2 · 3 · 4
- TTa 8 · 10 · 15 · 20 · 25 · 27 · 30 · 35 · 40

nastavak za bitove magnetni

33x **1/4"** **S2**

Broj	specifikacija	
18900		10

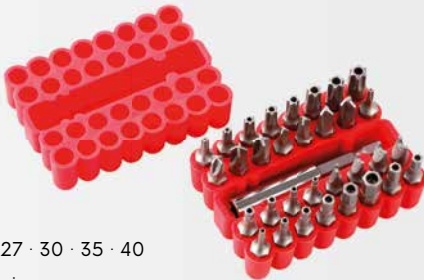

FESTA

KOMPLET BITOVA

- S 3 · 4 · 4.5 · 5 · 5.5 · 6 · 6.5 · 7 · 8
- PH 0 · 1 · 2 · 3
- PZ 0 · 1 · 2 · 3
- Q 0 · 1 · 2 · 3
- T 8 · 10 · 15 · 20 · 25 · 27 · 30 · 40 · 45
- TTa 8 · 10 · 15 · 20 · 25 · 27 · 30 · 35 · 40
- H 1.5 · 2 · 2.5 · 3 · 4 · 5 · 5.5 · 6 · 8 mm
1/16" · 5/64" · 3/32" · 7/64" · 1/8" · 9/64"
5/32" · 3/16" · 7/32" · 1/4"
- HTa 2 · 2.5 · 3 · 4 · 5 · 6 mm
5/64" · 3/32" · 7/64" · 1/8" · 9/64" · 5/32"
- SD 4 · 6 · 8 · 10
- TS 6 · 8 · 10
- TW 1 · 2 · 3 · 4
- 2-kрила 1 · 2 · 3
- ZN 5 · 6 · 8

nastavak na odvijač Y držač

1/4" DR držač bitova
1/4" bit adapter: 25mm, 50mm

100x **1/4"** **S2**

Broj	specifikacija	
18909		24



FESTA

KOMPLET BITOVA

- S 3 · 4 · 5 · 6 · 7
- PH 0 · 1 · 2 · 3
- PZ 1 · 2 · 3
- H 2 · 2.5 · 3 · 4 · 5 · 6
- T 10 · 15 · 20 · 25 · 30 · 40

nastavak za bitove magnetni

33x **1/4"** **S2**

Broj	specifikacija	
18901		10



KOMPLET BITOVA

- ⊖ S 4 · 5 · 6 · 7
- ⊕ PH 1 · 2 · 3
- ✱ PZ 1 · 2 · 3
- H 4 · 5 · 6
- ⊛ T 10 · 15 · 20 · 25
- SQ 1 · 2 · 3

20x **S2**



10x **CrV** **TiN**

Broj	specifikacija	
18907		10



KOMPLET BITOVA

- ⊖ S 4 · 5 · 6 · 7
- ⊕ PH 1 · 2 · 3
- ✱ PZ 1 · 2 · 3



10x **CrV** **TiN**

Broj	specifikacija	
18440		10

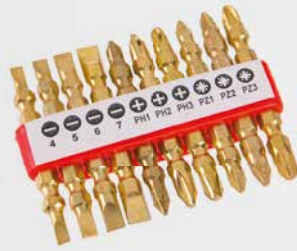

KOMPLET BITOVA

- ⊖ S 3 · 5 · 7
- ⊕ PH 1 · 2 · 3

magnetni nastavak za bit



7x **HOBBY**

Broj	specifikacija	
18430		20



KOMPLET BITOVA I NASTAVAK

- ⊕ S 3 · 3,5 · 4 · 5,5
- ✱ PH 0 · 1 · 2 · 3
- ⊖ PZ 0 · 1 · 2 · 3
- H 3 · 4
- ⊛ T 10 · 15 · 20 · 25 · 27 · 30
- 1/4" 4 · 4,5 · 5 · 5,5 · 6 · 7 · 8 · 9 · 10 · 11 · 13

nastavak na odvijač 1/4"
magnetni nastavak za bit

CrV **1/4"**

40x



Broj	specifikacija	
18915		10



SET ALATA

- ⊖ S 5 · 6 mm
- ⊕ PH 1 · 2
- H 3 · 4 · 5 · 6
- ⊛ T 15 · 20 · 25 · 30
- 1/4" 4 · 5 · 6 · 7 · 8 · 9 · 10 · 12 · 13 mm

75 mm 1/4"
 1/4" ↔ 1/4"

1/4" **CrV**

23x



Broj	specifikacija	
18421		10





FESTA
SET ALATA

122x CrV S2 1/4" 1/2" 72T

Broj specifikacija
17238 122 kom.

- 1/2", 1/4"
- 1/4" · 4-5-6-7-8-9mm
- 1/2" · 10-12-13-14-17-19mm
- 1/4" · 4-4.5-5-5.5-6-7-8-9-10-11-12-13-14mm
- 1/2" · 12-13-14-15-16-17-18-19-20-21-22-24mm
- 1/2", 1/4"
- 1/4" 1/4"
- 1/4" · 150mm
- 1/2" · 254mm
- 1/2", 1/4"
- 1/2" · 16-21mm
- 1/4" · 150mm
- 1/2" · E10-E12-E14-E16-E18-E20-E22-E24
- 1/4" S 3 · 4 · 5 · 6
- 1/4" PH 0 · 1 · 2
- 1/4" PZ 0 · 1 · 2
- 1/4"
- 1/4" · S 4 · 5,5 · 6,5
- 1/4" PH 1 · 2 · 3
- 1/4" PZ 2 · 3
- 1/4" H 3 · 4 · 5 · 6
- 1/4" T 8 · 10 · 15 · 20 · 25
- 1/4" TTa 10 · 15 · 20 · 25 · 40
- 2 · 2,5 · 3 · 4 · 5 · 6 · 7 · 8 · 10mm
- 8-9-10-11-12-13-14-15-16-17-18-19mm
- S 4x100 · 6,5x150
- PH 2x100 · 3x150
- 180mm
- 160mm
- 160mm
- 250mm
- 300g



1



SET ALATA

- 160 mm
- 160 mm
- 300 g
- 1/4" 45T
- 4 · 5 · 6 · 7 · 8 · 9 · 10 · 11 · 12 · 13 mm
- 1/4" 75 mm
- 1,5 · 2 · 2,5 · 3 · 4 · 5 · 6 · 8 · 10 mm
- S 3 · 4 · 5 · 6 mm
- PH 0 · 1 · 2 · 3
- PZ 0 · 1 · 2 · 3
- T 10 · 15 · 20 · 25
- H 3 · 4 · 5 · 6
- S 5x100 mm
- PH 1x100 · 2x100 mm
- S 2,5x50 mm
- PH 00x50 · 0x50 mm
- AC 100-250 V
- 200 mm max. 22 mm
- 10x11 · 12x13 · 14x15 · 16x17 mm
- 18 mm
- 2 m 13 mm

60x



35x

Broj specifikacija
17259

5



SET ALATA

- 120mm
- 125mm
- 115mm
- 150mm max. 19mm
- 9mm
- S 4 · 6 mm
- PH 1 · 2 · 3
- PZ 1 · 2
- H 4 · 5 · 6
- 1/4" 160mm
- 5 · 6 · 7 · 8 · 9 · 10 · 11 mm
- 1/4"
- 1/4"
- S 4 · 6 mm
- PH 1 · 2 · 3
- PZ 1 · 2
- H 4 · 5 · 6

35x

Broj specifikacija
17260



SET ALATA

- 1/4" 5 · 6 · 7 · 8 · 9 · 10 · 11 · 12 mm
- 1/4"
- 1/4"
- AC 230 V
- PH 0, SL 3
- 9x 1,5-10 mm
- 160 mm
- S 3 · 4 · 5 · 6 mm
- PH 0 · 1 · 2 · 3
- H 4 · 5
- PH 2x100, S 6x100
- 18 mm
- 1 m
- 300 g

39x



Broj specifikacija
17247

10

FESTA

10 years
guarantee



Cr-Mo

- Koristiti u industriji i servisima
- Visoka kvaliteta Chrom vanadij čelika
- Savinuta račna se 72 polirana zuba za precizan rad
- Sve komponente su prema DIN standardu
- Hrapave glave za bolje držanje, prihvat
- Čvrsti kofer s čeličnim bravama i šarkama



FESTA

KOMPLET NASADNIH KLJUČEVA

- | | | | |
|--|---|--|-----------------------------|
| | 1/2", 1/4", 3/8" | | 1/2" · 16-21mm |
| | 1/4" · 4-5-6-7-8-9-10mm | | 3/8" · 18mm |
| | 3/8" · 10-11-12-13-14-15mm | | 1/2", 1/4", 3/8" držač bita |
| | 1/2" · 16-17-18-19-22mm | | 1/2", 1/4", 3/8" |
| | 1/4" · 4-4.5-5-5.5-6-7-8-9-10-11-12-13-14mm | | 1/4" · 150mm |
| | 3/8" · 10-11-12-13-14-15-16-17-18-19mm | | 1/4" · 115mm |
| | 1/2" · 10-11-12-13-14-15-16-17-18-19-20-21-22-24-27-30-32mm | | Inbus 7X |
| | 1/4" · E4-E5-E6-E7-E8 | | |
| | 3/8" · E10-E11-E12-E14-E16-E18 | | |
| | 1/2" · E20-E24 | | |
| | 1/2" · ⊕ ⊗ ⊕ ⊗ ⊕ ⊗ ⊕ ⊗ 24x | | |
| | 1/4" · ⊕ ⊗ ⊕ ⊗ ⊕ ⊗ ⊕ ⊗ 20x | | |
| | 1/4" · ⊕ ⊗ ⊕ ⊗ ⊕ ⊗ ⊕ ⊗ 30x | | |
| | 1/4" · 50 mm, 100 mm | | |
| | 1/2" · 125 mm, 250 mm | | |
| | 3/8" · 150 mm | | |

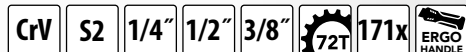

10 years
guarantee



Broj specifikacija
17237

2



FESTA

KOMPLET NASADNIH KLJUČEVA

- 1/2" · 72T
- 1/2" · 125 mm
- 1/2" · 10-11-12-13-14-15-17-19-22-24 mm

10 years guarantee

CrV 1/2" 72T 12x ERGO HANDLE

Č.p. specifikace 17245 15



FESTA

KOMPLET NASADNIH KLJUČEVA

- 1/2" · 72T
- 1/2" · 125 mm
- 1/2" · 10-11-12-13-14-15-17-19-22-24 mm

10 years guarantee

CrV 1/2" 72T 12x ERGO HANDLE

Č.p. specifikace 17229 8



FESTA

KOMPLET NASADNIH KLJUČEVA

- 1/2" · 72 T
- 1/2" · 75, 125 mm
- 1/2"
- 1/2" · 10-11-12-13-14-15-16-17-18-19-22-24 mm
- 1/2" · 17mm, 19mm
- trostrani adapter
- 16mm, 21mm

10 years guarantee

CrV 1/2" 72T 20x ERGO HANDLE

Č.p. specifikace 17230 4



FESTA

KOMPLET NASADNIH KLJUČEVA

- 1/4" · 72 T
- 1/4" · 50, 100 mm
- 1/4"
- 1/4" · 4-5-5,5-6-7-8-10-11-12-13 mm
- 1/4" · 6-7-8-10-12-13 mm
- trostrani adapter
- 4 x
- 11x
- 1x

10 years guarantee

CrV S2 1/4" 72T 36x ERGO HANDLE

Č.p. specifikace 17231 10



FESTA

KOMPLET NASADNIH KLJUČEVA

- 1/4"
- 1/4"
- 1/4" · 4-4,5-5-5,5-6-7-8-9-10-11-12-13-14 mm
- 1/4" · 50 mm, 100 mm
- 1/4"
- 1/4"
- 21 x
- 1/4"
- L 1/4"

10 years guarantee

CrV S2 1/4" 72T 45x ERGO HANDLE

Č.p. specifikace 17233 10



FESTA

KOMPLET NASADNIH KLJUČEVA

- 1/2", 1/4" · 72T
- 1/4"
- 16 mm, 21 mm
- 1/4" · 10-11-12-13-14-15-16-17-18-19-20-21-22-23-24-27 mm
- 1/4" · 100 mm
- 1/2" · 125 mm, 250 mm
- 1/4"
- 1 x
- 1/4" · 4-5-5,5-6-7-8-10-11-12-13 mm
- 33 x















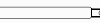

10 years guarantee

CrV S2 1/4" 1/2" 72T 73x ERGO HANDLE

Č.p. specifikace 17234 4

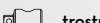
FESTA

KOMPLET NASADNIH KLJUČEVA

-  1/2", 1/4" · 72T
-  1/4"
-  16 mm, 21 mm
-  1/4" · 4 -4,5-5-5,5-6-7-8-9-10-11-12-13-14 mm
-  1/2" · 10-11-12-13-14-15-16-17-18-19-20-21-22-23-24-27-30-32 mm
-  1/4" · 6-7-8-9-10-11-12-13 mm
-  1/2" · 14-15-17-19 mm
-  1/4" · 50 mm, 100 mm
-  1/2" · 125 mm, 250 mm
-  1/4"
-  5/16" držač bita
-  17x
-  15x
-  trostrani adapter
-  3x
-  1/4"
-  L 1/4"
-  1/2", 1/4"

CrV S2 1/4" 1/2" 72T 94x ERGO HANDLE











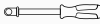







10 years guarantee

Č.p.	specifikace
17235	4

FESTA

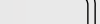
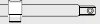
KOMPLET NASADNIH KLJUČEVA

-  1/2", 1/4" · 72T
-  150 mm
-  16 mm, 21 mm
-  1/4" · 4 -4,5-5-5,5-6-7-8-9-10-11-12-13-14 mm
-  1/2" · 10-11-12-13-14-15-16-17-18-19-20-21-22-24-27-30-32 mm
-  1/4" · 6-7-8-9-10-11-12-13 mm
-  1/2" · 14-15-17-19-22 mm
-  1/4" · 50 mm, 100 mm
-  1/2" · 125 mm, 250 mm
-  E · 4-5-6-7-8-10-11-12-14-16-18-20-24-27-30-32 mm
-  1/2", 1/4"
-  5/16" držač bita
-  18 x
-  17 x
-  trostrani adapter
-  4x
-  1/4"
-  L 1/4"

CrV S2 1/4" 1/2" 72T 110x ERGO HANDLE

























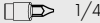
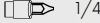
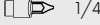
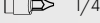
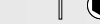
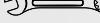
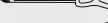

10 years guarantee

Č.p.	specifikace
17236	4

FESTA

SET ALATA

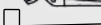
-  1/2", 1/4"
-  1/4" · 4-5-6-7-8-9mm
-  1/2" · 10-12-13-14-17-19mm
-  1/4" · 4-4,5-5-5,5-6-7-8-9-10-11-12-13-14mm
-  1/2" · 12-13-14-15-16-17-18-19-20-21-22-24mm
-  1/2", 1/4"
-  1/4"/4" → 1/4"/4"
-  1/4" · 150mm
-  1/2" · 254mm
-  1/2", 1/4"
-  1/2" · 16-21mm
-  1/4" · 150mm
-  1/2" · E10-E12-E14-E16-E18-E20-E22-E24
-  1/4" · S 3 · 4 · 5 · 6
-  1/4" · PH 0 · 1 · 2
-  1/4" · PZ 0 · 1 · 2
-  1/4" · S 4 · 5,5 · 6,5
-  1/4" · PH 1 · 2 · 3
-  1/4" · PZ 2 · 3
-  1/4" · H 3 · 4 · 5 · 6
-  1/4" · T 8 · 10 · 15 · 20 · 25
-  1/4" · TTα 10 · 15 · 20 · 25 · 40
-  2 · 2,5 · 3 · 4 · 5 · 6 · 7 · 8 · 10mm
-  8-9-10-11-12-13-14-15-16-17-18-19mm
-  S 4x100 · 6,5x150
-  PH 2x100 · 3x150
-  180mm
-  160mm
-  160mm
-  250mm
-  300g

CrV S2 1/4" 1/2" 72T 122x ERGO HANDLE



Č.p.	specifikace
17238	122 ks 1



FESTA



FESTA

Cr-Mo

RATCHET FESTA

- Ergonomska kvaliteta, dvokomponentna drška s mekanom TPE gumom
- Savinuta račna se 72 polirana zuba za precizan rad
- Savinuta račna je napravljena i z najkvalitnijeg ChromVanadij čelika
- SISTEM BRZOG OTPUŠTANJA jednostavna, brza zamjena glave

**FESTA****SAVINUTA RAČNA**

Č.p.	specifikace	délka	
17297	1/4"	155 mm	6
17298	3/8"	210 mm	5
17299	1/2"	255 mm	4

FESTA**SAVINUTA RAČNA**

Č.p.	specifikace	délka	
17240	1/4"	155 mm	10
17241	3/8"	200 mm	10
17242	1/2"	250 mm	5

FESTA**SAVINUTA RAČNA**

Č.p.	specifikace	délka	
17294	1/4"	155 mm	6
17295	3/8"	205 mm	10
17296	1/2"	255 mm	4

FESTA**RAČNA 1/4"**

Č.p.	specifikace	
17292	1/4"	1

RAČNA**HOBBY**

Č.p.	specifikace	
17243	1/4" 43T	25
17244	1/2" 39T	25

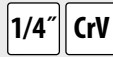
FESTA**ODVIJAČ
ZA NASADNI KLJUČ**

Č.p.	specifikace	
18603	1/4" 150 mm	10

**FESTA**

NASADNI KLJUČ 1/4"



Č.p.	specifikace	
17820	4 mm • 25 mm	10
17821	4,5 mm • 25 mm	10
17822	5 mm • 25 mm	10
17823	5,5 mm • 25 mm	10
17824	6 mm • 25 mm	10
17825	7 mm • 25 mm	10
17826	8 mm • 25 mm	10
17827	9 mm • 25 mm	10
17828	10 mm • 25 mm	10
17829	11 mm • 25 mm	10
17830	12 mm • 25 mm	10
17831	13 mm • 25 mm	10
17832	14 mm • 25 mm	10

**FESTA**

NASADNI KLJUČ 1/2"



Č.p.	specifikace	
17308	8 mm • 38 mm	10
17309	9 mm • 38 mm	10
17310	10 mm • 38 mm	10
17311	11 mm • 38 mm	10
17312	12 mm • 38 mm	10
17313	13 mm • 38 mm	10
17314	14 mm • 38 mm	10
17315	15 mm • 38 mm	10
17316	16 mm • 38 mm	10
17317	17 mm • 38 mm	10
17318	18 mm • 38 mm	10
17319	19 mm • 38 mm	10
17320	20 mm • 38 mm	10
17321	21 mm • 38 mm	10
17322	22 mm • 38 mm	10
17324	24 mm • 38 mm	10
17327	27 mm • 42 mm	20
17330	30 mm • 42 mm	25
17332	32 mm • 42 mm	20
17333	34 mm • 42 mm	20
17334	36 mm • 42 mm	20

**FESTA**

NASADNI KLJUČ 3/4"



Č.p.	specifikace	
17835	17 mm • 48 mm	10
17836	18 mm • 48 mm	10
17837	19 mm • 48 mm	10
17838	21 mm • 48 mm	10
17839	22 mm • 48 mm	10
17840	24 mm • 48 mm	10
17841	26 mm • 48 mm	10
17842	27 mm • 52 mm	10
17843	28 mm • 52 mm	10
17844	30 mm • 52 mm	10
17845	32 mm • 52 mm	10
17846	33 mm • 55 mm	10
17847	36 mm • 60 mm	10
17848	38 mm • 60 mm	10
17849	41 mm • 65 mm	10
17850	46 mm • 65 mm	10
17851	50 mm • 70 mm	10
17852	55 mm • 75 mm	10
17853	60 mm • 78 mm	10
17854	65 mm • 82 mm	10
17855	70 mm • 82 mm	10
17856	75 mm • 88 mm	10

**FESTA**NASADNI KLJUČ 1/2"
MULTILOCK

Č.p.	specifikace	
17910	8 mm • 38 mm	10
17914	12 mm • 38 mm	10
17916	14 mm • 38 mm	10
17922	21 mm • 38 mm	10
17924	24 mm • 38 mm	10
17926	30 mm • 38 mm	10

**FESTA**NASADNI KLJUČ 1/4"
PRODUŽENI

Č.p.	specifikace	
17860	4 mm • 50 mm	10
17861	5 mm • 50 mm	10
17862	6 mm • 50 mm	10
17863	7 mm • 50 mm	10
17864	8 mm • 50 mm	10
17865	9 mm • 50 mm	10
17866	10 mm • 50 mm	10
17867	11 mm • 50 mm	10
17868	12 mm • 50 mm	10
17869	13 mm • 50 mm	10
17870	14 mm • 50 mm	10

**FESTA**NASADNI KLJUČ 1/2"
PRODUŽENI

Č.p.	specifikace	
17871	10 mm • 70 mm	10
17872	11 mm • 70 mm	10
17873	12 mm • 70 mm	10
17874	13 mm • 70 mm	10
17875	14 mm • 70 mm	10
17876	15 mm • 70 mm	10
17877	16 mm • 70 mm	10
17878	17 mm • 70 mm	10
17879	18 mm • 70 mm	10
17880	19 mm • 70 mm	10
17881	20 mm • 70 mm	10
17882	21 mm • 70 mm	10
17883	22 mm • 70 mm	10
17884	23 mm • 70 mm	10
17885	24 mm • 70 mm	10
17886	25 mm • 70 mm	10
17887	26 mm • 70 mm	10
17888	27 mm • 70 mm	10
17889	28 mm • 70 mm	10
17890	30 mm • 70 mm	10
17891	32 mm • 70 mm	10
17892	34 mm • 70 mm	10

**FESTA**NASADNI KLJUČ 1/2"
TORX

Č.p.	specifikace	
17943	E22	10
17944	E24	10

**FESTA**NASADNI KLJUČ 1/4"
TORX

Č.p.	specifikace	
17930	E4	10
17934	E8	10
17935	E10	10

**FESTA**NASADNI KLJUČ 1/4"
MULTILOCK

Č.p.	specifikace	
17895	4 mm • 25 mm	10
17896	4,5 mm • 25 mm	10
17897	5 mm • 25 mm	10
17898	5,5 mm • 25 mm	10
17904	11 mm • 25 mm	10
17905	12 mm • 25 mm	10
17907	14 mm • 25 mm	10





FESTA

NASADNI KLJUČ 1/4" SA BITOM S

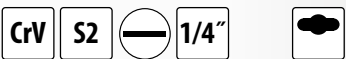

Č.p.	specifikace	
18920	S 4 mm	10
18921	S 5,5 mm	10
18922	S 7 mm	10



FESTA

NASADNI KLJUČ 1/4" SA BITOM PH



Č.p.	specifikace	
18925	PH 1	10
18926	PH 2	10
18927	PH 3	10



FESTA

NASADNI KLJUČ 1/4" SA BITOM PZ



Č.p.	specifikace	
18928	PZ 0	10
18929	PZ 1	10
18930	PZ 2	10
18931	PZ 3	10



FESTA

NASADNI KLJUČ 1/2" SA BITOM TORX



Č.p.	specifikace	
18954	T 10	10
18955	T 15	10
18956	T 20	10
18960	T 40	10
18961	T 45	10
18963	T 55	10



FESTA

NASADNI KLJUČ 1/4" SA BITOM TORX



Č.p.	specifikace	
18948	T 5	10
18950	T 8	10
18951	T 10	10



FESTA

NASADNI KLJUČ 1/4" SA BITOM H (IMBUS)



Č.p.	specifikace	
18934	3 mm	10
18939	8 mm	10



FESTA

NASADNI KLJUČ 1/2" SA BITOM XZN



Č.p.	specifikace	
18971	M 16	10



FESTA

KLIZAČ ZA KLIZNU POLUGU „T“

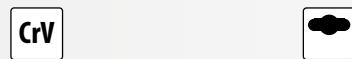

Č.p.	specifikace	
17420	1/4"	1
17421	1/2"	1
17422	3/4"	1



FESTA

ADAPTER



Č.p.	specifikace	
17410	A - 1/4" B - 3/8"	10
17411	A - 3/8" B - 1/4"	10
17412	A - 3/8" B - 1/2"	10
17413	A - 1/2" B - 3/8"	10
17414	A - 1/2" B - 3/4"	10
17415	A - 3/4" B - 1/2"	10
17416	A - 1/4" B - 1/2"	10



FESTA

PRODUŽNI NASTAVAK

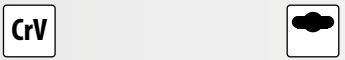

Č.p.	specifikace	
17390	1/4" • 50 mm	1
17391	1/4" • 100 mm	1
17392	1/4" • 150 mm	1
17393	1/2" • 75 mm	1
17394	1/2" • 125 mm	1
17395	1/2" • 250 mm	1
17396	3/4" • 100 mm	1
17397	3/4" • 200 mm	1
17398	3/4" • 400 mm	1



FESTA

ZGLOBNI NASTAVAK

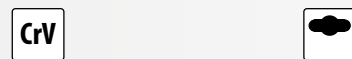

Č.p.	specifikace	
17405	1/4" • 39 mm	10
17406	1/2" • 71 mm	10
17407	3/4" • 105 mm	10

FESTA

KLIZNA POLUGA „T“



Č.p.	specifikace	
17382	1/4" • 115 mm	1
17383	3/8" • 190 mm	1
17384	1/2" • 250 mm	1
17385	3/4" • 460 mm	1
17386	1" • 640 mm	1



FESTA

T" PRODUŽNI ZGLOBNI NASTAVAK

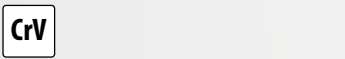

Č.p.	specifikace	
17401	1/4" • 250 mm	1
17402	1/2" • 400 mm	1





FESTA
ZGLOBNA POLUGA

Broj	specifikacija	MOQ
17380	1/2" • 350 mm	1
17381	3/4" • 500 mm	1



FESTA
„L“ POLUGA

Broj	specifikacija	MOQ
17427	1/2" • 60 x 320 mm	1



FESTA
PRODUŽNI NASTAVAK FLEX

Broj	specifikacija	MOQ
17400	1/4" • 150 mm	1

Stahlberg
ADAPTER
RAČNA 1/4" - BIT

Broj	specifikacija	MOQ
18619	1/4" ↔ 1/4"	5



UNIVERZALNI
NASADNI KLJUČ

Broj	Specifikacija	MOQ
17812	10 - 19 mm	1



UNIVERZALNI NASADNI KLJUČ

Broj	specifikacija	MOQ
17810	veličina 7 - 19mm • 52mm x ø26mm	1



UNIVERZALNI NASADNI KLJUČ

Broj	specifikacija	MOQ
17811	veličina 11 - 32mm • 83mm x ø43mm	5



KOMPLET KLJUČEVA DRIVELOCK

Č.p.	specifikacija	MOQ
17250	4-5-5,5-6-7-8-9-10-11-12-13 mm	10



KOMPLET NASADNIH KLJUČEVA TORX

Č.p.	specifikacija	MOQ
17255	1/4" • 5-6-7-8-10 1/2" • 12-14-16-18	4



KOMPLET ADAPTERA
ZA BUŠILICU

Broj	specifikacija	MOQ
18604	1/4", 3/8", 1/2"	10



UNIVERZALNI
KLJUČ ZA RADIJATORE

Broj	specifikacija	MOQ
17455	za račnu 1/2"	10

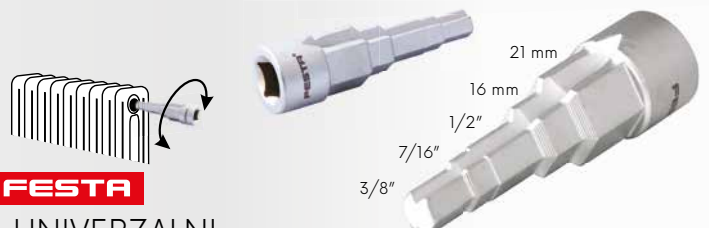

NEW



FESTA

KOMPLET "T" ODVIJAČA - INBUS + TORX

- H 2.5 · 3 · 4 · 5 · 6 · 8 · 10 mm
- ★ T 10 · 15 · 20 · 25 · 30 · 40 · 45

14x CrV

Broj	specifikacija	
18501		1

FESTA

KOMPLET "T" ODVIJAČA

- 2 mm
- 2,5 mm
- 3 mm
- 4 mm
- 5 mm
- 6 mm
- 7 mm
- 8 mm
- 10 mm

9x CrV

Broj	specifikacija	
18494		6



FESTA

"T" ODVIJAČ TORX

★ CrV



Broj	specifikacija		Broj	specifikacija	
17350	T 7	10	17357	T 27	10
17351	T 8	10	17359	T 40	10
17352	T 9	10	17361	T 50	10
17353	T 10	10			

FESTA

KOMPLET "T" ODVIJAČA - TORX

- T 10
- T 15
- T 20
- T 25
- T 27
- T 30
- T 40
- T 45
- T 50

9x CrV

Broj	specifikacija	
18495		6



FESTA

KLJUČ IMBUS - STANDARD

DIN 911 CrV

Č.p.	specifikacije	
18567	27 mm 100 x 250 mm	1
18572	32 mm 125 x 315 mm	1

FESTA

KLJUČ IMBUS - PRODUŽENI

CrV

Č.p.	specifikacije	
18510	1,5 mm 14 x 74 mm	1
18511	2 mm 16 x 81 mm	1
18512	2,5 mm 18 x 88 mm	1
18513	3 mm 23 x 108 mm	1
18514	4 mm 24 x 107 mm	1
18515	5 mm 23 x 118 mm	1
18516	6 mm 32 x 135 mm	1
18518	8 mm 36 x 153 mm	1
18519	9 mm 38 x 155 mm	1
18520	10 mm 40 x 168 mm	1
18521	11 mm 40 x 230 mm	1
18522	12 mm 45 x 237 mm	1
18523	13 mm 45 x 260 mm	1
18524	14 mm 55 x 265 mm	1
18527	17 mm 60 x 298 mm	1

FESTA

KLJUČ IMBUS SA GLAVOM PRODUŽENI

CrV

Č.p.	specifikacije	
18575	1,5 mm 15 x 75 mm	1
18576	2 mm 17 x 81 mm	1
18577	2,5 mm 18 x 87 mm	1
18578	3 mm 20 x 96 mm	1
18579	4 mm 24 x 107 mm	1
18580	5 mm 30 x 120 mm	1
18581	6 mm 33 x 136 mm	1
18582	7 mm 34 x 144 mm	1
18583	8 mm 36 x 153 mm	1
18584	9 mm 38 x 155 mm	1
18585	10 mm 40 x 168 mm	1
18587	12 mm 45 x 237 mm	1
18588	13 mm 45 x 210 mm	1
18589	14 mm 55 x 265 mm	1
18593	17 mm 60 x 298 mm	1

FESTA

KLJUČ TORX

★ CrV

Č.p.	specifikacije	
18476	T45	1

FESTA

KOMPLET IMBUSA

- H 1,5 mm
- H 2 mm
- H 2,5 mm
- H 3 mm
- H 4 mm
- H 5 mm
- H 6 mm
- H 8 mm
- H 10 mm



Broj	specifikacija	
18496		5

FESTA

KOMPLET IMBUSA SA GLAVOM

- H 1,5 mm
- H 2 mm
- H 2,5 mm
- H 3 mm
- H 4 mm
- H 5 mm
- H 6 mm
- H 8 mm
- H 10 mm



Broj	specifikacija	
18500		5

FESTA

KOMPLET IMBUSA - PRODUZEN

- H 1,5 mm
- H 2 mm
- H 2,5 mm
- H 3 mm
- H 4 mm
- H 5 mm
- H 6 mm
- H 8 mm
- H 10 mm



Broj	specifikacija	
18490		5

FESTA

KOMPLET IMBUSA SA GLAVOM

- H 1,5 mm
- H 2 mm
- H 2,5 mm
- H 3 mm
- H 4 mm
- H 5 mm
- H 6 mm
- H 8 mm
- H 10 mm



Broj	specifikacija	
18498		5

FESTA

KOMPLET IMBUSA SA GLAVOM

- 1/16"
- 5/64"
- 3/32"
- 1/8"
- 5/32"
- 3/16"
- 1/4"
- 5/16"
- 3/8"



Broj	specifikacija	
18493		6

FESTA

KOMPLET IMBUSA TORX

- T 10 mm
- T 15 mm
- T 20 mm
- T 25 mm
- T 27 mm
- T 30 mm
- T 40 mm
- T 45 mm
- T 50 mm



Broj	specifikacija	
18497		5

FESTA

KOMPLET IMBUSA SA GLAVOM - PRODUZEN

- H 1,5 mm
- H 2 mm
- H 2,5 mm
- H 3 mm
- H 4 mm
- H 5 mm
- H 6 mm
- H 8 mm
- H 10 mm



Broj	specifikacija	
18492		10

FESTA

KOMPLET IMBUSA TORX - PRODUZENI

- T 10 mm
- T 15 mm
- T 20 mm
- T 25 mm
- T 27 mm
- T 30 mm
- T 40 mm
- T 45 mm
- T 50 mm



Broj	specifikacija	
18491		5

FESTA

KOMPLET IMBUSA



R. s.	leirás	
18508	1,5 · 2 · 2,5 · 3 · 4 · 5 · 6 mm	1



KOMPLET IMBUSA



Broj	specifikacija	
18499	2 · 2,5 · 3 · 4 · 5 · 6 · 8 · 10 mm	1



FESTA

KLJUČ OBOSTRANI
VILIČASTI

CrV DIN 3110



Broj	specifikacija	
17550	6 x 7 mm	10
17551	8 x 9 mm	10
17552	8 x 10 mm	10
17553	10 x 11 mm	10
17590	10 x 13 mm	10
17554	12 x 13 mm	10
17555	14 x 15 mm	10
17556	13 x 16 mm	10
17557	13 x 17 mm	10
17591	14 x 17 mm	10
17558	16 x 17 mm	10
17559	17 x 19 mm	10
17560	18 x 19 mm	10

Broj	specifikacija	
17592	19 x 22 mm	10
17593	19 x 24 mm	10
17561	20 x 22 mm	10
17569	21 x 23 mm	10
17548	22 x 24 mm	10
17562	24 x 27 mm	10
17549	24 x 30 mm	10
17563	30 x 32 mm	10
17564	30 x 34 mm	10
17565	32 x 36 mm	10
17566	36 x 41 mm	10
17567	46 x 50 mm	10
17568	50 x 55 mm	3

FESTA

KLJUČ
KOMBINIRANI

CrV DIN 3113



Broj	specifikacija	
17487	6 mm	10
17570	7 mm	10
17571	8 mm	10
17572	9 mm	10
17573	10 mm	10
17574	11 mm	10
17575	12 mm	10
17576	13 mm	10
17577	14 mm	10
17578	15 mm	10
17579	16 mm	10
17580	17 mm	10
17581	18 mm	10
17582	19 mm	10
17488	20 mm	10

Broj	specifikacija	
17489	21 mm	10
17583	22 mm	10
17490	23 mm	10
17584	24 mm	10
17491	25 mm	10
17492	26 mm	10
17585	27 mm	10
17493	28 mm	10
17494	29 mm	10
17586	30 mm	10
17587	32 mm	10
17495	33 mm	10
17496	34 mm	10
17589	36 mm	10

FESTA

KLJUČEVI OKASTO-VILJUŠKASTI
ZGLOBNI

CrV 72T



Broj	specifikacija	
17628	8 mm	10
17622	10 mm	10
17623	13 mm	10
17624	14 mm	10
17629	15 mm	10
17630	16 mm	5

Broj	specifikacija	
17625	17 mm	10
17631	18 mm	10
17626	19 mm	10
17632	21 mm	5
17633	22 mm	5

FESTA

KLJUČ -
RAČNA

CrV 72T



Broj	specifikacija	
17660	6 mm	10
17676	7 mm	10
17661	8 mm	10
17662	9 mm	10
17663	10 mm	10
17664	11 mm	10
17665	12 mm	10
17666	13 mm	10
17667	14 mm	10
17668	15 mm	10

Broj	specifikacija	
17669	16 mm	10
17670	17 mm	10
17671	18 mm	10
17672	19 mm	10
17674	21 mm	5
17675	22 mm	5
17677	24 mm	5
17678	27 mm	5
17679	30 mm	5
17683	32 mm	5

FESTA

KLJUČ
OBOSTRANI
VILIČASTI

DIN 895



Broj	specifikacija	
17460	6 x 7 mm	10
17461	8 x 9 mm	10
17462	8 x 10 mm	10
17463	10 x 11 mm	10
17481	10 x 13 mm	10
17464	12 x 13 mm	10
17465	14 x 15 mm	10
17467	13 x 17 mm	10
17482	14 x 17 mm	10
17468	16 x 17 mm	10

Broj	specifikacija	
17469	17 x 19 mm	10
17470	18 x 19 mm	10
17483	19 x 22 mm	10
17484	19 x 24 mm	10
17471	20 x 22 mm	10
17472	24 x 27 mm	10
17486	21 x 23 mm	10
17480	28 x 30 mm	10
17473	30 x 32 mm	10
17485	36 x 41 mm	10

FESTA

OBOSTRANI
OKASTI KLJUČ

CrV DIN 838



Broj	specifikacija	
17605	6 x 7 mm	10
17606	8 x 9 mm	10
17607	8 x 10 mm	10
17608	10 x 11 mm	10
17609	12 x 13 mm	10
17611	13 x 16 mm	10
17612	13 x 17 mm	10

Broj	specifikacija	
17610	14 x 15 mm	10
17613	16 x 17 mm	10
17614	18 x 19 mm	10
17615	20 x 22 mm	10
17616	24 x 27 mm	10
17617	30 x 32 mm	10

FESTA

KLJUČ OBOSTRANI
VILIČASTI

CrV DIN 3110



Broj	specifikacija	
17761	14 x 15 mm	10
17769	20 x 22 mm	10

FESTA

KLJUČ
KOMBINIRANI

CrV DIN 3113



Broj	specifikacija	
17788	14 mm	10
17795	21 mm	10
17806	33 mm	10

FESTA**KLJUČ - RAČNA
KOMPLET**

8-9-10-11-12-13-14-15-16-17-18-19 mm

CrV**72T**

Broj

specifikacija

17619

1

**NEW****FESTA****KLJUČ****Cr-Mo**

Broj

specifikacija

17685

12-13-14-15-16-17-18-19 mm

1

12-13-14-15 mm



16-17-18-19 mm

FESTA**GRAĐEVINSKI KLJUČ****CrV**

Broj

rozsah

délka

17197

0 - 29 mm

200 mm

1

17198

0 - 33 mm

250 mm

1

17199

0 - 38 mm

300 mm

1

**GRAĐEVINSKI KLJUČ**

Broj

rozsah

délka

17200

0 - 24 mm

200 mm

6

17201

0 - 30 mm

250 mm

6

17202

0 - 34 mm

300 mm

6

**FESTA****FESTA****FESTA****KLJUČ OBOSTRANI
VILIČASTI - KOMPLET****CrV****DIN 3110**

Broj

specifikacija

17506

6 kom · 6 x 7, 8 x 9, 10 x 11,
12 x 13, 14 x 15, 16 x 17

1

17508

8 kom · 6 x 7, 8 x 9, 10 x 11,
12 x 13, 14 x 15, 16 x 17,
18 x 19, 20 x 22

1

**FESTA****KLJUČ KOMBINIRANI
- KOMPLET****CrV****DIN 3113**

Broj

specifikacija

17526

6 kom · 10 x 10, 11 x 11, 13 x 13,
14 x 14, 16 x 16, 17 x 17

1

17528

8 kom · 8 x 8, 10 x 10, 11 x 11,
13 x 13, 14 x 14, 16 x 16,
17 x 17, 19 x 19

1

**FESTA****OKASTI KLJUČEVI
KOMPLETI****8x****CrV****DIN 838**

Broj

specifikacija

17539

6 x 7, 8 x 9, 10 x 11, 12 x 13, 14 x 15,
16 x 17, 18 x 19, 20 x 22

1



FESTA**KLJUČ KOMBINIRANI -
KOMPLET****CrV****DIN 3113**

Broj	specifikacija	
17532	12 kom · 8 x 8, 9 x 9, 10 x 10, 11 x 11, 13 x 13, 14 x 14, 16 x 16, 17 x 17, 18 x 18, 19 x 19, 21 x 21, 22 x 22	10
17533	18 kom · 6 x 6, 7 x 7, 8 x 8, 9 x 9, 10 x 10, 11 x 11, 12 x 12, 13 x 13, 14 x 14, 15 x 15, 16 x 16, 17 x 17, 18 x 18, 19 x 19, 20 x 20, 21 x 21, 22 x 22, 24 x 24	1
17534	25 kom · 6 x 6, 7 x 7, 8 x 8, 9 x 9, 10 x 10, 11 x 11, 12 x 12, 13 x 13, 14 x 14, 15 x 15, 16 x 16, 17 x 17, 18 x 18, 19 x 19, 20 x 20, 21 x 21, 22 x 22, 23 x 23, 24 x 24, 25 x 25, 26 x 26, 27 x 27, 28 x 28, 30 x 30, 32 x 32	4

FESTA**KLJUČ RAČNA - KOMPLET****CrV****7x**

Broj	specifikacija	
17620	8, 10, 12, 13, 14, 17, 19	5

FESTA**KLJUČ RAČNA, ZGLOBNI - KOMPLET****CrV****7x**

Broj	specifikacija	
17621	10, 12, 13, 14, 15, 17, 19	5

FESTA**KLJUČ OBOSTRANI
VILIČASTI - KOMPLET****CrV****DIN 3110****12x**

Broj	specifikacija	
17512	6 x 7, 8 x 9, 10 x 11, 12 x 13, 14 x 15, 16 x 17, 18 x 19, 20 x 22, 21 x 23, 24 x 27, 25 x 28, 30 x 32	1

FESTA**KOMPLET CIJEVASTIH KLJUČEVA****CrV****7x**

Broj	specifikacija	
17501	6 x 7, 8 x 9, 10 x 11, 12 x 13, 14 x 15, 16 x 17, 18 x 19	20
17640	ručka za cijevaste ključeve · 135 mm	50

FESTA**KLJUČ VILIČASTI -
KOMPLET DIN 895****DIN 895**

Broj	specifikacija	
17475	8 kom · 6 x 7, 8 x 9, 10 x 11, 12 x 13, 14 x 15, 16 x 17, 18 x 19, 20 x 22	5
17476	12 kom · 6 x 7, 8 x 9, 10 x 11, 12 x 13, 14 x 15, 16 x 17, 18 x 19, 20 x 22, 21 x 23, 24 x 27, 28 x 30, 30 x 32	3

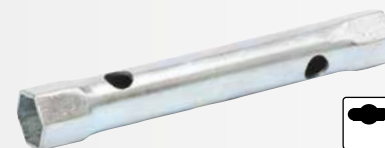
FESTA**CIJEVASTI KLJUČ****CrV**

Broj	specifikacija		Broj	specifikacija	
17650	6 x 7 mm	10	17655	16 x 17 mm	10
17651	8 x 9 mm	10	17645	16 x 18 mm	10
17642	8 x 10 mm	10	17653	16 x 21 mm	10
17652	10 x 11 mm	10	17656	18 x 19 mm	10
17643	12 x 13 mm	10	17657	19 x 22 mm	10
17654	14 x 15 mm	10	17659	22 x 24 mm	10
17644	14 x 17 mm	10	17658	24 x 27 mm	10

**KLJUČ ZA KUTNU BRUSILICU - PRILAGODLJIV**

Broj	specifikacija	
20967	200 mm	15

**KLJUČ ZA KUTNU BRUSILICU**

Broj	specifikacija	
20968	200 mm	1

FESTA

KLJUČ ZA MONTAŽU SKELA



Broj	specifikacija	
17452	19 x 22 mm	2

**FESTA**

KLJUČ ZA MONTAŽU SKELA

Broj	specifikacija	
17451	18 mm	10
17450	19 mm	10

**FESTA**

MOMENT KLJUČ

Broj	specifikacija	
17203	1/4" 5 - 25 Nm	1
17204	1/2" 19 - 110 Nm	1
17205	1/2" 42 - 210 Nm	1
17206	3/4" 140 - 700 Nm	1

**FESTA**made by **HENITON**

KOMPLET NASADNIH KLJUČEVA

Cr-Mo 1/2" 3x

Č.p.	specifikace	
17338	21 mm	5

MONTAŽNI AUTO KLJUČ



Broj	specifikacija	
17600	17, 19, 22 mm, 13/16"	16

MONTAŽNI AUTO KLJUČ



Broj	specifikacija	
17601	17, 19, 21 mm	20

TELESKOPSKI KLJUČ ZA KOTAČE



Broj	specifikacija	
17603	17 x 19 mm, 21 x 23 mm	20

KLJUČ ZA SVIJEĆICE



Broj	specifikacija	
17261	16 mm	1
17262	21 mm	1

FESTA

KLJUČ ZA ZATEZANJE

CrV



Broj	specifikacija		
17680	19 - 51 mm	165 mm	5
17681	32 - 76 mm	216 mm	5
17682	51 - 121 mm	267 mm	5

DVOKRAKI IZVLAKAČ



Broj	max. Ø	dubina	
23734	Ø 100 mm	50-95 mm	1
23735	Ø 150 mm	100-150 mm	1
23736	Ø 200 mm	110-190 mm	1

TRKOKRAKI IZVLAKAČ



Broj	max. Ø	dubina	
23730	Ø 100 mm	50-95 mm	2
23731	Ø 150 mm	100-150 mm	2
23732	Ø 200 mm	110-190 mm	2

FESTA

UNIVERZALNI KLJUČ ZA RADIJATORE

CrV 1/2"

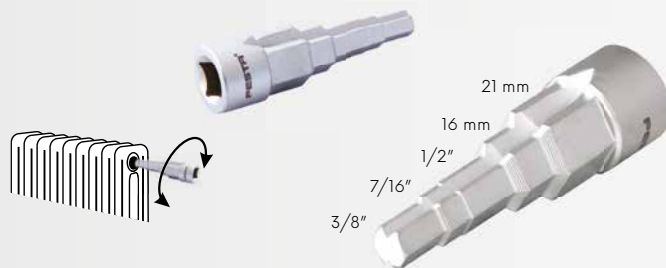

Broj	specifikacija	
17455	za račnu 1/2"	10



KLJUČ ZA ODZRAČIVANJE RADIJATORA

2x



Broj	specifikacija	
17454	5 x 5 mm	1

KLJUČ ZA ODZRAČIVANJE RADIJATORA SA SPREMIKOM



Broj	specifikacija	
17459	50 ml	1



FESTA

VIŠENAMJENSKI KLJUČ

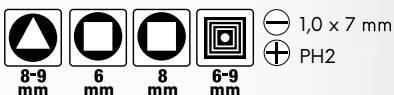

Broj	specifikacija	
17458		1

FESTA

VIŠENAMJENSKI KLJUČ

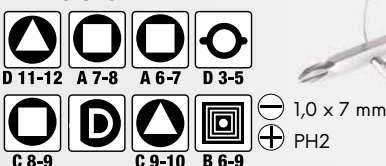

Broj	specifikacija	
17456		50



KLJIJEŠTA KOMBINIRANA

DIN 5746	TUV GS	Broj	specifikacija	
CrV	HRC 58-62	17101	160 mm	6
		17102	180 mm	6
		17103	200 mm	6



KLJIJEŠTA SJEKAĆA

DIN 5749	TUV GS	CrV	HRC 58-62	ERGO HANDLE	Broj	specifikacija	
					17148	180 mm	6



KLJIJEŠTA SJEKAĆA

DIN 5749	TUV GS	CrV	HRC 58-62	ERGO HANDLE	Broj	specifikacija	
					17104	160 mm	6
					17105	180 mm	6



KLJIJEŠTA RADIO

DIN 5745	TUV GS	CrV	HRC 58-62	ERGO HANDLE	Broj	specifikacija	
					17140	160 mm	6
					17142	200 mm	6



KLJIJEŠTA RADIO SAVIJENA

DIN 5749	TUV GS	CrV	HRC 58-62	ERGO HANDLE	Broj	specifikacija	
					17145	160 mm	6
					17146	200 mm	6



FESTA



**FESTA**

KLJIJEŠTA KOMBINIRANA

DIN 5746				
Broj	specifikacija			
17001	160 mm	6		
17002	180 mm	6		
17003	200 mm	6		

**FESTA**

KLJIJEŠTA SJEKAČA

DIN 5749				
Broj	specifikacija			
17004	160 mm	6		
17005	180 mm	6		

**FESTA**

KLJIJEŠTA SJEKAČA HEAVY DUTY

DIN 5749				
Broj	specifikacija			
17108	180 mm	6		

**FESTA**

KLJIJEŠTA SJEKAČA

DIN 5748				
Broj	specifikacija			
17110	160 mm	6		

**FESTA**

KLJIJEŠTA RADIO RAVNA

DIN 5745				
Broj	specifikacija			
17006	160 mm	6		
17011	200 mm	6		

**FESTA**

KLJIJEŠTA RADIO SAVIJENA

DIN 5745				
Broj	specifikacija			
17007	160 mm	6		
17008	200 mm	6		

**FESTA**

KLJIJEŠTA RAVNA

DIN 5746				
Broj	specifikacija			
17009	160 mm	6		

**FESTA**

KLJIJEŠTA OKA

DIN 5745			
Broj	specifikacija		
17010	160 mm	6	

**FESTA**

KLJIJEŠTA ZA SKIDANJE IZOLACIJE

DIN 5744			
Broj	specifikacija		
17024	160 mm	6	



KLJIJEŠTA KOMBINIRANA

DIN 5746		
Broj	specifikacija	
17094	160 mm	6
17095	180 mm	6
17096	200 mm	6



KLJIJEŠTA SJEKAČA

DIN 5749		
Broj	specifikacija	
17097	160 mm	6
17098	180 mm	6



KLJIJEŠTA RADIO RAVNA

DIN 5745		
Broj	specifikacija	
17099	160 mm	6
17100	200 mm	6

FESTA
INDUSTRY

VDE KLIJEŠTA KOMBINIRANA

 ⚡ 1000 V ⚡
IEC/EN60900:2004

DIN 5746 CrV HRC 58-62

Broj	specifikacija	
17125	160 mm	6
17126	180 mm	6
17127	200 mm	6

FESTA
INDUSTRY

VDE KLIJEŠTA SJEKAČA

 ⚡ 1000 V ⚡
IEC/EN60900:2004

DIN 5749 CrV HRC 58-62

Broj	specifikacija	
17128	160 mm	6

FESTA
INDUSTRY

VDE KLIJEŠTA ZA ŽICU

 ⚡ 1000 V ⚡
IEC/EN60900:2004

CrV HRC 58-62

Broj	specifikacija	
17130	160 mm	6

FESTA
INDUSTRY

VDE KLIJEŠTA RADIO

 ⚡ 1000 V ⚡
IEC/EN60900:2004

DIN 5745 CrV HRC 58-62

Broj	specifikacija	
17133	160 mm	6

FESTA
INDUSTRY

VDE KLIJEŠTA RADIO SAVIJENA

 ⚡ 1000 V ⚡
IEC/EN60900:2004

DIN 5745 CrV HRC 58-62

Broj	specifikacija	
17135	160 mm	6

FESTA
INDUSTRY

VDE KLIJEŠTA OKA

 ⚡ 1000 V ⚡
IEC/EN60900:2004

DIN 5745 CrV HRC 58-62

Broj	specifikacija	
17137	160 mm	6

FESTA
INDUSTRY

**VDE KLIJEŠTA
ZA SKIDANJE IZOLACIJE**

 ⚡ 1000 V ⚡
IEC/EN60900:2004

CrV DIN 5744

Broj	specifikacija	
17138	160 mm	6

FESTA
**KLIJEŠTA SJEKAČA
ZA FINE KABLOVE**

max Ø 0,2 - 2,1 mm

CrV	Broj	specifikacija	
	17047	140 mm	10

FESTA
**KLIJEŠTA SJEKAČA
ZA FINE KABLOVE**

 0,75; 1,0; 1,5; 2,5; 4,0; 6,0mm²

CrV	Broj	specifikacija	
	17087	145 mm	1

FESTA
**AUTOMATSKA KLIJEŠTA
ZA SKIDANJE IZOLACIJE**

 0,5 - 6 mm²
190 mm

Broj	specifikacija	
17178		1

**AUTOMATSKA KLIJEŠTA
ZA SKIDANJE IZOLACIJE**

 Broj specifikacija
17180 Ø 0,75 - 2,5 mm

Broj	specifikacija	
17180	Ø 0,75 - 2,5 mm	12

**KLIJEŠTA ZA SKIDANJE
IZOLACIJE**

 Broj specifikacija
17181 Ø 0,60 - 2,6 mm

Broj	specifikacija	
17181	Ø 0,60 - 2,6 mm	10

NEW



FESTA

SKIDAČ IZOLACIJE

AWG	mm ²
10	6,0
12	4,0
14	2,5
16	1,5
18	1,0
20	0,5

- RG6/59 koaksijalni kabel
- niskonaponski kabel Ø 8 - 13 mm

FESTA

SKIDAČ IZOLACIJE

· Ø 0,2-4 mm

Broj	Specifikacija
16205	125 mm



1



10



- AWG 22-18/16-14/12-10
- DIN 0,5-1,0/1,5-2,5/4-6mm²

- AWG 20-16/16-14/12-10/8
- DIN 0,5-1,0/1,5-2,5/4-6/10mm²

- AWG 20-18/16-14/12-10
- DIN 0,5-1,0/1,5-2,5/4-6mm²

- AWG 20/18/17/16/14/12
- DIN 0,5/0,75/1,0/1,5/2,5/4,0mm²

- AWG 10/8/6
- DIN 6/10/16mm²

FESTA
INDUSTRY

KLIJEŠTA ZA STEZANJE POLUGE

6x

Broj	Specifikacija
18445	



1

NEW



FESTA
INDUSTRY

KLIJEŠTA ZA STEZANJE POLUGE

Broj	Specifikacija
16206	



1



- AWG 10-22
- 0,5-0,6mm²

- AWG 10-22
- 0,5-0,6mm²

- AWG 10-22
- 0,5-0,6mm²

- skidanje izolacije
- AWG 10-24
- 0,2-0,6mm²

NEW



FESTA
INDUSTRY

KLIJEŠTA ZA STEZANJE POLUGE

Broj	Specifikacija
16208	



1



- 1,5; 2,5; 6,0mm²

- 1,5; 2,5; 6,0mm²

- skidanje izolacije
- 0,75; 1,0; 1,5; 2,5; 4,0; 6,0mm²

- rezanje vijaka
- M2,6; M3; M3,5; M4; M5

NEW



FESTA

VIŠEMAMJENSKI ALAT DŽEPNI

9 funkcija torba

CrV

Broj	specifikacija	
16232		12



FESTA

KLIJEŠTA MINI KOMPLET

4x

Broj	specifikacija	
17040		6



FESTA

KLIJEŠTA KOMBINIRANA MINI

Broj	specifikacija	
17041	110 mm	12



FESTA

KLIJEŠTA SJEKAČA MINI

Broj	specifikacija	
17042	110 mm	12



FESTA

KLIJEŠTA SJEKAČA MINI

Broj	specifikacija	
17043	100 mm	12



FESTA

KLIJEŠTA RADIO MINI

Broj	specifikacija	
17044	120 mm	12



FESTA

KLIJEŠTA OKA MINI

Broj	specifikacija	
17045	120 mm	12



KLIJEŠTA ZA SEGER PRSTENOVE

Broj	specifikacija	
17025	komplet	10



FESTA

KLIJEŠTA ZA SEGER PRSTENOVE

Broj	specifikacija	
17190	180 mm unutarnji	6
17191	180 mm vanjski	6



FESTA

KLIJEŠTA ZA SEGER PRSTENOVE

Broj	specifikacija	
17192	180 mm unutarnji	15
17193	180 mm vanjski	15



FESTA**KLIJEŠTA
VIŠENAMJENSKA**

for fence

CrV

Broj	specifikacija
17109	270 mm

**KLIJEŠTA STEZNA**

Č.p.	Specifikace		
17150	220 mm	1	

**KLIJEŠTA STEZNA**

Č.p.	Specifikace		
17151	225 mm	1	

**KLIJEŠTA STEZNA**

Č.p.	specifikace		
17034	220 mm	5	



max. 70mm

FESTA**KLIJEŠTA STEZNA**

Č.p.	specifikace		
17036	270 mm	5	

**KLIJEŠTA STEZNA**

Č.p.	specifikace		
17035	220 mm	10	

**FESTA****KLIJEŠTA STEZNA**

Č.p.	specifikace		
17023	220 mm	6	

FESTA**PODESIVA KLIJEŠTA 45°, S****CrV**

Broj	specifikacija	
17067	1" 330 mm	1
17068	1,5" 420 mm	1
17069	2" 540 mm	1

**FESTA****PODESIVA KLIJEŠTA****FESTA****PODESIVA KLIJEŠTA 90°****CrV**

Broj	specifikacija	
17075	1" 330 mm	1
17076	1,5" 420 mm	1
17077	2" 540 mm	1

**CrV**

Broj	specifikacija	
17063	230 mm	6
17064	300 mm	6

FESTA**PODESIVA KLIJEŠTA 90°****CrV**

Broj	specifikacija	
17070	2,5" 355 mm	12
17071	3" 455 mm	8
17072	3,5" 610 mm	10

**PODESIVA KLIJEŠTA**

Broj	specifikacija	
17065	260 mm	36
17066	300 mm	36

FESTA

KLIJEŠTA SIKO



CrV



Broj	specifikacija	opseg čeljusti	
16500	180 mm	0 - 40 mm	1
16501	250 mm	0 - 52 mm	1
16502	300 mm	0 - 68 mm	1

FESTA

KLIJEŠTA SIKO



CrV



Broj	specifikacija	opseg čeljusti	
17059	180 mm	0 - 30 mm	6
17061	250 mm	0 - 30 mm	6
17062	300 mm	0 - 40 mm	6
17080	400 mm	0 - 84 mm	4

FESTA

KLIJEŠTA SIKO



CrV



Broj	specifikacija	opseg čeljusti	
17084	250 mm	0 - 30 mm	6

FESTA

KLIJEŠTA SIKO



CrV



· veliki raspon čeljusti

Broj	specifikacija	opseg čeljusti	
17086	250 mm	0 - 50 mm	6

FESTA

KLIJEŠTA SIKO



CrV



Broj	specifikacija	opseg čeljusti	
17081	180 mm	0 - 30 mm	6
17014	250 mm	0 - 30 mm	6
17082	300 mm	0 - 50 mm	6

FESTA

KLIJEŠTA SIKO



CrV



Broj	specifikacija	opseg čeljusti	
17079	250 mm	0 - 50 mm	6

FESTA

KLIJEŠTA SIKO



CrV



Broj	specifikacija	opseg čeljusti	
17012	250 mm	0 - 40 mm	6
17060	300 mm	0 - 50 mm	10

KLIJEŠTA SIKO



CrV



Broj	specifikacija	opseg čeljusti	
17013	250 mm	0 - 30 mm	6
17033	300 mm	0 - 50 mm	6

PLASTIČNE NAVLAKE ZA ČELJUST SIKO KLIJEŠTA

· pogodno za 17061, 17079



Broj	specifikacija	
17085	1 pair	1

FESTA

KLIJEŠTA ZA ŽICU

- čelična žica
- ACSR kabel
- avio kabel

CrV

max. Ø 6 mm



Č.p.	specifikace	
17029	200 mm	6

FESTA

KLIJEŠTA ZA ŽICU

- čelična žica
- ACSR kabel
- avio kabel

CrV

max. Ø 12 mm



Č.p.	specifikace	
17039	24' 610 mm	8

**FESTA****KLIJEŠTA SJEKAČA****Cr-Mo**

Broj	specifikacija		
17049	18' 450 mm	max. 6 mm < 40 HRC	1

FESTA**KLIJEŠTA SJEKAČA****Cr-Mo****HRC 58-62**

Broj	specifikacija	max. Ø drátu	
17051	14' 350 mm	max. 5 mm < 45 HRC	1
17052	18' 450 mm	max. 6 mm < 45 HRC	1
17053	24' 610 mm	max. 8 mm < 45 HRC	1
17054	30' 760 mm	max. 10 mm < 45 HRC	1
17048	36' 900 mm	max. 12 mm < 45 HRC	1

**FESTA****KLIJEŠTA SJEKAČA**

· žice

Cr-Mo**HRC 58-62**

Broj	specifikacija	max. Ø drátu	max. Ø lanka	max. Ø kabelu	
17055	14' 360 mm	max. 5 mm < 45 HRC	max. 3,5 mm	max. 8 mm	1
17056	18' 460 mm	max. 6 mm < 45 HRC	max. 5 mm	max. 10 mm	1
17057	24' 610 mm	max. 8 mm < 45 HRC	max. 7 mm	max. 12 mm	1
17058	30' 760 mm	max. 10 mm < 45 HRC	max. 9 mm	max. 14 mm	1
17046	35' 900 mm	max. 12 mm < 45 HRC	max. 10 mm	max. 16 mm	1

**FESTA****KLIJEŠTA SJEKAČA****Cr-Mo****HRC 57-62****max. Ø
4 mm**

Broj	specifikacija		
17038	8' 210 mm	max. 4 mm < 30 HRC	10

**FESTA****KLIJEŠTA SJEKAČA**

- mekana žica: Ø 6 mm
- srednje tvrda žica: Ø 5 mm
- tvrda žica: Ø 4 mm

CrV

Broj	Specifikacija		
17078	200 mm		12

**KLIJEŠTA SJEKAČA**

Broj	specifikacija	max. Ø drátu	
17028	14' 350 mm	max. 5 mm < 30 HRC	30
17020	18' 450 mm	max. 6 mm < 30 HRC	6
17021	24' 610 mm	max. 8 mm < 30 HRC	10
17022	30' 760 mm	max. 10 mm < 30 HRC	5

NEW



FESTA

KLJIJEŠTA ARMIRAČKA

CrV HRC 58-62

Broj	specifikacija	
17172	200 mm	1



FESTA

KLJIJEŠTA STOLARSKA

CrV

Broj	specifikacija	
17300	160 mm	1
17301	180 mm	10
17302	200 mm	6
17303	250 mm	1



FESTA

KLJIJEŠTA ARMIRAČKA

CrV

Broj	specifikacija	
17305	220 mm	5
17306	250 mm	1
17304	275 mm	6



KLJIJEŠTA STOLARSKA

Broj	specifikacija	
17015	160 mm	6
17016	180 mm	6
17017	200 mm	6



KLJIJEŠTA ARMIRAČKA

Broj	specifikacija	
17019	220 mm	6
17083	275 mm	6



FESTA

KLJIJEŠTA LIMARSKA RAVNA

Broj	specifikacija	
17089	150 x 215 mm	2

NEW



FESTA

KLJIJEŠTA LIMARSKA RAVNA

Broj	specifikacija	
17341	24 x 180 mm	1

NEW



FESTA

KLJIJEŠTA LIMARSKA SAVINUTA 45°

Broj	specifikacija	
17342	24 x 180 mm	1



FESTA

KLJIJEŠTA LIMARSKA RAVNA

Broj	specifikacija	
17093	95 x 270 mm	6



FESTA

KLJIJEŠTA LIMARSKA SAVINUTA 45°

Broj	specifikacija	
17091	50 x 280 mm	10



FESTA

KLJIJEŠTA LIMARSKA SAVINUTA 90°

Broj	specifikacija	
17092	50 x 260 mm	10



FESTA

KLJIJEŠTA LIMARSKA RAVNA

Broj	specifikacija	
17090	50 x 280 mm	10

**FESTA**

ŠKARE ZA LIM

CrV

Broj	specifikacija	
17170	50 250 mm	6



ŠKARE ZA LIM

CrV

Broj	specifikacija	
17167	70 300 mm	5



ŠKARE ZA LIM

CrV

Broj	specifikacija	
17165	60 250 mm	5



ŠKARE ZA LIM

CrV

Broj	specifikacija	
17169	35 250 mm	5

FESTAŠKARE ZA LIM
PRODUŽENE**Cr-Mo** HRC 58-62

Broj	specifikacija	
17113	ravna 80 300 mm	6

**FESTA**

ŠKARE ZA LIM

Cr-Mo HRC 58-62

Broj	specifikacija	
17111	ravna 40 250 mm	6
17116	desna 40 250 mm	6
17121	lijeva 40 250 mm	6

**FESTA**

ŠKARE ZA LIM

Cr-Mo HRC 58-62

Broj	specifikacija	
17112	ravna 40 260 mm	6
17117	desna 40 260 mm	6
17122	lijeva 40 260 mm	6





**NASTAVAK
ZA REZANJE
METALNIH PLOČA**

0.8-1mm	1.5mm	1.5mm	
Broj specifikacija			
20364			1



ŠKARE ZA LIM

max 0,8 mm

Broj specifikacija			
17186			6



STOLNE ŠKARE SA POLUGOM

	17175	17177
	max. 4mm	5mm
	max. \varnothing 10mm	\varnothing 12mm
	max. 8x8mm	10x10mm

Broj specifikacija			
17175	150 mm	1	
17177	250 mm	1	

**NASTAVAK ZA
REZANJE METALNIH PLOČA**

Maksimalna debljina lima

- 1,8 mm - čelik
- 1,2 mm - nehrđajući
- 2 mm - plastika, aluminij, bakar



Broj specifikacija			
20363			5



ŠKARE TEHNIČKE

INOX



Č.p.	specifikacije	
16420	60 200 mm	12

ŠKARE

INOX



Č.p.	specifikacije	
17159	65 220 mm	12



ŠKARE TEHNIČKE

INOX



Č.p.	specifikacije	
17158	50 150 mm	10



ŠKARE

INOX



Č.p.	specifikacije	
17160	70 210 mm	12

ŠKARE

INOX

Č.p.	specifikacije	
16405	14 cm	24
16406	17 cm	24
16407	19 cm	24
16408	21,5 cm	12



ŠKARE

3x INOX

Č.p.	specifikacije	
16401	3 ks	48



FESTA

KLIJEŠTA ZA BUŠENJE RUPA



Broj	specifikacija	
17185	Ø 2; 2,5; 3; 3,5; 4; 4,5 mm	12



FESTA

KLIJEŠTA ZA PVC LAJSNE

· koristiti za: letvice, cijevi, profile



Broj	specifikacija	
17050	60 250 mm ø 17 mm, ø 20 mm, ø 27 mm	8



SPOJNA KLIJEŠTA ZA PROFILE



Broj	specifikacija	
17187	350 mm	6



SPOJNA KLIJEŠTA ZA PROFILE



Broj	specifikacija	
17188	250 mm	12



KLIJEŠTA ZA MHD TIPLE



Broj	specifikacija	
17189	255 mm	12



FESTA

FESTA

KLJIJEŠTA ZA NITANJE

Cr-Mo

- Ø 2,4 mm
- Ø 3,2 mm
- Ø 4,0 mm
- Ø 4,8 mm



Broj 24007
specifikacija 200 mm



1



FESTA

KLJIJEŠTA ZA NITANJE

Cr-Mo

- Ø 2,4 mm
- Ø 3,2 mm
- Ø 4,0 mm
- Ø 4,8 mm



Broj 24010
specifikacija 250 mm



12



FESTA

KLJIJEŠTA ZA NITANJE

Cr-Mo

- Ø 2,4 mm
- Ø 3,2 mm
- Ø 4,0 mm
- Ø 4,8 mm
- Ø 6,4 mm



Broj 24017
specifikacija 280 mm



1



FESTA

KLJIJEŠTA ZA NITANJE

Cr-Mo

- Ø 2,4 mm
- Ø 3,2 mm
- Ø 4,0 mm
- Ø 4,8 mm
- Ø 6,4 mm



Broj 24015
specifikacija 530 mm



1



FESTA

KLJIJEŠTA ZA NITANJE

Cr-Mo

- Ø 2,4 mm
- Ø 3,2 mm
- Ø 4,0 mm
- Ø 4,8 mm



Broj 24030
specifikacija 255 mm



24



FESTA

KLJIJEŠTA ZA NITANJE

Cr-Mo



Broj 24020
specifikacija 290 mm



8





KLJIJEŠTA ZA NITANJE



Broj	specifikacija	
24001	260 mm	6

KLJIJEŠTA ZA NITANJE
KOMPLET

Cr-Mo

- Ø 2,4 x 6 mm
- Ø 3,2 x 6 mm
- Ø 4,0 x 6 mm
- Ø 4,8 x 6 mm



Broj	specifikacija	
24005	260 mm	5



KLJIJEŠTA ZA NITANJE



Broj	specifikacija	
24000	240 mm	24

FESTA

GLAVA ZA BLOK
ZAKOVICE SA ADAPTEROM
ZA BUŠILICU

- Ø 2,4 mm
- Ø 3,2 mm
- Ø 4,0 mm
- Ø 4,8 mm



Cr-Mo



Broj	specifikacija	
24008		1

POP ZAKOVICE

ALU

50x



Broj	specifikacija	
23970	3,2 x 6 mm	25
23971	3,2 x 8 mm	25
23972	3,2 x 10 mm	25
23973	3,2 x 12 mm	25
23974	3,2 x 14 mm	25
23975	4,0 x 6 mm	25
23976	4,0 x 8 mm	25
23977	4,0 x 10 mm	25
23978	4,0 x 12 mm	25
23979	4,0 x 14 mm	25
23985	4,8 x 6 mm	25
23986	4,8 x 8 mm	25
23987	4,8 x 10 mm	25
23988	4,8 x 12 mm	25
23989	4,8 x 14 mm	25



FESTA

KLJIJEŠTA ZA NITANJE
MATICA

Cr-Mo

- M3
- M4
- M5
- M6
- M8
- M10



Broj	specifikacija	
24036	330 mm	1

FESTA

ZAMJENSKE GLAVE

· pogodno za 24035, 24036

Cr-Mo



Broj	specifikacija	
24038	M3	1
24039	M4	1
24040	M5	1
24041	M6	1
24042	M8	1
24043	M10	1



FESTA

KLJIJEŠTA ZA NITANJE
MATICA

Cr-Mo

- M3
- M4
- M5
- M6



Broj	specifikacija	
24035	200 mm	1

MATICE ZA NITANJE,

ALU





20x



Broj	specifikacija	
23950	M3 x 9 mm	20
23951	M4 x 11 mm	20
23952	M5 x 12 mm	50
23953	M6 x 14 mm	50
23954	M8 x 16,5 mm	25
23955	M10 x 18 mm	20

FESTA

KLAMERICA





-  | 6 - 14 mm
23960 - 23964
23760 - 23764,
23906 - 23914
-  | 10 - 14 mm
23965
-  | 15 mm
23966
-  | 15 mm
23967



Broj	specifikacija	
23927		6

FESTA

KLAMERICA



-  | 6 - 14 mm
23960 - 23964
-  | 12 mm
23965
-  | 14 mm
23966
-  | 14 mm
23967



Broj	specifikacija	
23924		12

FESTA

KLAMERICA

-  | 6 - 14 mm
23960 - 23964
-  | 14 mm
23966
-  | 14 mm
23967



Broj	specifikacija	
23923		12



FESTA

KLAMERICA

-  53 | 4 - 14 mm
23904 - 23914,
23760 - 23765

Broj	specifikacija	
23925	4 - 14 mm interlock sustav	20



KLAMERICA

-  53 | 4 - 14 mm
23760 - 23765,
23904 - 23914

Broj	specifikacija	
23800		20



KLAMERICA



-  | 0,7 mm
a=9-11 mm, b=5,5mm, c=6,4mm

Broj	specifikacija	
23920		4



FESTA

ČEKIĆ KLAMERICA

-  | 6 - 10 mm
23960 - 23962

Broj	specifikacija	
23922		10



ČEKIĆ KLAMERICA

-  | 6 - 10 mm
23960 - 23962

Broj	specifikacija	
23928		6



FESTA

UREĐAJ ZA UKLANJANJE MUNICIJE

Broj	specifikacija	
23945		25

FESTA

MUNICIJA ZA KLAM. EXTRA



Broj	specifikacija	
23960	b=6 mm, 1000 kom.	50
23961	b=8 mm, 1000 kom.	50
23962	b=10 mm, 1000 kom.	50
23963	b=12 mm, 1000 kom.	50
23964	b=14 mm, 1000 kom.	50

FESTA

MUNICIJA ZA KLAM.

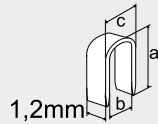

Broj	specifikacija	
23965	a=12 mm, b=6,5 mm, c=7,5 mm, 1000 TW	50

MUNICIJA ZA KLAM. (TYP 53)

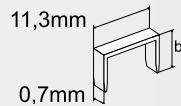

Broj	specifikacija	
23904	b=4 mm 1000 kom.	200
23906	b=6 mm 1000 kom.	200
23908	b=8 mm 1000 kom.	200
23910	b=10 mm 1000 kom.	200
23912	b=12 mm 1000 kom.	200
23914	b=14 mm 1000 kom.	200

**FESTA**

MUNICIJA ZA KLAM.



Broj	specifikacija	
23966	14 mm 1000 TW	100

FESTA

MUNICIJA ZA KLAM.



Broj	specifikacija	
23967	14 mm 1000 TW	100

MUNICIJA ZA KLAM. (TYP 53)

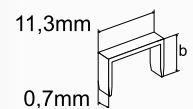
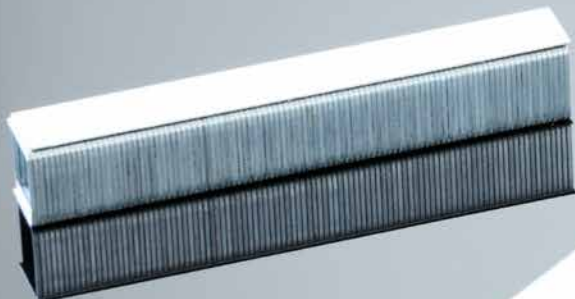
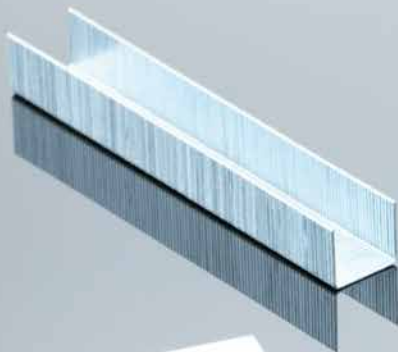

Broj	specifikacija	
23760	b=4 mm 2000 kom.	10
23761	b=6 mm 2000 kom.	10
23762	b=8 mm 2000 kom.	10
23763	b=10 mm 2000 kom.	10
23764	b=12 mm 2000 kom.	10

**FESTA**

FESTA



FESTA

ŽIČANA ČETKA



Broj	specifikacija	linije	
22080	270 mm	5 linije	12

FESTA

ŽIČANA ČETKA



Broj	specifikacija	linije	
22082	270 mm	5 linije	12

FESTA

KOMPLET ŽIČANIH ČETKI



· najlon, inoks, mjed

3x

Broj	specifikacija	
22086	180 mm	12

KOMPLET ŽIČANIH ČETKI

**3x**

Broj	linije	
22081	3 linije	12

22158



22159



ŽIČANA ČETKA

Broj	specifikacija	Žice	
22158	200 mm	čelik	1
22159	200 mm	mjed	1

22035



22036



ŽIČANA ČETKA

Broj	specifikacija	Žice	
22035	270 mm	čelik	24
22036	270 mm	nehrđajući čelik	24



ŽIČANA ČETKA

Broj	specifikacija	linije	
22033	300 mm	4 linije	12
22034	300 mm	5 linije	12



ŽIČANA ČETKA

· mesingano		
Broj	linije	
22078	3 linije	20



ŽIČANA ČETKA

· mesingano			
Broj	specifikacija	linije	
22079	300 mm	4 linije	6

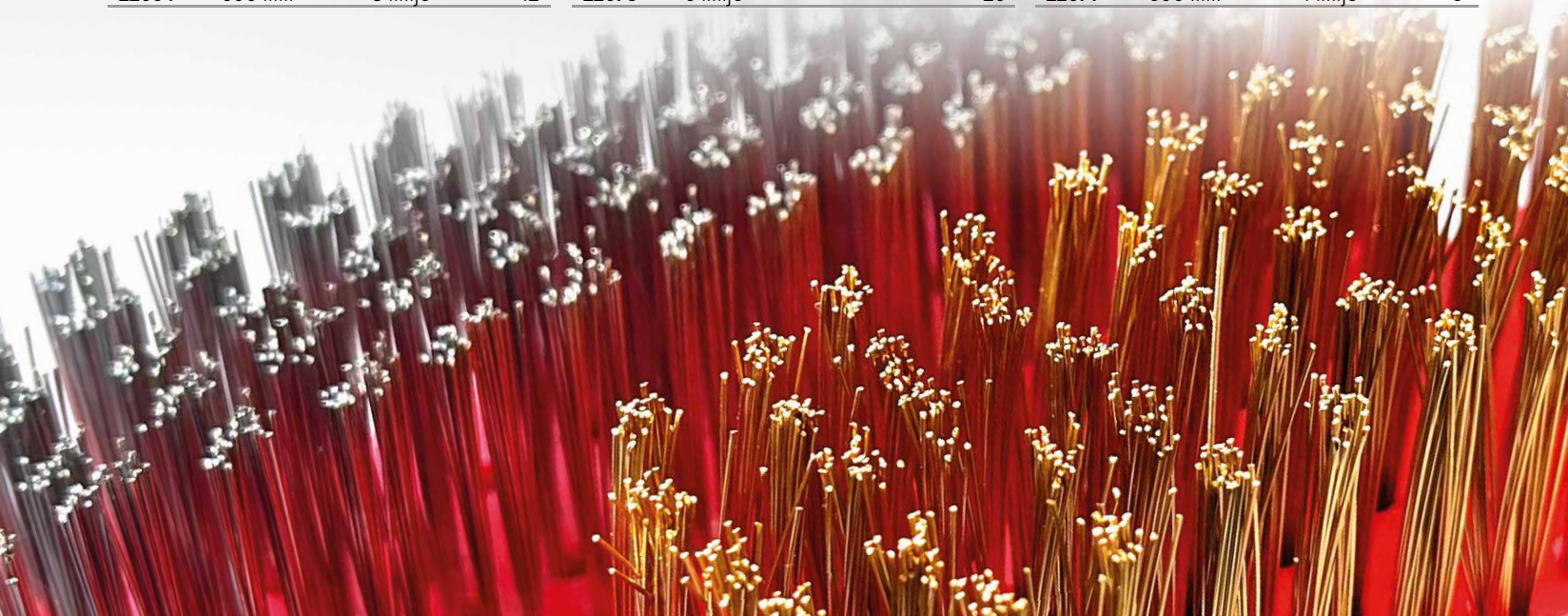

FESTA

FESTA
TROKUTASTA TURPIJA ZA PILE

Broj	specifikacija	oštrina	
22178	150 mm	1	10

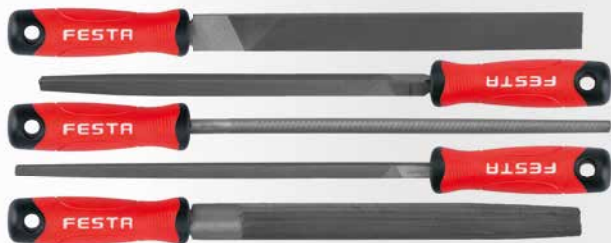
FESTA
KOMPLET TURPIJA

Broj	specifikacija	oštrina	
22209	150 mm	2	10
22186	250 mm	2	5

FESTA
RAVNA TURPIJA

Broj	specifikacija	oštrina	
22206	150 mm	2	10
22180	250 mm	2	10

FESTA
POLUOKRUGLA TURPIJA

Broj	specifikacija	oštrina	
22207	150 mm	2	10
22182	250 mm	2	10

FESTA
ČETVRTASTA TURPIJA

Broj	specifikacija	oštrina	
22184	250 mm	2	10

FESTA
TROKUTASTA TURPIJA

Broj	specifikacija	oštrina	
22183	250 mm	2	10

FESTA
OKRUGLA TURPIJA

Broj	specifikacija	oštrina	
22181	250 mm	2	10

FESTA
KOMPLET TURPIJA

Broj	specifikacija	oštrina	
22208	150 mm	2	10
22185	250 mm	2	5

**FESTA**

TURPIJA ZA MOTORNU PILU



Broj	specifikacija		Broj	specifikacija	
22170	200 mm 3,5 mm	10	22173	200 mm 5 mm	10
22171	200 mm 4 mm	10	22174	200 mm 5,5 mm	10
22172	200 mm 4,5 mm	10			



Ø 4 mm

FESTA

PRIBOR ZA BRUŠENJE LANCA



Broj	specifikacija	
22190	300 mm	5

**FESTA**

KOMPLET IGLIČASTIH TURPIJA



10x	Broj	specifikacija	20
	22188		

**FESTA**

KOMPLET DIJAMANTNIH TURPIJA



10x	Broj	specifikacija	25
	22189		

**FESTA**

TURPIJE



Broj	specifikacija	
22202	150 mm	10
22197	300 mm	10

**FESTA**

KOMPLET VELIKIH TURPIJA



3x	Broj	specifikacija	5
	22196	250 mm	

**FESTA**

TURPIJE



Broj	specifikacija	
22203	150 mm	6
22199	300 mm	6

**FESTA**

TURPIJE



Broj	specifikacija	
22204	150 mm	10
22205	250 mm	10
22198	300 mm	10

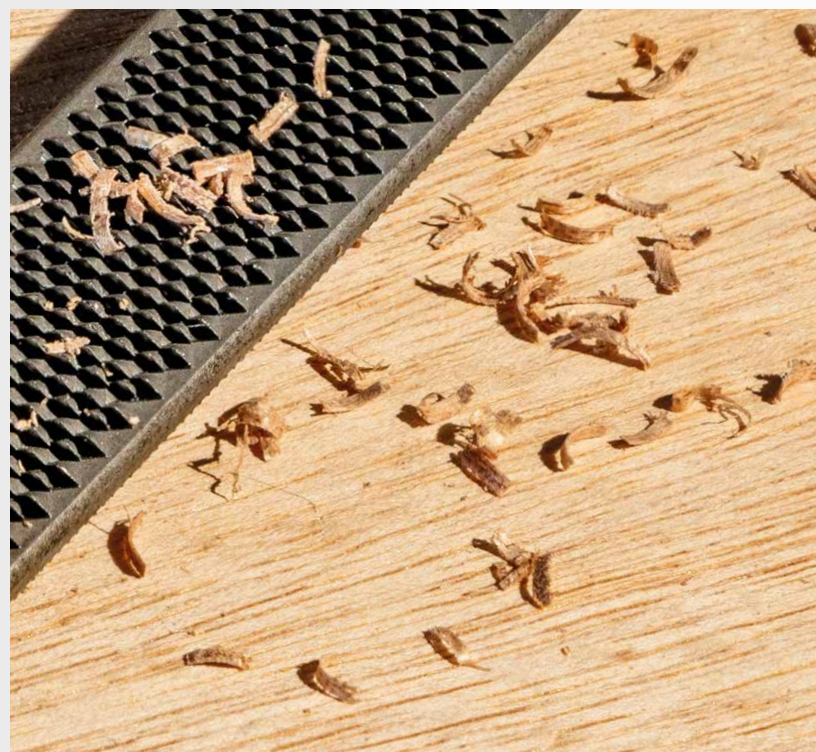

FESTA

PILA ZA METAL



Broj	specifikacija	
24104	300 mm	6

FESTA

PILA ZA METAL

· pojačan okvir



Broj	specifikacija	
24102	300 mm	6

FESTA

PILA ZA METAL



Broj	specifikacija	
24100	300 mm	12

PILA ZA METAL

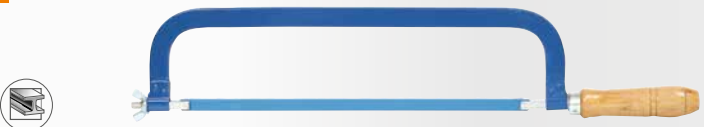

Broj	specifikacija	
24153	300 mm	12

PILA ZA METAL



Broj	specifikacija	
24170	300 mm	12

FESTA

PILA ZA METAL



Broj	specifikacija	
24126	300 x 25 x 0,65 mm TPI 24 14	10

FESTA

PILA ZA METAL

· pila list 24108



Broj	specifikacija	
24125	150 mm	6

FESTA

PILA ZA METAL

· pila list 24109



Broj	specifikacija	
24124	260 mm	12



PILA

Broj	specifikacija	
24121	pila	12
24110	noževi	30

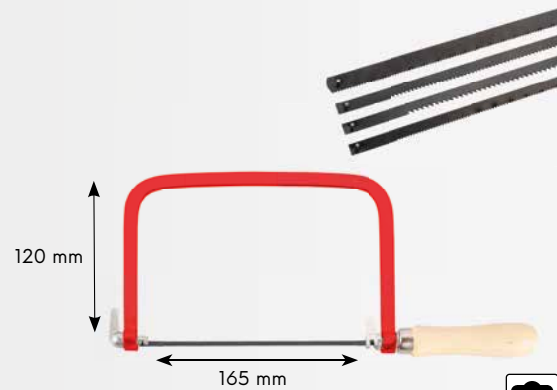

PILA

· 5x noževi

Broj	specifikacija	
24122	pila	20
24111	noževi	30

FESTA

PILA

TEFLON · 3x brušeni i kaljeni zubi

Broj	specifikacija	
24143	300 mm	12
24144	400 mm	12
24145	500 mm	12



FESTA

PILA

TEFLON · 3x brušeni i kaljeni zubi

Broj	specifikacija	
24147	300 mm	6



FESTA

PILA

· 3x brušeni i kaljeni zubi

Broj	specifikacija	
24149	300 mm	12



FESTA

JAPANSKA PILA

SK5 · 3x brušeni i kaljeni zubi

Broj	specifikacija	
24134	250 mm 0,5 mm	10



FESTA

JAPANSKA PILA

SK5 · 3x brušeni i kaljeni zubi

Broj	specifikacija	
24115	260 mm 0,6 mm	10



FESTA

JAPANSKA PILA

SK5 · 3x brušeni i kaljeni zubi

Broj	specifikacija	
24114	260 mm 0,6 mm	10

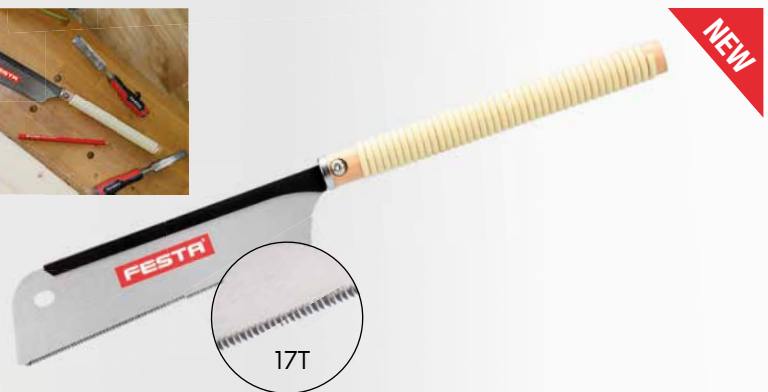



KUTNA PILA



Broj	specifikacija	
24130	600 mm	1
24131	600 mm, noževi	1



KUTNA PILA



Broj	specifikacija	
24148	300 mm	25

DRVENA ŠABLONA



· bukva
MADE IN EU

Broj	specifikacija	
24171	80 x 300 mm	10

ŠABLONA



Broj	specifikacija	
24133	300 x 140 mm	18

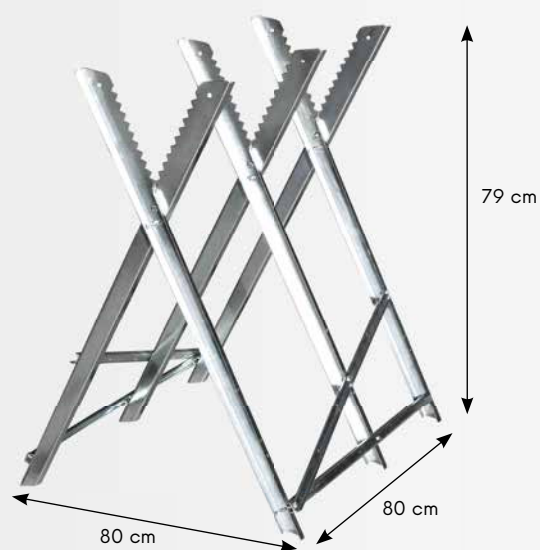

STALAK ZA REZANJE DRVA



Broj	specifikacija	
37570	max. 150 kg	3

FESTA

PILA ZA DRVO

· kaljeni zubi



Broj	specifikacija		Broj	specifikacija	
24141	450 mm	12	24136	760 mm	12
24140	533 mm	12	24142	800 mm	12
24135	610 mm	12	24137	914 mm	12

FESTA

PILA OKRETNNA ZA DRVO

· kaljeni zubi



Broj	specifikacija	
24173	350 mm	24

PROREZAVAJUĆA PILA



Broj	specifikacija	
24151	300 mm	10

PILA VRTNA



Broj	specifikacija	
24150	300 mm	5

PILA ZA KOSTI

Broj	specifikacija	
24128	450 mm noževi 24192	6

**FESTA**

PREKLOPNA PILA



3x brušeni i kaljeni zubi



Broj	specifikacija	
45061	150 mm s poklopcem ručke	12

**FESTA**

PREKLOPNA PILA



3x brušeni i kaljeni zubi



Broj	specifikacija	
45060	180 mm	6

**FESTA**

PILA



3x brušeni i kaljeni zubi



Broj	specifikacija	
45062	260 mm sa futrolom	24



PROREZAVAJUĆA PILA



3x brušeni i kaljeni zubi



Broj	specifikacija	
24152	350 mm 6 tpi	12

**FESTA**

TELESKOPSKA PILA



3x brušeni i kaljeni zubi



Broj	specifikacija	
45033	230 - 490 mm	1

PILA
GUSJENICA

Broj	specifikacija	
45030	pila 30 cm	6
45031	pila 30 cm	6

TELESKOP ŠTAP
ZA PILU

Broj	specifikacija	
45032	Teleskop štap	6

FESTA

PILA ZA POLYSTYREN

Broj	specifikacija	
24174	380 mm	1

**FESTA**

PILA ZA GIPSANE PLOČE



· 3x brušeni i kaljeni zubi

Broj	specifikacija	
24159	150 mm	12

**FESTA**

PILA ZA ŠUPLJU CIGLU



Broj	specifikacija	
24181	550 mm	1



PROREZAVAJUĆA PILA ZA GIPS PLOČE



Broj	specifikacija	
24190	270 mm	10

**FESTA**

PILA ZA YTONG



Broj	specifikacija	
24158	22 22 SK zuba - 450 mm	5

**FESTA**

PILA ZA YTONG



Broj	specifikacija	
24155	34 17 SK zuba - 600 mm	2
24156	34 34 SK zuba - 600 mm	2

**FESTA**

PILA ZA YTONG

· kaljeni zubi



Broj	specifikacija	
24175	bez SK zuba - 600 mm EU	2
24178	bez SK zuba - 600 mm	6

**FESTA**

PILA ZA YTONG

Broj	specifikacija	
24176	34 17 SK zuba - 750 mm	6
24177	34 34 SK zuba - 750 mm	6



**FESTA**

ČEKIĆ

· drška od jasena

DIN
1041

Broj	specifikacija	
19081	100 g	1
19082	200 g	1
19083	300 g	1
19084	400 g	1
19085	500 g	1
19086	600 g	1
19088	800 g	1
19090	1000 g	1
19092	1500 g	1
19095	2000 g	1

**FESTA**

BAT

· drška od jasena

DIN
1041

Broj	specifikacija	
19096	3000 g	1
19097	4000 g	1
19098	5000 g	1
19106	6000 g	1
19108	8000 g	1
19109	10000 g	1

**FESTA**

BAT

· drška od jasena

DIN
6475

Broj	specifikacija	
19041	1000 g	1
19042	1250 g	1
19043	1500 g	1
19044	2000 g	1

**FESTA**

BAT

· drška od jasena

DIN
6475

Broj	specifikacija	
19045	3000 g	1
19046	4000 g	1
19074	5000 g	1
19075	6000 g	1
19076	8000 g	1
19077	10000 g	1

**FESTA**

ČEKIĆ FIBERGLASS

· drška fiberglass

Č.p.	specifikace	
19021	100 g	12
19022	200 g	12
19023	300 g	12
19024	400 g	12
19025	500 g	12
19026	600 g	6
19028	800 g	6
19030	1000 g	6
19031	1500 g	6
19032	2000 g	1

**FESTA**

BAT FIBERGLASS

· drška fiberglass

DIN
6475

Č.p.	specifikace	
19066	1000 g	4
19067	1250 g	4
19068	1500 g	4
19069	2000 g	2

FESTA

BAT FIBERGLASS

· drška fiberglass



Č.p.	specifikace	
19034	3000 g	4
19036	4000 g	4

· drška fiberglass

DIN
6475

Č.p.	specifikace	
19070	3000 g	4
19071	4000 g	4
19058	5000 g	4
19059	6000 g	2

FESTA**ČEKIĆ
TESARSKI
FIBERGLAS**

· drška fiberglass



Č.p.	specifikace	
19061	600 g	6

**FESTA****ČEKIĆ
FIBERGLAS**

· drška fiberglass

Č.p.	specifikace	
19064	450 g	6

**FESTA****ČEKIĆ
TESARSKI
MONOLIT**

Č.p.	specifikace	
19062	600 g	6

**FESTA****ČEKIĆ
MONOLIT**

Č.p.	specifikace	
19063	450 g	6

**ČEKIĆ
TESARSKI**

Č.p.	specifikace	
19100	600 g	6

**FESTA****ČEKIĆ
ZIDARSKI
MONOLIT**

Č.p.	specifikace	
19150	600 g	6

**FESTA****ČEKIĆ TESARSKI**

Č.p.	specifikace	
19060	600 g	6

**FESTA****ČEKIĆ KESER**

Č.p.	specifikace	
19065	450 g	6

**FESTA****ČEKIĆ
ZIDARSKI
FIBERGLAS**

· drška fiberglass

Č.p.	specifikace	
19151	600 g	6

**FESTA****ČEKIĆ ZIDARSKI**

· drška od jasena

Č.p.	specifikace	
19149	44 mm	1

**FESTA****ČEKIĆ ZIDARSKI**

· drška od jasena

Č.p.	specifikace	
19124	24 mm	1
19136	36 mm	1
19148	48 mm	1

**FESTA****ČEKIĆ - SJEKIRA**

Č.p.	specifikace	
19303	600 g	6



FESTA**BAT**

Č.p.	specifikace	
19051	1000 g	6
19052	1500 g	6

**BAT**

· kružni klin

DIN 6475

Č.p.	specifikace	
19053	1000 g	6
19050	1250 g	6
19054	1500 g	6
19055	2000 g	6

ČEKIĆ

· kružni klin

DIN 1041

Č.p.	specifikace	
19001	100 g	12
19002	200 g	12
19003	300 g	6
19004	400 g	6
19005	500 g	6
19006	600 g	6
19008	800 g	6
19010	1000 g	6
19015	1500 g	6
19020	2000 g	6

BAT

· kružni klin

DIN 6475

Č.p.	specifikace	
19056	3000 g	6
19057	4000 g	6

ČEKIĆ VARILAČKI

Č.p.	specifikace	
19115	320 g	1

**FESTA****DRŠKA ZA ČEKIĆ JASEN**

Broj	specifikacija	
61240	drška	1

**DRŠKA ZA ČEKIĆ JASEN**

Broj	specifikacija	za čekić	
61320	26 cm	19081	10
61321	28 cm	19082	10
61322	30 cm	19083	10
61323	31 cm	19084	10
61324	32 cm	19085	10

**DRŠKA ZA BAT JASEN**

Broj	specifikacija	za čekić	
61330	80 cm	19074, 19075	10
61331	90 cm	19076, 19077	10

**KONUSNO-KLINASTA OKRUGLA KAJLA**

Broj	specifikacija	
19430	6 mm	10
19431	8 mm	10
19432	10 mm	10
19433	12 mm	10
19434	14 mm	10
19435	16 mm	10

**KAJLA**

Broj	specifikacija	
19440	uski	10
19441	srednji	10
19442	široki	10
19443	široki S	10

**FESTA****KAJLA ČELIČNA**

Broj	specifikacija	
19398	20 x 25 x 5 mm	1
19399	30 x 40 x 5 mm	1

**3x**



FESTA



FESTA

BAT DRVENI

· drvo bukva



Broj	specifikacija	
19202	Ø 60 x 120 mm	260 g



FESTA

BAT GUMENI

· drška od jasena



Broj	specifikacija	
19245	Ø 55 mm 400 g	1
19246	Ø 60 mm 800 g	1
19247	Ø 70 mm 1000 g	1
19248	Ø 95 mm 2000 g	1
19249	Ø 115 mm 3000 g	1

FESTA**BAT GUMENI**

· drška fiberglass



Broj	specifikacija	
19270	Ø 55 mm	6
19271	Ø 65 mm	6
19272	Ø 90 mm	6

**FESTA****BAT GUMENI**

Broj	specifikacija	
19255	Ø 55 mm	6
19265	Ø 65 mm	6
19290	Ø 90 mm	6

**FESTA****BAT GUMENI BIJELI**

· drška fiberglass

Broj	specifikacija	
19281	680g	6

**FESTA****BAT GUMENI BIJELI**

Broj	specifikacija	
19293	Ø 55 mm	6
19294	Ø 65 mm	6
19295	Ø 90 mm	6

**FESTA****ČEKIĆ
MESING**

· drška fiberglass

Broj	specifikacija	
19211	Ø 30 mm 500 g	1

**FESTA****BAT NYLON**

· drška fiberglass



Broj	specifikacija	
19209	Ø 34 mm	6

**BAT GUMENI**

Broj	specifikacija	
19251	Ø 55 mm 400 g	12
19252	Ø 65 mm 700 g	6
19253	Ø 90 mm 1300 g	4

**BAT GUMENI
CRNO BIJELI**

Broj	specifikacija	
19254	Ø 65 mm	6

**ČEKIĆ
SILIKONSKI**

Broj	specifikacija	
19297	Ø 30 mm	12

**FESTA****ČEKIĆ SA IZMJENJIVIM KRAJEVIMA**

- PP - 97 Shore A ·
- TPU - 95 Shore A ·
- TPE - 90 Shore A ·
- TPE - 90 Shore A ·
- TPU - 92 Shore A ·
- TPU - 92 Shore A ·
- TPU - 88 Shore A ·
- TPE - 90 Shore A ·

Broj	specifikacija	
19208	Ø 38 mm	1

AUTOLIMARSKI
KOMPLET

7x

Broj 19110
specifikacija



5



FESTA

PAJSER



Broj	specifikacija	Box
19420	300 mm	1



FESTA

PAJSER

Broj	specifikacija	Box
19424	400 mm	6
19425	600 mm	6
19426	800 mm	6
19427	1000 mm	6



PAJSER

Broj	specifikacija	Box
19416	600 mm Ø 16 mm	4
19422	800 mm Ø 16 mm	4
19421	1000 mm Ø 18 mm	4



PAJSER

Broj	specifikacija	Box
19423	380 x 35 x 6 mm	1



PAJSER

Broj	specifikacija	Box
19415	300 mm Ø 15 mm	6



FESTA

**FESTA**

SJEKAČ ZA BETON

CrV	Broj	specifikacija	šifina hrotu	
	19406	300 mm	25 mm	5
	19407	400 mm	30 mm	5

**FESTA**

ŠPICA ZA BETON

CrV	Broj	specifikacija	
	19408	250 mm	5
	19409	350 mm	5

**FESTA**

SJEKAČ ZA BETON

CrV	Broj	specifikacija	šifina hrotu	
	19460	300 mm	25 mm	5
	19470	400 mm	30 mm	5



ŠPICA ZA BETON

Broj	specifikacija	
19400	250 mm	5
19403	350 mm	6



SJEKAČ ZA BETON

Broj	specifikacija	šifina hrotu	
19401	250 mm	19 mm	6
19404	350 mm	22 mm	6



SJEKAČ ZA BETON

Broj	specifikacija	šifina hrotu	
19402	250 mm	50 mm	2
19405	350 mm	50 mm	6

**FESTA**

KOMPLET SJEKAČA I PROBIJAČA

12x CrV

- 2, 6, 8 mm
- 10, 12, 16 mm
- Ø 1,5-3-4-5-6-8 mm

Broj	specifikacija	
19487		4

**FESTA**

KOMPLET SJEKAČA I PROBIJAČA

6x CrV

- 2 x 140, 8 x 115 mm
- 12 x 152, 10 x 142 mm
- Ø 3 x 152, 6 x 152 mm

Broj	specifikacija	
19486		10

**FESTA**

KOMPLET SJEKAČA

3x CrV

- 10, 12, 16 mm

Broj	specifikacija	
19485		10

**FESTA**

TOČKASTO DLIJETO

CrV

Broj	specifikacija	
19429	200 mm	1

**FESTA**

SJEKAČ ZA BETON

CrV

Broj	specifikacija	šifina hrotu	
19410	200 mm	20 mm	10
19411	250 mm	25 mm	10
19412	300 mm	25 mm	10
19418	400 mm	25 mm	5
19419	500 mm	25 mm	5



SJEKAČ ZA BETON

CrV

Broj	specifikacija	šifina hrotu	
19436	200 mm	20 mm	15

FESTA
PROBIJAČI

CrV 3x

Broj	specifikacija	
19480	Ø 0,8, 1,5, 2,5 mm	10



FESTA
TOČKASTI PROBIJAČI

CrV 3x

Broj	specifikacija	
19481	Ø 0,8, 1,5, 2,5 mm	10



FESTA
PROBIJAČI

CrV 6x

Broj	specifikacija	
19483	Ø 3, 4, 5, 6, 7, 8 mm	5



FESTA
TOČKASTI PROBIJAČI

CrV

Broj	specifikacija	
19477	Ø 2,5 mm	20



FESTA
TOČKASTI PROBIJAČ AUTOMATSKI

CrV

Broj	specifikacija	
19478	Ø 2,5 mm	12



FESTA
PROBIJAČI

CrV

Broj	specifikacija	
19472	Ø 4 mm 150 mm	1
19473	Ø 5 mm 150 mm	1
19474	Ø 6 mm 150 mm	1



REZAČ STAKLA



Broj	specifikacija	
20350	130 mm	12



IZREZIVAČI RUPA

Broj	specifikacija	
13x 24695	Ø 5, 6, 8, 10, 11, 13, 16, 19, 22, 25, 28, 32, 35 mm	5



IZREZIVAČI RUPA, KOMPLET

- 24690 - Ø 2,5 mm
- Ø 3 mm
- Ø 4 mm
- Ø 5 mm
- Ø 6 mm
- Ø 7 mm
- Ø 8 mm
- Ø 9 mm
- Ø 10 mm

- 24691 - Ø 2mm
- Ø 2,5 mm
- Ø 3,2 mm
- Ø 4 mm
- Ø 4,8 mm
- Ø 5 mm
- Ø 6,4 mm
- Ø 8 mm
- Ø 9,5 mm
- Ø 11,1 mm
- Ø 12,7 mm
- Ø 14 mm
- Ø 15,8 mm
- Ø 19 mm
- Ø 22 mm



Broj	specifikacija	
24690	9 kom Ø 2,5 - 10 mm	10
24691	15 kom Ø 2 - 22 mm	5

UREZNICE BROJEVI

Broj	specifikacija	
20972	6 mm	5
20973	8 mm	5



UREZNICE ABCEDA

Broj	specifikacija	
20970	6 mm	5
20971	8 mm	5



FESTA
 INDUSTRY

**BRZE
 STEZALJKE**

Broj	specifikacija	
23625	150 mm	6
23626	300 mm	6
23628	450 mm	6
23630	600 mm	6
23632	760 mm	6

NEW
FESTA
 INDUSTRY

**PRODUŽNA
 SPOJNICA
 ZA STEZALJKE**

FESTA INDUSTRY 23625, 23626, 23628, 23630

2x

Broj	specifikacija	
23635		6

FESTA
**BRZOSTEZNA
 STEZALJKA**

Broj	specifikacija	
23570	100 x 80 mm	1
23571	160 x 80 mm	1
23572	200 x 80 mm	1
23573	250 x 80 mm	1
23574	300 x 80 mm	1

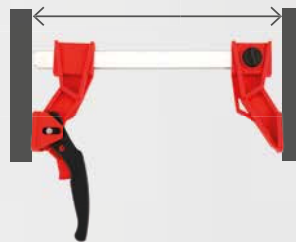
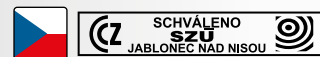
FESTA
STEZALJKE

Broj	specifikacija	
23670	150 x 105 mm	1
23671	200 x 105 mm	1
23672	250 x 105 mm	1
23673	300 x 105 mm	1
23674	350 x 105 mm	1
23675	400 x 175 mm	1
23676	500 x 175 mm	1
23677	600 x 175 mm	1
23678	700 x 175 mm	1
23679	800 x 175 mm	1
23680	1000 x 175 mm	1
23681	1250 x 175 mm	1
23682	1500 x 175 mm	1
23683	1750 x 175 mm	1
23684	2000 x 175 mm	1
23685	2200 x 175 mm	1

FESTA
**BRZE
 STEZALJKE**

Broj	specifikacija	
23585	150 mm	6
23587	300 mm	6
23589	450 mm	6
23591	600 mm	6



FESTA

BRZE STEZALJKE

• kovano



Broj	specifikacija	
23560	200 x 80 mm	1
23561	300 x 100 mm	1
23562	400 x 100 mm	1
23563	500 x 120 mm	1
23564	600 x 120 mm	1
23565	800 x 120 mm	1
23566	1000 x 120 mm	1



STEZALJKE

DIN 5117

Broj	specifikacija	
23506	300 x 120 mm	10
23507	500 x 120 mm	10
23508	800 x 120 mm	6



STEZALJKE

Broj	specifikacija	
23515	150 x 50 mm	50
23520	200 x 50 mm	50
23525	250 x 50 mm	50
23530	300 x 50 mm	50
23531	300 x 120 mm	20
23551	500 x 120 mm	10



NEW



FESTA

MOBILNA BRZA STEZALJKA

Broj	specifikacija	
23595	250/ Ø 20 mm 60 kg	1



NEW



FESTA

MOBILNA BRZA STEZALJKA

Broj	specifikacija	
23598	120/ Ø 20 mm 70 kg	1

NEW



FESTA

STOLARSKA STEZALJKA ZA OKVIRE

Broj	specifikacija	
23637	4m x 25mm	1

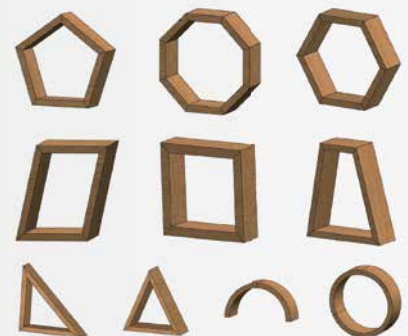

**FESTA****90° ŠKRIPAC****4x**

Broj	specifikacija
23607	silna stezanja - 250 N

ALU**KUTNI ŠKRIPAC 90°**

· zasieg 0 - 65 mm | opseg 0 - 65 mm

Broj	specifikacija
23420	65 mm

**STEZALJKE**

· raspon 80 mm

Broj	specifikacija	
23605	9' 230 mm	6

**STEZALJKA PLASTIČNA**

Broj	specifikacija	
23600	4', raspon 40 mm	20
23601	6', raspon 70 mm	12
23602	9', raspon 100 mm	20

**'G' STEZALJKE KOMPLET****3x**

Broj	specifikacija	
23620	25 mm, 50 mm, 75 mm	10

FESTA



208

RADNI STOL



212

ŠKRIPCI



213

HIDRAULIČNE DIZALICE



218

SVJETILJKE



220

ZATEZAČ UNIVERZALNI



224

LJEPLJIVE TRAKE



227

KARABINI, KUKE, LANCI I
ŽICANA UZAD

230

ZAŠTITNA OPREMA



234

POJASEVI ZA ALAT,
FUTROLE

237

LOKOTI



239

POŠTANSKI SANDUČIĆI I
BLAGAJNE

RADIONICA

208 - 243



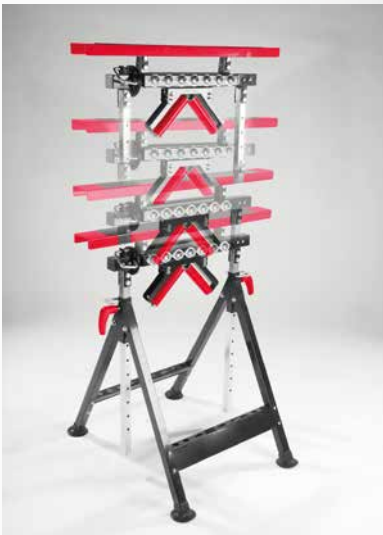

max 200 kg



max 45 kg



max 100 kg



max 100 kg



FESTA

PODESIVI GRAĐEVINSKI POTPORANJ

· max. opterećenje: 200 kg

Broj 36410 specifikacija



1

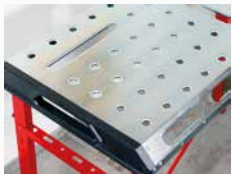

FESTA

SKLOPIVI STOL ZA ZAVARIVANJE

· max. opterećenje: 450 kg

Broj 23652 specifikacija



1



FESTA

PODESIVI GRAĐEVINSKI POTPORANJ

· max. opterećenje: 590 kg

Broj 23657 specifikacija



1



NEW



2x



4x

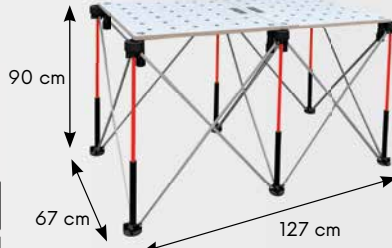
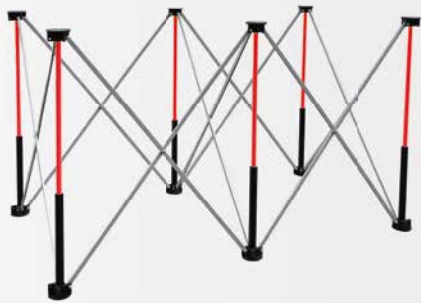

FESTA

PRIENOSNI RADNI STOL, KOMPATIBILNO SA 23664

- 1270 x 670 x 900 mm
- max. opterećenje: 1100 kg



1

Broj specifikacija
23661

NEW



FESTA

RADNA PLOČA, KOMPATIBILNO SA 23661

- 1200 x 600 x 18 mm



1

Broj specifikacija
23664



FESTA

PODESIVI GRAĐEVINSKI POTPORANJ

- max. opterećenje: 230 kg



1

Broj specifikacija
23658

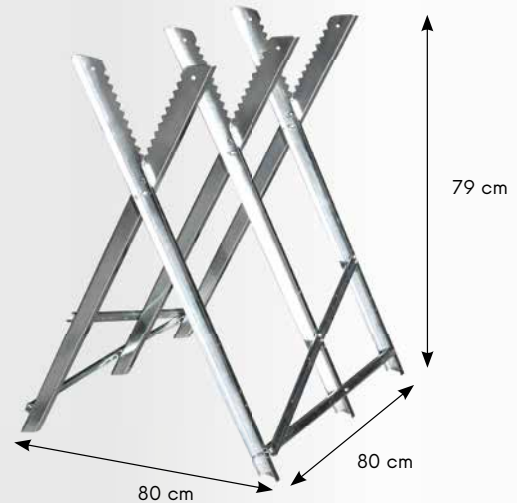

KOZA ZA DRVA

- max. opterećenje: 150 kg



1

Broj specifikacija
37570

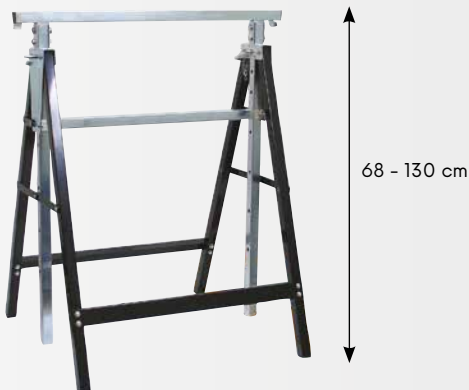

GRAĐEVINSKI POTPORANJ

- max. opterećenje: 125 kg



1

Broj specifikacija
36300



PODESIVI GRAĐEVINSKI POTPORANJ - PLASTIKA

- max. opterećenje 150 kg (300 kg u paru)

2x

Broj specifikacija
37560

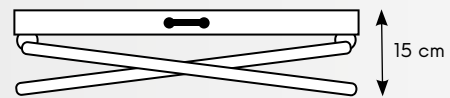
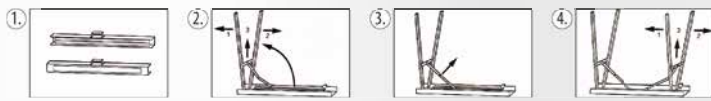
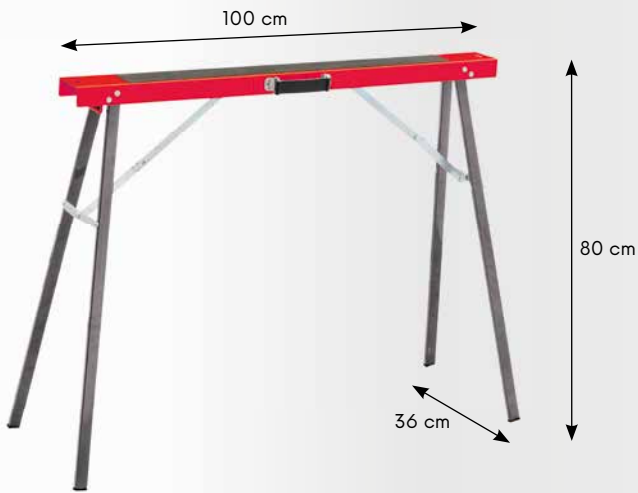

PODESIVI GRAĐEVINSKI POTPORANJ

· max. opterećenje 125 kg

2x			
Broj	specifikacija		
37549	pár	1	

RADNI STOL

· max. 100 kg

Broj	Specifikacija	
23655	100 x 50 x 84 cm	1



RADNI STOL

· idealno za radionice

Broj	specifikacija	
23660		1



RADNI STOL

· max. opterećenje: 100 kg

Broj	specifikacija	
23650		1



AUTOMEHANIČARSKA POMOĆNA SJEDALJKA

· pomična sjedalica sa plastičnom košarom za alat

No.	Specification	
26988	360 x 365 x 365 mm	1

FESTA

MAGNETNI DRŽAČ ALATA



Broj	specifikacija	
70098		12



FESTA

ORMAR ZA ALAT NA KOTAČIMA

No.	Drawers slides	Drawers	Overall dimensions (mm)	
26986	smooth	7	680 x 460 x 1020 mm	1



ORMAR ZA ALAT

· gornji dio se može staviti na ormar sa kotačima

No.	specification	Otvaranje pretinaca	ladice	Unutarnje dimenzije ladice ŠxDxV (mm)	Ukupna dimenzije (mm)	Ukupna težina (kg)	
26985	gornji dio	Lagano	3	151,5 x 225 x 40 mm	600 x 260 x 340 mm	11,5 kg	1
			2	511 x 225 x 40 mm			
	donji dio	Lagano	1	511 x 225 x 85 mm	616 x 330 x 742 mm	16,4 kg kg	
			2	511 x 308 x 85 mm			

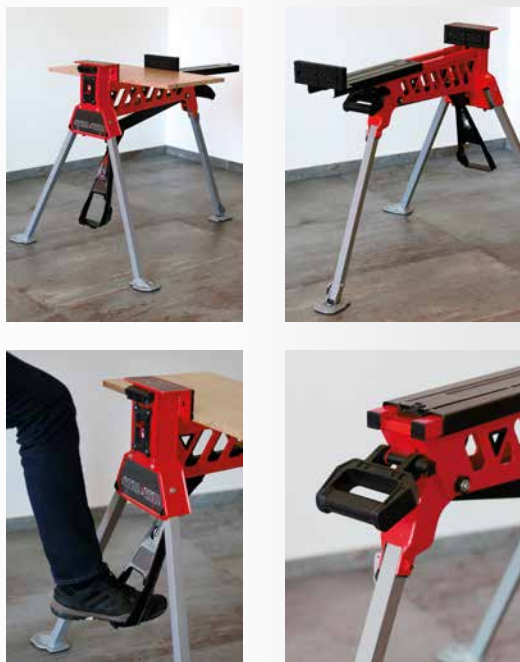
**FESTA****PRIJENOSNI STALAK ŠKRIPAC**

- raspon stezanja: 0 - 95 cm
- max. opterećenje: 250 kg



1

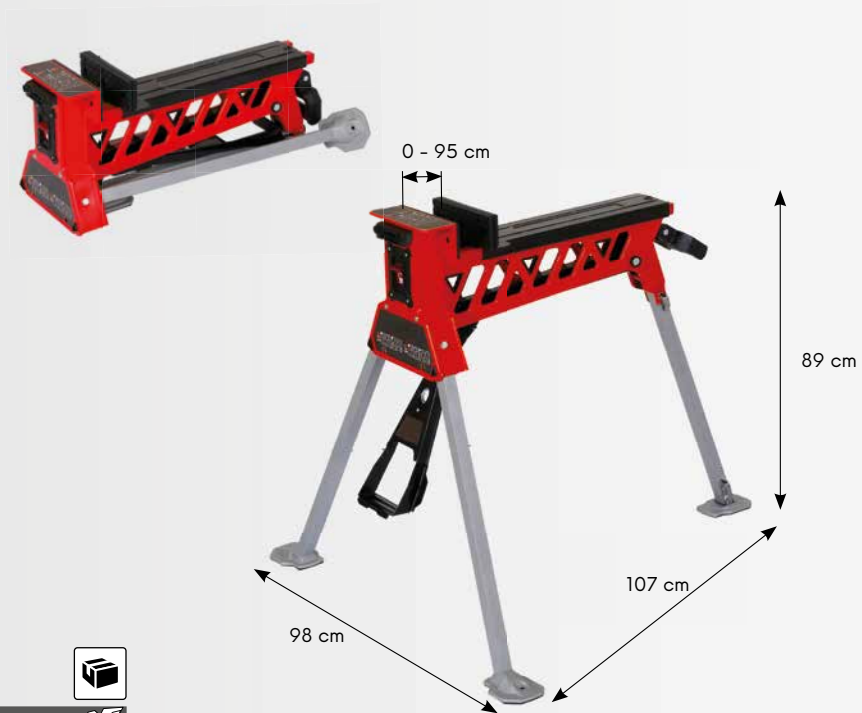

Broj	Specifikacija
37553	

**FESTA****ŠKRIPAC**

- ojačana čeljust

Broj	specifikacija		
23410	100 mm	1	
23411	125 mm	1	
23412	150 mm	1	

**ŠKRIPAC OKRETNI**

- ojačana čeljust

Broj	specifikacija		
23415	100 mm	1	
23416	125 mm	1	
23417	150 mm	1	

**ŠKRIPAC OKRETNI MINI**

Broj	specifikacija	
23407	65 mm	10

**ŠKRIPAC POD STOLNU BUŠILICU**

- ojačana čeljust

Broj	specifikacija		
23400	18 80 mm	10	
23401	22 100 mm	10	
23402	24 125 mm	5	

ŠKRIPAC 360°

ALU	Broj	specifikacija	
	23406	80 mm	24

HIDRAULIČNA DIZALICA, JEDAN KLIP

- prilagodljivost niskom pristupu i maksimalnom podizanje
- dvostruki sigurnosni ventil
- nazubljeni dosjed za siguran prihvat i podizanje
- široko postolje za stabilnost i snagu
- sve opteretive točke su dodatno pojačane radi veće i zdržljivosti



No.	capacity	min. height	Lift	Adjust height	Base dimensions	weight	
26800	2 000 kg	181mm	116 mm	48 mm	88 x 92 mm	2,6 kg	1
26801	3 000 kg	194 mm	118 mm	60 mm	92 x 100 mm	3,3 kg	1
26802	5 000 kg	216 mm	127 mm	70 mm	96 x 112 mm	4,5 kg	1
26803	8 000 kg	230 mm	147 mm	80 mm	103 x 118 mm	5,7 kg	1
26804	10 000 kg	230 mm	150 mm	80 mm	110 x 123 mm	6,8 kg	1
26805	12 000 kg	230 mm	155 mm	80 mm	116 x 134 mm	7,3 kg	1
26806	15 000 kg	230 mm	150 mm	80 mm	133 x 136 mm	8,4 kg	1
26807	20 000 kg	242 mm	150 mm	60 mm	144 x 152 mm	11 kg	1



HIDRAULIČNA DIZALICA, DVA KLIPA

- prilagodljivost niskom pristupu i maksimalnom podizanje
- dvostruki sigurnosni ventil
- nazubljeni dosjed za siguran prihvat i podizanje
- široko postolje za stabilnost i snagu
- sve opteretive točke su dodatno pojačane radi veće i zdržljivosti.



No.	capacity	min. height	Lift	Adjust height	weight	
26815	2 000 kg	150 mm	160 mm	60 mm	4,7 kg	1
26816	4 000 kg	160 mm	170 mm	60 mm	6,4 kg	1
26817	6 000 kg	215 mm	270 mm	-	8,9 kg	1
26819	10 000 kg	228 mm	284 mm	89 mm	10,2 kg	1



DIZALICA



No.	capacity	min. height	max. height	weight	
26844	1 000 kg	88 mm	380 mm	2,5 kg	1
26845	2 000 kg	120 mm	395 mm	3,5 kg	1



HIDRAULIČNA DIZALICA



No.	specification	capacity	min. height	max. height	weight	
26820	hidraulična dizalica 2t, prijenosna	2 000 kg	130 mm	345 mm	9,6 kg	1
26822	hidraulična dizalica 3t, prijenosna	3 000 kg	130 mm	465 mm	27,4 kg	1
26826	hidraulična dizalica za garažu, niski profil, ručka rotirajuća za 360°	2 000 kg	89 mm	359 mm	14,2 kg	1
26824	hidraulična dizalica za garažu, nožna ručka	3 000 kg	145 mm	500 mm	37,2 kg	1
26825	hidraulična dizalica za garažu, niskog profila, profi	2 500 kg	85 mm	455 mm	34,8 kg	1

HIDRAULIČNA DIZALICA + POTPORNJI

· 360° okretna ručka



No.	capacity	min. height	max. height	weight	
26829	2 000 kg	130 mm	350 mm	10,5 kg	1
	2 000 kg	275 mm	420 mm	5 kg (pair)	

PODIZAČ

- 1 par
- dizajnirano sa fini prihvat sa dvostrukom zaštitom
- čvrsta čelična ručka
- širok dosjed, čvrst okvir
- lijavano čelično postolje



No.	specification	capacity	min. height	max. height	weight	
26857	sa iglom za zaključavanje	2 000 kg	275 mm	420 mm	4,8 kg	1
26858	sa iglom za zaključavanje	3 000 kg	285 mm	425 mm	6,3 kg	1
26859	sa iglom za zaključavanje	6 000 kg	393 mm	593 mm	13 kg	1
26853		12 000 kg	465 mm	715 mm	28 kg	1

HIDRAULIČNA DIZALICA, SKLOPIVA

- za podizanje i popravak dijelova kod montaže i demontaže
- regulacija istezanja kрана
- lako sklopiv kran radi skladištenja

No.	capacity	min. height	max. height	weight	
26862	2 000 kg	0	2360 mm	88 kg	1



NOSAČ MOTORA

- izmjenjiva suspenzija, ovisno o nagibu, osigurava sigurno balansiranje i stabilnost pri popravku motora

No.	capacity	length	range	weight	
26871	500 kg	1500 mm	150 mm	20,3 kg	1



HIDRAULIČNA DIZALICA

- lagana montaža i demontaža (motori, prijenosnici i sl.)

No.	specification	capacity	length	range	weight	
26880	hidraulična dizalica	500 kg	1100 mm	1900 mm	30,0 kg	1



26880

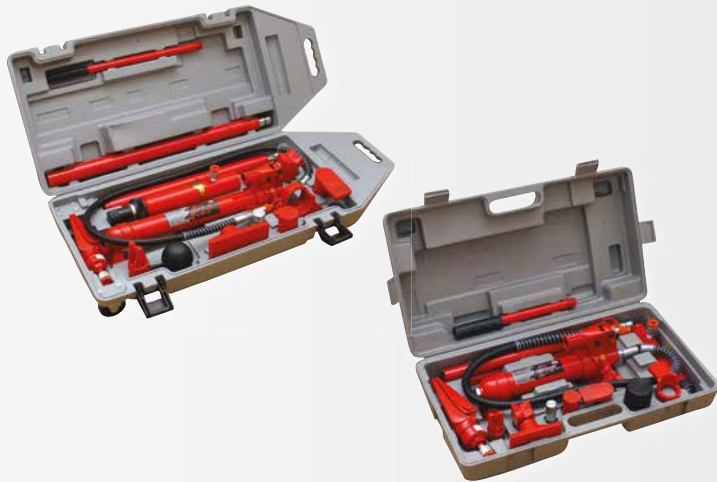

■ PRIJENOSNA HIDRAULIČNA OPREMA

- hidraulička oprema za popravak karoserija vozila
- ima klipni cilindar i dodatke od 14 komada
- široko je primjenjiv za popravak karoserija automobila i kamiona, posebno za rad na terenu bez napajanja
- tijekom upotrebe pribor se može gurati, vući, podizati i izvlačiti u okomitom i vodoravnom smjeru
- jednostavan transport u kutiji



No.	capacity	Hydraulic lift	weight	
26886	4 000 kg	125 mm	17,0 kg	1
26888	10 000 kg	135 mm	32,0 kg	1



■ DRŽAČ MOTORA

- pomični stalak za montažu i demontažu motora
- univerzalni zatežuć za brzo zatezanje i rotaciju motora



No.	capacity	weight	
26920	450 kg	20 kg	1



■ HIDRAULIČNI SAVIJAJČ CIJEVI

No.	Capacity	lift	Bending shoes	Weight	
26895	12 000 kg	232 mm	1 2", 3 4", 1", 1-1 4", 1-1 2", 2"	36 kg	1
26896	16 000 kg	238 mm	1 2", 3 4", 1", 1-1 4", 1-1 2", 2", 2-1 2", 3"	65 kg	1



26897



26943

■ ALAT ZA IZMJENU OPRUGA

- 26897 - za zamjenu macpherson opruga izravno u automobilu
- 26943 - za zamjenu mcperson opruga izvan vozila robusni čelični profili za veću stabilnost



No.	Capacity	Compressed Spring	Compression Length	Weight	
26897	1 000 kg	100-200 mm	150 mm	24,5 kg	1
26943	1 000 kg	400 mm	210-570 mm	35 kg	1



■ SPREMNIK ZA ISTROŠENO MOTORNO ULJE

- izvlačenje ulja iz motora u spremnik kroz posudu
- dodatna oprema za izvlačenje ulja
- ventil za ispušt iz prijemnika



No.	Cubage	Max. Pressure	Weight	
26954	90 l	0,5 MPa	28 kg	1



■ HIDRAULIČNA PREŠA

No.	Range	Max. Capacity	Weight	
26940	0 - 610 mm	12 000 kg	43 kg	1
26941	0 - 880 mm	20 000 kg	75 kg	1

HIDRAULIČNA PUMPA DUGI KLIP



No.	specification	Capacity	Min. Length	Max. Length	Weight	
26911	jedna pumpa	5 000 kg	620	1100	12 kg	2
26912	jedna pumpa	8 000 kg	620	1100	13 kg	2
26914	dvije pumpe	5 000 kg	620	1100	12 kg	2
26915	dvije pumpe	8 000 kg	620	1100	14 kg	2

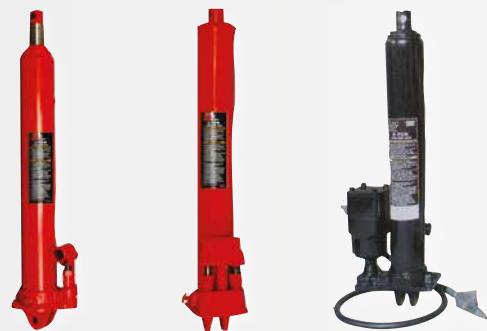

REZERVNI DIJELOVI ZA ORMAR ZA PJEŠKARENJE

No.	rozměry	
26973	rukavice	1
26974	mlaznice	1
26975	folija 53,5 x 26 cm	1
26976	pleksiglas 60 x 30 cm	1
26977	staklo 60 x 30 cm	1

ORMAR ZA PJEŠKARENJE

No.	Air consumption	Outside dimensions	Inside dimensions	Max. Pressure	Weight	
26972	420-710 l/min.	1500 x 830 x 630 mm	600 x 840 x 630 mm	8 bar	38 kg	1

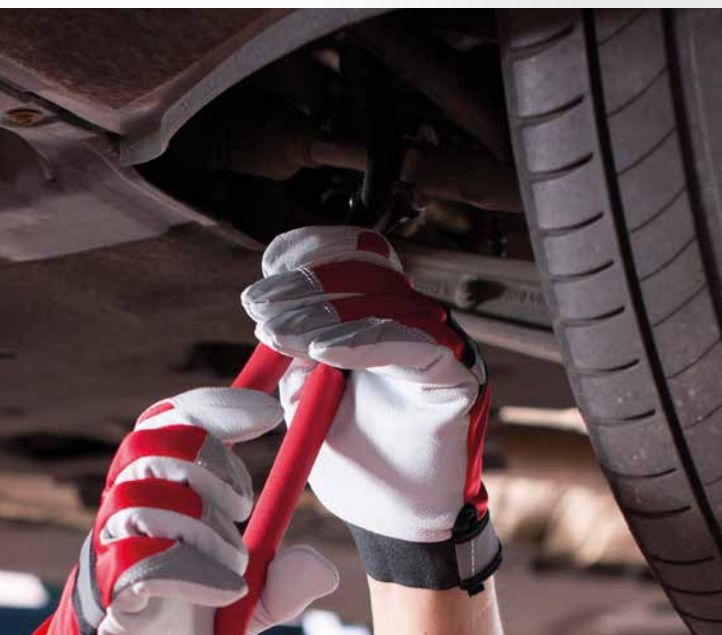

PERAČ DIJELOVA

· za pranje dijelova motora i pribora



No.	Tank capacity	Solvent capacity	Flow rate	Max. solvent temperature	Weight	
26961	90 l	45 l	10-12 l/min.	50°C	25 kg	1
26963	180l	150 l	20 l/min	50°C	42 kg	1



POSUDA ZA ULJE

Broj	specifikacija	
50020	300 ml	10



MAZALICA

· veliko punjenje
· kartuša
· punjenje dispenserom

Broj	specifikacija	
50022	400 ml	20



LJEVAK FLEKSIBILNI

Broj	
50017	10





POSUDA ZA ULJE

Broj	specifikacija	
50019	90 ml	1



KLJUČ ZA SKIDANJE

Broj	specifikacija	
50021	60 x 140 mm	6



LJEVAK FLEKOMIBILNI

Broj	specifikacija	
50025	60 x 140 mm	50



CRIJEVO SA SAMOUSISNIM

Broj	specifikacija	Ø	
50026	180 cm	15 mm	24



MAGNETNA POSUDICA

Broj	specifikacija	
26996	200 x 20 mm	1

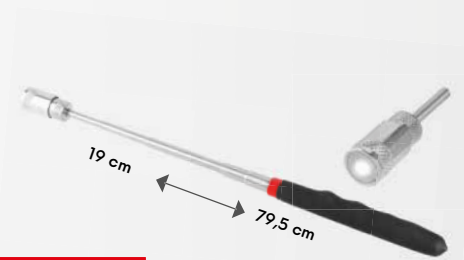

FESTA

TELESKOPSKI MAGNET - LED

Broj	specifikacija	
13294	3x LR44	6

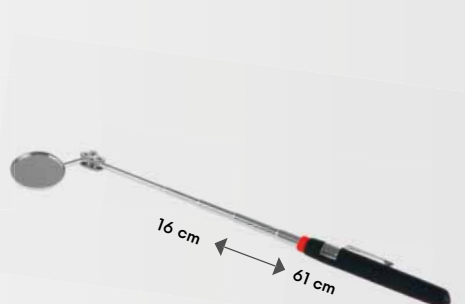

KONTROLNO OGLEDALO

Broj	specifikacija	
13290		20

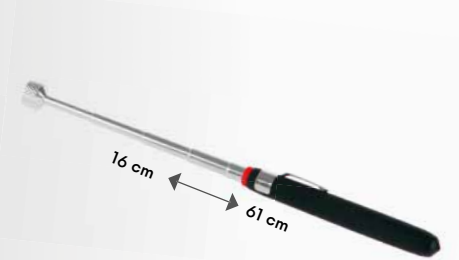

TELESKOPSKI MAGNET

Broj	specifikacija	
13293		20



POBIRAČ OTPADA

okretni za 90°

Broj	dužina	
61235	81 cm	12

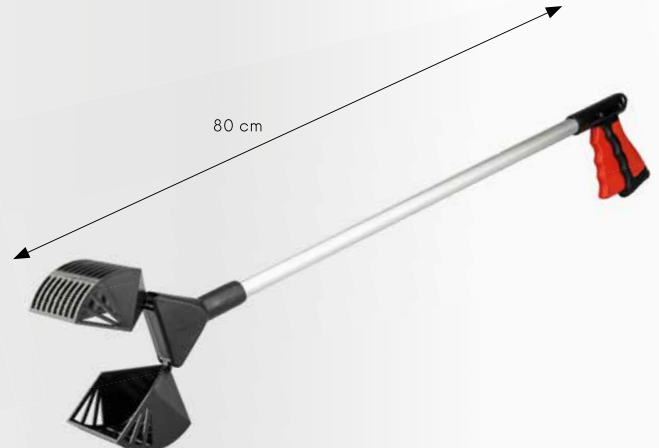

POBIRAČ OTPADA

max. 4 kg

Broj	
61236	12

FESTA



NEW



FESTA
INDUSTRY

RUČNA LED SVJETILJKA

3xLED	80, 200, 300 lm	3W COB LED	USB TYPE C	Li-ion 3.7V 0.8Ah	120 min
95 g	0-180°	IK07	IP54		

Broj: 37647 specifikacija: 3,7V 800 mAh





FESTA

RUČNA LED SVJETILJKA

Broj	specifikacija		
37645	200 mm	3 x AAA	12

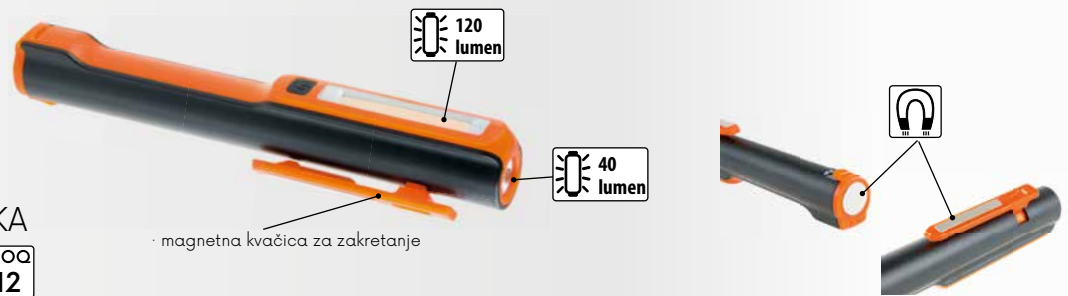

FESTA

NAGLAVNA LED SVJETILJKA

težina	47 g
izvor svjetlosti	1 x 1 W white LED + 2x red LED
baterija	3 x AAA
dimenzije	40 x 59 x 32 mm
vrijeme rasvjete	45 h
svjetlost	120 lumen
svjetlosna udaljenost	60 m (100% battery)
broj programa	4

5 positions					
Broj	specifikacija				
37641	2 vrste svjetla, bijela i crvena				1

FESTA

RUČNA LED SVJETILJKA

Broj	specifikacija		
37630	185 mm	2 x AA	



FESTA

RUČNA LED SVJETILJKA

Broj	specifikacija
37650	12



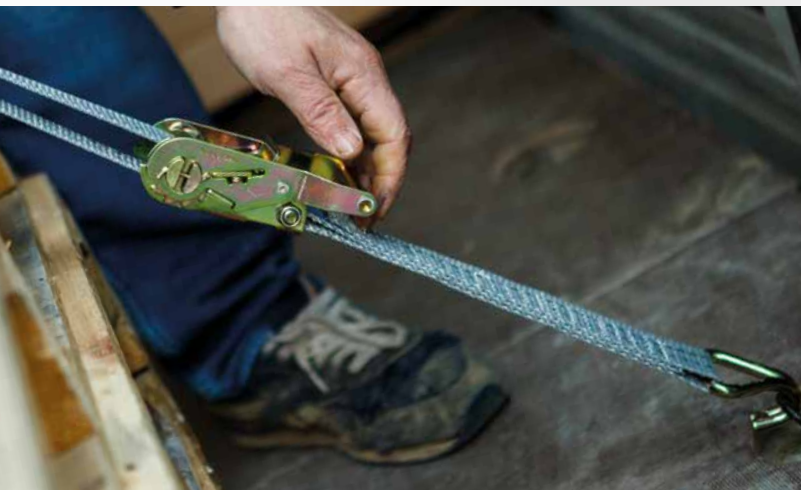

FESTA
ZATEZAČ
UNIVERZALNI



2x



Broj	širina	dužina	nosivost	kom	
51070	18 mm	2 m	100 kg	2	12

FESTA
ZATEZAČ
UNIVERZALNI



Broj	širina	dužina	nosivost	kom	
51071	25 mm	3,5 m	300 kg	1	8



FESTA
ZATEZAČ
UNIVERZALNI



Broj	širina	dužina	nosivost	kom	
51072	35 mm	4 m	500 kg	1	6



FESTA
ZATEZAČ
UNIVERZALNI



Broj	širina	dužina	nosivost	kom	
51040	25 mm	6 m	1000 kg	1	1
51041	35 mm	8 m	2000 kg	1	1
51042	35 mm	8 m	3000 kg	1	1
51043	50 mm	10 m	5000 kg	1	1



FESTA
ZATEZAČ
UNIVERZALNI



2x

Broj	širina	dužina	nosivost	kom	
51060	25 mm	5 m	750 kg	2	5



FESTA
ZATEZAČ
UNIVERZALNI



Broj	širina	dužina	nosivost	kom	
51065	50 mm	10 m	960 kg	1	6



FESTA
ZATEZAČ
UNIVERZALNI



Broj	širina	dužina	nosivost	kom	
51026	75 mm	5 m	3000 kg	1	4

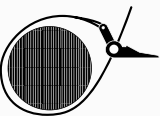

FESTA
ZATEZAČ
UNIVERZALNI



Broj	širina	dužina	nosivost	kom	
51032	25 mm	5 m	500 kg	1	6



FESTA
ZATEZAČ
UNIVERZALNI



Broj	širina	dužina	nosivost	kom	
51017	50 mm	6 m	480 kg	2	5
51018	50 mm	6 m	480 kg	1	10





ZATEZAČ UNIVERZALNI

Broj	širina	dužina	specifikacija	
51022	25 mm	5 m	s kukama	40
51023	50 mm	5 m	s kukama	12

FESTA
ZATEZAČ UNIVERZALNI

omekšani EVA jastučić

Broj	širina	dužina		kom
51046	38 mm	4 m		1
				20



ZATEZAČ UNIVERZALNI

Broj	širina	dužina	specifikacija	
51030	50 mm	6 m	s kukama	20
51034	50 mm	8 m	s kukama	10

ZATEZAČ UNIVERZALNI

2x

Broj	širina	dužina		kom
51020	25 mm	2,5 m		2
				100



ZATEZAČ UNIVERZALNI

PE

Broj	širina	dužina		kom
51045	25 mm	4 m		1
				50

GUMENI ZATEZAČ

2x

Broj	dužina	Ø		kom
51013	1,2 m	8 mm		2
				1



GUMENI ZATEZAČ

2x

Broj	dužina	kom	
51008	1 m	2	25

GUMENI ZATEZAČ

Broj	dužina	Ø		kom
51009	1 m	10 mm		1
				25



GUMENI ZATEZAČ

8x

- 2 x 0,4 m
- 2 x 0,6 m
- 1 x 0,8 m
- 1 x 1,0 m

Broj	dužina	Ø		kom
51011	1 m	8 mm		8
				10

GUMENI ZATEZAČ

2x

Broj	dužina	Ø		kom
51001	80 cm	10 mm		2
51002	100 cm	10 mm		2
51003	150 cm	10 mm		2
51004	200 cm	10 mm		2
				50



GUMENI ZATEZAČ

2x

Broj	dužina	Ø		kom
51007	1 m	8 mm		2
				25

GUMENI ZATEZAČ - PAUK

Broj	dužina	Ø	specifikacija	
51010	80 cm	8 mm	8 krakova	50



GUMENA MREŽA



Broj	dužina	širina	
51015	80 cm	120 cm	20

GUMA ZA VEZANJE



Broj	dužina	Ø	
51036	20 m	8 mm	10
51037	20 m	10 mm	6

REZERVNE KUKE



20x		
Broj	Ø	
51038	10 mm	30

ALU-KARABIN



ALU		MOQ 2	
Broj	Ø	dužina	
51200	6 mm	60 mm	2
51202	7 mm	70 mm	2
51201	8 mm	80 mm	2
51203	10 mm	100 mm	2

UŽE



Broj	dužina	Ø	
50915	5 m	8 mm	1
50916	25 m	8 mm	1
50917	25 m	10 mm	1
50918	25 m	12 mm	1
50919	25 m	14 mm	1

NAJLONSKO UŽE



Broj	dužina	Ø	
51055	80 m	1,5 mm	50
51056	50 m	2 mm	50
51057	20 m	4 mm	50

NAJLONSKO UŽE



Broj	dužina	Ø	
51050	50 m	8 mm	10
51051	50 m	10 mm	4

POLIPROPILENSKA ŠPAGA



Broj	težina	
50905	80 g	80
50906	100 g	100
50907	200 g	50

POLIPROPILENSKA ŠPAGA



Broj	težina	
50909	500 g (250 m)	1
50910	1000 g (500 m)	1
50911	5000 g (2500 m)	1

JUTENA ŠPAGA



Broj	težina	
50900	80 g (61 m)	1
50901	100 g (76 m)	1
50902	200 g (153 m)	1

ŠPAGA PREMAZANA VOSKOM



Broj	dužina	Ø	
50920	50 m	1 mm	80

ŽICA ZA FIKSIRANJE



1000x		
Broj	specifikacija	
42365	1,25 100 mm	1
42366	1,25 125 mm	1
42367	1,25 140 mm	1
42368	1,25 160 mm	1

VEZAČ ŽICE



Broj	specifikacija	
50052		12
50050		1

VEZAČ ŽICE



Broj	specifikacija	
50051		2

VEZICE

50x		EN 50146 nylon	
Broj	dužina	širina	
23875	120 mm	4,8 mm	1



VEZICE, U BOJI

100x		EN 50146 nylon	
Broj	dužina	širina	
23880	100 mm	2,5 mm	1
23882	150 mm	2,5 mm	1
23884	200 mm	3,6 mm	1



VEZICE, BIJELE

50x		EN 50146 nylon	
Broj	dužina	širina	
23850	120 mm	2,5 mm	1
23854	200 mm	3,6 mm	1
23856	250 mm	3,6 mm	1
23858	250 mm	4,8 mm	1
23860	300 mm	4,8 mm	1
23864	400 mm	4,8 mm	1
23866	500 mm	4,8 mm	1
23868	400 mm	7,6 mm	1
23870	500 mm	7,6 mm	1



VEZICE, CRNE

50x		EN 50146 nylon	
Broj	dužina	širina	
23810	120 mm	2,5 mm	1
23814	200 mm	3,6 mm	1
23816	250 mm	3,6 mm	1
23818	250 mm	4,8 mm	1
23820	300 mm	4,8 mm	1
23824	400 mm	4,8 mm	1
23826	500 mm	4,8 mm	1
23828	400 mm	7,6 mm	1
23830	500 mm	7,6 mm	1



VEZICA ZIDNA

10x			
Broj	dužina	širina	
23865	160 mm	7,5 mm	1



STRETCH FOLIJA

Broj	širina	dužina	debljina		
38095	500 mm	600 m	8 µm	transparent	1
38097	100 mm	150 m	20 µm	transparent	1
38096	500 mm	200 m	23 µm	black	1



PE VREĆA ZA ŠUTU

Broj	širina	dužina	debljina	objem	kom	
39194	500 mm	1100 mm	0,16 mm	100 l	1	10
39196	600 mm	1200 mm	0,16 mm	110 l	1	10
39198	700 mm	1100 mm	0,16 mm	120 l	1	10
39200	500 mm	1100 mm	0,20 mm	100 l	1	10
39202	600 mm	1200 mm	0,20 mm	110 l	1	10
39204	700 mm	1100 mm	0,20 mm	120 l	1	10



PE VREĆA ZA ŠUTU

Broj	širina	dužina	debljina	objem	kom	
39195	500 mm	1100 mm	0,16 mm	100 l	1	10
39197	600 mm	1200 mm	0,16 mm	110 l	1	10
39199	700 mm	1100 mm	0,16 mm	120 l	1	10
39201	500 mm	1100 mm	0,20 mm	100 l	1	10
39203	600 mm	1200 mm	0,20 mm	110 l	1	10
39205	700 mm	1100 mm	0,20 mm	120 l	1	10



VREĆE ZA SMEĆE

Broj	širina	dužina	debljina	kom	
38060	700 mm	1100 mm	0,08 mm	10	1
38063	700 mm	1100 mm	0,10 mm	3	1
38065	700 mm	1100 mm	0,20 mm	3	1



VREĆE ZA SMEĆE

Broj	širina	dužina	debljina	kom	
38050	500 mm	600 mm	0,04 mm	25	1
38052	600 mm	800 mm	0,04 mm	25	1
38054	700 mm	1100 mm	0,04 mm	25	1



VREĆE ZA SMEĆE

5x					
Broj	širina	dužina	debljina	kom	
38055	1200 mm	1000 mm	0,08 mm	5	1

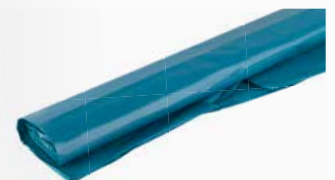



UPOZORAVAJUĆA TRAKA – STRUJA

Broj	širina	dužina	
38955	22 cm	20 m	1
38956	22 cm	50 m	1



UPOZORAVAJUĆA TRAKA – VODA

Broj	širina	dužina	
38957	22 cm	20 m	1
38958	22 cm	50 m	1



UPOZORAVAJUĆA TRAKA – PLYN

Broj	širina	dužina	
38959	22 cm	20 m	1
38960	22 cm	50 m	1



UPOZORAVAJUĆA TRAKA

Broj	specifikacija	dužina	
38944	ZAKAZ VSTUPU, SK	80 mm 250 m	8
38945	VSTUP ZAKAZÁN, CZ	80 mm 250 m	8



UPOZORAVAJUĆA TRAKA

Broj	dužina	
38948	80 mm 250 m	8

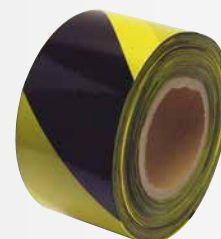

UPOZORAVAJUĆA TRAKA

Broj	dužina	
38946	80 mm 250 m	8



UPOZORAVAJUĆA TRAKA

Broj	dužina	specifikacija	
38947	48 mm 33 m	pravo	48
38961	48 mm 33 m	lijevo	48



TRAKA ZA OBILJEŽAVANJE

Broj	širina	dužina	material debljina	
38949	50 mm	50 m	0,15 mm	36

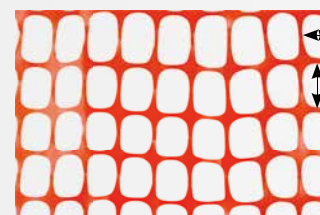

cca 3,5 cm

cca 6,5 cm

SIGURNOSNA OGRADA

140 g/m² UV STABLE

Broj	specifikacija	
42190	1,2 x 50 m HDPE 140g/m ²	1



KOMPLET TRAKA PVC

5x

Broj	širina	dužina	material debljina	
38931	19 mm	5 m	0,13 mm	100



TRAKA CRNA

Broj	širina	dužina	material debljina	
38932	19 mm	10 m	0,13 mm	10



TRAKA ŽUTO-ZELENA

Broj	širina	dužina	material debljina	
38925	19 mm	10 m	0,13 mm	10



TRAKA CRNA

Broj	širina	dužina	material debljina	
38968	19 mm	10 m	0,19 mm	10

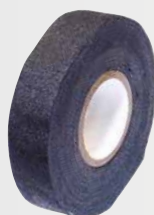

TEXTIL TRAKA

Broj	širina	dužina	
38927	19 mm	10 m	10



TEXTIL TRAKA

Broj	širina	dužina	
38980	48 mm	10 m	24
38981	48 mm	20 m	24



OBOSTRANO LJEPLJIVA TRAKA-PROZIRNA

Broj	širina	dužina	
38924	50 mm	10 m	1
38964	50 mm	25 m	1

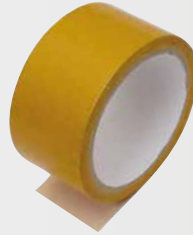

OBOSTRANO LJEPLJIVA TRAKA



Broj	širina	dužina	
38929	50 mm	10 m	1
38966	50 mm	25 m	1



OBOSTRANO LJEPLJIVA TRAKA



Broj	širina	dužina	
38990	19 mm	5 m	48
38991	25 mm	5 m	36



PROFESIONALNA DUCT TAPE TRAKA



Broj	širina	dužina	
38995	48 mm	25 m	24



ALU-TEKOMTIL TRAKA

Broj	širina	dužina	
38965	30 mm	10 m	1
38928	50 mm	10 m	72
38934	50 mm	45 m	24



PROFESIONALNA DUCT TAPE TRAKA



Broj	širina	dužina	
37275	48 mm	50 m	24



ZAŠTITNA TRAKA ZA ŽBUKU I GIPS



Broj	širina	dužina	
37271	38 mm	20 m	24
37270	48 mm	20 m	24
37272	48 mm	50 m	24



ZAŠTITNA TRAKA ZA PROZORE



Broj	širina	dužina	
37273	48 mm	50 m	24



ZAŠTITNA TRAKA



Broj	širina	dužina	
37263	38 mm	50 m	24
37264	48 mm	50 m	24

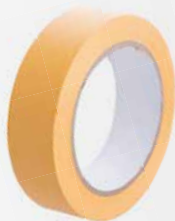

PVC LJEPLJIVA TRAKA



Broj	širina	dužina	
37266	30 mm	33 m	60
37267	38 mm	33 m	48
37268	50 mm	33 m	36



ZAŠTITNA TRAKA



Broj	širina	dužina	
37255	19 mm	50 m	12
37256	25 mm	50 m	12
37257	30 mm	50 m	7
37258	38 mm	50 m	6
37259	50 mm	50 m	6



PVC TRAKA



Broj	širina	dužina	
38942	50 mm	50 m	72



ALU TRAKA - KOD TOPLINSKE IZOLACIJE



Broj	širina	dužina	
38972	50 mm	50 m	1
38973	50 mm	100 m	1



ALU-SAMOLJEPIVA TRAKA

ALU

Broj	širina	dužina	
38963	48 mm	10 m	1
38943	48 mm	45 m	24



PROTUKLIZNA TRAKA

Broj	širina	dužina	debljina	
37280	25 mm	15 m	0,8 mm	72
37281	50 mm	15m	0,8 mm	36



SAMOVULKANIZIRAJUĆA TRAKA

Broj	širina	dužina	
38930	19 mm	5 m	100



SAMOLJEPIVA TRAKA (STAKLOLAMINAT)



Broj	širina	dužina	
38935	50 mm	20 m	60
38937	50 mm	45 m	36
38939	50 mm	90 m	24
38940	50 mm	153 m	24

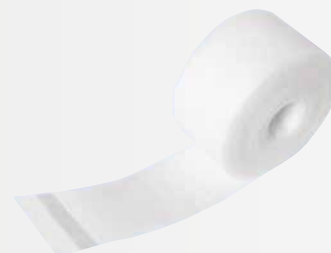

STAKLOLAMINATNI FILC (FIBERGLAS)



Broj	širina	dužina	
38941	50 mm	25 m	40



TEFLON TRAKA

TEFLON

Broj	širina	dužina	material debljina	
38969	19 mm	15 m	0,2 mm	10



TEFLON TRAKA

TEFLON

Broj	širina	dužina	material debljina	
38933	12 mm	10 m	0,075 mm	10



TEFLON VRPCA

za instalacije vode i plina

TEFLON

Broj	širina	dužina	
38926	2 mm	150 m	20

FESTA

TEFLON VRPCA

· 160m
· -20°C ... +130°C
· max 16 bar

NEW



Broj	specifikacija	
38975		1



DRŽAČ ZA LJEPLJIVU TRAKU

Broj		
38985		1



VELCRO TRAKA

Broj	specifikacija	
45471	12 mm x 5 m	1



FESTA

VELCRO TRAKA 3 KOM

3x

Broj	širina	dužina	
37295	20 mm	150 mm	1
37296	20 mm	200 mm	1
37297	20 mm	250 mm	1

NAPINJAČ

DIN 1480 Zn



Broj	specifikacija	
50100	5 x 70 mm	10
50101	6 x 90 mm	10
50102	8 x 125 mm	10
50103	10 x 150 mm	10

Broj	specifikacija	
50104	12 x 200 mm	10
50106	16 x 230 mm	10
50108	20 x 220 mm	10

KARABIN

DIN 5299 C Zn



Broj	specifikacija	
51204	4 mm	10
51205	5 mm	10
51206	6 mm	10
51207	7 mm	10
51208	8 mm	10

Broj	specifikacija	
51209	9 mm	10
51210	10 mm	10
51211	11 mm	10
51212	12 mm	10

ČLANAK

Zn



Broj	specifikacija	
51241	4 mm	10
51242	5 mm	10
51243	6 mm	10
51244	7 mm	10

Broj	specifikacija	
51245	8 mm	10
51246	10 mm	10
51247	12 mm	10

„S“ KUKA

Zn



Broj	specifikacija	
51271	3 mm	10
51272	4 mm	10
51273	5 mm	10
51274	6 mm	10

Broj	specifikacija	
51275	7 mm	10
51276	8 mm	10
51278	10 mm	10

OKASTA MATICA

DIN 5820 Zn



Broj	specifikacija	
51320	6 mm	10
51321	8 mm	10
51322	10 mm	10
51323	12 mm	10

Broj	specifikacija	
51324	14 mm	10
51325	16 mm	10
51327	20 mm	10

OKASTI VIJAK

DIN 5820 Zn



Broj	specifikacija	
51300	6 mm	10
51301	8 mm	10
51302	10 mm	10
51303	12 mm	10
51304	14 mm	10

Broj	specifikacija	
51305	16 mm	10
51306	18 mm	10
51307	20 mm	10
51308	22 mm	10



KARABIN

Zn

Broj	specifikacija	
51220	53 mm	10
51221	67 mm	10
51222	76 mm	10



OKRETNI KARABINER

Zn

Broj	specifikacija	
51225	3,8 mm	10
51226	4,5 mm	10
51227	6,0 mm	10



SPOJNICA ZA UŽAD I KABLOVE

DIN 5685 C Zn

Broj	specifikacija	
51341	Ø 10 mm	10



DRŽAČ KABLOVA

Zn

No.	specification	
51280	3 mm	10
51281	5 mm	10
51282	6 mm	10
51283	8 mm	10
51284	10 mm	10
51286	12 mm	10
51287	14 mm	10
51288	16 mm	10



OKNA ZA UŽAD

Zn

Broj	specifikacija	
51258	Ø 16 mm	10
51259	Ø 18 mm	10
51260	Ø 20 mm	10
51261	Ø 22 mm	10
51262	Ø 24 mm	10
51264	Ø 28 mm	10

DIZALICA LANČANA

No.	Capacity	Min. height	Lift height	No. of chain block	Chain thickness	Weight	
26700	500 kg	280 mm	3 000 mm	1	6 mm	7,5 kg	1
26701	1 000 kg	300 mm	3 000 mm	1	6 mm	9 kg	1
26702	2 000 kg	380 mm	3 000 mm	2	6 mm	12 kg	1



OPREMA ZA NAPINJANJE

Broj	specifikacija	
50035	2 t	6
50036	4 t	4



LANAC KRATKOG OKA

DIN 5685 A Zn

Broj	veličina oka	dužina	
51402	2 x 10 mm	110 m	1
51403	3 x 16 mm	60 m	1
51404	4 x 21 mm	40 m	1
51405	5 x 23 mm	30 m	1



Broj	size of eye	dužina	
51406	6 x 24 mm	18 m	1
51407	7 x 50 mm	16 m	1
51408	8 x 32 mm	10 m	1
51410	10 x 39 mm	10 m	1

LANAC KRATKOG OKA VICTOR

DIN 5686 Zn

Broj	Ø	dužina	
51430	1,4 mm	150 m	1
51431	1,6 mm	150 m	1
51432	1,8 mm	130 m	1



Broj	Ø	dužina	
51433	2,0 mm	118 m	1
51435	2,5 mm	70 m	1
51436	2,8 mm	50 m	1

LANAC DUGOG OKA

DIN 5685 C Zn

Broj	veličina oka	dužina	
51412	2 x 12 mm	80 m	1
51413	3 x 26 mm	60 m	1
51414	4 x 32 mm	38 m	1
51415	5 x 35 mm	32 m	1



Broj	veličina oka	dužina	
51416	6 x 43 mm	18 m	1
51417	7 x 50 mm	16 m	1
51418	8 x 54 mm	10 m	1
51420	10 x 65 mm	10 m	1

LANAC PLASTIKA



Broj	specifikacija	
51450	6 mm 25 m red-white	1



RUČNO VITLO

Zn

Broj	nosnost	dužina	
26720	300 kg	8 m	1
26705	450 kg	8 m	1
26721	500 kg	8 m	1
26722	800 kg	8 m	1
26706	900 kg	8 m	1
26707	1350 kg	8 m	1



REKLAMNI STALAK

Broj	specifikacija	
51196	stalak za lance	10
51197	stalak za žičanu užad	10
51198	stalak za lance	10
51199	stalak za žičanu užad	10

ŽIČANO UŽE (SAJLA)-
GALVANIZIRANO

Zn

Broj	Ø	dužina	
51100	Ø 1 mm	500 m	1
51102	Ø 1,5 mm	500 m	1
51103	Ø 2 mm	200 m	1
51104	Ø 3 mm	200 m	1
51105	Ø 4 mm	100 m	1
51106	Ø 5 mm	75 m	1
51107	Ø 6 mm	75 m	1
51130	Ø 8 mm	75 m	1
51131	Ø 10 mm	50 m	1
51132	Ø 12 mm	50 m	1

ŽIČANO UŽE (SAJLA)-
PLASTIFICIRANO

Zn

Broj	Ø	dužina	
51108	Ø 2/3 mm	200 m	1
51109	Ø 3/4 mm	100 m	1
51110	Ø 4/5 mm	75 m	1
51111	Ø 5/6 mm	50 m	1



ROSTFREI UŽE (SAJLA)

INOX

Broj	Ø	dužina	
51120	Ø 1 mm	300 m	1
51121	Ø 1,2 mm	300 m	1
51122	Ø 1,5 mm	300 m	1
51123	Ø 2 mm	200 m	1
51124	Ø 3 mm	200 m	1
51125	Ø 4 mm	100 m	1
51126	Ø 5 mm	75 m	1
51127	Ø 6 mm	75 m	1



NAVOJNA ŠIPKA

DIN 975 **Zn**

4.8 klasa tvrdoće

Broj	specifikacija	
55040	M 4 1 m	200
55050	M 5 1 m	150
55060	M 6 1 m	100
55080	M 8 1 m	50
55100	M 10 1 m	20
55120	M 12 1 m	20
55140	M 14 1 m	15
55160	M 16 1 m	15
55180	M 18 1 m	10
55200	M 20 1 m	10
55220	M 22 1 m	5
55240	M 24 1 m	5
55300	M 30 1 m	5



NAVOJNA ŠIPKA NEHRĐAJUĆA

DIN 976 **INOX** **4.8** klasa tvrdoće

Broj	specifikacija	
55315	M 12 1 m	20
55316	M 14 1 m	15
55317	M 16 1 m	15
55318	M 18 1 m	10
55319	M 20 1 m	10



before after



NAVOJNA ŠIPKA

DIN 975 **4.8** klasa tvrdoće

Broj	specifikacija	
55051	M 5 1 m	150
55181	M 18 1 m	10
55201	M 20 1 m	10
55221	M 22 1 m	5



FESTA

ALAT ZA DORADU ZAVRŠETKA NAVOJA

Ø 3 - 19 mm

1/4"

Broj	Specifikacija	
16321		5



MATICE

DIN 934 **Zn**

4.8 klasa tvrdoće

Broj	specifikacija	
55350	M 4 100 kom.	1
55351	M 5 100 kom.	1
55352	M 6 100 kom.	1
55353	M 8 100 kom.	1
55354	M 10 100 kom.	1
55355	M 12 100 kom.	1
55356	M 14 100 kom.	1
55357	M 16 100 kom.	1
55358	M 18 100 kom.	1
55359	M 20 10 kom.	1
55360	M 22 10 kom.	1
55361	M 24 10 kom.	1
55362	M 30 10 kom.	1



PODLOŠKA

DIN 440R **Zn**



Broj	specifikacija	
55331	M 5 100 kom.	1
55332	M 6 100 kom.	1
55333	M 8 100 kom.	1
55334	M 10 100 kom.	1
55335	M 12 100 kom.	1
55336	M 14 100 kom.	1
55337	M 16 100 kom.	1
55339	M 20 10 kom.	1
55340	M 22 10 kom.	1
55341	M 24 10 kom.	1
55342	M 30 10 kom.	1



FESTA

KUTIJA ORGANIZATOR



Broj	Specifikacija	
55650	375 x 290 x 67 mm	1



SET KUTIJA + VIJCI ZA DRVO

2000x

Broj	specifikacija	
55640	2000 kom	1



kom	
350	3,0 x 16 mm
280	3,0 x 20 mm
220	3,0 x 25 mm
250	3,5 x 20 mm
240	3,5 x 25 mm
180	3,5 x 3, mm
280	4,0 x 16 mm
80	4,0 x 30 mm
40	4,0 x 40 mm
30	4,0 x 50 mm
25	5,0 x 50 mm
25	5,0 x 60 mm

VIJCI ZA DRVO + TIPLE

vijci za drvo

kom	
40	3,5 x 30 mm
25	4,0 x 40 mm
12	5,0 x 50 mm
8	6,0 x 60 mm

tiple

kom	
40	5 x 25 mm
25	6 x 30 mm
12	8 x 40 mm
8	10 x 50 mm

170x

Broj	specifikacija	
55645		1



SET KUTIJA + VIJCI ZA DRVO

310x

kom	
60	3,0 x 12 mm
50	3,0 x 16 mm
40	3,0 x 20 mm
50	3,5 x 20 mm
40	3,5 x 30 mm
25	4,0 x 30 mm
20	4,0 x 40 mm
15	5,0 x 50 mm
10	5,0 x 60 mm

Broj	specifikacija	
55642		1





ZAŠTITNE NAOČALE

CE EN
166

Broj specifikacija 
50510 10



ZAŠTITNE NAOČALE

CE EN
166

Broj specifikacija 
50514 10



ZAŠTITNE NAOČALE

 podesiva duljina okvira

CE EN
166

Broj specifikacija 
50511 12



ZAŠTITNE NAOČALE

CE EN
170

Broj specifikacija 
50512 tamno 12



ZAŠTITNE NAOČALE

CE EN
166

Broj specifikacija 
50513 1



ANTIFON – ZAŠTITNE SLUŠALICE

CE EN
352

27
dB

Broj specifikacija 
50563 1



ANTIFON – ZAŠTITNE SLUŠALICE

CE EN
352

27
dB

Broj specifikacija 
50564 1



ŠTITNIK ZA LICE PE

CE EN
166

Broj specifikacija 
50556 10



ŠTITNIK ZA LICE MREŽASTI

CE
EN 1731

Broj 
50562 10



ČEPIĆI ZA UŠI

Broj specifikacija 
50560 100



ČEPIĆI ZA UŠI

Broj specifikacija 
50559 100



ZAŠTITNA KACIGA CLIMAX

CE EN
397

MADE IN
EU

Broj	specifikacija	
50550	plava	30
50551	crvena	30
50553	bijela	30
50554	žuta	30



REFLEKTIRAJUĆI PRSLUK

CE EN
20471

Broj	specifikacija	
50570	narančasta	100
50571	žuta	100



KOLICA ZA KLEČANJE

Broj	specifikacija	
37135		1



FESTA

ŠTITNICI ZA KOLJENA

Broj	specifikacija	
37145	gel	8



FESTA

ŠTITNICI ZA KOLJENA

Broj	specifikacija	
37140	gel	12



FESTA

ŠTITNICI ZA KOLJENA

Broj	specifikacija	
37144	gel	12



FESTA

ŠTITNICI ZA KOLJENA

Broj	specifikacija	
37143		12



FESTA

ŠTITNICI ZA KOLJENA

Broj	specifikacija	
37142	komfort	20



ŠTITNICI ZA KOLJENA

Broj	specifikacija	
37139	neopren	10



ŠTITNICI ZA KOLJENA

Broj	specifikacija	
37141		6





KOŽNE RUKAVICE, POJAČANE

· S oblogom u dlanu



Broj	specifikacija	
50518	veličina 11"	12



KOŽNE RUKAVICE, POJAČANE

· S oblogom u dlanu



Broj	specifikacija	
50519	veličina 10,5"	12



KOŽNE RUKAVICE



Broj	specifikacija	
50520	veličina 10,5"	12



PAMUČNE RUKAVICE SA PVC TOČKAMA

Broj	specifikacija	
50524	veličina 10"	12



PAMUČNE RUKAVICE PRESVUČENE PVC-OM



Broj	specifikacija	
50525	veličina 10" - dužina 35 cm	12



POLIESTERSKE RUKAVICE SA PVC TOČKAMA

· Sa pvc točkama

Broj	specifikacija	
50526	veličina 10"	12



PAMUČNE RUKAVICE PRESVUČENE LATEXOM



Broj	specifikacija	
50522	veličina 10"	12



RUKAVICE PRESVUČENE NITRILOM



Broj	specifikacija	
50533	veličina 10"	12



RUKAVICE PRESVUČENE GUMENOM PJENOM

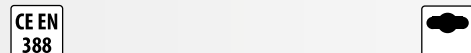

Broj	specifikacija	
50535	veličina 8"	12
50536	veličina 9"	12
50537	veličina 10"	12



RUKAVICE PRESVUČENE GUMENOM PJENOM

· Sa pvc točkama



Broj	specifikacija	
50539	veličina 10"	12



ZIMSKE RUKAVICE PRESVUČENE LATEKSOM



Broj	specifikacija	
50529	veličina 10"	12



RUKAVICE ZA VRT



Broj	specifikacija	
50557	veličina 7"	12
50558	veličina 8"	12
50549	veličina 9"	12



PAMUČNE RUKAVICE SA PVC TOČKAMA

· Sa pvc točkama

Broj	specifikacija	
50531	veličina 9"	12



RUKAVICE NAJLON-KOZJA KOŽA



Broj	specifikacija	
50541	veličina 9"	12
50542	veličina 10"	12



RUKAVICE NAJLON-SVINJSKA KOŽA



Broj	specifikacija	
50544	veličina 10"	12



RUKAVICE MOČENE U POLIURETANU



Broj	specifikacija	
50527	veličina 10"	12



KOŽNE VARILAČKE RUKAVICE



Broj	specifikacija	
50540	veličina 11"	12



JEDNOKRATNE VINYL RUKAVICE

· bistro, bez praha



Broj	specifikacija	
50532	veličina 9"	100



ZAŠTITNA MASKA



Broj	specifikacija	
50500	FFP2 bez respiratora	30



ZAŠTITNA MASKA S RESPIRATOROM



Broj	specifikacija	
50503	FFP2 sa respiratorom	20



JEDNOKRATNO ZAŠTITNO ODIJELO S KAPULJAČOM

Broj	specifikacija	
50585	veličina M	1
50586	veličina L	1
50587	veličina XL	1
50588	veličina XXL	1



ZAŠTITNA VARILAČKA PREGAČA



Broj	specifikacija	
50555	koža	1

· Visoka kvaliteta metalne ručke, pod stavljena

· udoban odvojivi remen



· Remeni za suhim cickom za privrščivanje dugackog alata

· pojačana unutarnja konstrukcija

· 18 džepova

FESTA**TORBA ZA ALAT S METALNOM RUČKOM**

Broj	šifina	dužina	dubina	
37331	280 mm	490 mm	230 mm	2

**FESTA****TORBA ZA ALAT**

Broj	šifina	dubina	dubina	
37332	480 mm	290 mm	250 mm	1

FESTA**TORBA ZA ALAT**

Broj	šifina	dubina	dubina	
37330	610 mm	400 mm	270 mm	5

FESTA**FESTA****TORBICA ZA ALATE**

· pojačani džepovi



Broj	ecifikacija	
37325		10

**FESTA****TORBICA ZA ALATE**

· pojačani džepovi



Broj	ecifikacija	
37326		12

**FESTA****NYLON REMEN**

Broj	ecifikacija	
37328	145 cm	20



FESTA

MONTAŽNI REMEN SA TORBOM ZA ALAT

· 14 džepova + spona



Broj	dužina	šifina	
37311	120 cm	6 cm	1



FESTA

NYLON REMEN



Broj	dužina	šifina	
37310	120 cm	6 cm	1



FESTA

FUTROLA ZA ALAT

· 8 džepova



Broj	šifina	dubina	
37320	300 mm	250 mm	1



FESTA

FUTROLA ZA ALAT

· 4 džepova



Broj	šifina	dubina	
37321	350 mm	300 mm	1



FESTA

RADNI PRSLUK



Broj	ecifikacija	
37350		20



FESTA

POJAS ZA ALAT, KOŽA



Broj	specifikacija	
37302	6 džepova	50
37303	11 džepova	25



POJAS ZA ALAT, KOŽA



Broj	specifikacija	
37300	6 džepova	50
37301	11 džepova	25



FESTA



KOŽNA TORBA PROFI



Broj	dubina	dužina	dubina	
37342	270 mm	430 mm	180 mm	1



KOŽNA TORBA ZA ELEKTRIČARE



Broj	dubina	dužina	dubina	
37341	260 mm	430 mm	200 mm	1



KOŽNA TORBA S OJAČANIM DNOM



Broj	dubina	dužina	dubina	
37340	240 mm	430 mm	150 mm	1



TORBICA PROFI



Broj	dubina	dužina	dubina	
37344	250 mm	300 mm	130 mm	1



TORBA S OJAČANIM DNOM

Broj	dubina	dužina	dubina	
37343	240 mm	430 mm	150 mm	1



TORBA ZA ELEKTRIČARE

Broj	dubina	dužina	dubina	
37345	270 mm	430 mm	180 mm	1

DRŽAČ ALATA "O"



Broj	specifikacija	
37308		20



DRŽAČ ALATA "U"



Broj	specifikacija	
37309		20





FESTA

CILINDAR BRAVE,
NIKAL



Broj	specifikacija	
23001	65 mm · 175 g	10



CILINDAR BRAVE,
NIKAL



Broj	specifikacija	
23000	65 mm · 75 g	15



FESTA

LOKOT



Broj	specifikacija	
23261	25 mm	6
23262	32 mm	12
23263	38 mm	6
23264	45 mm	6
23265	52 mm	12
23266	63 mm	6



FESTA

LOKOT MESING
POJAČANI



Broj	specifikacija	
23125	25 mm	12
23130	30 mm	12
23135	35 mm	12
23140	40 mm	12
23150	50 mm	12
23160	60 mm	12



FESTA

LOKOT MESING
POJAČANI



Broj	specifikacija	
23310	30 mm	10
23311	40 mm	10
23312	50 mm	6



FESTA

LOKOT PRODUŽENI



Broj	specifikacija	
23211	25 mm	12
23212	32 mm	12
23213	38 mm	6
23214	45 mm	6
23215	52 mm	6



FESTA

LOKOT MESING
POJAČANI



Broj	specifikacija	
23274	60 mm	6
23275	70 mm	12

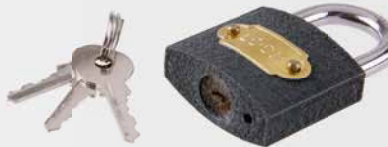

LOKOT POJAČANI



Broj	specifikacija	
23220	25 mm	6
23225	30 mm	6
23232	32 mm	6
23240	40 mm	6
23250	50 mm	6
23260	60 mm	6



LOKOT MESING



Broj	specifikacija	
23020	20 mm	12
23025	25 mm	12
23030	30 mm	12
23035	35 mm	12
23040	40 mm	12
23050	50 mm	12
23060	60 mm	12





LOKOT MESING PRODUŽENI

3x

Broj	specifikacija	
23070	40 mm	12

LOKOT ČELIK

3x

Broj	specifikacija	
23010	50 mm	6



VODO- OTPORNI LOKOT

3x

Broj	specifikacija	
23005	40 mm	6
23006	50 mm	6



FESTA

LOKOT ZA BICIKL

Broj	specifikacija	
23288	120 cm x Ø 10 mm	1



FESTA

LOKOT ZA BICIKL

Broj	specifikacija	
23287	65 cm x Ø 10 mm	1



FESTA

LOKOT ZA BICIKL

2x

Broj	specifikacija	
23290	120 cm x Ø 8 mm	1
23291	150 cm x Ø 8 mm	1
23292	180 cm x Ø 8 mm	1



LOKOT ZA BICIKL

2x

Broj	specifikacija	
23282	55 cm x Ø 8 mm	50
23284	65 cm x Ø 8 mm	50



LOKOT SA BROJEVIMA

Broj	specifikacija	
23281		20





FESTA

**SEF
S ELEKTRONSKOM BRAVOM**



- Vrsta brave: elektronska, mehanička
- Sigurnosni ključ
- Dimenzije 350x250x250mm
- Težina 10 kg



Broj	specifikacija	
23270		1

FESTA

**PLASTIČNI PRIVJESAK ZA
KLJUČEVE SA ALKOM**

100x



Broj		
23391		50

**PLASTIČNI PRIVJESAK ZA
KLJUČEVE SA ALKOM**

100x



Broj		
23390		1

BLAGAJNA



Broj	širina	dubina	visina	
70120	125 mm	95 mm	60 mm	1

ZASUN ZGLOBNI

Broj	specifikacija	
51514	100 mm	25
51515	120 mm	25
51516	140 mm	25
51517	160 mm	25



ZASUN

Broj	specifikacija	
51510	100 mm	12
51511	120 mm	12
51512	140 mm	12
51513	160 mm	12



KUTIJA ZA KLJUČEVE



Broj	specifikacija	
70140	250 x 180 x 80 mm - za 48 ključeva	12
70141	300 x 230 x 90 mm - za 90 ključeva	8

BLAGAJNA



Broj	širina	dubina	visina	
70121	152 mm	118 mm	80 mm	36

BLAGAJNA



Broj	širina	dubina	visina	
70122	200 mm	160 mm	90 mm	20

BLAGAJNA



Broj	širina	dubina	visina	
70123	250 mm	180 mm	90 mm	16



BLAGAJNA



Broj	širina	dubina	visina	
70124	300 mm	240 mm	90 mm	10



BLAGAJNA



Broj	širina	dubina	visina	
70125	370 mm	280 mm	90 mm	8



POŠTANSKI SANDUČIĆ



Broj	boja	širina	visina	dubina	
70101	bijela	290 mm	360 mm	105 mm	5
70100	smeđaa	290 mm	360 mm	105 mm	5



POŠTANSKI SANDUČIĆ



Broj	boja	širina	visina	dubina	
70102	bijela	310 mm	260 mm	90 mm	10
70103	smeđa	310 mm	260 mm	90 mm	10



POŠTANSKI SANDUČIĆ



Broj	boja	širina	visina	dubina	
70105	smeđa	310 mm	360 mm	90 mm	5



POŠTANSKI SANDUČIĆ



Broj	boja	širina	dubina	visina	
70108	bijela	370 mm	134 mm	364 mm	5



POŠTANSKI SANDUČIĆ



Broj	boja	širina	dubina	visina	
70107	rost frei	360 mm	100 mm	520 mm	6



POŠTANSKI SANDUČIĆ



Broj	boja	širina	dubina	visina	
70106	rost frei	360 mm	100 mm	360 mm	5



POŠTANSKI SANDUČIĆ



Broj	boja	širina	dubina	visina	
70109	rost frei	310 mm	90 mm	260 mm	6



POŠTANSKI SANDUČIĆ



Broj	boja	širina	dubina	visina	
70110	rost frei	310 mm	90 mm	360 mm	6

ANALOGNA VAGA

Broj	max.		
24260	50 kg	10	



RUČNA VAGA

Broj	max.	
24212	12,5 kg	12
24225	25 kg	6
24250	50 kg	6
24255	100 kg	6
24258	150 kg	6



PINCETA S LED SVJETLOM

Broj	specifikacija	
50005	95 mm	8



SET PINCETA

Broj	specifikacija	
50004		1

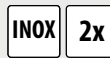

MIŠOLOVKA DRVENA

Broj	specifikacija	
70221	90 x 45 mm drven	1



MIŠOLOVKA PLASTIČNA

Broj	specifikacija	
70220	97 x 47 mm plastika	48



ČISTAČ ODVODA

· mogućnost upotrebe s bušilicom

Broj	dužina	Ø	
50014	6 m	6 mm	6



ČISTAČ ODVODA

Broj	dužina	
50010	3 m	10
50011	5 m	5
50012	10 m	3
50013	15 m	4



ČISTAČ ODVODA

Broj	dužina	Ø	
50009	3 m	5 mm	40



PUMPA ZA ČIŠĆENJE ODVODA

Broj	dužina	Ø	
50015	385 mm	65 mm	30



ELEKTRIČARSKA TRAKA

Broj	dužina	Ø	
51181	8 m	5 mm	25
51182	10 m	5 mm	25





GLADILICE, ŽLICE I LOPATICE



ZIDARSKÉ FANGLE



STRUGALICE



GLADILICE, ROVNALICE, BRUSNE MREŽICE, DRŽAČI



GLADILICE PLASTIČNE



MJEŠALICE



GRAĐEVINSKE MJEŠALICE



CIJEV ZA NASIPAVANJE ŠUTE



GRAĐEVINSKA KOLICA



IZRAVNAVAJUĆA LETVA



NOSAČ ZA RUBNI KAMEN



REZAČI PLOČICA



PRIBOR ZA KERAMIČARE



NIVELACIJSKI PRIBOR



STROJ ZA REZANJE STIRO-PORA



ALATI ZA SUHOZID



PB PLAMENIK I REGULATOR TLAKA



ZIDARSKÉ POSUDE



PIŠTOLJI ZA SILIKON



PIŠTOLJI ZA PU PJENE



LIČILAČKI PRIBOR



PE ZAŠTITNA FOLIJA



LJESTVE



POTPORNI NOSAČI, VRATA ZA DIMNJAK

GRAĐEVINSKI ALATI

242 - 307





FESTA

FESTA

GLADILICA
ROST FREI
280 X 130 MM

gumena ručka



Broj	specifikacija	
31140	ravna	10

FESTA

GLADILICA
ROST FREI
280 X 130 MM

gumena ručka



Broj	specifikacija	
31148	ravna	10

FESTA

GLADILICA
ROST FREI
280 X 130 MM
NAZUBLJENA

gumena ručka



Broj	specifikacija	
31146	Ø 16	10

FESTA

GLADILICA
ROST FREI
280 X 130 MM
NAZUBLJENA

gumena ručka



Broj	specifikacija	
31141	e 4	10
31142	e 6	10
31143	e 8	10

Broj	specifikacija	
31144	e 10	10
31145	e 12	10

FESTA

GLADILICA
ROST FREI
280 X 130 MM
NAZUBLJENA



Broj	specifikacija	
31101	e 4	10
31111	e 6	10
31121	e 8	10

Broj	specifikacija	
31131	e 10	10
31132	e 12	10

FESTA

GLADILICA
ROST FREI
280 X 130 MM



Broj	specifikacija	
31091	ravna	10

FESTA

GLADILICA
ROST FREI
280 X 130 MM



Broj	specifikacija	
31011	ravna	10

FESTA

GLADILICA
ROST FREI
280 X 130 MM
NAZUBLJENA



Broj	specifikacija		Broj	specifikacija	
31021	e 4	10	31051	e 10	10
31031	e 6	10	31053	e 12	10
31041	e 8	10			

GLADILICA
ROST FREI
270 X 125 MM



Broj	specifikacija	
31005	ravna	25

GLADILICA
ROST FREI
270 X 125 MM
NAZUBLJENA



Broj	specifikacija		Broj	specifikacija	
31006	e 4	24	31008	e 8	24
31007	e 6	24	31009	e 10	24

FESTA

GLADILICA
ROST FREI
360 X 130 MM



Broj	specifikacija	
31151	ravna	10

FESTA

GLADILICA
ROST FREI
360 X 130 MM



Broj	specifikacija	
31150	ravna	10

FESTA

GLADILICA
ROST FREI
480 X 130 MM



Broj	specifikacija	
31082	ravna	10

FESTA

GLADILICA
ROST FREI
680 X 130 MM



Broj	specifikacija	
31155	ravna	10

FESTA

GLADILICA
ROST FREI
NAZUBLJENA
500 X 130 MM



Broj	specifikacija	
31052	e 4	10
31061	e 6	10
31062	e 8	10
31071	e 10	10
31072	e 12	10

FESTA

GLADILICA
ROST FREI
500 X 130 MM



Broj	specifikacija	
31081	ravna straight	10



FESTAŽLICA ROST FREI
SA GUMENOM RUČKOM

INOX · gumena ručka

Broj	specifikacija	
31232	120 mm	10
31233	140 mm	10

**FESTA**

ŽLICA ROST FREI

INOX

Broj	specifikacija	
31220	120 x 80 mm	10
31221	140 x 80 mm	10

**FESTA**ŽLICA ROST FREI
SA GUMENOM RUČKOM

INOX · gumena ručka

Broj	specifikacija	
31334	160 x 100 mm	10

**FESTA**

ŽLICA ROST FREI

INOX

Broj	specifikacija	
31343	160 x 100 mm	10

**FESTA**ŽLICA ROST FREI
SA GUMENOM RUČKOM

INOX · gumena ručka

Broj	specifikacija	
31360	40 mm	10
31380	60 mm	10
31390	80 mm	10

**FESTA**

ŽLICA ROST FREI

INOX

Broj	specifikacija	
31362	40 mm	10
31382	60 mm	10

**FESTA**ŽLICA ROST FREI
SA GUMENOM RUČKOM

INOX · gumena ručka

Broj	specifikacija	
31330	140 x 50 mm	10
31340	160 x 60 mm	10

**FESTA**

ŽLICA ROST FREI

INOX

Broj	specifikacija	
31332	140 x 50 mm	10
31341	160 x 60 mm	10

**FESTA**KUTNA ŽLICA ROST FREI SA
GUMENOM RUČKOM

INOX · gumena ručka

Broj	specifikacija	
31280	80 x 60 x 60 mm	10

**FESTA**KUTNA ŽLICA
ROST FREI

INOX

Broj	specifikacija	
31281	80 x 60 x 60 mm	10

**FESTA**KUTNA ŽLICA ROST FREI SA
GUMENOM RUČKOM

INOX · gumena ručka

Broj	specifikacija	
31270	80 x 60 x 60 mm	10

**FESTA**KUTNA ŽLICA
ROST FREI

INOX

Broj	specifikacija	
31271	80 x 60 x 60 mm	10



FESTA

ŽLICA ROST FREI
SA GUMENOM RUČKOM

INOX · gumena ručka

Broj	specifikacija	
31320	140 x 75 mm	10



FESTA

ŽLICA ROST FREI

INOX

Broj	specifikacija	
31322	140 x 75 mm	10



FESTA

ŽLICA ROST FREI

INOX

Broj	specifikacija	
31218	180 mm e 6	12



FESTA

LOPATICA ROST-FREI SA
GUMENOM RUČKOM

· gumena ručka

INOX

Broj	specifikacija	
31510	40 mm	10
31511	60 mm	10
31512	80 mm	10



FESTA

STRUGALICA,
GUMENA RUČKA

· gumena ručka
· debela oštrica

INOX

Broj	specifikacija	
32173	75 mm	10



FESTA

STRUGALICA

· držalo 52010
· debela oštrica

INOX

Broj	specifikacija	
32170	100 mm	12



FESTA

LOPATICA,
SA BITOM

· gumena ručka

INOX

Broj	specifikacija	
31455	150 mm	12
31456	200 mm	12

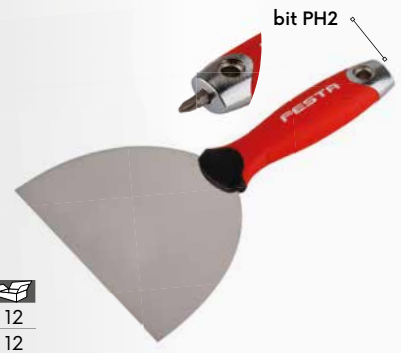

FESTA

LOPATICA ROST-FREI
SA GUMENOM RUČKOM

INOX

Broj	specifikacija	
31517		10



FESTA

LOPATIČA
POJAČANA

· gumena ručka

INOX

Broj	specifikacija	
31505	200 mm	5
31506	250 mm	5
31507	300 mm	5



**FESTA****STRUGALICA**

· debela oštrica

INOX

Broj	širina	dužina	
32174	100 mm	500 mm	1

FESTA**LOPATICA ROST FREI****INOX**

R.s.	leirás	
31461	40 mm	12
31471	60 mm	12
31481	80 mm	12
31491	100 mm	12
31467	120 mm	12
31468	140 mm	12

**FESTA****LOPATICA, ROST FREI****INOX**

Broj	specifikacija	
31498	150 mm	12
31499	200 mm	12
31500	100 mm	12

**LOPATICA TVRDA, ROST FREI****INOX**

MADE IN EU

Broj	specifikacija	
31493	40 mm	20
31494	60 mm	20
31495	80 mm	20
31496	100 mm	20

**LOPATICA ŽELJEZNA**

R.s.	leirás	
32176	30 mm	12
32186	40 mm	12
32196	50 mm	12
32206	60 mm	12
32216	80 mm	12
32226	100 mm	12
32234	125 mm	12

**LOPATICA ŽELJEZNA****3x**

Broj	specifikacija	
32240	30, 50, 80 mm	10

**FESTA****LOPATICA ŽELJEZNA**

Broj	specifikacija		Broj	specifikacija	
32161	30 mm	10	32171	90 mm	10
32162	40 mm	10	32166	100 mm	10
32163	50 mm	10	32172	110 mm	10
32164	60 mm	10	32167	120 mm	10
32169	70 mm	10	32168	140 mm	10
32165	80 mm	10			

**VALJAK ZA NANOŠENJE ŽBUKE**

- ručka 180 mm - 52630
- ručka 250 mm - 52625
- duga ručka 52010, 52011, 52012, 52020, 52030



Broj	Specifikacija			
52611	250 mm	Ø 8 mm	Ø 48 mm	50
52612	180 mm	Ø 8 mm	Ø 48 mm	10

FESTA

LOPATICA
ZA BRTVLJENJE NA
CIJELOJ POVRŠINI

INOX

R.s.	Ieírás	
31555	35 cm	1
31556	45 cm	1
31557	60 cm	1
31558	80 cm	1
31559	100 cm	1



FESTA

TELESKOP ŠTAP

navoj za 31610, 34203

Broj	Specifikacija	
52011	88 - 140 cm	1



FESTA

DRŽAČ LOPATICE
ZA BRTVLJENJE
CIJELE POVRŠINE

· za 31555 - 31559
· teleskop štap 52010, 52011, 52012, 52020, 52030

Broj	Specifikacija	
31610		1

LOPATICA
NEHRĐAJUĆI ČELIK
S POJAČANJEM

INOX

MADE IN
EU

Broj	specifikacija	
31520	400 mm	1
31521	500 mm	
31522	600 mm	



držano 61254



31523



31524

LOPATICA NEHRĐAJUĆI ČELIK
S POJAČANJEM - PRIBOR

MADE IN
EU

Broj	specifikacija	
31523	držač ALU	1
31524	plastični držač	1

LOPATICA
FASADNA,
ROST FREI

INOX

Broj	specifikacija	
31552	400 mm	10
31553	600 mm	10



LOPATICA
FASADNA,
ROST FREI

INOX

MADE IN
EU

Broj	specifikacija	
31541	250 mm	1
31551	250 mm uža	1

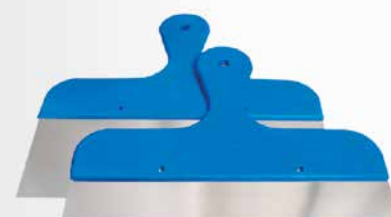

GLADILICA
METALNA

Broj	specifikacija	
32062	280 x 160 mm	10
32060	500 x 140 mm	5

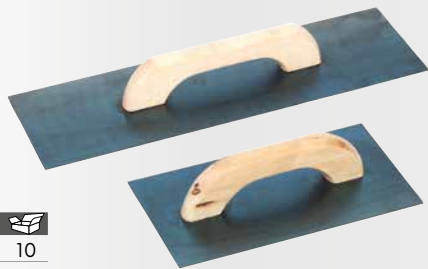
GLADILICA
METALNA

Broj	specifikacija	
32064	500 x 90 mm	5
32066	550 x 140 mm	5

ZIDARSKA
ŽLICA

Broj	specifikacija	
32015	160 x 130 mm	10
32014	180 x 130 mm	10
32016	200 x 140 mm	10

ŽLICA
ŽELJEZNA

Broj	specifikacija	
32001	160 x 110 mm	10
32002	160 x 130 mm	10
32003	180 x 130 mm	10
32013	200 x 140 mm	10

ŽLICA
ŽELJEZNA
OBLA

Broj	specifikacija	
32018	160 x 110 mm	10



ŽLICA

Broj	specifikacija	
32024	140 x 80 mm	12



ŽLICA

Broj	specifikacija	
32020	140 x 65 mm	12
32021	140 x 40 mm	12



ŽLICA

Broj	specifikacija	
32026	140 x 85 mm	12



FESTA

ZIDARSKA
FANGLA,
ROST FREI

INOX

Broj	specifikacija	
32285	Ø 180 mm	1



FESTA

ZIDARSKA
FANGLA

Zn

Broj	specifikacija	
32265	Ø 180 mm	10



FESTA

ZIDARSKA
FANGLA

Broj	specifikacija	
32273	Ø 160 mm	10
32283	Ø 180 mm	10
32293	Ø 215 mm	10

ZIDARSKA
FANGLA,
PLASTIKA

Broj	specifikacija	
32270	Ø 160 mm	1



ZIDARSKA FANGLA

drška 61215

Broj	specifikacija	
32302	Ø 180 mm	1
32313	Ø 215 mm	1
32301	Ø 235 mm	1



ZIDARSKA FANGLA ZA DRŽALO

drška 61200, 61201

Broj	specifikacija	
32268	Ø 215 mm	1
32269	Ø 235 mm	1
32296	Ø 215 mm	1



GRABLJE ZA BETON S DRŽALOM

Broj	specifikacija	
60100	grablje za beton 295 x 150 mm	24
61169	grablje za beton s držalom 160 cm	3
61218	držalo 160 cm	5



ZIDARSKA FANGLA SA DRŽALOM

MOQ 3

Broj	specifikacija	
32295	Ø 180 mm dužina držala 160cm	3
32297	Ø 215 mm dužina držala 160cm	3
32298	Ø 235 mm dužina držala 160cm	3



STRUGALICA ZA YTONG

Broj	specifikacija	
32037	600 mm	1



KUTNIK ZA REZANJE POROBETONA

Broj	specifikacija	
32038	270 x 270 x 270 mm	1



ŽLICA ZA YTONG

Broj	specifikacija	
32089	150 mm	1



FESTA

SJEKAČ ZA BETON

CrV	Broj	specifikacija	šifra hrotu	
	19406	300 mm	25 mm	5
	19407	400 mm	30 mm	5



FESTA

ŠPICA ZA BETON

CrV	Broj	specifikacija	
	19408	250 mm	5
	19409	350 mm	5



FESTA

SJEKAČ ZA BETON

CrV	Broj	specifikacija	šifra hrotu	
	19460	300 mm	25 mm	5
	19470	400 mm	30 mm	5



ŠPICA ZA BETON

Broj	specifikacija	
19400	250 mm	5
19403	350 mm	6



SJEKAČ ZA BETON

Broj	specifikacija	šifra hrotu	
19401	250 mm	19 mm	6
19404	350 mm	22 mm	6



SJEKAČ ZA BETON

Broj	specifikacija	šifra hrotu	
19402	250 mm	50 mm	2
19405	350 mm	50 mm	6





NEW

FESTA

LOPATICA,
ROST FREI

INOX

Broj	specifikacija
31519	75 mm



10

LOPATICA,
ROST FREI

INOX

Broj	specifikacija
31497	63 x 195 mm



12



FESTA

TAPETARSKI NOŽ,
ROST FREI

INOX

Broj	specifikacija
31503	150 mm



12



ZIDNA STRUGALICA

MADE IN
EU

Broj	specifikacija
31501	100 mm
31502	marginia de rezervă



30

1

LOPATICA
ZA GIPSANE PLOČE, PVC

PLASTIC

Broj	specifikacija
34308	50 mm
34307	80 mm
34306	100 mm
34305	150 mm



20

12

10

12



DRŽAČ BRUSNE MREŽICE

Broj	specifikacija
34301	230 x 105 mm
34304	235 x 80 mm



1

1



FESTA

DRŽAČ BRUSNE MREŽICE

Broj	specifikacija
34200	210 x 115 mm
34201	240 x 105 mm
34202	240 x 80 mm



30

50

50



DRŽAČ BRUSNE MREŽICE

držalo 52030

ALU

Broj	specifikacija
34203	230 x 80 mm aluminium
52030	teleskop štap



1

12

BRUSNA
MREŽICA,
10 KOM.

10x

Broj	specifikacija
34271	115 x 290 mm oštrina 120
34272	115 x 290 mm oštrina 100
34273	115 x 290 mm oštrina 80
34274	93 x 290 mm oštrina 120
34275	93 x 290 mm oštrina 100
34276	93 x 290 mm oštrina 80



80

80

80

80

80

80

80

BRUSNA
MREŽICA,
10 KOM.

3x

Broj	specifikacija
34280	115 x 290 mm oštrina 120
34281	115 x 290 mm oštrina 100
34282	115 x 290 mm oštrina 80
34283	93 x 290 mm oštrina 120
34284	93 x 290 mm oštrina 100
34285	93 x 290 mm oštrina 80



20

20

20

20

20

20

20

FESTA

JAPANSKA LOPATICA

4x

Broj	specifikacija	
31452	rost frei	50, 80, 100, 120 mm
31453	metal	50, 80, 100, 120 mm



FESTA

JAPANSKA LOPATICA, PLASTIKA

4x

Broj	specifikacija	
31454	50, 80, 100, 120 mm	12



ČELIČNA LOPATICA

Broj	specifikacija	
31601	180 mm - ravna	1
31602	180mm A1	1
31603	180mm A2	1
31641	180 mm - e4	1

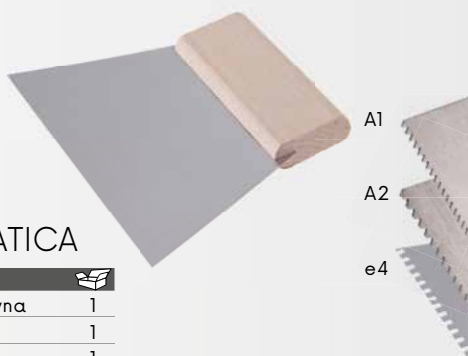

LOPATICA

Broj	specifikacija	
31651	250 mm - ravna	1
31655	250 mm - e4	1

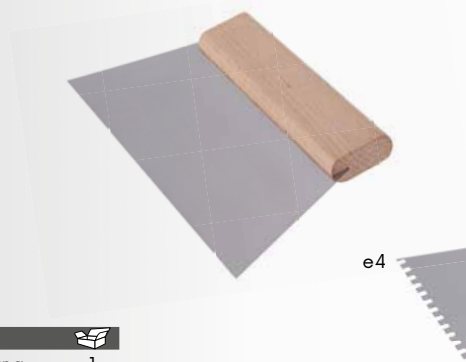

GLADIJICA PLASTIČNA

Broj	specifikacija	
37101	125 x 85 mm	100
37111	170 x 115 mm	100



GLADIJICA PLASTIČNA

Broj	specifikacija	
37051	ravna	1
37031	zub - 4 x 6 mm	1
37041	zub - 6 x 6 mm	1



ŽLICA ZA FUGE

Broj	specifikacija	
32022	140 x 80 mm	12
32023	125 x 40 mm	12



ŽLICA ZA FUGE JEDNOSTRANA

Broj	specifikacija	
32040	10 mm	20
32041	12 mm	20
32042	15 mm	20
32043	18 mm	20
32044	20 mm	20



ŽLICA ZA FUGE OBOSTRANA

Broj	specifikacija	
32050	10 12 mm	50
32051	10 15 mm	50
32052	10 18 mm	50
32053	15 20 mm	50



FESTASTRUGALICA
ZA YTONG

topola



Broj 32317 specifikacija 450 x 95 mm

MOQ
2**FESTA**STRUGALICA
ZA YTONG
FINI ZUB

topola



Broj 32312 specifikacija 450 x 95 mm

MOQ
2**FESTA**STRUGALICA
ZA YTONG

topola



Broj 32337 specifikacija 260 x 95 mm

MOQ
2**FESTA**STRUGALICA
ZA YTONG
FINI ZUB

topola



Broj 32338 specifikacija 260 x 95 mm

MOQ
2**FESTA**STRUGALICA
ZA YTONG

topola



Broj 32327 specifikacija 230 x 145 mm

MOQ
2STRUGALICA
ZA YTONGMADE IN
EU

Broj 32332 specifikacija 450 x 95 mm

MOQ
2STRUGALICA
ZA YTONGMADE IN
EU

Broj 32333 specifikacija 230 x 145 mm

MOQ
2**FESTA**STRUGALICA
ZA STARU
ŽBUKUMADE IN
EU

Broj 32314 specifikacija 400 x 180 mm

MOQ
2**FESTA**STRUGALICA
ZA STARU
ŽBUKUMADE IN
EU

Broj 32329 specifikacija 270 x 130 mm

MOQ
2STRUGALICA
ZA STARU
ŽBUKUMADE IN
EU

Broj 33168 specifikacija 380 x 160 mm

MOQ
2**FESTA**STRUGALICA
ZA STARU
ŽBUKU

Broj 32320 specifikacija 400 x 180 mm

MOQ
2

STRUGALICA
ZA STARU
ŽBUKU



MOQ
2

Broj	specifikacija	
32311	400 x 180 mm	2

FESTA

PLASTIČNA
BRUSNA
GLADILICA



MOQ
2

Broj	specifikacija	
32324	270 x 130 mm P 16	2
32323	270 x 130 mm P 16 brusni papir	10

FESTA

BRUSNA
GLADILICA



MOQ
2

Broj	specifikacija	
32318	400 x 180 mm	2
32319	500 x 250 mm	2
32321	400 x 180 mm P 16 brusni papir	10
32322	500 x 250 mm P 16 brusni papir	10

FESTA

PLASTIČNA
BRUSNA
GLADILICA



MOQ
2

Broj	specifikacija	
32330	400 x 180 mm	2
32331	270 x 130 mm	2

STRUGALICA ZA
KAMENU VUNU

Zn

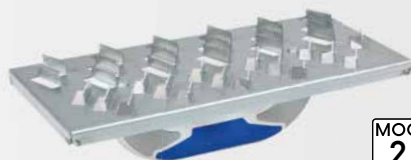

MOQ
2

Broj	specifikacija	
32328	285 x 145 mm	10

FESTA

STRUGALICA



MOQ
2

Broj	specifikacija	
32325	225 x 105 mm	2

STRUGALICA

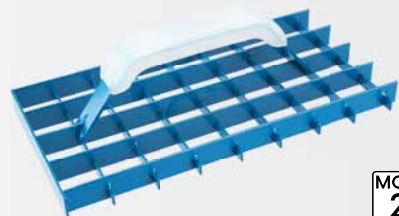

MOQ
2

Broj	specifikacija	
32316	280 x 150 mm	20

STRUGALICA
MREŽASTA
NAZUBILJENA

Broj	specifikacija	
32335	290 x 145 mm	2

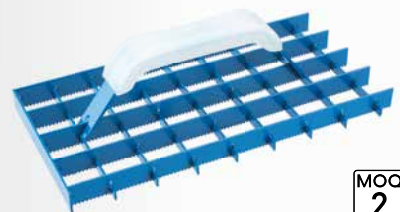

MOQ
2

STRUGALICA

8 britvi

ALU

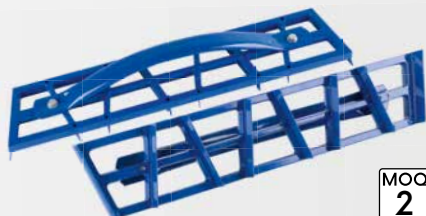

MOQ
2

Broj	specifikacija	
32326	450 x 90 mm	20

STRUGALICA
PLASTIČNA

6 britvi

Broj	specifikacija	
32315	270 x 90 mm	30



MOQ
2

FESTA

GLADILICA
PLASTIČNA



MOQ
20

Broj	specifikacija	
34027	400 x 180 mm	20

GLADILICA
PLASTIČNA



MOQ
20

Broj	specifikacija	
34028	400 x 180 mm	20

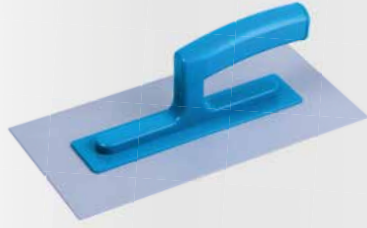
FESTAGLADIČICA
PLASTIČNA
ABSMADE IN
EU

Broj	specifikacija	
34041	280 x 140 - 2 mm	10
34051	280 x 140 - 3 mm	10
34053	280 x 140 - 3 mm zubi - e6	10

FESTAGLADIČICA
PLASTIČNA

Č.p.	specifikace	
30003	270 x 125 mm	28
30004	235 x 115 mm	35
30005	210 x 115 mm	38
30007	210 x 60 mm	44

FESTAGLADIČICA
DRVENA

lipovo drvo



Broj	specifikacija	
34005	400 x 145 mm	40
34007	290 x 145 mm	20

GLADIČICA
DRVENA

topolovo drvo



Broj	specifikacija	
34006	400 x 145 mm	40

GLADIČICA
PURMADE IN
EU

Broj	specifikacija		Broj	specifikacija	
34122	120 x 240 mm	50	34154	220 x 420 mm	15
34132	140 x 280 mm	40	34155	240 x 480 mm	15
34142	180 x 320 mm	25	34156	280 x 500 mm	10
34152	200 x 360 mm	20	34157	330 x 330 mm	5
34121	80 x 260 mm zakošena	50	34158	120 x 800 mm	5
34153	100 x 400 mm	30	34159	120 x 1000 mm	5
			34160	120 x 1200 mm	5

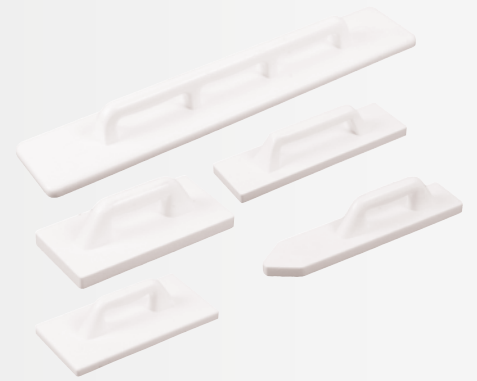
GLADIČICA
POLYSTYRENMADE IN
EU

Broj	specifikacija	
34101	80 x 350 mm zakošena	10
34061	130 x 270 mm	10
34111	170 x 320 mm	10
34071	130 x 450 mm	10
34081	140 x 750 mm	10
34091	140 x 900 mm	5

GLADIČICA PUR



Broj	specifikacija	
34115	140 x 280 mm	36
34116	180 x 320 mm	36
34117	200 x 360 mm	24

IZRAVNAVAJUĆA
PLOČAMADE IN
EU

Broj	specifikacija	
15889	980 x 380 mm držalo Ø 32 mm	1

Ø 23 mm



POBIRAČ VODE

Broj	specifikacija	
15886	450 mm držalo Ø 23 mm	48
15887	600 mm držalo Ø 23 mm	48
15888	750 mm držalo Ø 23 mm	32

Ø 32 mm

IZRAVNAVAJUĆA
LETVAMADE IN
EU

Broj	specifikacija	
15885	100 x 800 mm držalo Ø 32 mm	1

MATERIJAL PREDNJA STRANA	BETON		ŽBUKA				LJEPILA I MASE ZA FUGIRANJE	LJEPILO ZA FASADE	PRIMJENA
	GRUBO	FINO	TVRDA	MEKANA	MEKANA ZA YTONG	MEKANA FASADNA			
CRNI FILC (SMEĐI, SIVI)				••••		••			Za fino zaribavanje žbuke, koristi se za veće granulacije žbuke.
BIJELI FILC				••••	••••	••••			Za fino zaribavanje žbuke, koristi se za manje granulacije žbuke.
FINI MOLITAN				••••	••••	••••			Za eliminaciju pijeska na površini, za zaglađivanje finih materijala.
GRUBI MOLITAN				••••	••••	••••			Za eliminaciju pijeska na površini, za zaglađivanje grubih materijala.
RASTER MOLITAN				••••	••••	••••			Za eliminaciju pijeska, zahvaljujući rasteru pruža mogućnost boljeg zaglađivanja grubih materijala.
MORSKA SPUŽVA					•••		••••		Ispiranje spojnih materijala, za debele spojeve (fuge), eliminacija pijeska u spoju.
HYDRO SPUŽVA FINA, GRUBA					•		••••		Ispiranje spojnih materijala, za debele spojeve (fuge), eliminacija pijeska u spoju.
SPUŽVA				••	••••	••	••••		Ispiranje spojnih materijala, zaglađivanje mekih žbuka.
MIKROGUMA							••••		Za fugiranje.
GUMENA PJENA							••••		Za fugiranje.
MIRELON		••••	•••						Obrada betona, izvlačenje i fino zaribavanje.
DUREN				••••	••	••••			Za zaribavanje spojeva svježih žbuka.
DRVO	••••	••••	••••						Obrada betona, izvlačenje i fino zaribavanje.
ČELIČNI LIM	••	••••		••		••••	••		Zaglađivanje betona
STIROPOR	•••	••••	•••	••		••			Obrada betona, izvlačenje i fino zaribavanje.
POLYURETHAN	••••	••••	••••						Obrada betona, izvlačenje i fino zaribavanje.
ABS		••		••••	••••	••••		••••	Navlačenje sepa na fasadu, razvlačenje fine mekane žbuke.
GLADILICA ROST FREI RAVNA				••••	••••	••••		••••	Razvlačenje fine mekane žbuke, nanošenje ljepila za stiropor na fasadu.
GLADILICA ROST FREI NAZUBLJENA							••••		Nanošenje ljepila za elemente pročelja i podova.
STRUGALICA ZA STIROPOR PLASTIČNA			••					••••	Brušenje polistirena, cementnog ljepila, betona, žbuke i gipsa.
STRUGALICA ZA STIROPOR DRVENA			••					••••	Brušenje fasadnog polistirena.

**FESTA**

GLADIČICA
PLASTIČNA
SA BIJELIM PLIŠOM



Č.p.	specifikace	
34400	280 x 140 x 8 mm	15
34415	250 x 130 x 8 mm	15
34450	220 x 130 x 8 mm	15
34445	220 x 70 x 8 mm	20

**FESTA**

GLADIČICA
PLASTIČNA
SA CRNIM FILCOM



Č.p.	specifikace	
34401	280 x 140 x 10 mm	15
34416	250 x 130 x 10 mm	15
34451	220 x 130 x 10 mm	15
34446	220 x 70 x 10 mm	20

**FESTA**

GLADIČICA
PLASTIČNA
FINI MOLITAN



Č.p.	specifikace	
34404	280 x 140 x 30 mm	10
34485	280 x 130 x 20 mm	10
34486	250 x 130 x 30 mm	10
34419	250 x 130 x 20 mm	10
34453	220 x 130 x 20 mm	10
34447	220 x 70 x 20 mm	10

**FESTA**

GLADIČICA
PLASTIČNA
FINA SPUŽVA



Č.p.	specifikace	
34405	280 x 140 x 18 mm	15
34420	250 x 130 x 18 mm	15
34454	220 x 130 x 18 mm	15
34449	220 x 70 x 18 mm	20
34480	280 x 140 x 12 mm	15
34481	250 x 130 x 12 mm	15
34482	220 x 130 x 12 mm	15

**FESTA**

GLADIČICA PLASTIČNA
EXTRA FINA
SPUŽVA



Broj	specifikacija	
34443	280 x 140 x 12 mm	15
34442	250 x 130 x 12 mm	15

**FESTA**

GLADIČICA
PLASTIČNA
GRUBA SPUŽVA



Broj	specifikacija	
34441	280 x 140 x 12 mm	15
34440	250 x 130 x 12 mm	15
34439	250 x 130 x 18 mm	15



FESTA

GLADIČICA PLASTIČNA
SA RASTER
MOLITANOM



Broj	specifikacija	
34409	280 x 140 x 30 mm	10
34425	250 x 130 x 20 mm	10

FESTA

GLADIČICA
PLASTIČNA
GRUBI MOLITAN



Broj	specifikacija	
34410	280 x 140 x 30 mm	10
34426	250 x 130 x 20 mm	10

FESTA

GLADIČICA PLASTIČNA
MORSKA SPUŽVA



Č.p.	specifikace	
34406	280 x 140 x 30 mm	10
34421	250 x 130 x 30 mm	10
34455	220 x 130 x 30 mm	10

FESTA

GLADIČICA PLASTIČNA
MORSKA SPUŽVA,
RASTER



Č.p.	specifikace	
34413	280 x 140 x 30 mm	10
34428	250 x 130 x 30 mm	10

FESTA

GLADIČICA PLASTIČNA
SA SPUŽVOM



Č.p.	specifikace	
34412	280 x 140 x 30 mm	10
34424	250 x 130 x 30 mm	10
34458	220 x 130 x 30 mm	10

FESTA

GLADIČICA PLASTIČNA
SA SPUŽVOM
RASTER



Č.p.	specifikace	
34490	280 x 140 x 30 mm	10
34491	250 x 130 x 30 mm	10

FESTA

GLADIČICA PLASTIČNA
SA SPUŽVOM



Č.p.	specifikace	
34411	280 x 140 x 30 mm	10
34423	250 x 130 x 30 mm	10
34457	220 x 130 x 30 mm	10

FESTA

GLADIČICA PLASTIČNA
SA GUMENOM
PJENOM



Č.p.	specifikace	
34402	280 x 140 x 10 mm	15
34417	250 x 130 x 10 mm	15
34452	220 x 130 x 10 mm	15

FESTA

GLADIČICA PLASTIČNA
SA MIKROGUMOM



Č.p.	specifikace	
34403	280 x 140 x 8 mm	15
34418	250 x 130 x 8 mm	15
34496	220 x 130 x 8 mm	15

FESTA

GLADIČICA PLASTIČNA
DUREN



Č.p.	specifikace	
34407	280 x 140 x 20 mm	10
34422	250 x 130 x 20 mm	10
34456	220 x 130 x 20 mm	10
34448	220 x 70 x 20 mm	10

FESTA

GLADIČICA
PLASTIČNA-
RUVEN



Č.p.	specifikace	
34414	280 x 140 x 20 mm	10
34429	250 x 130 x 20 mm	10

FESTA

GLADIČICA
PLASTIČNA



Č.p.	specifikace	
30003	270 x 125 mm	28
30004	235 x 115 mm	35
30005	210 x 115 mm	38
30007	210 x 60 mm	44

FESTAGLADIJICA
PLASTIČNA
SA GUMOMMADE IN
EU

Č.p.	specifikace	
34033	240 x 95 mm	5

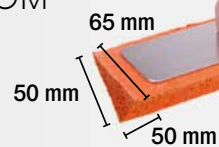
GLADIJICA
SA SPUŽVOM
90°

Č.p.	specifikace	
34500	350 mm	6

REZERVNI
FILCMADE IN
EU

Č.p.	specifikace	
34241	280 x 140 x 8 mm	1
34223	250 x 130 x 8 mm	1

REZERVNI
FILCMADE IN
EU

Č.p.	specifikace	
34243	280 x 140 x 10 mm	1
34221	250 x 130 x 10 mm	1

REZERVNA
FINA SPUŽVAMADE IN
EU

Č.p.	specifikace	
34262	280 x 140 x 18 mm	1

REZERVNI
FINI MOLITANMADE IN
EU

Č.p.	specifikace	
34251	280 x 140 x 30 mm	1

REZERVNI
MOLITAN
GRUBIMADE IN
EU

Broj	specifikacija	
34261	280 x 140 x 30 mm	1

REZERVNA
MORSKA
SPUŽVAMADE IN
EU

Broj	specifikacija	
34265	280 x 140 x 30 mm	1

REZERVNA
SPUŽVAMADE IN
EU

Broj	specifikacija	
34238	280 x 140 x 30 mm	1

REZERVNA
SPUŽVAMADE IN
EU

Broj	specifikacija	
34237	280 x 140 x 30 mm	1
34235	250 x 130 x 30 mm	1

REZERVNA
GUMENA
PJENAMADE IN
EU

Broj	specifikacija	
34231	280 x 140 x 10 mm	1



FESTA

ELEKTRICNA MIJEŠALICA ZA PRAŠKASTI MATERIJAL

Ulazni	1800 W
Napon / frekvencija	230 V / 50 Hz
Zupčanici	2
1. brzina (brzina u praznom hodu)	0 - 450 ot./min.
2. brzina (brzina u praznom hodu)	0 - 790 ot./min.
Zaštita od preopterećenja	Da
Promjer miješalica	100 mm
Dužina miješalica	570 mm
Težina	5,6 kg



Broj	specifikacija	
35311	miješalica	1
35318	rezervne četkice	1
35319	rezervne miješalice - par (L+R)	1



FESTA

ELEKTRICNA MJEŠALICA 1600W

Ulazna snaga	1600 W
Napon/frekvence	230 V / 50 Hz
Stupanj brzina	2
1. stupanj (brzina bez opterećenja)	0 - 480 ot./min.
2. stupanj (brzina bez opterećenja)	0 - 800 ot./min.
Zaštita	Da
Navoj	M 14
Mješač	140 mm
Dužina mješalice	600 mm
Težina	4,7 kg

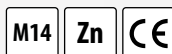

Broj	specifikacija	
35310		1
35317	rezervne četkice	1



FESTA

ELEKTRICNA MJEŠALICA 850W

Ulazna snaga	850 W
Napon/frekvence	230 V / 50 Hz
Stupanj brzina	1
1. stupanj (brzina bez opterećenja)	0 - 500 ot./min.
2. stupanj (brzina bez opterećenja)	-
Zaštita	Da
Navoj	M 14
Mješač	120 mm
Dužina mješalice	600 mm
Težina	3,7 kg

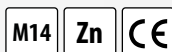

Broj	specifikacija	
35300		1
35316	rezervne četkice	1



**WEST
BERG****ELEKTRIČNA MJEŠALICA 1600W**

Ulazna snaga	1600 W
Napon/frekvence	230 V / 50 Hz
Stupanj brzina	2
1. stupanj (brzina bez opterećenja)	180 - 400 ot./min.
2. stupanj (brzina bez opterećenja)	300 - 700 ot./min.
Zaštita	Da
Navoj	M 14
Mješač	140 mm
Dužina mješalice	600 mm
Težina	5,4 kg

M14 Zn CE

Broj	specifikacija	
35305		1
35315	rezervne četkice	1

**NEW****FESTA****NASTAVAK
MIJEŠALICE****M14**

Broj	specifikacija	
35142	M14	1

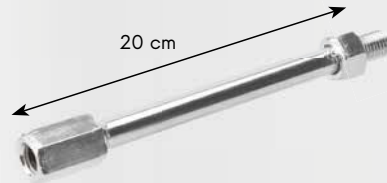

20 cm

**NEW****FESTA****MJEŠALICA**

Spiralna mješalica sa tri oštrice i prstenom – desna – za žitke mase korištene u više slojeva. Miješani material je pritisnut. Žitka masa ne prska iz posude, pigmenti u boji se ravnomjerno i dobro izmješaju.

Zn	M14	Broj	specifikacija		
		35085	M14 Ø 120 x 600 mm	12	
		35086	M14 Ø 140 x 600 mm	12	
		35087	M14 Ø 160 x 600 mm	12	

**FESTA****MJEŠALICA**

Spiralna mješalica sa tri oštrice i prstenom – lijeva – za teške materijale sa visokom viskoznošću (gustoćom), mortove, beton, cement i žbuke, spojne materijale, epokomidne spojeve, bitumenska ljepila.

Zn	M14	Broj	specifikacija		
		35091	M14 Ø 120 x 600 mm	12	
		35092	M14 Ø 140 x 600 mm	12	
		35093	M14 Ø 160 x 600 mm	12	

**FESTA****MJEŠALICA**

Spiralna mješalica sa dvije oštrice – za potpuno miješanje ljepila za pločice, spojnih materijala, grubih materijala, estriha, završnih materijala i glatkih smjesa.

Zn	Broj	specifikacija	
	35038	Ø 80 x 500 mm	24
	35058	Ø 100 x 500 mm	24
	35023	Ø 120 x 500 mm	24



FESTA

MJEŠALICA

Spiralna mješalica sa dvije oštrice - za potpuno miješanje ljepila za pločice, spojnih materijala, grubih materijala, estriha, završnih materijala i glatkih smjesa.

SDS+	Zn	Broj	specifikacija	
		35094	Ø 80 x 500 mm	24
		35095	Ø 100 x 500 mm	24
		35096	Ø 120 x 500 mm	24



FESTA

MJEŠALICA

Spiralna mješalica sa dvije oštrice - za potpuno miješanje ljepila za pločice, spojnih materijala, grubih materijala, estriha, završnih materijala i glatkih smjesa.



M14	Zn	Broj	specifikacija	
		35059	M14 Ø 90 x 550 mm	24



FESTA

MJEŠALICA SPIRALNA

Spiralna mješalica - za potpuno miješanje ljepila za pločice, spojnih materijala, grubih materijala, estriha, završnih materijala i glatkih smjesa.

	Zn	Broj	specifikacija	
		35013	Ø 80 x 500 mm	24
		35006	Ø 100 x 500 mm	24
		35007	Ø 120 x 500 mm	24

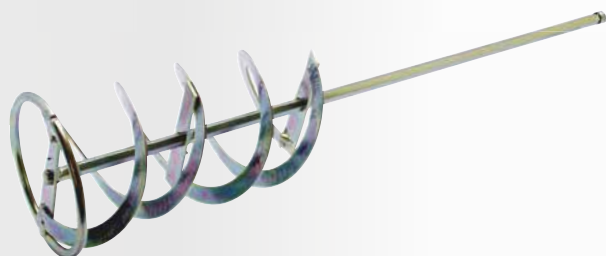

FESTA

MJEŠALICA SPIRALNA

Spiralna mješalica - za potpuno miješanje ljepila za pločice, spojnih materijala, grubih materijala, estriha, završnih materijala i glatkih smjesa.



SDS+	Zn	Broj	specifikacija		
		35012	Ø 100 x 500 mm	24	



FESTA

MJEŠALICA SPIRALNA ŽIČANA

Spiralna mješalica sa dvije oštrice - za potpuno miješanje ljepila za pločice, spojnih materijala, grubih materijala, estriha, završnih materijala i glatkih smjesa.

	Zn	Broj	specifikacija	
		35069	Ø 60 x 500 mm	50
		35078	Ø 80 x 500 mm	24
		35081	Ø 100 x 500 mm	24



FESTA

MJEŠALICA SPIRALNA

Spiralna mješalica sa dvije oštrice - za potpuno miješanje ljepila za pločice, spojnih materijala, grubih materijala, estriha, završnih materijala i glatkih smjesa.

SDS+	Zn	Broj	specifikacija	
		35070	Ø 60 x 500 mm	50
		35079	Ø 80 x 500 mm	24
		35082	Ø 100 x 500 mm	24



FESTA**MJEŠALICA SPIRALNA**

Spiralna mješalica sa dvije oštrice - za potpuno miješanje ljepila za pločice, spojnih materijala, grubih materijala, estriha, završnih materijala i glatkih smjesa.

Zn	Broj	specifikacija	24
	35048	Ø 70 x 500 mm	
	35068	Ø 90 x 500 mm	24

**FESTA****MJEŠALICA SPIRALNA**

Spiralna mješalica - za potpuno miješanje ljepila za pločice, spojnih materijala, grubih materijala, estriha, završnih materijala i glatkih smjesa.

Zn	Broj	specifikacija	24
	35021	Ø 90 x 500 mm	

**FESTA****MJEŠALICA**

Segmentna mješalica - za materijale gdje je prisutnost zraka nepoželjna. Za fine tekuće materijale, prekrivne materijale, materijale za brtvljenje i ljepljenje.

Zn	Broj	specifikacija	20
	35015	Ø 100 x 500 mm	

**FESTA****MJEŠALICA**

Mješalica sa propelerom - za tekuće materijale, boje, ljepila za tapete, ljepila za pločice.

Zn	Broj	specifikacija	50
	35011	Ø 80 x 500 mm	

**SPIRALNA MJEŠALICA POCINČANA**

Arkadna mješalica sa prstenom - za potpuno miješanje zidnih boja, disperzivnih boja, ljepila, ljepila za podove, boja, bitumenskih, asfaltnih i ostalih premaza.

Zn	Broj	specifikacija	40	
	35125	Ø 60 x 400 mm		40
	35126	Ø 80 x 400 mm		40
	35127	Ø 100 x 600 mm		20

**MJEŠALICA LAKIRANA**

Arkadna mješalica sa prstenom - za potpuno miješanje zidnih boja, disperzivnih boja, ljepila, ljepila za podove, boja, bitumenskih, asfaltnih i ostalih premaza.

Zn	Broj	specifikacija	40	
	35103	Ø 60 x 400 mm		40
	35113	Ø 80 x 400 mm		40
	35123	Ø 100 x 600 mm		20



FESTA



PROFESIONALNE GRAĐEVINSKE MJEŠALICE

Lescha

Građevinske mješalice za profesionalnu uporabu
 Zupčanik od lijevanog željeza
 Prilagodljiv zupčanik
 Visokokvalitetna završna obrada
 Dvostruki ležaj na dnu bubnja
 Patentirana kvalitetna izolacija prema DIN EN ISO 900
 Specijalno dizajnirani oblik bubnja
 Zaštita protiv pljuskanja vode IP-45
 Izvedba za 230V i 400V

**Lescha**

GRAĐEVINSKA MJEŠALICA



Broj	specifikacija	
35500	Star 150 - 125 l, 230 V nožna kočnica	1

**Lescha**

GRAĐEVINSKA MJEŠALICA



Broj	specifikacija	
35502	EUROMIX 125 l, 230 V	1
35503	EUROMIX 125 l, 400 V	1

**Lescha**

GRAĐEVINSKA MJEŠALICA



Broj	specifikacija	
35501	BX 135 - 125 l, 230 V	1

**Lescha**

GRAĐEVINSKA MJEŠALICA



Broj	specifikacija	
35504	ABM 135 l, 230 V nožna kočnica	1

**Lescha**

GRAĐEVINSKA MJEŠALICA



Broj	specifikacija	
35505	SM 145 S - 140 l, 230 V	1
35506	SM 145 S - 140 l, 400 V	1
35507	SM 145 S - 140 l, 230 V nožna kočnica	1
35508	SM 145 S - 140 l, 400 V nožna kočnica	1

**Lescha**

GRAĐEVINSKA MJEŠALICA



Broj	specifikacija	
35510	SM 165 S - 160 l, 230 V nožna kočnica	1
35511	SM 165 S - 160 l, 400 V nožna kočnica	1
35512	SM 165 S - 160 l, G benzinska	1

**Lescha**

GRAĐEVINSKA MJEŠALICA



Broj	specifikacija	
35514	SM 185 S - 180 l, 230 V nožna kočnica	1
35515	SM 185 S - 180 l, 400 V nožna kočnica	1

**Lescha**

GRAĐEVINSKA MJEŠALICA



Broj	specifikacija	
35516	S 180 HR - 180 l, 230 V nožna kočnica	1
35517	S 180 HR - 180 l, 400 V nožna kočnica	1



Lescha

GRAĐEVINSKA MJEŠALICA



Broj	specifikacija	
35524	LB 354 230 V, 1,5 kW	1
35525	LB 354 400 V, 1,5 kW	1
35527	LB 354 Honda G200	1
35532	LB 404 230 V, 1,5 kW	1
35533	LB 404 400 V, 1,5 kW	1
35539	LB 484 Robin EH17B	1
35540	LB 484 Honda GX160LX	1
35542	AT 480 400 V, 1,2 kW	1

Lescha

GRAĐEVINSKA MJEŠALICA



Broj	specifikacija	
35518	S 230 HR - 230 l, 230 V nožna kočnica	1
35519	S 230 HR - 230 l, 400 V nožna kočnica	1

Lescha

GRAĐEVINSKA MJEŠALICA



Broj	specifikacija	
35552	LHB 1000 400 V	1
35553	LHB 1000 HATZ Diesel	1
35555	LHB 1200 400 V	1



GRAĐEVINSKA MJEŠALICA



Broj	specifikacija	
37500	MIX 130Zk 230 V nesastavljen	1
37501	MIX 130Z 230 V sklopljen	1
37505	MK 165Bk 230 V nesastavljen	1
37506	MK 165B 230 V sklopljen	1

130 L

specifikacija	
volumen bubnja	130 l
broj okretaja bubnja	26±Min ⁻¹
ulazna snaga	700 W
napon	230 V / 50 Hz
stupanj zaštite	IP44
materijal vijenca	lijevano željezo
dimenzije	dužina 1170 mm
	širina 650 mm
	visinat 1280 mm
težina	53 kg

165 L

specifikacija	
volumen bubnja	165 l
broj okretaja bubnja	23±Min ⁻¹
ulazna snaga	900 W
napon	230 V / 50 Hz
stupanj zaštite	IP44
materijal vijenca	lijevano željezo
dimenzije	dužina 1295 mm
	širina 735 mm
	visinat 1440 mm
težina	70 kg

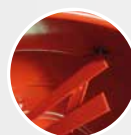

· specijalno izrađene lopatice, debljine 4 mm



· kvalitetni ležaj s poklopcem



· prekidač s sigurnosnom kapom



· plastični poklopac pogona, vijenac od lijevanog željeza

GRAĐEVINSKA MJEŠALICA



125 L

specifikacija	
volumen bubnja	125 l
broj okretaja bubnja	26±Min ⁻¹
ulazna snaga	550 W
napon	230 V / 50 Hz
stupanj zaštite	IP44
materijal vijenca	lijevano željezo
dimenzije	dužina 1102 mm
	širina 690 mm
	visinat 1310 mm
težina	52,5 kg

Broj	specifikacija		
37509	126 l, 230 V	sklopljen	1
37510	126 l, 230 V	nesastavljen	1

162 L

specifikacija	
volumen bubnja	162 l
broj okretaja bubnja	26±Min ⁻¹
ulazna snaga	650 W
napon	230 V / 50 Hz
stupanj zaštite	IP44
materijal vijenca	lijevano željezo
dimenzije	dužina 1180 mm
	širina 710 mm
	visinat 1310 mm
težina	56 kg

Broj	specifikacija		
37515	162 l, 230 V	nesastavljen	1
37516	162 l, 230 V	sklopljen	1

142 L

specifikacija	
volumen bubnja	142 l
broj okretaja bubnja	26±Min ⁻¹
ulazna snaga	650 W
napon	230 V / 50 Hz
stupanj zaštite	IP44
materijal vijenca	lijevano željezo
dimenzije	dužina 1164 mm
	širina 690 mm
	visinat 1293 mm
težina	54 kg

Broj	specifikacija		
37511	142 l, 230 V	nesastavljen	1
37512	142 l, 230 V	sklopljen	1

180 L

specifikacija	
volumen bubnja	180 l
broj okretaja bubnja	26±Min ⁻¹
ulazna snaga	850 W
napon	230 V / 50 Hz
stupanj zaštite	IP44
materijal vijenca	lijevano željezo
dimenzije	dužina 1164 mm
	širina 690 mm
	visinat 1368 mm
težina	58 kg

Broj	specifikacija		
37517	180 l, 230 V	nesastavljen	1
37518	180 l, 230 V	sklopljen	1



GRAĐEVINSKA KOLICA - TAČKE



Broj	specifikacija		
37530	60 l, Ø 38 cm	točak bez napuhavanja	1
37532	60 l, Ø 40 cm	točak za napuhavanje	1



GRAĐEVINSKA KOLICA-POCINČANA



Broj	specifikacija		
37527	80 l, Ø 40 cm	točak za napuhavanje	1
37533	80 l, Ø 38 cm	točak bez napuhavanja	1

TRUP KOLICA
CRNA

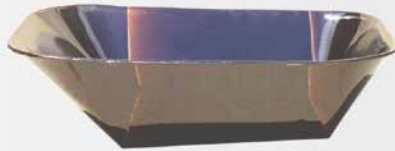

Broj	specifikacija	
37539	60 l	1

TRUP
POCINČANI



Broj	specifikacija	
37541	80 l	1

REZERVNI KOTAČI



Broj	specifikacija	
48729	typ AA 400	točak za napuhavanje 1
48730	typ AA 380	točak bez napuhavanja 1
48731	typ AA 380	točak bez napuhavanja 1

GRAĐEVINSKA
KOLICA



Broj	specifikacija	
37564	60 l	1

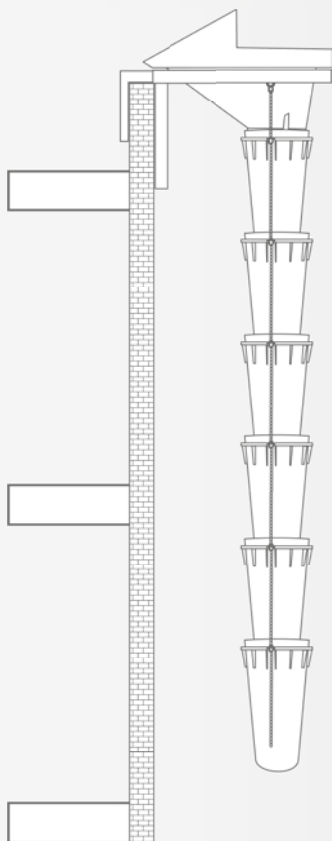

Lescha

CIJEV ZA NASIPAVANJE ŠUTE



Broj	specifikacija	
35603	cijev za građevinski otpad (šutu) promjera 50, dužine 108 cm HDPE	1
35604	ulazna cijev za građevinski otpad HDPE	1
35605	nosivi okvir ulazne cijevi za građevinski otpad	1

HORIZONT®



HORIZONT®

IZRAVNAVAJUĆA LETVA

ALU

Broj	specifikacija	
15310	100 cm	10
15315	150 cm	10
15318	180 cm	10
15320	200 cm	10
15325	250 cm	10
15330	300 cm	10
15335	350 cm	10
15340	400 cm	10



HORIZONT®

IZRAVNAVAJUĆA LETVA, 1 LIBELA

ALU

Broj	specifikacija	
15415	150 cm	10
15418	180 cm	10
15420	200 cm	10
15425	250 cm	10
15430	300 cm	10



HORIZONT®

IZRAVNAVAJUĆA LETVA, 2 LIBELE

ALU

Broj	specifikacija	
15510	100 cm	10
15515	150 cm	10
15518	180 cm	10
15520	200 cm	10
15525	250 cm	10
15530	300 cm	10
15535	350 cm	10
15540	400 cm	5



HORIZONT®

IZRAVNAVAJUĆA LETVA SA RUKOVAHTIMA

ALU

Broj	specifikacija	
15615	150 cm	10
15620	200 cm	10
15625	250 cm	10
15630	300 cm	10



HORIZONT®

IZRAVNAVAJUĆA LETVA, 2 LIB.+ 2 RUK

ALU

Broj	specifikacija	
15710	100 cm	10
15715	150 cm	10
15720	200 cm	10
15725	250 cm	10
15730	300 cm	10
15735	350 cm	10
15740	400 cm	5





HORIZONT
IZRAVNAVAJUĆA LETVA, TRAPEZ PROFIL

TRAPEZOIDNI PROFIL
 · trapezoidni profil služi za finije obrade površine
 · prikladan za štukaturu i fasade
 · prikladan za tanko slojne žbuke

ALU	Broj	specifikacija	
	15810	100 cm	10
	15812	120 cm	10
	15815	150 cm	10
	15818	180 cm	10
	15820	200 cm	10
	15825	250 cm	10
	15830	300 cm	10



HORIZONT
IZRAVNAVAJUĆA LETVA, H PROFIL

PROFIL „h”
 · „h” profil služi za finije obrade površine
 · prikladan za štukaturu i fasade
 · prikladan za štukaturu stropnih žbuka

ALU	Broj	specifikacija	
	15850	100 cm	10
	15853	150 cm	10
	15855	180 cm	10
	15860	200 cm	10
	15870	250 cm	10
	15880	300 cm	10

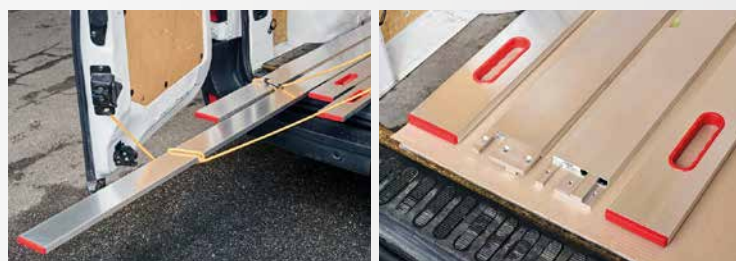

NEW

HORIZONT
SPOJNICA ZA
IZRAVNAVAJUĆE LETVE
HORIZONT

Broj	specifikacija		
15301		1	



HORIZONT
IZRAVNAVAJUĆA LETVA,
1 LIBELA PODESIVA

Broj	specifikacija		
15893	65 - 100 cm	1	
15894	95 - 150 cm	1	
15895	145 - 235 cm	1	



HORIZONT
KUTNIK

ALU	Broj	specifikacija	
	14485	800 x 1200 mm	1
	14486	1000 x 1500 mm	1



**FESTA**

SAVIJAČ ŠIPKE



Broj	specifikacija	
26730	Ø 6 - 14 mm	1
26731	Ø 5 - 8 mm	1

**NEW****FESTA**

DRŽAČ ZA CIGLE



Broj	specifikacija	
60130	27 - 45 cm	10

NEW**FESTA**

DRŽAČ ZA CIGLE



Broj	specifikacija	
60132		1

NEW**FESTA**

KOLICA ZA ROBNIK

· max 150 kg



Broj	specifikacija	
60157		1



SAVIJAČ ŠIPKE

Broj	specifikacija	
26735	max Ø 13 mm 56 cm	1

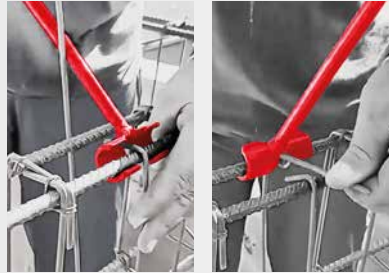
**NEW**

SAVIJAČ ŠIPKE

· Ø 4-8 mm

Broj	specifikacija	
26736		1

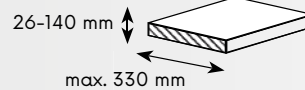
**NEW****FESTA**

REZAČ PLOČICA

· max 45 kg

Broj	specifikacija	
60125		1

**NEW****FESTA**

KOLICA ZA ROBNIK

· max 100 kg



Broj	specifikacija	
60155		1



30 - 50 cm

DRŽAČ ZA CIGLE

Broj	specifikacija	
36310	max. 20kg	5



NOSAČ ZA RUBNI KAMEN

specifikacija	60116
dimenzija čeljusti:	750-1000 mm
max. opterećenje:	120 kg

Broj	specifikacija	
60116	PRO 041	1



NOSAČ ZA RUBNI KAMEN

specifikacija	60115
dimenzija čeljusti:	80-370 mm
max. opterećenje:	50 kg

Broj	specifikacija	
60115	PRO 040	1



NOSAČ ZA RUBNI KAMEN

specifikacija	60117	60118
dimenzija čeljusti:	500-1000 mm	0-500 mm
max. opterećenje:	150 kg	150 kg

Broj	specifikacija	
60117	PRO 042	1
60118	PRO 043	1



ČEKIČ ZA KAMEN

specifikacija	60121	60123
visina	200 mm	200 mm
šířina	70 kg	70 kg
dužina	870 mm	450 mm
težina	2,5 kg	2,2 kg

Broj	specifikacija	
60121	870 mm	1
60123	450 mm	1



GRAĐEVINSKA PODLOŠKA

Broj	specifikacija	
37166	D10 osnovni	25



KOLOTURNIK

Broj	specifikacija	
26780	0,5 t A s kukom	1
26781	0,5 t B s okom	1
26782	0,5 t C s kukom i štitnikom	1
26783	0,5 t D s okom i zaštitom	1

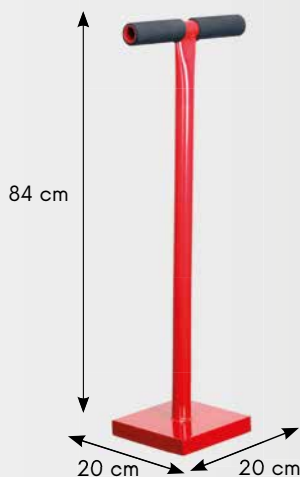

RUČNI NABIJAČ

Broj	specifikacija	
26740	12 kg	1



RUČNA KOLICA - RUDLE

Broj	specifikacija	nosnost	
48719	260 mm bantam	250 kg	1



PROFESIONALNI REZAČ PLOČICA

- Rezačice pločica za najzahtjevnije PROFI korištenje
- Klizanje je riješeno sa devet kugličnih ležajeva SKF, a četiri se daju podešavati
- Amortizirajući stol
- Rezač se može postaviti za rad sa lijevom rukom
- Osigurani rezervni dijelovi i servis
- Rezni kotačići od krom-wolfram čelika

SUPER PRO



REZAČ PLOČICA SUPER PRO "EVO"

• 36195 rezervni kotač za rezanje - Ø 22 mm



Broj specifikacija
36191 1250 mm



1



SUPER PRO



REZAČ PLOČICA SUPER PRO

• 36195 rezervni kotač za rezanje - Ø 22 mm



Broj	specifikacija	
36145	SUPER PRO 450 mm	1
36160	SUPER PRO 600 mm	1
36175	SUPER PRO 750 mm	1
36190	SUPER PRO 900 mm	1



1

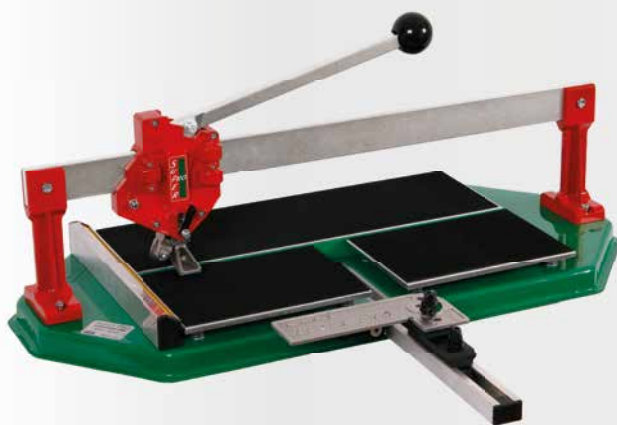

• slika za ilustraciju

REKLAMNI STALAK



Broj	specifikacija	
36200	izložbeni regal	1
36199	izložbeni regal sa rezačima 36160, 36175, 36190	1



FESTA

REZAČ PLOČICA „X“

• 36138 rezervni kotač za rezanje - Ø 22 mm



Broj	specifikacija	
36085	600 mm	1
36087	900 mm	1
36086	1300 mm	1



FESTA

REZAČ PLOČICA

• 36139 rezervni kotač za rezanje - Ø 22 mm



Broj	specifikacija	
36102	1050 mm	1
36103	1300 mm	1
36105	1550 mm	1



FESTA

REZAČ PLOČICA

• 36195 rezervni kotač za rezanje - Ø 22 mm



Broj	specifikacija	
36080	600 mm	1
36081	750 mm	1
36082	900 mm	1
36076	750 mm sklopljen	1
36077	900 mm sklopljen	1



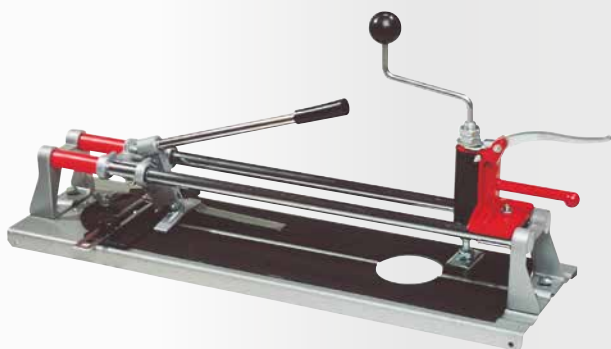

REZAČ PLOČICA

· 36128 rezervni kotač za rezanje - Ø 16 mm



Broj	specifikacija	
36014	480 mm	4

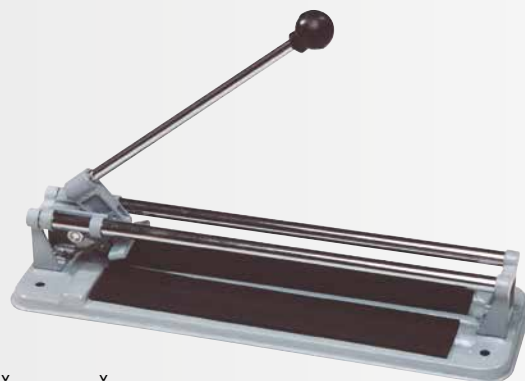

REZAČ PLOČICA

· 36126 rezervni kotač za rezanje - Ø 15 mm



Broj	specifikacija	
36024	300 mm	10
36034	400 mm	10
36035	600 mm	4



REZAČ PLOČICA

· 36136 rezervni kotač za rezanje - Ø 22 mm



Broj	specifikacija	
36036	480 mm	1

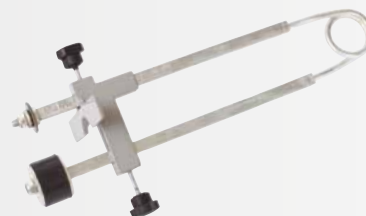

RUČNI REZAČ PLOČICA

· 36136 rezervni kotač za rezanje - Ø 22,2 mm



Broj	specifikacija	
36046	22 mm	1

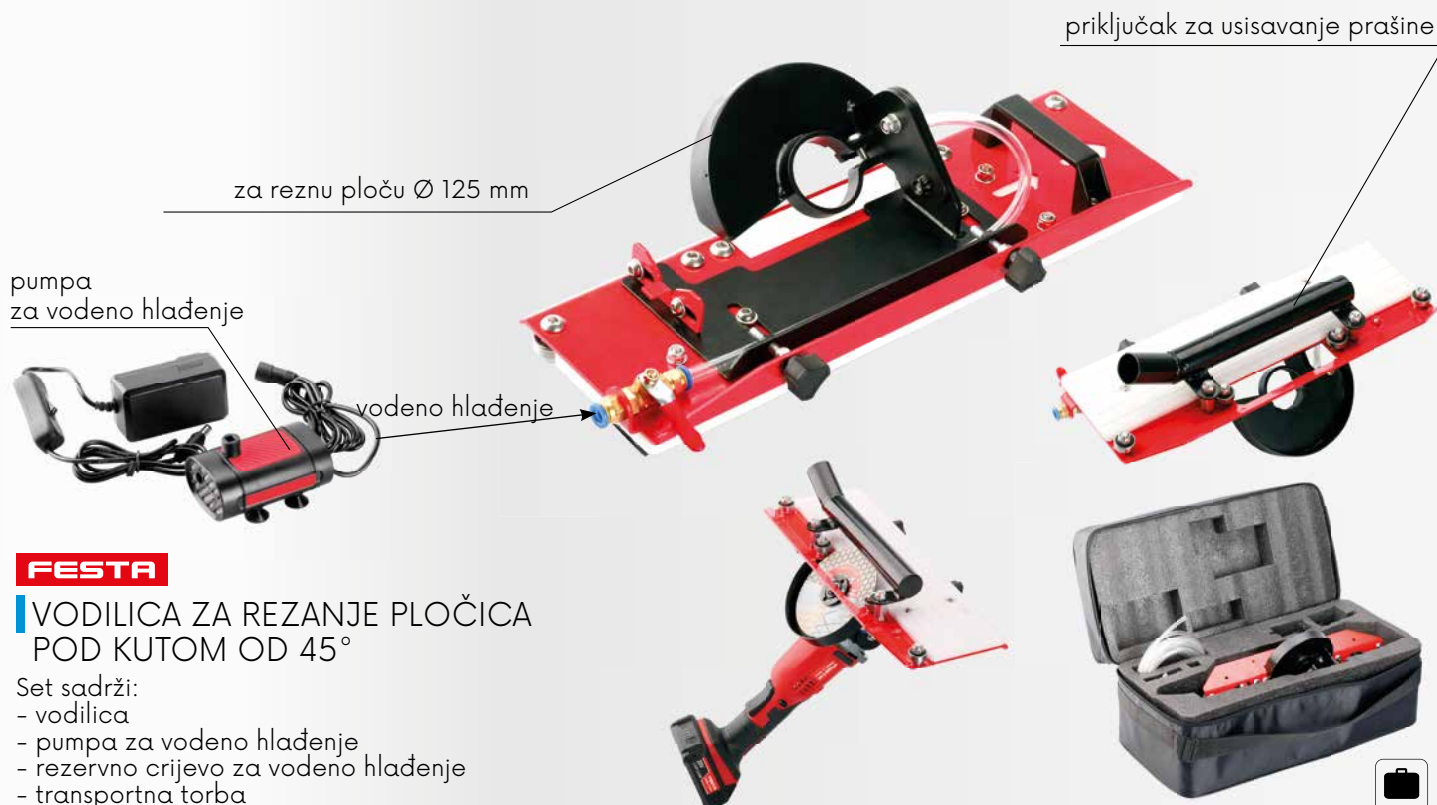

FESTA

VODILICA ZA REZANJE PLOČICA POD KUTOM OD 45°

Set sadrži:

- vodilica
- pumpa za vodeno hlađenje
- rezervno crijevo za vodeno hlađenje
- transportna torba

Broj	specifikacija	
24680		1



REZERVNI REZNI KOTAČIČI



Broj	specifikacija	
36126	a= Ø 15 mm, b= Ø 6 mm, c= 1,5 mm	1
36128	a= Ø 16 mm, b= Ø 6 mm, c= 3 mm	1
36130	a= Ø 20 mm, b= Ø 6 mm, c= 5 mm	1
36136	a= Ø 22 mm, b= Ø 6 mm, c= 2 mm	1
36138	a= Ø 22 mm, b= Ø 6 mm, c= 5 mm	1
36139	a= Ø 22 mm, b= Ø 6 mm, c= 6 mm	1
36195	a= Ø 22 mm, b= Ø 6 mm, c= 4,8 mm	1



KARBIDNI LIST PILE ZA KERAMIKU

Broj	specifikacija	
24055	Karbid - BOSCH, MAKITA	1



FESTA

KLIJEŠTA ZA PLOČICE



Broj	specifikacija	
36057	200 mm	6



KLIJEŠTA ZA PLOČICE



Broj	specifikacija	
36056		10



KLIJEŠTA ZA PLOČICE



Broj	specifikacija	
36059		1



KLIJEŠTA PAPAGAJ



Broj	specifikacija	
36058	200 mm	6



FESTA

REZAČ LAMINATA I VINILA



Broj	specifikacija	
36140	210 mm	4



NEW



FESTA

GLADILICA ZA SILIKON

Broj specifikacija

37050



1

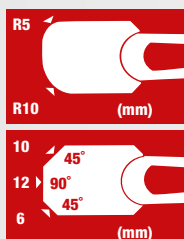

FESTA

GLADILICA ZA SILIKON

Broj specifikacija

16056 145 mm



50

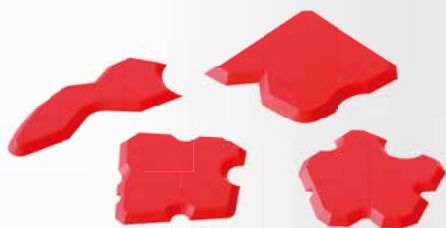

SET GLADILICA ZA SILIKON

4x

Broj specifikacija

37052



1



SET GLADILICA ZA SILIKON

4x

Broj specifikacija

37053



48



GLADILICA ZA SILIKON

Broj specifikacija

37054



1



GLADILICA ZA SILIKON

za brtvljenje prozora

Broj specifikacija

37055



1

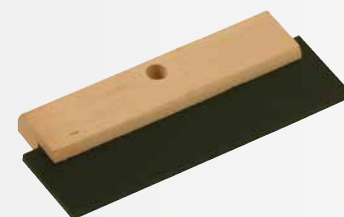

DRVENA GLADILICA SA GUMOM

Broj specifikacija

37011 180 mm



12

37021 280 mm

12



37028



37029



37025



37026

SPUŽVA 160 X 110 X 60 MM

Broj specifikacija

37028

spužva



1

37029

spužvasta kocka

1

SPUŽVA 200 X 100 X 100 MM

Broj specifikacija

37025

mekana molitanska kocka



1

37026

spužvasta kocka

1



KADICA KERAMIČARSKA

Broj specifikacija

37117

komplet



1

90070

kadica 25 l

1

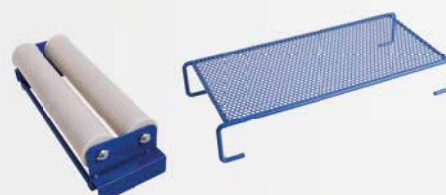

KADICA - PRIBOR

Broj specifikacija

90072

rešetka



1

90071

metalni valjci

1



4 mm

ČISTAČ FUGA



Broj	specifikacija	
37012		1



37006

37007

ČISTAČ FUGA

Broj	specifikacija	
37006	30 mm	20
37007	50 mm	20
37008	rezervni nož 30 mm	50
37009	rezervni nož 50 mm	50



SET ZA PRIMJENU I UKLANJANJE SILIKONA

3x

Broj	specifikacija	
16042		12

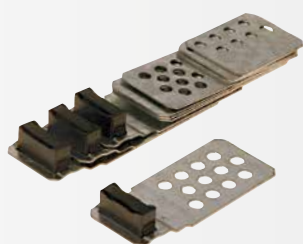

MAGNETI ZA VRATAŠCA



4x



Broj		
38920		1



POMIČNI MAGNETI ZA VRATAŠCA



4x



Broj		
38923		24



GRADITELJSKI KUTOVI

Broj		
38919		50



PIŠTOLJ ZA FUGIRANJE



Broj	specifikacija	
38026	5x nastavka	25



VREĆICA ZA FUGIRANJE



Broj	specifikacija	
38042	3x nastavka	6

NEW

- Ø 10 mm
- Ø 14 mm
- Ø 20 mm
- Ø 10 x 35 mm

FESTA

ALAT ZA FUGIRANJE

Broj	specifikacija	
38045		1



Ø 10 mm



SET ZA MONTAŽU LAMINATA

24x

Broj	specifikacija	količina
52130		1



MONTAŽNI KLINOVI

50x

Broj	specifikacija	količina
37210	95 x 45 x 15 - 0 mm	50
37211	70 x 30 x 8 - 0 mm	50



UNIVERZALNI JASTUČIĆ NA NAPUHAVANJE

- dimenzija 15 x 17 cm
- maksimalna visina 5 cm

Broj	specifikacija	količina
37220		1

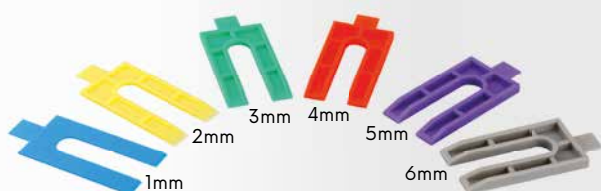

ODSTOJNICI

30x

Broj	specifikacija	količina
37212	1 - 6 mm, 5x bilo koje veličine	1

FESTA MONTAŽNI KLINOVI



Broj	specifikacija	količina
37204	55 x 20 x 0 - 6 mm	20
37203	65 x 18 x 0 - 12 mm	20
37202	80 x 25 x 3 - 10 mm	20
37201	100 x 25 x 1 - 16 mm	14
37200	150 x 25 x 1 - 25 mm	8



FESTA PLASTIČNE KAJLICE

Broj	specifikacija	količina
37155	0 - 8 mm	30
37156	0 - 4 mm	100
37157	2,5 - 8 mm	30



FESTA KAJLICE

250x

Broj	specifikacija	količina
37205	55 x 8 x 0 - 10 mm	250



NIVELYS TEMELJNI PROFIL POD PLOČICAMA

ALU

Broj	specifikacija	količina
37105	50 cm	1
37106	100 cm	1
37107	150 cm	1



NIVELYS
LEVELING SYSTEM
FESTA

PODESIVE NOGE ZA PROFIL TEMELJA

- max. 50 kg

2x

Broj	specifikacija	količina
37102		1

NIVELYS

LEVELING SYSTEMS

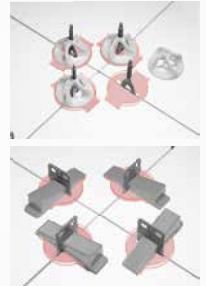

NIVELYS
LEVELING SYSTEMS FESTA

NAVOJNA ODSTOJNA KOPČA

50x

Broj	specifikacija	
37131	1 mm	40
37132	2 mm	40

NIVELYS
LEVELING SYSTEMS FESTA

ŠEŠIR ZA ODSTOJNU KOPČU

50x

Broj	specifikacija	
37130		15

NIVELYS
LEVELING SYSTEMS FESTA

ZAŠTITNE PLOČE ZA SISTAVSKE ZA IZRAVNAVANJE PLOČICA

100x

Broj	specifikacija	
37192		1

NIVELYS
LEVELING SYSTEMS FESTA

ODSTOJNICI ZA PLOČICE

· klinovi 37715, 37176

50x

Broj	specifikacija	kom	
37170	1 mm	50	60
37171	2 mm	50	60
37172	3 mm	50	60

NIVELYS
LEVELING SYSTEMS FESTA

ODSTOJNICI ZA PLOČICE

100x

Broj	specifikacija	kom		Broj	specifikacija	kom	
37185	1 mm	100	1	37187	3 mm	100	1
37190	1,5 mm	100	1	37188	4 mm	100	1
37186	2 mm	100	1	37189	5 mm	100	1

NIVELYS
LEVELING SYSTEMS FESTA

ODSTOJNICI ZA PLOČICE

100x

Broj	Specifikacija	
37162	1,5 mm	1

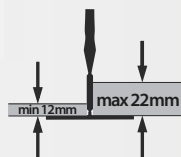

NIVELYS
LEVELING SYSTEMS FESTA

KLINOVI ZA NIVELIRANJE PLOČICA

Broj	kom	
37175	50	40
37176	400	3



NIVELYS
LEVELING SYSTEMS FESTA

NIVELYS
LEVELING SYSTEMS **FESTA**

ODSTOJNICI ZA PLOČICE

600x

Broj	specifikacija	kom	krabice	
37125	1 mm	600	38 x 28 x 19 cm	1
37126	1,5 mm	600	38 x 28 x 19 cm	1
37127	2 mm	600	38 x 28 x 19 cm	1



NIVELYS
LEVELING SYSTEMS **FESTA**

ODSTOJNICI + KLIHOVI ZA NIVELIRANJE PLOČICA

Broj	specifikacija	
37173	1 mm, 400 kom + 200 kom	1
37174	1,5 mm, 400 kom + 200 kom	1



NIVELYS
LEVELING SYSTEMS **FESTA**

KLIJEŠTA ZA KLIHOVE

Broj	
37177	1



NIVELYS
LEVELING SYSTEMS **FESTA**

KLIJEŠTA ZA KLIHOVE

Broj	
37178	1



KLIP ZA IZRAVNAVANJE PLOČICA

50x

Broj	specifikacija	
37199	1,5 mm	40



NIVELYS
LEVELING SYSTEMS **FESTA**

KRIŽIĆI PLASTIČNI

100x

Broj	specifikacija	kom	
37195	1,0 mm	100	12
37196	1,5 mm	100	12
37197	2 mm	100	12
37198	3 mm	100	12



FESTA

KRIŽIĆI PLASTIČNI

Broj	specifikacija	kom	
37148	1,0 mm	200	100
37149	1,5 mm	200	100
37150	2 mm	200	100
37151	2,5 mm	200	100
37152	3 mm	150	100
37153	4 mm	100	100
37154	5 mm	75	100
37158	10 mm	30	100



FESTA

KRIŽIĆI PLASTIČNI

100x

Broj	specifikacija	
37285	1,5 mm	100
37286	2 mm	100
37287	2,5 mm	100
37288	3 mm	100
37289	4 mm	100



NEW

horizontalni položaj
110 kg

Ø 220 mm

vertikalni položaj
80 kg

USB-C



FESTA
POWER X TOOLS

VAKUUMSKA ČAŠICA AKU

Ø 220 mm	80kg	110kg	ROUGH SURFACE	USB-C	Li-ion 3.6V 2Ah
----------	------	-------	---------------	-------	--------------------

No. 36326
specifikacija



FESTA

DRŽAČ ZA PLOČICE
S INDIKATOROM VAKUUMA

Ø 200 mm	140kg	100kg	ROUGH SURFACE
----------	-------	-------	---------------

Broj 36325
specifikacija

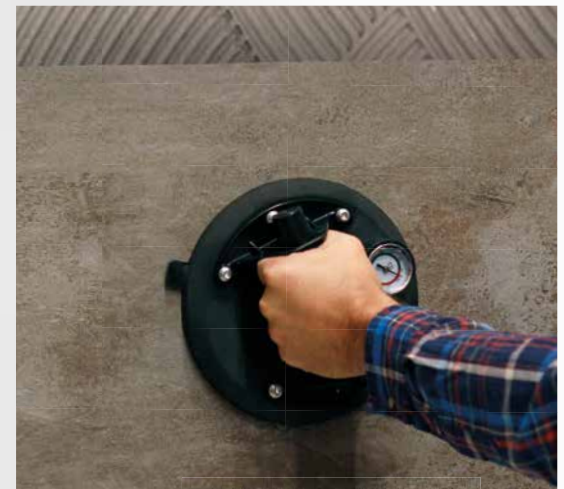

FESTA

DRŽAČ ZA STAKLO

položaj	max. opterećenje
horizontalni položaj	120 kg
vertikalni položaj	150 kg

ALU

Broj 36318
specifikacija triple 10



FESTA

DRŽAČ ZA STAKLO

položaj	max. opterećenje
horizontalni položaj	80 kg
vertikalni položaj	100 kg

ALU

Broj 36313
specifikacija dvostruki 20



FESTA

DRŽAČ ZA STAKLO

položaj	max. opterećenje
horizontalni položaj	50 kg
vertikalni položaj	50 kg

ALU

Broj 36314
specifikacija jednostruki 20



DRŽAČ ZA STAKLO

Broj 36305
specifikacija jednostruki 60



DRŽAČ ZA STAKLO

Broj 36306
specifikacija dvostruki 20



DRŽAČ ZA STAKLO

položaj	max. opterećenje
horizontalni položaj	80 kg
vertikalni položaj	100 kg

Broj 36319
specifikacija triple 10

**FESTA**

OPUCAVAČ 30 M + PUDER 120 G

- 6x brži okretni mehanizam
- može služiti kao visak



Broj
37070

6

**FESTA**

OPUCAVAČ 30 M + PUDER 150 G

- 5x brži okretni mehanizam



Broj
37065

6



OPUCAVAČ ABS 30 M + PUDER 180 G



Broj
37069

10



OPUCAVAČ PLASTIČNI 30 M



Broj
37066

25



OPUCAVAČ 30 M

ALU

Broj
37068

25



OPUCAVAČ ABS 30 M



Broj
37067

25

**FESTA**

PUDER 180 G

Broj	specifikacija	
37096	plava	10
37094	svijetlo plava	10
37097	crvena	10
37095	svijetlo crvena	10
37098	crna	10

**FESTA**

ZIDARSKI KONOP CRVENI



Broj
38895
38896

specifikacija
50 m
100 m

24
24

**FESTA**

ZIDARSKI KONOP ŽUTI



Broj
38899
38900

specifikacija
50 m
100 m

24
24

**FESTA**

ZIDARSKI KONOP 50 M

Broj	specifikacija	
38907	crvena 1,0 mm	100
38908	crvena 1,7 mm	100
38909	crvena 2,0 mm	100



FESTA

ZIDARSKI KONOP
50 M

Broj	specifikacija	
38904	žuti 1,0 mm	100
38905	žuti 1,7 mm	100
38906	žuti 2,0 mm	100



FESTA

ZIDARSKI KONOP
50 M

Broj	specifikacija	
38910	narančasti 1,0 mm	100
38911	narančasti 1,7 mm	100
38912	narančasti 2,0 mm	100



FESTA

ZIDARSKI KONOP
50 M

Broj	specifikacija	
38901	bijeli 1,0 mm	100
38902	bijeli 1,7 mm	100
38903	bijeli 2,0 mm	100



ŠPAGA PREMAZANA VOSKOM



Broj	dužina	Ø	
50920	50 m	1 mm	80



FESTA

VISAK SA KONOPOM 15 M

Broj	specifikacija	
38916	150 g	10
38917	300 g	6
38918	500 g	5



FESTA

VISAK

Broj	specifikacija	
38913	150 g	10
38914	300 g	10
38915	500 g	10

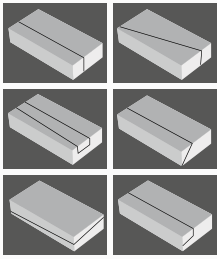

**FESTA****STROJ ZA REZANJE STIROPORA**

- Napon / frekvencija: 230 V/50 Hz
- Potrošnja energije: 200 W
- Duljina reza: 137 cm
- Visina reza: 30 cm
- Zaštita: IP44
- Kut rezanja: 0° - 90°

· oprema: stalak, nožni prekidač, držač, Ni-Cr žica za rezanje, mesingana četka za čišćenje, alati, okovi, plastični luk s kotačićem



Broj Specifikacija

35348

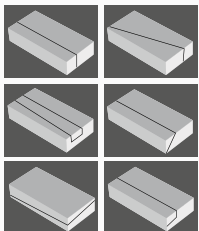

1

**FESTA****STROJ ZA REZANJE STIROPORA**

- Napon / frekvencija: 230 V / 50 Hz
- Potrošnja energije: 200 W
- Duljina reza: 137 cm
- Visina reza: 30 cm
- Zaštita: IP44
- Kut rezanja: 0° - 90°

oprema: Ni-Cr rezna žica, mesing četka za čišćenje, imbus ključ



Broj specifikacija

35345



1

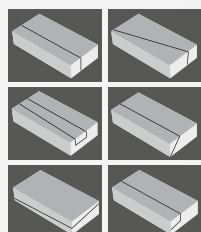

FESTA

STROJ ZA REZANJE STIROPORA

- Napon / frekvencija: 230 V / 50 Hz
- Potrošnja energije: 160 W
- Duljina reza: 117 cm
- Visina reza: 52 cm
- Zaštita: IP44
- Kut rezanja: 0° - 90°



oprema: Ni-Cr rezna žica, mesing četka za čišćenje, imbus ključ

Broj specifikacija
35344



1

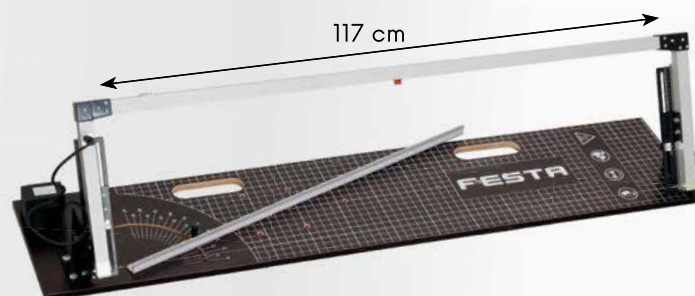
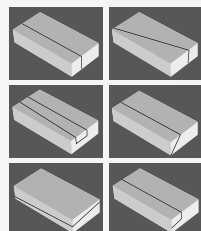

FESTA

STROJ ZA REZANJE STIROPORA

- Napon / frekvencija: 230 V / 50 Hz
- Potrošnja energije: 160 W
- Duljina reza: 117 cm
- Visina reza: 30 cm
- Zaštita: IP44
- Kut rezanja: 0° - 90°



oprema: Ni-Cr rezna žica, mesing četka za čišćenje, imbus ključ

Broj specifikacija
35330



1

**FESTA**

NOŽNI PREKIDAČ ZA REZAČ STIROPORA

za 35330, 35345, 35348



Broj Specifikacija

35334

1

**FESTA**

STALAK ZA REZAČ STIROPORA

za 35330, 35345, 35348



Broj Specifikacija

35336

1

**FESTA**

REZERVNA OPRUGA ZA REZAČ STIROPORA

za 35330, 35345, 35348



Broj Specifikacija

35332

1

**FESTA**

DRŽAČ ZA REZAČ STIROPORA

za 35330, 35345, 35348



Broj Specifikacija

35333

1

**FESTA**

REZERVNI STRUJNI ADAPTER ZA REZAČ STIROPORA

za 35330, 35345, 35348



napon/frekvencija: 230 V / 50Hz

izlaz: 36 V / 5 A

Potrošnja energije: 200 W



Broj Specifikacija

35347

1

REZERVNI NIZ Cr-Ni ZA REZAČ STIROPORA



Broj Specifikacija

35331 za rezač 117 cm**35346** za rezač 137 cm

1





FESTA

BEŽIČNI STROJ ZA REZANJE STIROPORA

- baterija: 36 V, 1,5Ah Li-ion
- Potrošnja energije: 180 W
- Temperatura: max 350 C°
- Duljina noža: 20 cm
- oprema: 2 baterije, punjač, oštrica, mesing četka za čišćenje, imbus ključ



Broj	specifikacija	
35323	električni rezač stiropora	1
35328	rezervni nož za rezač stiropora 14 cm	1
35329	rezervni nož za rezač stiropora 25 cm	1

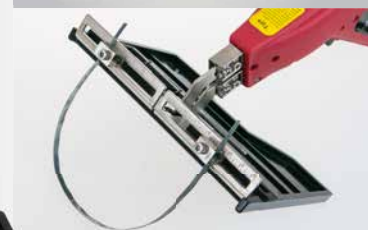

FESTA

STROJ ZA REZANJE STIROPORA

- Napon / frekvencija: 230 V/50 Hz
- Potrošnja energije: 250 W
- Temperatura: 50-600 C°
- Duljina noža: 25 cm
- Duljina dovodnog kabela: 3 m



- oprema: četka za čišćenje mesinga, imbus, nož 25 i 30 cm

Broj	specifikacija	
35326	električni rezač stiropora	1
35328	rezervni nož za rezač stiropora 14 cm	1
35329	rezervni nož za rezač stiropora 25 cm	1



VODILICA ZA REZANJE POLISTIRENA

· za 35323, 35326

Broj	specifikacija	
35327	vodilica za rezanje polistirena	1
35335	rezervni nož - dužina 30 cm	1



FESTA

STROJ ZA REZANJE STIROPORA



- regulacija temperature

Broj	specifikacija	
35325	220 W	1



FESTAGLODALICA
ZA STIROPOR

ALU



Broj	specifikacija	
24752	Ø 65 mm	1
24753	Ø 70 mm	1



GLODALICA ZA STIROPOR

Broj	specifikacija	
24727	Ø 65 mm	1
24729	Ø 68 mm	1
24728	Ø 70 mm	1

FASADNA
TIPLA

100x

MADE IN
EU

Broj	specifikacija		Broj	specifikacija	
39210	Ø 10 x 100 mm	1	39218	Ø 10 x 180 mm	1
39212	Ø 10 x 120 mm	1	39217	Ø 10 x 200 mm	1
39214	Ø 10 x 140 mm	1	39219	Ø 10 x 220 mm	1
39216	Ø 10 x 160 mm	1			

FESTATIPLA U IZOLACIJU ZA
ČAHURE VODEĆEG VIJKA

2x

Broj	specifikacija			
39240	bijela	M10		1
39241	siva	M10		1
39242	antracit	M10		1
39243	smeđa	M10		1
39244	crno	M10		1



PODLOŽAK

za vijke Ø 6 i 8 mm

50x

Broj	Specifikacija	
39208	Ø 68 mm	1



VALJAK ZA PODNE MASE

MADE IN
EU

Broj	dijameter	visina šiljci	dužina	
38950	Ø 69 mm	12 mm	25 cm	10
38951	Ø 69 mm	12 mm	40 cm	8
38952	Ø 122 mm	34 mm	25 mm	10
38953	Ø 122 mm	34 mm	40 cm	8
38954	Ø 122 mm	34 mm	60 mm	4

PODLOŽAK

Broj	specifikacija	
39206	Ø 40 mm	200
39207	Ø 60 mm	100

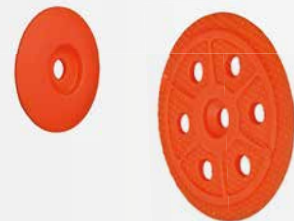

MOQ

POTPLAT
SA ŠILJCIMAMADE IN
EU

Broj	specifikacija	
38970	šiljci 25 mm	1
38971	šiljci 30 mm	1





PODLOŠKE ZA MREŽICU



Broj	specifikacija	
42420	Ø 30 mm	1



PLETIVO RABICO



Broj	specifikacija	
42312	1 m 50 bm 16 x 16 mm	1

DRVENA OBLOGA



Broj	dužina	debljina	širina	
37120	200 mm	1,7 mm	20 mm	10
37119	250 mm	1,7 mm	20 mm	10



SITO ZA ŠTUK (GIPS)



Broj	širina	visina	mrežica dimenzije	
37216	50 mm	50 mm	2 mm	1
37217	50 mm	50 mm	3 mm	1
37218	50 mm	50 mm	4 mm	1

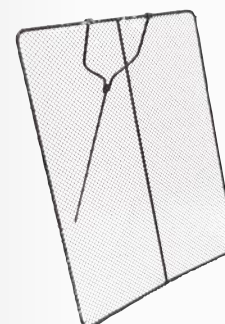

SITO

Broj	širina	visina	mrežica dimenzije	
37236	0,8 m	1 m	10 mm	1
37237	0,8 m	1 m	12 mm	1
37238	0,8 m	1 m	16 mm	1
37239	0,8 m	1 m	20 mm	1



STAKLENA VLAKNA ZA BETON

- +/- 150 g/ 50 kg cement
- 600 - 900 g/m² betona ili morta



Broj	težina	
42115	0,9 kg	9



MREŽA ZAŠTITNA ZELENA

Broj	specifikacija	
42120	2,5 x 20 m, 80 g/ m ² zelena	5



JEŽ ZA ŽBUKU



Broj		
37114		1



JEŽ ZA ŽBUKU



Broj	specifikacija	
37115		1



ZIDARSKA KAJLA

Zn		MOQ 10	
Broj	specifikacija		
37231	14 cm single	10	



ZIDARSKA KAJLA

MOQ 5		
Broj	specifikacija	
37232	14,5 cm	5



ZIDARSKA KAJLA

6x			
Broj	specifikacija		
37230	16 cm	6	

SPOJNICA ZA GREDE

Zn		
Broj	specifikacija	
37233	320 x 10 mm	100
37234	320 x 12 mm	100

SPOJNICA ZA GREDE

Broj	specifikacija	
37235	250 x 12 mm	1

PAPIRNATI KUTNIK SA ALU TRAKOM

ALU		
Broj	specifikacija	
39245	AL 30 m x 5 cm	1

PVC KUTNIK

MADE IN EU		
Broj	specifikacija	
39238	3 m	25

LOPATICA ZA GIPSANE PLOČE, PVC

PLASTIC		
Broj	specifikacija	
34308	50 mm	20
34307	80 mm	12
34306	100 mm	10
34305	150 mm	12

PODIZAČ GIPS KARTONSKE PLOČE

- dizanje 153 - 344 cm
- max. opterećenje. 54 kg

Broj	specifikacija		
26775		1	

KOMPLET ZA POSTAVLJANE GIPSANIH PLOČA

Broj	specifikacija	
34300	komplet 9 kom	10
34303	kadica	60

FESTA

DRŽAČ PLOČA

2x		
Broj	specifikacija	
36312		12

FESTA

DRŽAČ PLOČA

Broj	specifikacija	
36308	36 x 16,5 x 7,5 cm	10



HOBL
ZA GIPSANE PLOČE



Broj	specifikacija	
22120	250 x 40 mm	10



HOBL
ZA GIPSANE PLOČE



Broj	specifikacija	
22121	250 x 40 mm	10
22122	140 x 40 mm	6



HOBL
ZA GIPSANE PLOČE



Broj	specifikacija	
22126	155 x 40 mm	1



HOBL ZA GIPSANE PLOČE



Broj	specifikacija	
22125	Ø 250 x 40 mm	6



HOBL ZA GIPSANE PLOČE



Broj	specifikacija	
22124	Ø 250 x 16 mm	10



HOBL
ZA GIPSANE PLOČE



Broj	specifikacija	
22123	60 x 40 mm	6

FESTA

PILA ZA GIPSANE PLOČE



Broj	specifikacija	
24159	150 mm	12



HOBL
ZA GIPSANE PLOČE



Broj	specifikacija	
34315		10
34316	rezervna oštrica	1



PROREZAVAJUĆA PILA ZA GIPS PLOČE



Broj	specifikacija	
24190	300 mm	10

REZERVNA RAŠPA

Broj	specifikacija	
22130	250 x 40 mm	20
22129	155 x 40 mm	20
22132	140 x 40 mm	20
22133	60 x 40 mm	20
22134	Ø 16 x 250 mm	20

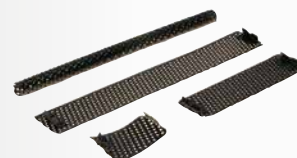

FESTA

PB PLAMENIK

· Ø 17, 22, 40 mm



Broj	specifikacija	
69918	2 kW, 3 m crijevo	10

**FESTA**

PB PLAMENIK

· Ø 25, 35, 50 mm



Broj	specifikacija	
69919	19,5 kW, 1,5 m crijevo	10

**FESTA**

PB PLAMENIK 300 mm



Broj	specifikacija	
69900	Ø 35 mm, dužina 300 mm, bez crijeva	10
69901	Ø 35 mm, dužina 300 mm + 3 m crijevo	5

**FESTA**

PB PLAMENIK + CRIJEVO 2M 3 KW



Broj	specifikacija	
69914	300 mm + 2 m crijevo	5

**FESTA**

PB PLAMENIK



Broj	specifikacija	
69902	Ø 55 mm, dužina 550 mm, bez crijeva	10

**FESTA**

PB PLAMENIK



Broj	specifikacija	
69903	Ø 55 mm, dužina 550 mm + 3 m crijevo	10

**FESTA**

PB PLAMENIK

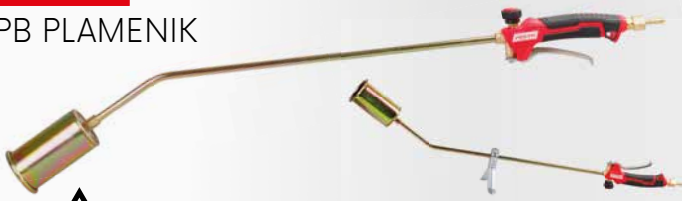

Broj	specifikacija	
69905	Ø 55 mm, dužina 900 mm, bez crijeva	10

**FESTA**

PB PLAMENIK



Broj	specifikacija	
69906	Ø 55 mm, dužina 900 mm + 3 m crijevo	5



FESTA

PB PLAMENIK



Ø 55 mm



Broj	specifikacija	
69904	60 kW, 850 mm, 5 m crijevo	8

FESTA

PB PLAMENIK

regulator za priključak 10 i 33 kg



Broj	specifikacija	
69917	Ø 60 mm, dužina 900 mm + 3 m crijevo 3 m	1

FESTA

CRJEVO PRO PB PLAMENIK

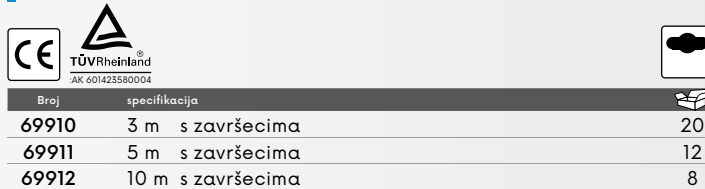

Broj	specifikacija	
69910	3 m s završecima	20
69911	5 m s završecima	12
69912	10 m s završecima	8



REDUKCIJSKI VENTIL P2 PB SA MANOMETROM

ulazni tlak	25 bar
izlazni tlak	0,5 - 4,0 bar
nazivni protok	16 kg h
ulaz	W 21,8 x 1 14" LH
izlaz	G3 8" LH

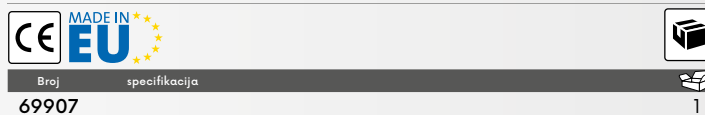

Broj	specifikacija	
69907		1

REDUKCIJSKI VENTIL

Izlazni tlak	4,0 bar
nazivni protok	16 kg h
ulaz	W 21,8 x 1 14" LH
izlaz	G3 8" LH

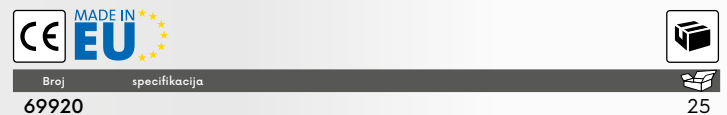

Broj	specifikacija	
69920		25

REDUKCIJSKI VENTIL

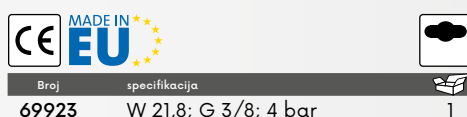

Broj	specifikacija	
69923	W 21,8; G 3/8; 4 bar	1

REGULATOR TLAKA

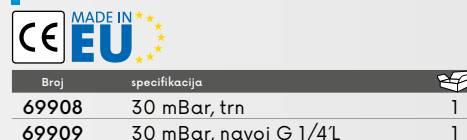

Broj	specifikacija	
69908	30 mBar, trn	1
69909	30 mBar, navoj G 1/4L	1

JEDNOSMJERNI TLAČNI VENTIL

out G 3/8L, for 2 kg PB bottle

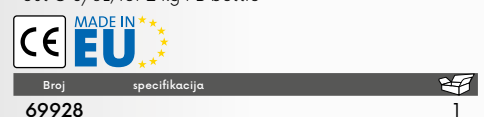

Broj	specifikacija	
69928		1

**FESTA****PLINSKI PLAMENIK NA NAVOJNOM ULOŠKU**

- max. temperatura. 1200 °C
- snaga 1,7 kW
- promjer plamena Ø 20 mm



Broj	specifikacija
69930	piezo

20

FESTA**PLINSKI PLAMENIK NA PROBOJNOM ULOŠKU**

- max. temperatura. 1200 °C
- snaga 1,7 kW
- promjer plamena Ø 20 mm



Broj	specifikacija
69931	piezo

12

**ZDJELICA ZA GIPS**

Broj	specifikacija
37121	konusna

ZDJELICA ZA GIPS

Broj	specifikacija
37122	niska

ZDJELICA ZA GIPS

Broj	specifikacija
33275	niska, guma

20

**POCINČANA KANTA****Zn**

Broj	specifikacija
39000	5 l
39001	10 l
39002	12 l
39003	15 l

ZIDARSKA KANTA

Broj	specifikacija
39005	5 l
39010	10 l
39012	12 l
39014	15 l sa naljevom
39020	20 l
39021	20 l sa naljevom

POSUDA

Broj	specifikacija
39192	30 l
39193	45 l

20

ZIDARSKA POSUDA OKRUGLA

Broj	specifikacija
39045	45 l Ø 54 x 27 cm
39065	60 l Ø 60 x 35 cm
39090	90 l Ø 66 x 35 cm

1

ZIDARSKA POSUDA ČETVRTASTVA

Broj	specifikacija
39145	40 l 71 x 40 x 21 cm
39165	65 l 71 x 40 x 30 cm
39190	85 l 77 x 48 x 30 cm

1

FESTA

• ručka otporna na udarce
najlon + stakloplastika

• 360° rotirajuća glava

• 3 preklopna položaja
povratni prekidač

• promjena doze
9:1 / 18:1

FESTA

PIŠTOLJ ZA SILIKON
S POVRATNIM PREKIDAČEM

Broj specifikacija
38027

1

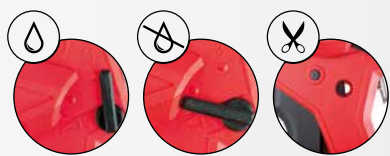

FESTA

PIŠTOLJ
ZA SILIKON
S POVRATNIM
PREKIDAČEM

Č.p. Specifikacije
38032 nylonová

24

FESTA

PIŠTOLJ
ZA SILIKON
S POVRATNIM
PREKIDAČEM

Broj specifikacija
38028

1



FESTA

PROFI PIŠTOLJ
"O"

Broj specifikacija
38013

12



FESTA

PROFI PIŠTOLJ
KOBRA

Broj specifikacija
38001

24



FESTA

PROFI PIŠTOLJ
KOBRA

Broj specifikacija
38012

6



FESTA

PROFI PIŠTOLJ
KOBRA

Broj specifikacija
38024

1



PIŠTOLJ EX



Broj	specifikacija	
38010	6 square	24

PIŠTOLJ
KOBRA

Broj	specifikacija	
38025		24

FESTAPIŠTOLJ
ZA KEM. TIPLE,
380 ML

Broj	specifikacija	
38020		12

PIŠTOLJ
ZA SILIKON
SCORPION

Broj	specifikacija	
38006		12

PIŠTOLJ EX



Broj	specifikacija	
38002	šesterokutna osovina	24

PIŠTOLJ
ZA SILIKON
PLASTIČNI RAM

Broj	specifikacija	
38003	šesterokutna osovina	24

PIŠTOLJ
ZA SILIKON
KROM

Broj	specifikacija	
38007		24

PIŠTOLJ
ZA SILIKON
POLUZATVORENI
PLASTIČNI

Broj	specifikacija	
38008		24

PIŠTOLJ
ZA SILIKON
NAZUBLJENA
VODILICA

Broj	specifikacija	
38009		24

PIŠTOLJ
ZA SILIKON
HOBBY

Broj	specifikacija	
38000		24

FESTA

PIŠTOLJ ALU



ALU

Broj	specifikacija	
38005	310 ml	20
38014	vrha 3 kom	100

FESTA

PIŠTOLJ ALU



ALU

Broj	specifikacija	
38004	600 ml	12
38014	vrha 3 kom	100

FESTA

PROFESIONALNI
PIŠTOLJ
ZA PU PJENU
TEFLON



TEFLON

Broj	specifikacija	
38018		20

FESTA

PIŠTOLJ ZA
PU PJENU
TEFLON



TEFLON

Broj	specifikacija	
38017		20

FESTA

PIŠTOLJ ZA
PU PJENU



TEFLON

TEFLON

Broj	specifikacija	
38016		20

FESTA

PIŠTOLJ ZA
PU PJENU



TEFLON

TEFLON

Broj	specifikacija	
38015		20

PIŠTOLJ ZA
PU PJENU



Broj
38031

specifikacija

20

FESTA

PIŠTOLJ ZA
PU PJENU



Broj
38022

specifikacija
ABS

20

PIŠTOLJ ZA
PU PJENU



Broj
38021

specifikacija

24

REZERVNA MLAZNICA
ZA PIŠTOLJ ZA PU PJENU

- za pištolj 38015, 38016, 38017, 38018

TEFLON

Broj
38030

specifikacija

5





KIST, PLASTIČNA DRŠKA

Broj	širina	debljina	dužina	
52212	20 mm	15 mm	40 mm	12
52213	30 mm	15 mm	45 mm	12
52214	40 mm	15 mm	45 mm	12
52215	50 mm	15 mm	50 mm	12
52216	60 mm	15 mm	60 mm	12
52217	70 mm	15 mm	65 mm	12
52218	80 mm	15 mm	65 mm	12
52220	100 mm	15 mm	70 mm	12



KIST, PLASTIČNA DRŠKA

Broj	širina	debljina	dužina	
52202	20 mm	12,5 mm	38 mm	12
52203	30 mm	13 mm	38 mm	12
52204	40 mm	14 mm	44 mm	12
52205	50 mm	16 mm	44 mm	12
52206	60 mm	17 mm	52 mm	12
52208	80 mm	17 mm	52 mm	12
52207	100 mm	18 mm	52 mm	12

KIST RADIJATOR,
PLASTIČNA DRŠKA

Broj	širina	debljina	dužina	
52283	25 mm	10 mm	44 mm	12
52284	38 mm	10 mm	44 mm	12
52285	50 mm	10 mm	44 mm	12
52286	62 mm	10 mm	50 mm	12
52288	76 mm	10 mm	50 mm	12

KISTOVI - KOMPLET,
PLASTIČNA DRŠKA

3x

Broj	specifikacija	
52070	20, 30, 50 mm	50



OKRUGLA ČETKA PROFI

MADE IN EU

Broj	specifikacija	
52075	Ø 90 mm	10



ČETVRTASTA ČETKA PROFI

MADE IN EU

Broj	širina	dužina	
52076	170 mm	80 mm	10

KISTOVI - KOMPLET,
PLASTIČNA DRŠKA

5x

Broj	specifikacija	
52071	15 mm, 25 mm, 40 mm, 60 mm, 80 mm	50



OKRUGLA ČETKA

Broj	širina	dužina	
52077	Ø 105 mm	70 mm	12







ČETVRTASTA ČETKA

Broj	širina	dužina	
52078	170 mm	70 mm	12





PRIMJENA VALJKA		BOJE I LAKOVI												
MATERIAL	DIMENZIJE / mm	DISPERZIJA	PROTIV KOROZIJE	SMOLA	ULJNI	VODOOTPORAN	POLIESTERNI	VEZIVA	LAZURE	LATEKOM	EPOKOMIDI	2-KOMPONENTNI	DEBELOSLOJNI	AKRILNI
PES	20	•						•		•			•	
PES	20	•	•			•		•		•				•
PAC	18	•						•		•				
PAC	12, 13	•								•				
PAD	18, 21	•								•				
PAD	13	•	•							•				
JANJEĆA DLAKA	23	•								•				
NYLON	13		•	•	•	•	•			•	•	•		
VELUR	4		•	•			•				•	•	•	
MIKROFIBRA	10								•	•				
SPUŽVA				•		•								•

VALJAK ZA BOJANJE, POLIAKRIL

PAC					
MADE IN EU					
Broj					
52331	100 mm	Ø 6 mm	Ø 17 mm	12 mm	50
52334	250 mm	Ø 8 mm	Ø 48 mm	12 mm	10







VALJAK ZA BOJANJE, POLIAKRIL

PAC					
MADE IN EU					
Broj					
52391	polster 5 250 mm	Ø 8 mm	Ø 54 mm	18 mm	10







VALJAK ZA BOJANJE, POLIAKRIL

PAC					
MADE IN EU					
Broj					
52328	polster 5 250 mm	Ø 8 mm	Ø 54 mm	18 mm	10
52456	polster 7 250 mm	Ø 8 mm	Ø 67 mm	18 mm	10







VALJAK ZA BOJANJE, POLIAKRIL

PAD					
MADE IN EU					
Broj					
52428	polster 7 250 mm	Ø 8 mm	Ø 67 mm	18 mm	10







VALJAK ZA LAKIRANJE, NYLON

PAD					
MADE IN EU					
Broj					
52421	100 mm	Ø 6 mm	Ø 17 mm	13 mm	50
52424	250 mm	Ø 8 mm	Ø 48 mm	13 mm	10







VALJAK ZA BOJANJE, POLIESTER

PES					
MADE IN EU					
Broj					
52305	180 mm	Ø 6 mm	Ø 42 mm	20 mm	10
52306	250 mm	Ø 6 mm	Ø 42 mm	20 mm	10



VALJAK ZA LAKIRANJE, POLIESTER FINA PJENA

MADE IN EU					
Broj					
52471	straight	100 mm	Ø 6 mm	Ø 35 mm	50



SET ZA BOJANJE

PAC

MADE IN EU



Broj	specifikacija	1
52600	polster 4 180 mm Ø 8 mm Ø 53 mm 18 mm	1



SET ZA BOJANJE

PES

MADE IN EU

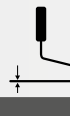

Broj	specifikacija	25
52610	180 mm Ø 6 mm Ø 42 mm 20 mm	25
52605	250 mm Ø 6 mm Ø 42 mm 20 mm	20



SET ZA BOJANJE

- 1x valjak za bojanje PAD 13mm/10 cm
- 1x valjak za bojanje PAC 12mm/10 cm
- 1x valjak za bojanje/ PES 11cm
- držač + posuda

MADE IN EU

Broj	specifikacija	10
52602		10



VALJAK ZA KUTEVE, POLIAKRIL

PAC

MADE IN EU

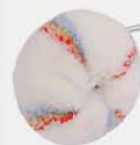

Broj	specifikacija	1
52601	sa držacem Ø 6 mm 18 mm	1



KADICA

MADE IN EU



Broj	specifikacija	1
52662	150 x 270 mm 100 mm	1
52666	260 x 290 mm 180 mm	1
52671	330 x 340 mm 250 mm	1



POSUDA ZA BOJU

MADE IN EU

Broj	specifikacija	25
52694	8 l	25
52695	12 l	20



MREŽICA

MADE IN EU



Broj	širina	visina	100
52652	230 mm	250 mm	100
52656	270 mm	290 mm	100



DRŽAČ VALJKA

MADE IN EU



DRŽAČ VALJKA



Broj	specifikacija	100
52640	5 cm Ø 6 mm	100
52645	8,5 cm Ø 6 mm x 27 mm	100

MADE IN EU

Broj	specifikacija	100
52630	18 cm Ø 6 mm	100
52635	25 cm Ø 6 mm	100
52620	18 cm Ø 8 mm	50
52625	25 cm Ø 8 mm	50

STRUGAČ ZA BOJE I LAKOVE

Broj	specifikacija	12
37005		12





FESTA

TELESKOPSKI ŠTAP

navoj za 31610, 34203

Broj	Specifikacija	
52011	88 - 140 cm	1



TELESKOPSKI ŠTAP

ALU

Broj	dužina		
52010	120 cm	ALU	50
52012	240 cm	ALU	25



TELESKOPSKI ŠTAP

Broj	dužina		
52020	300 cm	metal	10



TELESKOPSKI ŠTAP

Broj	dužina		
52030	240 cm	fiberglass	6



ZAŠTITNA TRAKA SA FOLIJOM

Broj	širina	dužina	
37243	55 cm	30 m	60
37244	110 cm	30 m	30
37245	140 cm	30 m	30
37246	180 cm	15 m	30
37290	210 cm	20 m	30
37247	240 cm	15 m	30
37291	270 cm	16 m	30



KOMBINACIJA S KAPULJAČOM

Broj	specifikacija	
50585	veličina M	1
50586	veličina L	1
50587	veličina XL	1
50588	veličina XXL	1



ZAŠTITNA FOLIJA

Broj	specifikacija	
37248	1,2 x 2,2 m 100 µm traka 45 mm x 25 m	25



ZAŠTITNA FOLIJA

Broj	objem	material debljina	
37250	4 x 5 m	0,007 mm	100
37251	4 x 12,5 m	0,007 mm	50
37252	2 x 50 m	0,007 role	20



UNIVERZALNA FOLIJA

Broj	specifikacija	material debljina	
37253	4 x 5 m	0,03 mm	100

VALOVITI KARTON



Broj	širina	dužina	
54008	1 m	10 m	1

FESTA



PE ZAŠTITNA FOLIJA PROFI

plava - srebrna



Broj	specifikacija	
25206	2 x 3 m	25
25212	3 x 4 m	10
25215	3 x 5 m	8
25220	4 x 5 m	8
25224	4 x 6 m	8
25230	5 x 6 m	8

Broj	specifikacija	
25240	5 x 8 m	4
25248	6 x 8 m	3
25260	6 x 10 m	3
25296	8 x 12 m	2
25350	10 x 15 m	1



PE ZAŠTITNA FOLIJA

plava



Broj	specifikacija	
25369	2 x 2 m	50
25370	2 x 3 m	20
25371	3 x 4 m	10
25372	3 x 5 m	10
25373	4 x 5 m	10

Broj	specifikacija	
25374	4 x 6 m	5
25376	5 x 8 m	5
25378	6 x 10 m	2
25379	8 x 12 m	2
25380	10 x 15 m	2

PE ZAŠTITNA FOLIJA STANDARD

plava - srebrna



Broj	specifikacija	
25155	2 x 2 m	50
25006	2 x 3 m	50
25009	3 x 3 m	35
25012	3 x 4 m	20
25015	3 x 5 m	10
25016	4 x 4 m	10
25020	4 x 5 m	10
25024	4 x 6 m	10

Broj	specifikacija	
25025	5 x 5 m	10
25030	5 x 6 m	10
25040	5 x 8 m	5
25048	6 x 8 m	5
25060	6 x 10 m	5
25096	8 x 12 m	2
25150	10 x 15 m	2
25153	15 x 20 m	1

PE ZAŠTITNA FOLIJA STANDARD

zelena



Broj	specifikacija	
25179	2 x 2 m	50
25180	2 x 3 m	50
25195	2 x 8 m	20
25181	3 x 4 m	20
25182	3 x 5 m	10
25183	4 x 5 m	10

Broj	specifikacija	
25184	4 x 6 m	10
25186	5 x 8 m	5
25188	6 x 10 m	5
25189	8 x 12 m	2
25190	10 x 15 m	2

PE ZAŠTITNA FOLIJA PROFI

zelena-zelena



Broj	specifikacija	
25160	2 x 3 m	15
25171	2 x 8 m	1
25162	3 x 5 m	5
25163	4 x 5 m	4

Broj	specifikacija	
25164	4 x 6 m	3
25167	6 x 8 m	2
25169	8 x 12 m	1
25170	10 x 15 m	1

PE ZAŠTITNA FOLIJA OKRUGLA

plava - srebrna



Broj	specifikacija	
25003	Ø 3,6 m	15
25004	Ø 4,5 m	5
25005	Ø 5,5 m	4
25002	Ø 6,5 m	3



NAPINJAČ ZA CERADE

4x

Broj	specifikacija	
25400	20 cm	1

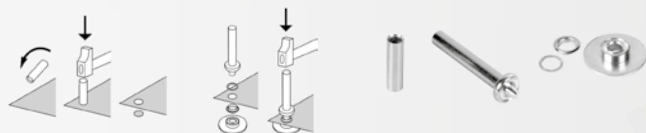

APLIKATOR PRSTENA ZA CERADU

Broj	specifikacija	
25410	aplikator + 25 prstena	1



PRSTEN ZA CERADU

10x

Broj	specifikacija	
25001		1





TELESKOPSKE SKLOPIVE LJESTVE

· maks. opterećenje 150 kg



Broj	specifikacija	
48415	1,9 / 3,8 m	6/12 gazište

1

TELESKOPSKE LJESTVE

· maks. opterećenje 150 kg



Broj	specifikacija	
48410	3,2 m	11 gazište
48411	3,8 m	13 gazište

1

SKLOPIVA RADNA PLATFORMA

· maks. opterećenje 150 kg

ALU

Broj	specifikacija
48420	

1



NEW

2.75m	H L	H L	1.73m	0.93m	0.99m
	1.60m 1.14m	1.69m 1.32m			

RADNA PLATFORMA

KG
13,6

· max 150 kg

Broj	specifikacija
37660	

1





PODESIVI GRAĐEVINSKI POTPORANJ



Broj	specifikacija	
37545	140 cm, visina 98 - 165 cm	1
37546	120 cm, visina 98 - 165 cm	1



PODESIVI POTPORNİ DRŽAČ

· 48449 kavez za podesive rekvizite



Broj	specifikacija	
48452	160 - 290 cm	1
48453	180 - 320 cm	1
48454	200 - 360 cm	1
48455	250 - 440 cm	1
48456	260 - 380 cm	1
48457	220 - 400 cm	1

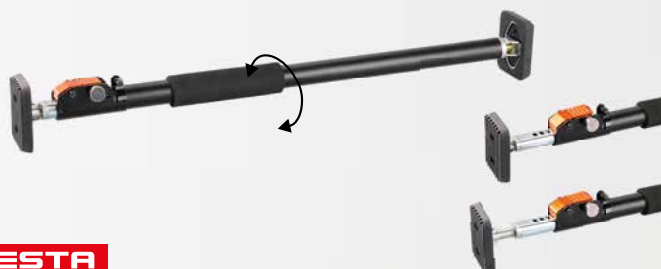

FESTA

PODEŠAVAJUĆI POTPORANJ

· maks. opterećenje 40 kg

Broj	specifikacija		
52060	66 - 115 cm	1	
52065	160 - 290 cm	1	



PODEŠAVAJUĆI POTPORANJ

Broj	specifikacija		
52050	50 - 115 cm	1	
52055	115 - 290 cm	1	

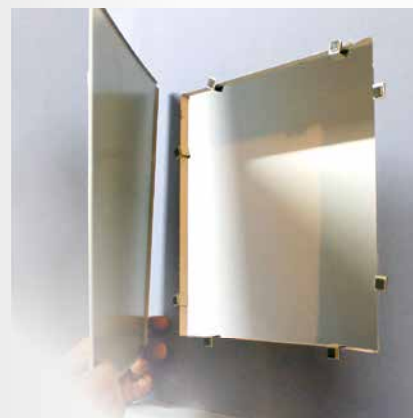

REVIZIONA OKNA MAGNETSKI

	Broj	specifikacija	
	82100	10 - 21 cm	1
	82101	20 - 31 cm	1
	82102	30 - 41 cm	1
	82103	40 - 51 cm	1
	82104	50 - 58 cm	1



VRATA ZA DIMNJAK TIN



Broj	specifikacija	
65062		1



VRATA ZA DIMNJAK TIN



Broj	specifikacija	
65063	siva	1
65064	bijela	1



VRATA ZA DIMNJAK TIN



Broj	specifikacija	
65065		1



310

WINLAND ŠKARE



312

ŠKARE



315

MAČETE I VRTNI ALATI



315

VRTNE PILE



316

SJEKIRE



318

VRTNI ALATI



320

BRUS



321

STRUNE ZA KOSILICU



321

PVC TKANINA



322

VRTNI POTPORNİ STUP



324

RASPRŠIVACI I SPOJNICE
ZA CRIJEVA

332

SPOJNICE CRIJEVA



333

CRIJEVA I DRŽACI CRIJEVA



334

KANTA ZA ZALIJEVANJE
I VENTILI

335

TLACNI RASPRŠIVAC
I KOMPRESOR

337

GRABLJE



341

ŠTIHACE, LOPATE I VILE

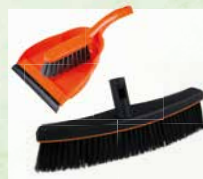

348

METLE

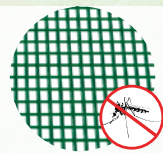

350

DRŽALA DRVENA I ALU
FIBERGLAS

352

ZAŠTITNA MREŽICA

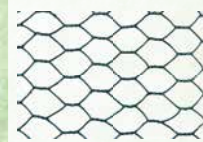

353

OGRADE I PLETIVA



356

SIDRO I SIDRENI VIJAK



357

MREŽA - SJENILO



358

PRIBOR ZA ROŠTILJ



ALATI I PRIBOR ZA VRT 308 - 359



WINLAND®
ŠKARE

Broj	specifikacija	
45020	205 mm	10
44980	Zamjenska opruga	1

WINLAND®
ŠKARE

Broj	specifikacija	
45023	205 mm	10
44980	Zamjenska opruga	1

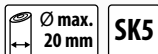
WINLAND®
ŠKARE

Broj	specifikacija	
45063	215 mm	10
44981	Zamjenska opruga	1

WINLAND®
ŠKARE

Broj	specifikacija	
44972	215 mm	10
44981	Zamjenska opruga	1

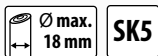
WINLAND®
ŠKARE

Broj	specifikacija	
45099	190 mm	10
44983	Zamjenska opruga	1

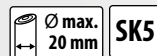
WINLAND®
ŠKARE

Broj	specifikacija	
45098	220 mm	10
44983	Zamjenska opruga	1



WINLAND®

WINLAND®
ŠKARE

Broj	specifikacija	
45095	200 mm	10
44982	Zamjenska opruga	1

WINLAND®
ŠKARE

· turning handle



Broj	specifikacija	
45096	220 mm	6
44982	Zamjenska opruga	1

WINLAND®
ŠKARE



INOX max. mm **INOX**

Broj	specifikacija	
45089	160 mm	10

WINLAND®
ŠKARE



SK5 **TEFLON** **SK5** **TEFLON**

Broj	specifikacija	
45097	210 mm	10
44981	Zamjenska opruga	1

WINLAND®
ŠKARE



Ø max. 10 mm **INOX**

Broj	specifikacija	
45088	160 mm	10

WINLAND®

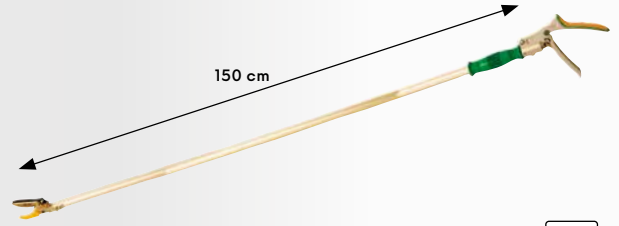

Ø max. 12 mm

ŠKARE TELESKOPSKE

Broj	specifikacija	
45017		10

WINLAND®



REZERVNA OPRUGA

Broj	for pruners	
44981	45021, 45025, 45063, 45097	1
44980	45020, 45023	1
44983	45098, 45099	1
44982	45027, 45095, 45096	1
44984	45110, 45014, 45026	1
44985	45018	1

WINLAND®

REZERVNA OŠTRICA ZA VRTNE ŠKARE



za škare 45095, 45027

Broj	specifikacija	
45094		20



WINLAND®

ŠKARE ZA GRANE



Ø max. 45mm **SK5** **TEFLON**

Broj	specifikacija	
44991	76 cm	12

WINLAND®

ŠKARE ZA GRANE TELESKOPSKE



Ø max. 45mm **SK5** **TEFLON**

Broj	specifikacija	
44992	70 - 103 cm	10



ŠKARE ZA ŽIVICU

TEFLON



Broj	specifikacija	
44996	61 cm, valovita oštrica	12



ŠKARE ZA ŽIVICU

TEFLON



Broj	specifikacija	
44997	61 cm, ravna oštrica	12



ŠKARE ZA TRAVU 360°

Broj	specifikacija	
44998		6



BRUS ZA NOŽEVE I ŠKARE 6 U 1

Broj	specifikacija	
45068		10



BRUS ZA NOŽEVE I ŠKARE

Broj	specifikacija	
45048		20



FESTA

ŠKARE

· drška presvučena najlonom



Broj	specifikacija	
45021	210 mm	6



ŠKARE



Broj	specifikacija	
45019	210 mm	10



FESTA

ŠKARE

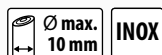

Broj	specifikacija	
45010	190 mm	12
44984	Zamjenska opruga	1



ŠKARE



Broj	specifikacija	
45014	190 mm	12
44984	Zamjenska opruga	1



ŠKARE



Broj	specifikacija	
45026	150 mm	12
44985	Zamjenska opruga	1



ŠKARE

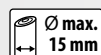

Broj	specifikacija	
45018	210 mm kovani	10



ŠKARE



Broj	specifikacija
45025	200 mm



Broj	specifikacija
45025	200 mm

ŠKARE

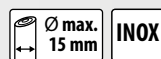

Broj	specifikacija
44970	210 mm



Broj	specifikacija
44970	210 mm

ŠKARE

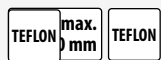

Broj	specifikacija
45027	200 mm



Broj	specifikacija
45027	200 mm

ŠKARE



Broj	specifikacija
45029	200 mm



Broj	specifikacija
45029	200 mm

ŠKARE

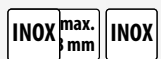

Broj	specifikacija
44971	160 mm



Broj	specifikacija
44971	160 mm

ŠKARE

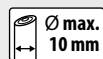

Broj	specifikacija
45016	180 mm



Broj	specifikacija
45016	180 mm

ŠKARE

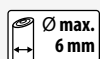

Broj	specifikacija
45015	190 mm, ravne



Broj	specifikacija
45015	190 mm, ravne

FUTROLA ZA ŠKARE



Broj	specifikacija
37317	

Broj	specifikacija
37317	

ŠKARE ZA TRAVU

Broj	specifikacija
45011	300 mm



Broj	specifikacija
45011	300 mm

ŠKARE ZA TRAVU 180°

Broj	specifikacija
45012	370 mm, 180° okretne



Broj	specifikacija
45012	370 mm, 180° okretne

ŠKARE ZA GRANE

• ručke presvučene najlonom



Broj	specifikacija
44999	540 mm, zaobljene



Broj	specifikacija
44999	540 mm, zaobljene

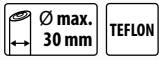

FESTAŠKARE
ZA GRANE

Broj	specifikacija	
45000	750 mm, zaobljene	6

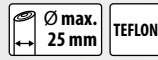
FESTAŠKARE
ZA GRANE

Broj	specifikacija	
45001	710 mm, zaobljene	6

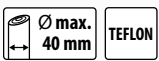
FESTAŠKARE
ZA GRANE

Broj	specifikacija	
45002	750 mm, sa zapinjačem	12

ŠKARE
ZA GRANE
TELESKOPSKE

Broj	specifikacija	
45003	660-900 mm, teleskopske	6

FESTA

ŠKARE ZA GRANE

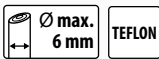

Broj	specifikacija	
45005	580 230 mm, valovita oštrica	6

FESTA

ŠKARE



Broj	specifikacija	
45006	580 230 mm, ravna oštrica	6

FESTA

ŠKARE TELESKOPSKE



Broj	specifikacija	
45007	670-870 230 mm, valovita oštrica	6

ŠKARE



Broj	specifikacija	
44995	440 160 mm	12

ŠKARE

Broj	specifikacija	
45009	500 190 mm, valovita oštrica	6

ŠKARE

Broj	specifikacija	
45008	500 190 mm, ravna oštrica	6

SRP

Broj	specifikacija	
45490	450 mm	1



FESTA
MAČETA



TEFLON

Broj	specifikacija	
45069	440 mm	6

FESTA
MAČETA



TEFLON

Broj	specifikacija	
44950	490 mm	4

MAČETA
ROST FREI



INOX

Broj	specifikacija	
45083	430 mm	12
45084	600 mm	6

MAČETA



· drška od jasena

Broj	specifikacija	
45081	510 mm	36
45082	710 mm	36

FESTA
PREKLOPNA PILA



· 3x brušeni i kaljeni zubi

Broj	specifikacija	
45061	150 mm s poklopcem ručke	12

FESTA
PREKLOPNA PILA



· 3x brušeni i kaljeni zubi

Broj	specifikacija	
45060	180 mm	6

FESTA
PILA



· 3x brušeni i kaljeni zubi

Broj	specifikacija	
45062	260 mm sa futrolom	24

FESTA
PROREZAVAJUĆA PILA



· 3x brušeni i kaljeni zubi

Broj	specifikacija	
24152	350 mm 7 tpi	12

FESTA
TELESKOPSKA PILA

· 3x brušeni i kaljeni zubi

Broj	specifikacija	
45033	230 - 490 mm	1



PILA
GUSJENICA



Broj	specifikacija	
45030	pila 30 cm	6
45031	pila 30 cm	6

TELESKOP ŠTAP
ZA PILU



Broj	specifikacija	
45032	Teleskop štap	6

FESTA



FESTA

SJEKIRA

DIN
5131DIN
7294

- drška od jasena
- kružni klin



Broj	specifikacija		Broj	specifikacija	
19380	600 g	1	19384	1400 g	1
19381	800 g	1	19385	1600 g	1
19382	1000 g	1	19387	2000 g	1
19383	1250 g	1			

FESTA

SJEKIRA
TESARSKA

- drška od jasena



Broj	specifikacija	
19340	700 g	22

FESTA

SJEKIRA - KALAČ

- drška od jasena
- kružni klin

DIN
5129

Broj	specifikacija	
19389	3000 g	1
19388	4000 g	1



FESTA

SJEKIRA

- drška od jasena
- kružni klin

DIN
7294

Broj	specifikacija	
19391	2000 g	1



FESTA

SJEKIRA FIBERGLASS

- drška fiberglass

Č.p.	specifikace	
19326	600 g	6
19328	800 g	24
19330	1000 g	12
19332	1250 g	8
19333	1500 g	6
19335	1600 g	6
19337	2000 g	6



FESTA

SJEKIRA
FIBERGLASS

- drška fiberglass

Č.p.	specifikace	
19392	1000 g	6



FESTA

SJEKIRA
KAMPERSKA

- drška fiberglass

Č.p.	specifikace	
19301	500 g	6



FESTA

SJEKIRA FIBERGLASS

- drška fiberglass

Broj	specifikacija	
19390	2000 g	6





FESTA

SJEKIRA KALAČ FIBERGLASS

drška fiberglass

Broj	specifikacija	
19370	3000 g	4
19371	4000 g	4



DRŠKA OD JASENA



Č.p.	specifikace	pro sekeru	
61340	36 cm	19380	10
61341	40 cm	19381, 19340	10
61342	50 cm	19382	10
61343	70 cm	19383, 19384	10
61344	80 cm	19385, 19391	10
61345	90 cm	19387	10
61346	90 cm	19388, 19389	10

SJEKIRA

Č.p.	specifikace	
19306	600 g	24
19308	800 g	24
19310	1000 g	24
19312	1250 g	12
19314	1500 g	12



KLIN ZA KALANJE

Broj	specifikacija	
19397	2000 g 55 x 210 x 45 mm	10
19465	2500 g 65 x 230 x 45 mm	10



KLIN ZA KALANJE PVC



Broj	specifikacija	
19462	175 x 65 x 20 mm	1
19463	230 x 70 x 30 mm	1
19464	240 x 75 x 40 mm	1



KLIN

Broj	specifikacija	
19394	1000 g 35 x 180 x 40 mm	6
19395	2000 g 40 x 255 x 55 mm	6
19396	2500 g 40 x 260 x 55 mm	8



TRN ZA CIJEPANJE SDS+

SDS+

Broj	Specifikacija	
19393	Ø 32 x 132 mm	10
19374	Ø 42 x 145 mm	10



KLIN ZA KALANJE

Broj	specifikacija	
19469	2500 g 165 x 87 mm	10

LOPATICA
ŠIROKÁ
ROST FREI

INOX



Broj	specifikacija	
45056	360 mm	12

LOPATICA
USKA
ROST FREI

INOX



Broj	specifikacija	
45057	360 mm	12

LOPATICA MALA
ROST FREI

INOX



Broj	specifikacija	
45058	270 mm	12

ALAT
ZA PLJEVLJENJE
SA LOPATICOM

INOX



Broj	specifikacija	
45059	360 mm	12

LOPATICA
ŠIROKÁ
NYLON

NYLON



Broj	specifikacija	
45065	280 mm	1

LOPATICA
USKA
NYLON

NYLON



Broj	specifikacija	
45066	310 mm	1

VRTNA VILICA
NYLON

NYLON



Broj	specifikacija	
45067	290 mm	1

KOMPLET
ALATA

HOBBY 4x



Broj	specifikacija	
45035	240 mm	35

MOTIKA
PLOSNATA S DRŽALOM

Broj	specifikacija	duljina ručke	
61294	140 mm	27 cm	MOQ 3
61221	držalo	27 cm	1



MOTIKA
ŠPIĆASTA S DRŽALOM

Broj	specifikacija	duljina ručke	
61295	140 mm	27 cm	MOQ 3
61221	držalo	27 cm	1



MOTIKA
S DRŽALOM

Broj	specifikacija	duljina ručke	
61296	175 mm	27 cm	MOQ 3
61221	držalo	27 cm	1



GRABLJE
ZA RAHLITI
ZEMLJU

Broj	specifikacija	duljina ručke	
61297		27 cm	MOQ 3
61221	držalo	27 cm	1





LOPATA KAMPERSKA

· torbica

Broj	specifikacija	
61085	410 mm	6



SADILICA LUKOVICA

INOX

Broj	specifikacija	
45040	230 mm	60



KOLČIĆ ZA SAĐENJE "T"

Broj	specifikacija	
45038	280 mm	60



NOŽ NA TRAVU

Broj	specifikacija	
45079	200 mm	1



NOŽ NA TRAVU

Broj	specifikacija	
45080	200 mm „L“	1



BERAČICA



Broj	specifikacija	
45041		75



BERAČICA

Broj	specifikacija	
45039		50
45034	170 - 300 cm, teleskop štap	5



SADILICA

Broj	specifikacija	
44955	950 mm	16



KULTIVATOR

Broj	specifikacija	
45042	160 x 132 cm	12



KULTIVATOR

Broj	specifikacija	
44053		12
61251	160 cm drška	1



KOLICA ZA POSIPAVANJE

SPECIFIKACIJA

višina:	111 cm
širina:	55 cm
volume:	12 l

Broj	specifikacija	
45085	12 l	1

FESTA

BRUS ZA NOŽEVE I ŠKARE 16v1



	30° Anvil	
	45° Anvil	
	50° Anvil	
	23° Bypass	
	35° Bypass	
	65° Bypass	
	Deburrr Tool	



Broj 45073 specifikacija 1



BRUS ZA NOŽEVE I ŠKARE 6 V 1

Broj 45068 specifikacija 10



BRUS ZA NOŽEVE I ŠKARE

Broj 45048 specifikacija 20



BRUS ZA KOSU

Broj 45046 specifikacija 100



OVALNI BRUS

Broj 45370 specifikacija 20



BRUS ZA NOŽEVE

Broj 45045 specifikacija 10



BRUS ZA NOŽEVE I ŠKARE

Broj 16991 specifikacija 20



BRUS ZA NOŽEVE I ŠKARE

Broj 16990 specifikacija 50





STRUNA ZA KOSILICU



Broj	specifikacija	
45530	2 mm x 15 m	1
45531	2,4 mm x 15 m	1
45532	3 mm x 15 m	1
45533	3,15 mm x 15 m	1
45534	4 mm x 15 m	1



STRUNA ZA KOSILICU



STRUNA ZA KOSILICU

Broj	specifikacija	
45520	2 mm x 162 m	10
45521	2,4 mm x 112 m	10
45528	2,7 mm x 90 m	10
45522	3 mm x 72 m	10
45525	2 mm x 162 m	10
45526	2,4 mm x 112 m	10
45529	2,7 mm x 90 m	10
45527	3 mm x 72 m	10

Broj	specifikacija	
45500	1,3 mm x 15 m	30
45502	1,3 mm x 15 m	30
45503	1,6 mm x 15 m	20
45505	1,6 mm x 15 m	20
45506	2 mm x 15 m	12
45508	2 mm x 15 m	12
45517	2 mm x 15 m	10
45509	2,4 mm x 15 m	12
45511	2,4 mm x 15 m	12
45512	2,4 mm x 15 m	12
45518	2,4 mm x 15 m	10
45523	2,7 mm x 15 m	10
45524	2,7 mm x 15 m	10
45513	3 mm x 15 m	10
45515	3 mm x 15 m	10
45516	3 mm x 15 m	10
45519	3 mm x 15 m	10



NETKANO TEKSTILNO SJENILO

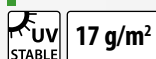

Broj	specifikacija	
45540	1,6 x 5 m	40
45541	1,6 x 10 m	40
45542	1,6 x 50 m	u ulozu 1
45543	1,6 x 100 m	u ulozu 1



NETKANO TEKSTILNO SJENILO



Broj	specifikacija	
45550	1,6 x 5 m	50
45551	1,6 x 10 m	20
45564	3,2 x 10 m	20
45552	1,6 x 50 m	u ulozu 1
45553	1,6 x 100 m	u ulozu 1
45562	3,2 x 50 m	u ulozu 1
45563	3,2 x 100 m	u ulozu 1



NETKANO TEKSTILNO SJENILO



Broj	specifikacija	
45556	1,6 x 5 m	50
45557	1,6 x 10 m	20
45565	3,2 x 10 m	20
45558	1,6 x 50 m	u ulozu 1
45559	1,6 x 100 m	u ulozu 1

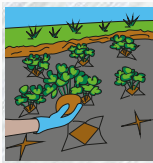

VEZANA TKANINA S ODJELJCIMA ZA BILJKE

uv
STABLE 45 g/m²

Broj	specifikacija	
45535	1,6 x 5 m	18



KOLČIĆ ZA UČVRŠĆIVANJE TEKSTILNOG SJENILA

10x

Broj	specifikacija	
45555	11,5 cm	1



MREŽA ZA KRASTAVCE

Broj	specifikacija	eye size	
45560	2 x 10 m	10 x 10 cm	100

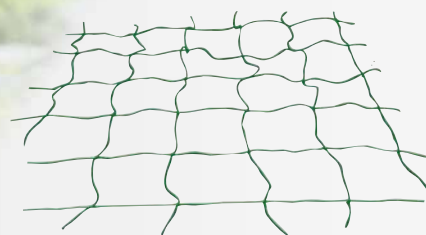

KOLČIĆ ZA RAJČICU FIBERGLAS

Broj	specifikacija	
45036	180 cm Ø 7,9 mm	100

TRAKE ZA VEZANJE

50x

Broj	specifikacija	
23840		20



KOLČIĆ ZA RAJČICU FIBERGLAS

Broj	specifikacija		Broj	specifikacija		Broj	specifikacija	
45650	90 cm Ø 8 mm	25	45655	150 cm Ø 11 mm	25	45659	180 cm Ø 16 mm	25
45651	120 cm Ø 8 mm	25	45656	180 cm Ø 11 mm	25	45660	210 cm Ø 16 mm	25
45652	150 cm Ø 8 mm	25	45661	210 cm Ø 11 mm	25	45662	150 cm Ø 20 mm	10
45653	90 cm Ø 11 mm	25	45657	120 cm Ø 16 mm	25	45663	180 cm Ø 20 mm	10
45654	120 cm Ø 11 mm	25	45658	150 cm Ø 16 mm	25	45664	210 cm Ø 20 mm	10



SPIRALNI KOLČIĆ ZA RAJČICU

Broj	specifikacija	
44041	1,2 m, Ø 5,5 mm komaxit - zelen	10
44042	1,5 m, Ø 6 mm komaxit - zelen	10
44043	1,8 m, Ø 6 mm komaxit - zelen	10
45049	1,8 m, Ø 7 mm komaxit - zelen	10
45044	1,8 m, Ø 7 mm komaxit - srebro	10
44050	2,2 m, Ø 7 mm komaxit - zelen	10

PLASTIČNA SPOJKA

Broj	specifikacija	
45670	8 mm	10
45671	11 mm	10
45672	16 mm	10
45673	20 mm	10



MOQ
10



TRAKA ZA VEZANJE,
ČIČAK

Broj	specifikacija	
45471	12 mm x 5 m	1



ŽICA ZA VEZANJE

Broj	specifikacija	
45043	30 m	30

ŽICA ZA VEZANJE
OBLOŽENA
GUMOM

Broj	specifikacija	
23845	3 mm x 8 m	30
23846	4 mm x 6 m	30
23847	5 mm x 4 m	30



TRAKE ZA VEZANJE

Broj	specifikacija	
45472	3 cm x 3 m, 3 kom	36



TRAKE ZA VEZANJE

Broj	specifikacija	
45473	3 cm x 50 m	60



PODLOŽAK

Broj	specifikacija	
45086	40 x 18 x 2 cm	50



VRTNA STOLICA, SKLOPIVA

za sjedenje i klečanje

Broj	specifikacija	
45074	58 x 48 x 28 cm	4



SKLOPIVA KOŠARA

Broj	specifikacija	
45093	40 x 25 x 23 cm	10



PLASTIČNA KANTA

MADE IN EU

Broj	specifikacija	
39192	26 l	20
39193	42 l	20



SKLOPIVI KOŠ ZA LIŠĆE

Broj	specifikacija	
45047	55 x 70 cm, 3 ručke	20



SKLOPIVI KOŠ ZA LIŠĆE

Broj	specifikacija	
44960	200 l 60 x 60 x 55 cm	50



FESTA[®]
AQUATIC

FESTA[®]
AQUATIC
PIŠTOLJ



- 7 funkcija
- okidač sa bravicom
- regulacija protoka vode



Broj	specifikacija	
45386		12

FESTA[®]
AQUATIC
PIŠTOLJ



- regulacija mlaza
- okidač sa bravicom
- regulacija protoka vode



Broj	specifikacija	
45388		12

FESTA[®]
AQUATIC
MLAZNICA



- regulacija mlaza



Broj	specifikacija	
45389		24



FESTA[®]
AQUATIC
KOMPLET SA MLAZNICOM

- regulacija mlaza



Broj	specifikacija	
45385	4 kom	12



FESTA[®]
AQUATIC
SPOJNICA



Broj	specifikacija	
1/2"	45390	24

FESTA[®]
AQUATIC
BRZA SPOJNICA



Broj	specifikacija	
1/2"	45392	24

FESTA[®]
AQUATIC
STOP BRZA SPOJNICA



Broj	specifikacija	
1/2"	45394	24

FESTA[®]
AQUATIC
SPOJNICA

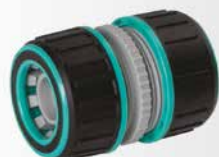

Broj	specifikacija	
3/4"	45391	24

FESTA[®]
AQUATIC
BRZA SPOJNICA



Broj	specifikacija	
3/4"	45393	24

FESTA[®]
AQUATIC
STOP BRZA SPOJNICA



Broj	specifikacija	
3/4"	45395	24

FESTA
AQUATIC
ADAPTER



Broj	specifikacija	
45396		24



NEW

FESTA
AQUATIC

VRTNO CRIJEVO
PROFI



Broj	specifikacija	
45372	1/2" 25 m	1
45373	1/2" 50 m	1
45374	3/4" 25 m	1
45375	3/4" 50 m	1
45376	1" 25 m	1
45377	1" 50 m	1



FESTA
AQUATIC
ADAPTER



Broj	specifikacija	
45397		24



FESTA
AQUATIC
RASPRŠIVAČ

· 19 mlaznica sa isključivanjem 8 mlaznica (prekidač on/off)



Broj	specifikacija	
45398		6

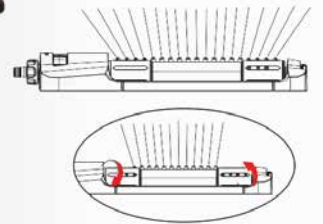

FESTA
AQUATIC
RASPRŠIVAČ

· podesivi raspršivač



Broj	specifikacija	
45399		12

FESTA
AQUATIC

RAČVA SA 2 ADAPTERA

· regulacija protoka vode



Broj	specifikacija	
45400		6



FESTA
AQUATIC

RAČVA SA 4
ADAPTERA

· regulacija protoka vode



Broj	specifikacija	
45401		6



ROSA PIŠTOLJ

- 10 funkcija
- prijedni okidač sa bravicom

0,7bar min
5,5bar max

Broj specifikacija

45124



12



ROSA PIŠTOLJ

- 10 funkcija
- okidač sa bravicom
- regulacija protoka vode

0,7bar min
5,5bar max

Broj specifikacija

45125



12



ROSA

Watering system



ROSA PIŠTOLJ

- 7 funkcija
- okidač sa bravicom

0,7bar min
5,5bar max

Broj specifikacija

45126



12

ROSA PIŠTOLJ

- 7 funkcija
- okidač sa bravicom
- regulacija protoka vode

0,7bar min
5,5bar max

Broj specifikacija

45123 metal



12



ROSA PIŠTOLJ

- 6 funkcija
- okidač sa bravicom
- regulacija protoka vode

0,7bar min
5,5bar max

Broj specifikacija

45117



12



ROSA PIŠTOLJ

- 6 funkcija
- okidač sa bravicom
- regulacija protoka vode

0,7bar min
5,5bar max

Broj specifikacija

45118 metalna glava



12



ROSA PIŠTOLJ

- 5 funkcija
- okidač sa bravicom
- regulacija protoka vode

0,7bar min
5,5bar max

Broj specifikacija

45110



12



ROSA PIŠTOLJ

- efekt rose
- regulacija protoka vode

0,7bar min
5,5bar max

Broj specifikacija

45116



12



ROSA
PIŠTOLJ

- metalna glava
- okidač sa bravicom
- regulacija protoka vode

0,7 bar min
5,5 bar max

Broj specifikacija 12  



ROSA
PIŠTOLJ

- metal
- okidač sa bravicom
- regulacija protoka vode

0,7 bar min
5,5 bar max

Broj specifikacija 12  



ROSA
PIŠTOLJ

- okidač sa bravicom
- regulacija protoka vode

0,7 bar min
5,5 bar max

Broj specifikacija 12  



ROSA
MLAZNICA

- prilagodljiv mlaz

10 bar max
1"



Broj specifikacija 48  



ROSA
MLAZNICA

- za klasičnu spojnicu

0,7 bar min
5,5 bar max

Broj specifikacija 32  



ROSA
MLAZNICA

- prilagodljiv mlaz

0,7 bar min
5,5 bar max

Broj specifikacija 60  



ROSA
PIŠTOLJ

- okidač sa bravicom
- regulacija protoka vode

0,7 bar min
5,5 bar max

Broj specifikacija 12  



ROSA
KOMPLET SA PIŠTOLJEM

- okidač sa bravicom
- regulacija protoka vode

0,7 bar min
5,5 bar max
1/2" 2x

Broj specifikacija 12  



ROSA
**PIŠTOLJ
KOMPLET**

- 6 funkcija
- okidač sa bravicom
- regulacija protoka vode

0,7 bar min
5,5 bar max
1/2" 4x



Broj specifikacija 12  



ROSA
KOMPLET SA MLAZNICOM

- prilagodljiv mlaz

0,7 bar min
5,5 bar max
1/2" 4x

Broj specifikacija 12  



ROSA
SPOJNICA



Broj specifikacija **45140** 60

ROSA
BRZA SPOJNICA



Broj specifikacija **45142** 60

ROSA
STOP
BRZA SPOJNICA



Broj specifikacija **45138** 60

ROSA
SPOJNICA



MOQ 20

Broj specifikacija **45296** MOQ 20

ROSA
BRZA SPOJNICA



MOQ 20

Broj specifikacija **45298** MOQ 20

ROSA
STOP
BRZA SPOJNICA



MOQ 20

Broj specifikacija **45294** MOQ 20

ROSA
SPOJNICA



Broj specifikacija **45141** 60

ROSA
BRZA SPOJNICA



Broj specifikacija **45143** 60

ROSA
STOP
BRZA SPOJNICA



Broj specifikacija **45139** 60

ROSA
SPOJNICA



MOQ 20

Broj specifikacija **45297** MOQ 20

ROSA
BRZA SPOJNICA



MOQ 20

Broj specifikacija **45299** MOQ 20

ROSA
STOP
BRZA SPOJNICA



MOQ 20

Broj specifikacija **45295** MOQ 20

ROSA
REDUKCIJA 1/2" - 3/4"



Broj specifikacija **45213** 1/2" - 3/4" 60

ROSA
REDUKCIJA 3/4" - 1"



Broj specifikacija **45216** 3/4" - 1" 48

ROSA
SPOJNICA



Broj specifikacija **45218** 1" 48

ROSA
ADAPTER



Broj	specifikacija	
45130	1/2" + 3/4"	60
45131	3/4" + 1"	60

ROSA
ADAPTER



Broj	specifikacija	
45217	1"	48

ROSA
BRZA SPOJNICA



Broj	specifikacija	
45219	1"	48

ROSA
ADAPTER



Broj	specifikacija	
45289	1/2" + 3/4"	MOQ 20
45290	3/4" + 1"	MOQ 20

ROSA
BRZA SPOJNICA

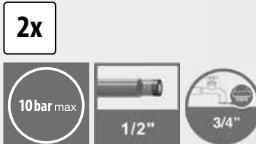

Broj	specifikacija	
45144	1/2"	60

ROSA
KONEKTOR



Broj	specifikacija	
45135	3/4"	60

ROSA
ADAPTER



Broj	specifikacija	
45133	3/4"	60

ROSA
ADAPTER



Broj	specifikacija	
45132	3/4"	60

ROSA
ADAPTER



Broj	specifikacija	
45136		60

ROSA
ADAPTER

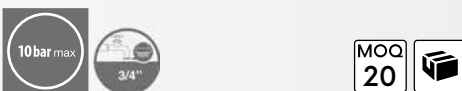

Broj	specifikacija	
45292	3/4"	MOQ 20

ROSA
ADAPTER

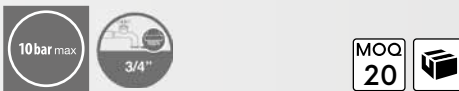

Broj	specifikacija	
45291	3/4"	MOQ 20

ROSA
ADAPTER



Broj	specifikacija	
45293		MOQ 20

ROSA
ADAPTER

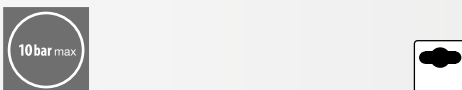

Broj	specifikacija	
45137		60

ROSA
ADAPTER

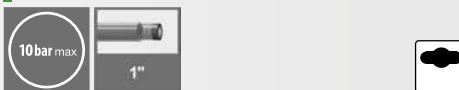

Broj	specifikacija	
45215	1"	48

ROSA
ADAPTER



Broj	specifikacija	
45145	1/2"	60

ROSA

RAČVA
SA 2 ADAPTERA

· sa ventilom

0,7 bar min
5,5 bar max

Broj specifikacija

45134



12



3/4"

ROSA

PRODAJNI SET

· sadrži

45113	15 szt.	kom
45117	10 szt.	kom
45120	15 szt.	kom
45132	40 szt.	kom
45131	40 szt.	kom
45133	40 szt.	kom
45142	25 szt.	kom
45143	20 szt.	kom
45140	20 szt.	kom

225x

Broj specifikacija

45146



1



ROSA

RASPRŠIVAČ
IMPULSNÍ

· impulse

0,7 bar min
5,5 bar max

Broj specifikacija

45162



24



ROSA

RASPRŠIVAČ

· 8 funkcija

0,7 bar min
5,5 bar max

Broj specifikacija

45154



48



ROSA

RASPRŠIVAČ

· rotacijski
· 2 mlazni0,7 bar min
5,5 bar max

Broj specifikacija

45153



24



ROSA

RASPRŠIVAČ

· rotacijski
· 3 mlazni0,7 bar min
5,5 bar max

Broj specifikacija

45152



24



ROSA

RASPRŠIVAČ

· aluminij

0,7 bar min
5,5 bar max

ALU

Broj specifikacija

45158



6

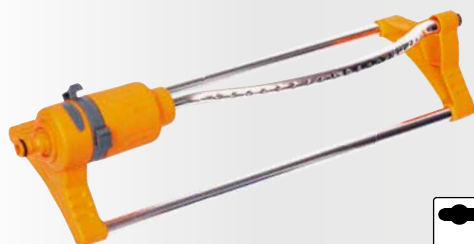

ROSA

RASPRŠIVAČ

· piramidalni

0,7 bar min
5,5 bar max

Broj specifikacija

45167



12



ROSA

STALAK
ZA IMPULSNE
RASPRŠIVAČE0,7 bar min
5,5 bar max

3/4"

Broj specifikacija

45155



24



ROSA

RASPRŠIVAČ

· tronožac

0,7 bar min
5,5 bar maxBroj specifikacija
45163 impulsni, tronožac

20



ROSA

RASPRŠIVAČ

· fikomni



Broj specifikacija 25

45160

ROSA

RASPRŠIVAČ

· fikomni sa ventilom



Broj specifikacija 12

45156

ROSA

TAJMER

· 0 - 120 min.



Broj specifikacija 24

45147

ROSA

RASPRŠIVAČ IMPULSNI, METALNI

· mesing



Broj specifikacija 12

45150

ROSA

RASPRŠIVAČ IMPULSNI PLASTIČNI



Broj specifikacija 12

45151

ROSA

RASPRŠIVAČ IMPULSNI



Broj specifikacija 12

45168

plastično sidrište

45169

metalno sidrište

ROSA

RASPRŠIVAČ UBODNI



Broj specifikacija 20

45161

plastično

ROSA

RASPRŠIVAČ UBODNI

· 3 kraka



Broj specifikacija 12

45164

plastično sidrište

ROSA

NASTAVAK ZA IMPULSNE RASPRŠIVAČE



Broj specifikacija 12

45159

ROSA

UBODNI T KOMAD



Broj specifikacija 12

45179

ROSA

DRŽAC ZA CRIJEVA

Broj specifikacija 48

45186



ROSA

RASPRŠIVAČ IMPULSNI



Broj specifikacija 20

45185

ROSA

RASPRŠIVAČ IMPULSNI



Broj specifikacija 20

45184

3/4"

ROSA

SPOJNICA

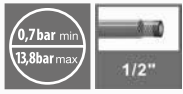

Broj specifikacija
45192 48

ROSA

BRZA SPOJNICA



Broj specifikacija
45194 48

ROSA

STOP BRZA SPOJNICA



Broj specifikacija
45190 48

ROSA

SPOJNICA

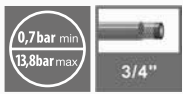

Broj specifikacija
45193 48

ROSA

BRZA SPOJNICA



Broj specifikacija
45195 48

ROSA

STOP BRZA SPOJNICA



Broj specifikacija
45191 48

ROSA

ADAPTER



Broj specifikacija
45196 sa unutarnjim navojem 1/2" + 3/4" 48

ROSA

ADAPTER



Broj specifikacija
45197 sa unutarnjim navojem 3/4" 48

ROSA

ADAPTER



Broj specifikacija
45199 sa unutarnjim navojem 1" 48

ROSA

ADAPTER



Broj specifikacija
45198 sa unutarnjim navojem 3/4" + 1" 48

ROSA

ADAPTER



Broj specifikacija
45200 sa vanjskim navojem 3/4" 48

ROSA

MLAZNICA



Broj specifikacija
45206 prilagodljiv mlaz 48

ROSA

ADAPTER



Broj specifikacija
45203 za 2 spojnice 48

ROSA

ADAPTER



Broj specifikacija
45204 za 3 spojnice 48

SPOJNICA SA NAVOJEM



Broj specifikacija
45211 1", navoj 1" 25

ROSA

KOMPLET BRTVI

· za artikle
45110, 45111, 45118, 45120, 45121, 45123,
45125, 45126, 45130, 45131, 45132, 45134,
45135, 45152, 45153, 45154, 45155, 45156,
45162, 45177, 45178, 45180, 45196, 45197,
45198



Broj specifikacija
45175 1

ROSA

BRTVA ZA ADAPTERE

50x

Broj specifikacija
45187 1



NEW



ROSA
VRTNO CRIJEVO



Broj	specifikacija	
45342	1/2" 10 m	1
45343	1/2" 15 m	1
45344	1/2" 20 m	1
45345	1/2" 25 m	1
45346	1/2" 50 m	1
45341	3/4" 10 m	1
45347	3/4" 15 m	1
45348	3/4" 20 m	1
45349	3/4" 25 m	1
45351	3/4" 50 m	1
45352	1" 15 m	1
45353	1" 25 m	1
45354	1" 50 m	1

NEW



FESTA
AQUATIC
VRTNO CRIJEVO
PROFI



Broj	specifikacija	
45372	1/2" 25 m	1
45373	1/2" 50 m	1
45374	3/4" 25 m	1
45375	3/4" 50 m	1
45376	1" 25 m	1
45377	1" 50 m	1



ROSA
CRIJEVO KOMPLET



Broj	specifikacija	
45300	7,5 m	6
45301	15 m	8



ROSA
RUČNI DRŽAČ CRIJEVA

Broj	specifikacija	
45178	1/2" 60 m	5



ROSA
KOLICA ZA CRIJEVO

Broj	specifikacija	
45183	1/2" 60 m	5



ROSA
KOLICA ZA CRIJEVO

Broj	specifikacija	
45177	1/2" 60 m	5



ROSA
DRŽAČ CRIJEVA

Broj	specifikacija	
45182	1/2" 40 m	4

ROSA
DRŽAČ CRIJEVA -
AUTOMATSKO
NAMOTAVANJE

· sa crijevom 1/2" 20 m



Broj	specifikacija	
45176		1



ROSA
DRŽAČ CRIJEVA

Broj	specifikacija	
45174		60



REMEN ZA CRIJEVO

· maksimalni namotaj 1/2" vrtnog crijeva do 30 m

Broj	specifikacija	
45350	maksimalni nosivost 20 kg	1

SPOJNICA CRIJEVA

Broj	specifikacija	
45220	1/2" navoj 3/4"	10
45221	3/4" navoj 1"	10
45222	1" navoj 1"	10



NASTAVAK CRIJEVA

Broj	specifikacija	
45223	1/2" navoj 3/4"	10
45224	3/4" navoj 1"	10
45225	1" navoj 1"	10



REDUKCIJA CRIJEVA

Broj	specifikacija	
45226	1/2" - 3/4" navoj 1"	10
45227	1" - 3/4" navoj 1"	10
45228	1" - 1/2" navoj 1"	10



RASPRŠIVAČ

Broj	specifikacija	
45229		10



Broj	průměr	
45603	16 - 25 mm	2
45604	20 - 32 mm	2
45605	25 - 40 mm	2
45606	30 - 45 mm	2
45607	32 - 50 mm	2
45608	40 - 60 mm	2
45609	50 - 70 mm	2
45610	60 - 80 mm	2
45611	70 - 90 mm	2
45612	80 - 100 mm	2
45613	90 - 110 mm	2
45614	100 - 120 mm	2
45615	110 - 130 mm	2
45616	120 - 140 mm	2
45617	130 - 150 mm	2
45618	140 - 160 mm	2
45619	150 - 170 mm	2



Broj	průměr	šířina	
45623	16 - 25 mm	9 mm	2
45624	20 - 32 mm	9 mm	2
45625	25 - 40 mm	12 mm	2
45626	30 - 45 mm	12 mm	2
45627	32 - 50 mm	12 mm	2
45628	40 - 60 mm	12 mm	2
45629	50 - 70 mm	12 mm	2
45630	60 - 80 mm	12 mm	2
45631	70 - 90 mm	12 mm	2
45632	80 - 100 mm	12 mm	2
45633	90 - 110 mm	12 mm	2
45634	100 - 120 mm	12 mm	2
45635	110 - 130 mm	12 mm	2
45636	120 - 140 mm	12 mm	2
45637	130 - 150 mm	12 mm	2
45638	140 - 160 mm	12 mm	2
45639	150 - 170 mm	12 mm	2

OBUJMIČA (ŠELNA)
ČELIČNA

Zn MOQ 2

Broj	průměr	
45600	8 - 12 mm	2
45601	10 - 16 mm	2
45602	12 - 20 mm	2

OBUJMIČA ČELIČNA
ROST FREI

INOX MOQ 2

Broj	průměr	šířina	
45620	8 - 12 mm	9 mm	2
45621	10 - 16 mm	9 mm	2
45622	12 - 20 mm	9 mm	2

VRTNI VENTIL

Broj	
45105	8



VRTNI VENTIL

Broj	specifikacija	
45100	1/2"	12
45101	3/4"	10
45102	1"	6



KUGLIČNI VENTIL

Broj	specifikacija	
45106	1/2"	12
45107	3/4"	10
45108	1"	8

KANTA
ZA VODUMADE IN
EU

Broj	specifikacija	
45280	2,5 l	10
45283	5 l	10
45285	10 l	10
45286	12 l	10
45287	15 l	10



KUTNI VENTIL

Broj	specifikacija	
45104	1/2" x 3/8"	10



**FESTA****TLAČNA PRSKALICA**

makom. pritisak	2,5 Bar
volumen:	12 l
dužina crijeva	3 m
dimenzije:	32 x 25 x 59 cm



Broj	specifikacija	
45249	tlačna prskalica 12 l	1

FESTA**TLAČNA PRSKALICA**

Broj	specifikacija	
45247	12 l	1
45248	16 l	1



Broj	specifikacija	
45263	rezervno crijevo za prskalicu	1
45251	rezervni set brtva	1
45254	rezervna mlaznica	1
45257	rezervna drška	1
45261	rezervni motka - 370 mm	1
45267	rezervni motka 45 - 250 cm	1
45268	rezervni motka 65 - 260 cm	1

FESTA**TLAČNA PRSKALICA**

Broj	specifikacija	
45244	3 l	6
45245	5 l	6
45246	8 l	6



Broj	specifikacija	
45262	rezervno crijevo za prskalicu	1
45250	rezervni set brtva	1
45253	rezervna mlaznica	1
45256	rezervna drška	1
45260	rezervni motka - 370 mm	1

* pogodan za : 45244, 45245, 45246



* pogodan za : 45247, 45248

93 - 250 cm

**TELESKOPSKI ŠTAP ZA PRSKANJE**

Broj	typ	
45267	45 - 250 cm	inox 1
45268	65 - 260 cm	fiberglass 1

TELESKOPSKI ŠTAP ZA PRSKANJE

Broj	specifikacija	
45269		1

**REZERVNO CRIJEVO ZA PRSKALICU**

Broj	typ	
45263	pogodan za 45247, 45248	1
45262	pogodan za 45244, 45245, 45246	1

**ZVONO ZA PRSKALICU**

Broj	velikost	dužina	širina	visina	
45265	mali	230 mm	90 mm	130 mm	1
45266	veliki	370 mm	140 mm	200 mm	1



FESTA

TLAČNA
RUČNA
PRSKALICA



Broj	typ	
45242	1,5 l	20
45241	2 l	20

TLAČNA RUČNA PRSKALICA



Broj	typ	
45239	0,5 l	1
45240	0,7 l	1



ROSA

VRTNI TUŠ



Broj	specifikacija	
45171	prilagodljiv	12

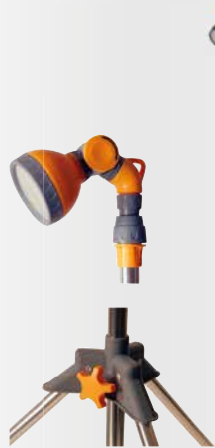

ROSA

VRTNI TUŠ



Broj	specifikacija	
45170	tronožac	6



ROSA

VRTNI TUŠ
PRODUŽENI



Broj	specifikacija	
45172	sa ventilom	12
45173	10 funkcija	12



FESTA[®]

system click
ON - OFF

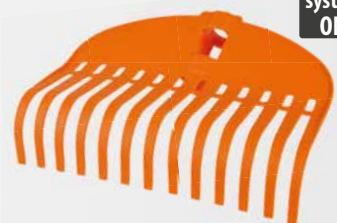

system click
ON - OFF



system click
ON - OFF

FESTA

GRABLJE PVC

Broj	broj lamele	širina	visina	
45327	13	240 mm	200 mm	12

FESTA

GRABLJE PVC

Broj	broj lamele	širina	
45325	12	410 mm	12



system click
ON - OFF



system click
ON - OFF

FESTA

GRABLJE PVC

Broj	broj lamele	širina	visina	
45328	23	480 mm	280 mm	12

FESTA

GRABLJE PVC

Broj	broj lamele	širina	
45326	18	580 mm	12



system click
ON - OFF



system click
ON - OFF

FESTA

GRABLJE PVC

Broj	broj lamele	širina	visina	
45329	35	760 mm	310 mm	1

FESTA

METLA

Broj	specifikacija	
45323	37 cm	16

FESTA

DRŽALO ALU

ALU



system click
ON - OFF

Broj	specifikacija	
45330	161 cm	24
45331	100 cm	24

**FESTA**

GRABLJE METALNE PODESIVE



Zn

Broj	broj lamele	rozsah	
44965	15	200 - 590 mm	12

GRABLJE METALNE PODESIVE



Zn

Broj	broj lamele	váha	rozsah	
45050	15	1200 g	200 - 590 mm	25

FESTA

GRABLJE METALNE - LAMELE

· opružni čelik

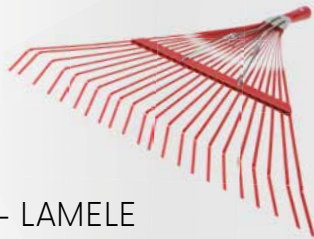

Broj	širina	broj lamele	
45071	55 cm	22	1

FESTA

GRABLJE METALNE LAMELE S DRŽALOM

MOQ
3

Broj	širina	duljina ručke	
61150	55 cm	160 cm	3



GRABLJE METALNE LAMELE S DRŽALOM

MOQ
3

Broj	širina	duljina ručke	
61130	40 cm	160 cm	3

GRABLJE METALNE - LAMELE

Broj	širina	broj lamele	
45051	40 cm	22	60



GRABLJE METALNE S DRŽALOM

MOQ
3

Broj	širina	duljina ručke	
61131	45 cm	160 cm	3

GRABLJE METALNE - ŽICA

Broj	širina	broj lamele	
45052	45 cm	22	36

GRABLJE PVC



Broj	širina	broj lamele	
45320	60 cm	24	10

GRABLJE PVC S DRŽALOM



Broj	širina	broj lamele	duljina ručke	
61132	60 cm	24	160 cm	3

MOQ
3

GRABLJE PVC



Broj	širina	broj lamele	
45055	50 cm	22	10

GRABLJE PVC S DRŽALOM



Broj	širina	broj lamele	duljina ručke	
61133	50 cm	22	160 cm	3

MOQ
3

GRABLJE PVC



Broj	širina	broj lamele	
45321	40 cm	23	20

GRABLJE PVC S DRŽALOM



Broj	širina	broj lamele	duljina ručke	
61134	40 cm	23	160 cm	3

MOQ
3

GRABLJE PVC



Broj	širina	broj lamele	
45054	40 cm	23	10

GRABLJE PVC S DRŽALOM



Broj	širina	broj lamele	duljina ručke	
61135	40 cm	23	160 cm	3

MOQ
3

GRABLJE PVC



Broj	širina	broj lamele	
45053	58 cm	16	35

GRABLJE PVC S DRŽALOM



Broj	širina	broj lamele	duljina ručke	
61141	58 cm	16	160 cm	3

MOQ
3

GRABLJE PVC S RUBOM ZA RAVNANJE



Broj	širina	broj zuba	
45070	41 cm	14	4

GRABLJE PVC S RUBOM ZA RAVNANJE I DRŽALOM



MOQ
3

Broj	širina	broj zuba	duljina ručke	
61142	41 cm	14	160 cm	3

GRABLJE METALNE

Broj	širina	broj zuba	
61030	24 cm	10	24
61031	29 cm	12	24
61032	34 cm	14	24
61033	40 cm	16	24



GRABLJE METALNE S DRŽALOM

Broj	širina	broj zuba	duljina ručke	
61060	24 cm	10	160 cm	3
61061	29 cm	12	160 cm	3
61062	34 cm	14	160 cm	3
61063	40 cm	16	160 cm	3



MOQ
3

GRABLJE ZA PLJEVLJENJE

• efekt-lak (hammertone) boja

Broj	širina	broj zuba	
61045	30 cm	12	25
61046	39 cm	14	25
61047	45 cm	16	25



GRABLJE ZA PLJEVLJENJE S DRŠKOM

• efekt-lak (hammertone) boja

Broj	širina	broj zuba	duljina ručke	
61143	30 cm	12	160 cm	3
61144	39 cm	14	160 cm	3
61145	45 cm	16	160 cm	3



MOQ
3

GRABLJE ZA PLJEVLJENJE

Broj	širina	broj zuba	
61048	35 cm	11 21	12



GRABLJE ZA PLJEVLJENJE S DRŽALOM

Broj	širina	broj zuba	duljina ručke	
61146	35 cm	11 21	160 cm	3



MOQ
3

GRABLJE METALNE S DRŽALOM FIBERGLAS

Broj	širina	broj zuba	duljina ručke	
61034	34 cm	14	160 cm	3



MOQ
3



FESTAŠTIHAČA
ŠILJASTA

Broj	specifikacija	duljina ručke	
61006	19 x 28 cm	120 cm	5

**FESTA**ŠTIHAČA
MALA
ŠILJASTA

· pogodno za rad u stakleniku

Broj	specifikacija	duljina ručke	
61008	19 x 28 cm	85 cm	5

**FESTA**ŠTIHAČA
OBLA

Broj	specifikacija	duljina ručke	
61005	20 x 29 cm	120 cm	5

**FESTA****FESTA**ŠTIHAČA OBLA
PRODUŽENA

· za osobe više od 180 cm

Broj	specifikacija	duljina ručke	
61157	20 x 29 cm	130 cm	5

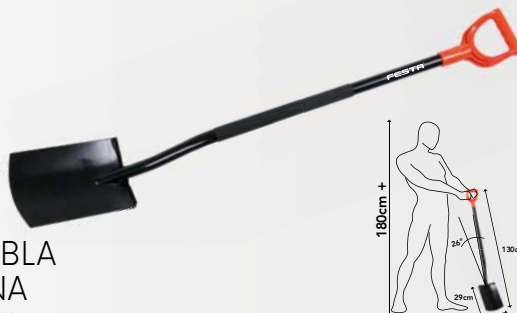
**FESTA**ŠTIHAČA ŠILJASTA,
PRODUŽENA

· za osobe više od 180 cm

Broj	specifikacija	duljina ručke	
61158	19 x 28 cm	130 cm	5

**FESTA**LOPATA
STANDARD

Č.p.	specifikace	duljina ručke	
61155	24 x 29 cm	120 cm	5

**FESTA**

VILE

Č.p.	specifikace	duljina ručke	
61156	19 x 28 cm	130 cm	5

**FESTA**VILE
ŽELJEZNO
DRŽALO

Broj	specifikacija	duljina ručke	
61007	18 x 28 cm	130 cm	5

VILE
DRŽALO
FIBERGLAS

Broj	specifikacija	duljina ručke	
61010	18 x 30 cm	95 cm	12

ŠTIHAČA ŠILJASTA
DRŽALO
FIBERGLAS

Broj	specifikacija	duljina ručke	
61029	19 x 30 cm	105 cm	12

ŠTIHAČA
DRŽALO
FIBERGLAS

Broj	specifikacija	duljina ručke	
61015	19 x 30 cm	105 cm	12





LOPATA ALU S DRŽALOM

· bukova ručka

Broj	specifikacija	duljina ručke	MOQ 3
61057	26 x 29 cm	130 cm	3
61056	34 x 30 cm	130 cm	3



LOPATA ALU

Broj	specifikacija	MOQ 3
61026	26 x 29 cm	10
61025	34 x 30 cm	10



LOPATA RAVNA S DRŽALOM

Broj	specifikacija	duljina ručke	MOQ 3
61089	35 x 35 cm	130 cm	3



LOPATA RAVNA

Broj	specifikacija	MOQ 3
61021	35 x 35 cm	10



LOPATA OBLA S DRŽALOM

· efekt-lak (hammertone) boja
· bukova ručka

Broj	specifikacija	duljina ručke	MOQ 3
61050	26 x 28 cm	130 cm	3



LOPATA OBLA

· efekt-lak (hammertone) boja

Broj	specifikacija	MOQ 3
61000	26 x 28 cm	12



LOPATA OVALNA S DRŽALOM

· bukova ručka

Broj	specifikacija	duljina ručke	MOQ 3
61088	26 x 28 cm	130 cm	3



LOPATA OVALNA

Broj	specifikacija	MOQ 3
61020	26 x 28 cm	12



LOPATA STANDARD S DRŽALOM

· efekt-lak (hammertone) boja
· bukova ručka

Broj	specifikacija	duljina ručke	MOQ 3
61051	24 x 29 cm	130 cm	3



LOPATA STANDARD

· efekt-lak (hammertone) boja

Broj	specifikacija	MOQ 3
61001	24 x 29 cm	12





LOPATA STANDARD

Broj	specifikacija	
61022	24 x 29 cm	12



LOPATA STANDARD S DRŽALOM

• bukova ručka

MOQ
3

Broj	specifikacija	duljina ručke	
61090	24 x 29 cm	130 cm	3
61053	24 x 29 cm	130 cm "T" ručka	3



LOPATA HOLSTEIN

Broj	specifikacija	
61058	25 x 27 cm	12



LOPATA HOLSTEIN S DRŽALOM

• bukova ručka

MOQ
3

Broj	specifikacija	duljina ručke	
61059	25 x 27 cm	130 cm	3



LOPATA USKA

• efekt-lak (hammertone) boja

Broj	specifikacija	
61002	19 x 27 cm	12



LOPATA USKA S DRŽALOM

• efekt-lak (hammertone) boja
• bukova ručka

MOQ
3

Broj	specifikacija	duljina ručke	
61052	19 x 27 cm	130 cm	3



LOPATA USKA

Broj	specifikacija	
61024	19 x 27 cm	12



LOPATA USKA S DRŽALOM

MOQ
3

Broj	specifikacija	duljina ručke	
61054	19 x 27 cm	130 cm	3



LOPATA PLASTIČNA

Broj	specifikacija	
61027	24 x 26 cm	12



ŠTIHACA ŠILJASTA S "T" DRŽALOM

· efekt-lak (hammertone) boja

MOQ
3

Broj	specifikacija	duljina ručke	
61161	22 x 30 cm	90 cm	3



ŠTIHACA ŠILJASTA

· efekt-lak (hammertone) boja

Broj	specifikacija	
61004	22 x 30 cm	12



ŠTIHAĆA ŠILJASTA S "T" DRŽALOM

MOQ
3

Broj	specifikacija	duljina ručke	
61097	19 x 30 cm	90 cm	3



ŠTIHAĆA ŠILJASTA

Broj	specifikacija	
61019	22 x 30 cm	12



ŠTIHAĆA ŠILJASTA - KOVANA S "T" DRŽALOM

Broj	specifikacija	duljina ručke	MOQ
61162	22 x 25 cm	90 cm	3
61223	drška	90 cm	1

ŠTIHAĆA ŠILJASTA - KOVANA

Broj	specifikacija	
61013	22 x 25 cm	12



LOPATA SA "T" DRŽALOM

· efekt-lak (hammertone) boja

MOQ
3

Broj	specifikacija	duljina ručke	
61163	21 x 30 cm	90 cm	3



LOPATA

· efekt-lak (hammertone) boja

Broj	specifikacija	
61003	21 x 30 cm	12



LOPATA

Broj	specifikacija	
61018	21 x 30 cm	12



LOPATA SA "T,, DRŽALOM

MOQ
3

Broj	specifikacija	duljina ručke	
61098	21 x 30 cm	90 cm	3



ŠTIHAĆA ZA RUPE

Broj	specifikacija	
61014	14 x 37 cm	12



ŠTIHAĆA ZA RUPE S "T,, DRŽALOM

Broj	specifikacija	duljina ručke	MOQ	
61164	14 x 37 cm	90 cm	3	3
61203	drška	90 cm	1	1



VILE

Broj	specifikacija	
61009	20 x 32 cm	12



VILE S DRŽALOM

MOQ
3

Broj	specifikacija	duljina ručke	
61165	20 x 32 cm	90 cm	3



VILE KOVANE ZA ŠTIHANJE

Broj	specifikacija	
61012	22 x 30 cm	12



VILE KOVANE S "T,, DRŽALOM

Broj	specifikacija	duljina ručke	MOQ	
61166	22 x 30 cm	90 cm	3	3
61222	drška	90 cm	1	1



VILE

Broj	specifikacija	
61044	20 x 30 cm	12



VILE S "T,, DRŽALOM

Broj	specifikacija	duljina ručke	MOQ	
61028	20 x 30 cm	90 cm	3	3
61209	drška	90 cm	1	1



MOTIKA ŠPICASTA KOVANA S DRŽALOM

Broj	specifikacija	duljina ručke	MOQ	
61111	0,4 kg	120 cm	3	
61112	0,6 kg	120 cm	3	
61224	drška	120 cm	1	

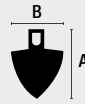

MOTIKA ŠPICASTA KOVANA

Broj	specifikacija	A	B	
61035	0,4 kg	180 mm	125 mm	1
61036	0,6 kg	230 mm	160 mm	30

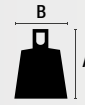

MOTIKA KOVANA PLOSNATA S DRŽALOM

Broj	specifikacija	duljina ručke	MOQ	
61114	0,6 kg	120 cm	3	
61224	drška	120 cm	1	



MOTIKA KOVANA PLOSNATA

Broj	specifikacija	A	B	
61038	0,6 kg	165 mm	135 mm	20

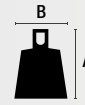

MOTIKA S DRŽALOM

MOQ
3

Broj	specifikacija	duljina ručke	
61290	75 mm	120 cm	3
61291	125 mm	120 cm	3
61292	175 mm	120 cm	3

MOTIKA

Broj	specifikacija	
61067	75 mm	1
61068	125 mm	1
61069	175 mm	1



MOTIKA OBLA S DRŽALOM

MOQ
3

Broj	specifikacija	duljina ručke	
61293	140 mm	120 cm	3

MOTIKA OBLA

Broj	specifikacija	
61070	140 mm	40



KRAMP KOVANI S DRŽALOM

MOQ
3

Broj	specifikacija	duljina ručke	
61121	1,5 kg	95 cm	3
61042	2,5 kg	95 cm	3

KRAMP KOVANI

Broj	specifikacija	
61120	1,5 kg	6
61040	2,5 kg	6



FESTA

LOPATE ZA SNIJEG



Broj	specifikacija	
60006	46 x 34 cm	12
60206	46 x 34 cm, nasadeno	1

FESTA

LOPATE ZA SNIJEG



Broj	specifikacija	
60008	50 x 34 cm	12
60208	50 x 34 cm, nasadeno	1

LOPATE ZA SNIJEG



MADE IN EU

Broj	specifikacija	
60001	48 x 40 cm	10
60201	48 x 40 cm, nasadeno	1

LOPATE ZA SNIJEG



ALU

Broj	specifikacija	
60012	50 x 38 cm	12
60212	50 x 38 cm, nasadeno	1



STRUGAC ZA LED S DRŽALOM

Broj	specifikacija		MOQ
60022	20 cm	3	3

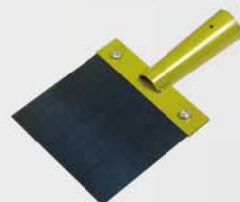

STRUGAC ZA LED

Broj	specifikacija	
60018	15 cm	20
60019	20 cm	24
60020	30 cm	20
61201	držka 130 cm	10



SOL ZA POSIPANJE

Broj	specifikacija	
43300	10 kg	1
43301	25 kg	1



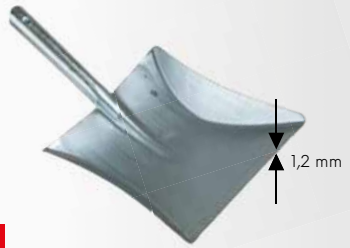

FESTA

LOPATICA

Broj	specifikacija	
52176	22 x 23 cm	24

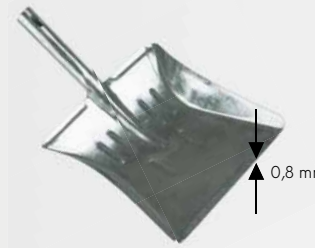

LOPATICA

Zn

Broj	specifikacija	
52175	22 x 23 cm	50



METLICA I LOPATICA

MADE IN EU

Broj	specifikacija	
52168		26



METLICA I LOPATICA

MADE IN EU

Broj	specifikacija	
52173		26



ČELIČNA ČETKA ZA ČIŠĆENJE SPOJEVA S RUČKOM

Broj	duljina ručke	
52198	140 cm	1



METLICA

MADE IN EU

Broj	specifikacija	
52119	29 cm	24



METLA S DRŽALOM

MADE IN EU

MOQ 3

Broj	specifikacija	
52197	30 cm 120 cm drven	3



METLA

MADE IN EU

Broj	specifikacija	
52108	30 cm sa navojem	25
61172	držalo 120 cm sa navojem	1



METLA S DRŽALOM

Broj	specifikacija	
52135	145 cm 5x prošiveno	1



system click ON - OFF

FESTA

METLA

Broj	specifikacija	
45323	37 cm	16



METLA



Broj	specifikacija	
52101	30 cm	10
52102	40 cm	10
52103	50 cm	10
52104	60 cm	10
52105	80 cm	10

METLA
S DRŽALOM

Broj	specifikacija	duljina ručke	
52190	30 cm	150 cm	3
52191	40 cm	150 cm	3
52192	50 cm	150 cm	3
52193	60 cm	150 cm	3
52194	80 cm	150 cm	3



METLA



Broj	specifikacija	
52160	40 cm	10
52161	50 cm	10
52162	60 cm	10
52163	70 cm	10
52164	80 cm	10

METLA
S DRŽALOM

Broj	specifikacija	duljina ručke	
52185	40 cm	150 cm	3
52186	50 cm	150 cm	3
52187	60 cm	150 cm	3
52188	70 cm	150 cm	3
52189	80 cm	150 cm	3



METLA



Broj	specifikacija	
52114	28 cm sa navojem	1

METLA
S DRŽALOM

Broj	specifikacija	duljina ručke	
52116	28 cm	130 cm	3



METLA



Broj	specifikacija	
52113	30 cm sa navojem	26
52115	30 cm bez navoju	26

METLA
S DRŽALOM

Broj	specifikacija	duljina ručke	
52195	30 cm	150 cm drven	3
52196	30 cm	130 cm ALU	3



POBIRAČ VODE



Broj	specifikacija	
15886	450 mm držalo Ø 23 mm	48
15887	600 mm držalo Ø 23 mm	48
15888	750 mm držalo Ø 23 mm	32

METLA
S DRŽALOM

Broj	specifikacija	duljina ručke	
52109	25 cm	120 cm drven	12





FESTA

ČELIČNA ČETKA

Broj	specifikacija		
22135	6 x 19 cm	bez držala	8
22137	6 x 19 cm	sa držalom 140 cm	MOQ 3



FESTA

NAJLONSKA ČETKA

Broj	specifikacija		
22136	6 x 19 cm	bez držala	8
22138	6 x 19 cm	sa držalom 140 cm	MOQ 3



MOP

Broj	specifikacija	
52110	30 cm	16



REZERVNI MOP

Broj	specifikacija	
52111	30 cm	1



FESTA

DRŽALO ALU

ALU

Broj	specifikacija	
45330	161 cm	24
45331	100 cm	24



DRŽALO ZA ČETKU

MADE IN EU

Broj	specifikacija	
61172	120 cm drveno držalo, navoj	1
61192	150 cm drveno držalo	za 52195 1
61193	150 cm drveno držalo	za 52185 - 94 1
61194	140 cm drveno držalo, navoj	1

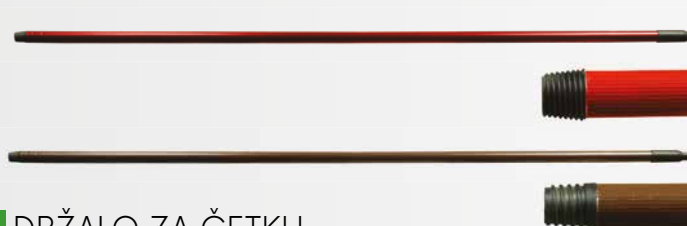

DRŽALO ZA ČETKU

ALU MADE IN EU

Broj	specifikacija	
52126	130 cm, navoj	1



DRŽALO ZA VILE I LOPATU

CZ

Broj	specifikacija	
61200	130 cm	10



DRŽALO ZA ČETKU

MADE IN EU

Broj	specifikacija		Broj	specifikacija	
61171	1,2 m	1	61175	1,6 m	1
61173	1,4 m	1	61176	1,7 m	1
61174	1,5 m	1	61177	1,8 m	1



DRŽALO ZA LOPATU "T,"

CZ

Broj	specifikacija	
61208	90 cm	10

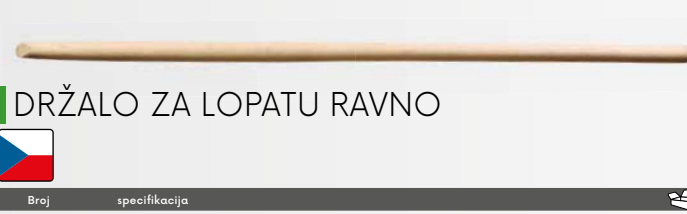

DRŽALO ZA LOPATU RAVNO

CZ

Broj	specifikacija	
61201	držalo 130 cm, ravno	10



DRŽALO ZA LOPATU "T,"

CZ

Broj	specifikacija	
61202	130 cm, ravno	10



DRŽALO ZA GRABLJE



Broj	specifikacija	
61215	160 cm	10



DRŽALO ZA KRAMP



Broj	specifikacija	
61204	95 cm, uski (pro 61120)	10
61205	95 cm	10



DRŽALO ZA PLASTIČNE GRABLJE



Broj	specifikacija	
61195	120 cm	10



DRŽALO ZA GRABLJE



Broj	specifikacija	za	
61250	160 cm	45051, 61048	20
61251	160 cm	45052	20
61252	160 cm	45320	20
61253	160 cm	45053	20
61254	160 cm	45054	20
61255	160 cm	45070	20
61256	160 cm	45055	20



DRŽALO ZA ŠTIHAČU, PLAST. RUKOHVAT „Y“



Broj	specifikacija	
61207	100 cm	10



DRŽALO ZA MOTIKU



Broj	specifikacija	
61219	120 cm	10



DRŽALO ZA ŽELJEZNE GRABLJE



Broj	specifikacija	
61183	150 cm	10
61184	160 cm	10
61189	170 cm	10
61190	180 cm	10



RUČKA PVC „Y„ ZA DRŽALO

Broj	specifikacija	
61230		10

61079



120 cm

80 cm

Broj	
61005	15
61006	15
61050	15
61051	15
61052	15
61079	1
61097	15
61098	15

61077



• ilustracijska fotografija

REKLAMNI STALAK

Broj	specifikacija	
61077	stalak s predmetima	1
61079	stalak s paletom	1



rotirajući gumeni valjci

DRŽAČ ZA VRTNI ALAT

5x

Broj	specifikacija	
51184		12



DRŽAČ ZA VRTNI ALAT

Broj	specifikacija	
51185	45 cm	15

• ilustracijska fotografija



MREŽICA PROTIV KUKACA

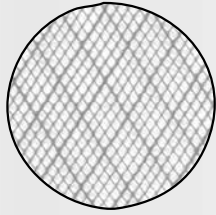

Broj	specifikacija	
40100	1 x 25 m - PE bijela	1
40120	1,2 x 25 m - PE bijela	1

MREŽICA PROTIV KUKACA

ALU **Zn**

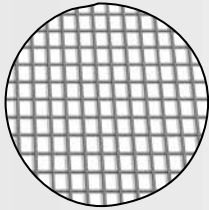

Broj	specifikacija	
42101	1 x 30 m - ALUMINIUM	2
42103	1 x 30 m - galvanizirana	2

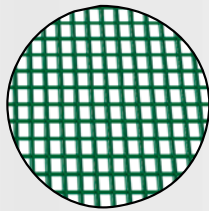

MREŽICA PROTIV KUKACA



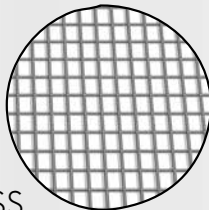

Broj	specifikacija	
42102	1 x 30 m - zelena-lakirana celicna mreža	2



MREŽICA PROTIV KUKACA - FIBERGLASS



Broj	specifikacija		
41083	0,8 x 30 m bijela	6	
41103	1 x 30 m bijela	6	
41123	1,2 x 30 m bijela	6	
41153	1,5 x 30 m bijela	6	

Broj	specifikacija		
41082	0,8 x 30 m bijela-siva	6	
41102	1 x 30 m bijela-siva	6	
41122	1,2 x 30 m bijela-siva	6	
41152	1,5 x 30 m bijela-siva	6	

Broj	specifikacija		
41050	0,5 x 30 m siva	6	
41080	0,8 x 30 m siva	6	
41100	1 x 30 m siva	6	
41120	1,2 x 30 m siva	6	
41150	1,5 x 30 m siva	6	

Broj	specifikacija		
41081	0,8 x 30 m crna	6	
41101	1 x 30 m crna	6	
41121	1,2 x 30 m crna	6	
41151	1,5 x 30 m crna	6	





KOMPLET MREŽA PROTIV KUKACA - BIJELA



Broj	specifikacija		
40050	150 x 130 cm	5,6 m	10
40052	150 x 180 cm	6,6 m	10
40054	150 x 90 cm	4,8 m	10
40056	220 x 75 cm 2 kom	5,8 m	10



KOMPLET MREŽA PROTIV KUKACA - SIVA



Broj	specifikacija		
40051	150 x 130 cm	5,6 m	10
40053	150 x 180 cm	6,6 m	10
40055	150 x 90 cm	4,8 m	10



KOMPLET MREŽA PROTIV KUKACA - CRNA



Broj	specifikacija		
40057	150 x 130 cm	5,6 m	10
40058	150 x 180 cm	6,6 m	10
40059	150 x 90 cm	4,8 m	10



ČIČAK TRAKA

Broj	specifikacija	
40060	9 mm 7 m	1



BLOKIRANJE SVJETLOSTI ZA VRATA PROTIV INSEKATA MAGNETNA - ANTRACIT



Broj	Specifikacija	
40077	100 x 220 cm	1



ZAVJESA ZA VRATA PROTIV KUKACA

· podesiva širina 60-120 cm

Broj	specifikacija		
40075	4 x 35 x 220 cm	bijela	20
40076	4 x 35 x 220 cm	crna	20

PLETIVO HEX

Zn



Broj	specifikacija	
42150	13 0,7 x 1000 mm - 50 m	1
42151	16 0,7 x 1000 mm - 50 m	1
42152	20 0,7 x 1000 mm - 50 m	1
42153	25 0,8 x 1000 mm - 50 m	1

PLETIVO HEX

Zn

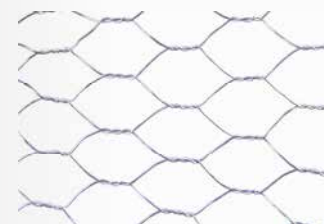

Broj	specifikacija	
42155	13 0,7 x 1000 mm - 50 m	1
42156	16 0,7 x 1000 mm - 50 m	1
42157	20 0,7 x 1000 mm - 50 m	1
42158	25 0,8 x 1000 mm - 50 m	1

PLETIVO HEX PLASTIFICIRANO

Zn



Broj	specifikacija	
42160	13 1 x 1000 mm - 25 m	1
42161	16 1 x 1000 mm - 25 m	1
42162	20 1 x 1000 mm - 25 m	1
42163	25 1 x 1000 mm - 25 m	1

UKRASNO PLETIVO PLASTIFICIRANO



Broj	eye size	Ø žice	visina	length	
42175	15 x 9 mm	2 mm	40 cm	25 m	1
42176	15 x 9 mm	2 mm	65 cm	25 m	1
42177	15 x 9 mm	2 mm	90 cm	25 m	1
42178	15 x 9 mm	2 mm	120 cm	25 m	1
42179	15 x 9 mm	2 mm	25 cm	25 m	1



PLETIVO ČETVRTASTO

140
g/m²

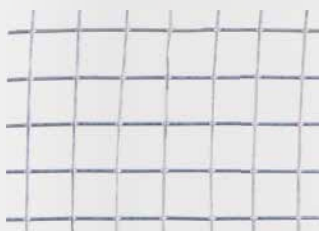

Broj	specifikacija		Broj	specifikacija	
42185	6 0,65 x 1000 mm - 25 m	1	42174	25 1,4 x 1000 mm - 25 m	1
42170	10 0,8 x 100 mm - 25 m	1	42186	13 1,05 x 1000 mm - 25 m	1
42171	13 0,8 x 1000 mm - 25 m	1	42187	25 2,0 x 1000 mm - 25 m	1
42172	16 1,2 x 1000 mm - 25 m	1	42188	50 2,0 x 1000 mm - 25 m	1
42173	19 1,4 x 1000 mm - 25 m	1			

PLETIVO ČETVRTASTO PLASTIFICIRANO

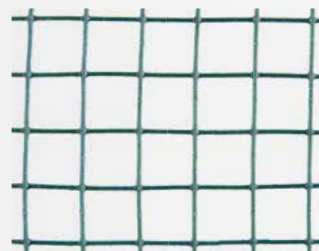

Broj	specifikacija	
42180	13 1,2 x 1000 mm - 25 m	1
42181	16 1,2 x 1000 mm - 25 m	1
42182	25 2,3 x 1000 mm - 25 m	1

MREŽA PROTIV PTICA

MADE IN
EU



Broj	specifikacija	
45570	2 x 5 m 18 x 18 mm	45
45571	2 x 10 m 18 x 18 mm	28
45572	4 x 5 m 18 x 18 mm	24
45573	4 x 10 m 18 x 18 mm	15

SIGURNOSNA OGRADA

140
g/m²

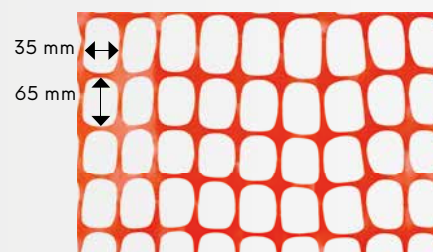

Broj	specifikacija	
42190	1,2 x 50 m HDPE 140g/m ²	1

PLETIVO RABIC

Zn



Broj	specifikacija	
42312	1 m 50 bm, 16 x 16 mm	1

ZAŠTITA STABLA OD DIVLJAČI

· samozatvarajuća



Broj	specifikacija	
45580	Ø 11 x 80 cm	1



ŽICA ZA VEZANJE

Zn

Broj	Ø žice	dužina žice	
42203	0,6 mm	30 m	50



ŽICA ZA VEZANJE

Broj	Ø žice	dužina žice	površina	
42201	0,6 mm	30 m	PVC	50
42202	0,9 mm	30 m	PVC	50



BODLJIKAVA ŽICA

Zn

Broj	Ø žice	dužina žice	
42260	1,7 mm	50 m	1
42261	1,7 mm	100 m	1

OPREMA
ZA NAPINJANJE

Broj	specifikacija	
50035	2 t	6
50036	4 t	4

ZATEZAC ŽIČANE OGRADE
MALI

Zn

Broj	specifikacija	
50030	mali, pocinčano	50
50032	mali presvučen pvc-om	50

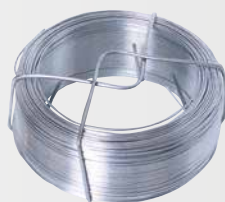

ŽICA ZA VEZANJE

Zn

Broj	Ø žice	dužina žice	
42207	0,8 mm	50 m	40
42208	0,8 mm	100 m	20
42209	0,9 mm	100 m	20
42240	1,0 mm	50 m	40
42210	1,0 mm	100 m	20
42211	1,2 mm	50 m	40
42212	1,2 mm	100 m	20
42213	1,4 mm	30 m	40
42214	1,4 mm	50 m	20
42217	1,8 mm	30 m	40
42218	1,8 mm	50 m	20



ŽICA ZA VEZANJE PLASTIFICIRANA

Broj	Ø žice	dužina žice	
42244	1,4 mm	50 m	20
42248	1,8 mm	50 m	20
42249	2,0 mm	50 m	20



ZATEZAC ŽICE

INOX

Broj	specifikacija	
50040	zelena	50
50041	crna	50

ZATEZAC ŽIČANE OGRADE
VELIKI

Zn

Broj	specifikacija	
50031	pocinčano	50
50033	presvučen pvc-om	50



ŽICA ZA VEZANJE

Zn

Broj	Ø žice	dužina žice	
42219	2,0 mm	26 m	20
42220	2,0 mm	52 m	20
42221	2,0 mm	78 m	20
42228	3,15 mm	26 m	10
42229	3,15 mm	52 m	10
42230	3,15 mm	78 m	10



ŽICA ZA VEZANJE PLASTIFICIRANA

Broj	Ø žice	dužina žice	
42251	2,6 mm	26 m	20
42252	2,6 mm	52 m	20
42253	2,6 mm	78 m	20
42255	3,4 mm	26 m	10
42256	3,4 mm	52 m	10
42257	3,4 mm	78 m	10



ZATEZAC ŽICE

10x

Broj	specifikacija	
50042		10

ZATEZAC ŽIČANE OGRADE
LT

Zn

Broj	specifikacija	
50037	ocynk	50
50038	PVC presvučen	50

NOSAČ STUPA

Zn

Broj	specifikacija	tl.	
55436	70 x 75 mm	110 mm	4 mm 10
55437	80 x 90 mm	130 mm	4 mm 10



NOSAČ STUPA

Zn

Broj	specifikacija	tl.	
55429	70 x 60 mm	100 mm	4 mm 10
55433	81 x 60 mm	100 mm	4 mm 10
55430	91 x 60 mm	100 mm	4 mm 10
55431	101 x 60 mm	100 mm	4 mm 10
55432	121 x 60 mm	100 mm	4 mm 10

NOSAČ STUPA
PODESIV

Zn

Broj	Specifikacija	tl.	
55465	80 - 160 x 70 mm	100 mm	4 mm 1

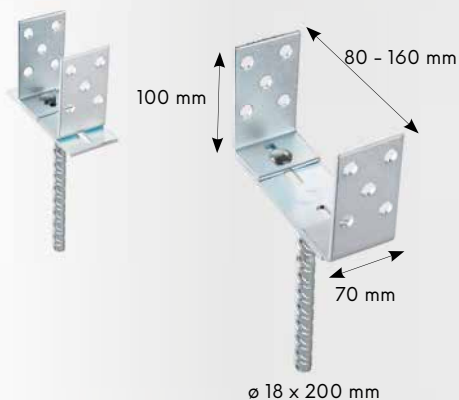

NOSAČ STUPA

Zn

Broj	Ø kotva	dužina kotva	debljina materijala	
55420	71 x 71 mm	150 mm	2 mm	1
55425	81 x 81 mm	150 mm	2 mm	1
55421	91 x 91 mm	150 mm	2 mm	1
55422	101 x 101 mm	150 mm	2 mm	1
55423	121 x 121 mm	150 mm	2 mm	1
55424	151 x 151 mm	150 mm	2 mm	1



SVRDLO ZA BUŠENJE ZEMLJE

Broj	Ø	A	B	
61299	110 mm	270 mm	1200 mm	1
61300	140 mm	270 mm	1200 mm	1
61301	170 mm	270 mm	1200 mm	1
61302	200 mm	270 mm	1200 mm	1

NOSAČ STUPA S VIJKOM

Zn

Broj	Ø kotva	visina kotva	navoj	
55460	80 x 80 mm	150 mm	M16	10
55461	100 x 100 mm	150 mm	M16	10
55462	150 x 150 mm	150 mm	M24	10

NOSAČ
STUPA

Zn

Broj	Ø kotva	dužina kotva	debljina materijala	
55400	71 x 71 mm	750 mm	2 mm	1
55401	91 x 91 mm	750 mm	2 mm	1
55406	81 x 81 mm	750 mm	2 mm	1
55402	91 x 91 mm	900 mm	2 mm	1
55403	101 x 101 mm	900 mm	2 mm	1
55404	121 x 121 mm	900 mm	2 mm	1
55405	151 x 151 mm	900 mm	2 mm	1

SIDRENI
VIJAK "U"

Zn

Broj	Ø kotva	dužina kotva	debljina materijala	
55455	71 x 60 mm	100 mm	4 mm	1
55452	81 x 60 mm	100 mm	4 mm	1
55456	90 x 60 mm	100 mm	4 mm	1
55453	101 x 60 mm	100 mm	4 mm	1
55457	110 x 60 mm	100 mm	4 mm	1
55454	121 x 60 mm	100 mm	4 mm	1

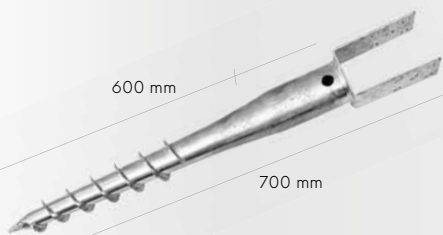
UNIVERZALNI SET
ZA PRICVRŠĆIVANJE

smanjenje

Ø 24 mm
Ø 35 mm
Ø 40 mm
Ø 48 mm
Ø 55 mm

Zn 6x

Broj	Ø kotva	dužina kotva	specifikacija	
55450	60 mm	550 mm	1 kom + 5x smanjenje	8

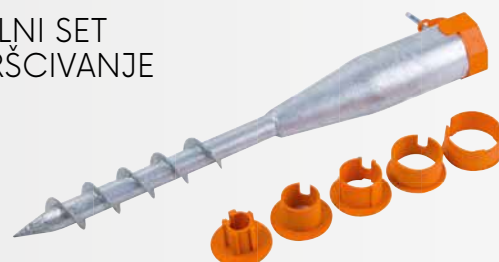

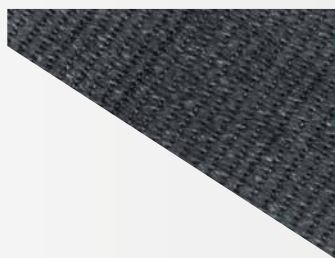

· blokiranje svjetlosti 85%

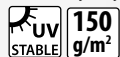

Broj	specifikacija	
45496	1 x 10 m	1
45497	1,5 x 10 m	1
45498	1,8 x 10 m	1
45499	2 x 10 m	1

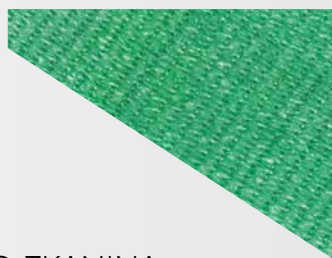

SJENILO TKANINA HDPE 150 G/ M²

· blokiranje svjetlosti 85%



Broj	specifikacija	
45460	1 x 10 m	1
45461	1,5 x 10 m	1
45463	1,8 x 10 m	1
45462	2 x 10 m	1



SJENILO TKANINA HDPE 220 G/ M²

· blokiranje svjetlosti 95%

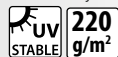

Broj	specifikacija	
45465	1 x 10 m	1
45466	1,5 x 10 m	1
45467	2 x 10 m	1



SJENILO TKANINA HDPE 80 G/ M²



Broj	specifikacija	
45450	1 x 10 m	1
45451	1,5 x 10 m	1
45453	1,8 x 10 m	1
45452	2 x 10 m	1

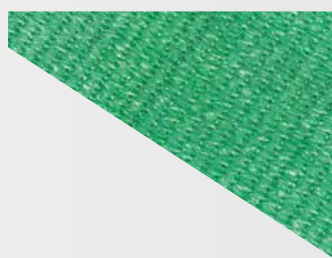

SJENILO TKANINA HDPE 150 G/ M²

· blokiranje svjetlosti 85%

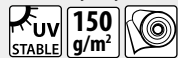

Broj	specifikacija	
45480	1,5 x 50 m	1



SJENILO TKANINA HDPE 220 G/ M²

· blokiranje svjetlosti 95%

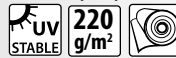

Broj	specifikacija	
45485	1,5 x 50 m	1



VEZICE

· EN 50146
· nylon



Broj	specifikacija	
23875	120 mm 4,8 mm	1



DRŽALO TKANINE ZA ZATAMNJENJE



Broj	specifikacija	
45470		1





GRILL KOMPLET

INOX 18x

Broj specifikacija

43077



6



GRILL KOMPLET

INOX 3x

Broj specifikacija

43071 380 mm



16



GILL HVATALJKA

INOX

Broj specifikacija

43072 360 mm



25



ALU TACNA

4x

Broj specifikacija

43050 300 x 200 mm

50

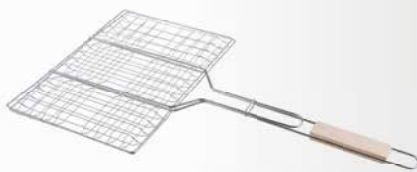

REŠETKA ZA PEČENJE

Broj specifikacija

43084 330 x 290 mm

50

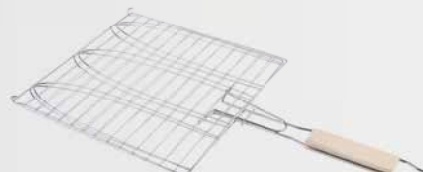

REŠETKA ZA PECENJE RIBE

Broj specifikacija

43082 280 x 276 mm

50

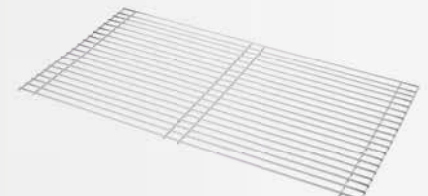

REŠETKE ZA ROŠTILJ

Broj specifikacija

43058 58 x 30 mm

20

43060 60 x 40 mm

20

43068 68 x 40 mm

16



REŠETKA ZA PECENJE RIBE

Broj specifikacija

43083 360 x 130 mm

12



ŠTAPIC ZA RAŽNJICE

4x

Broj specifikacija

43086 Ø 3 x 380 mm

80



VILICA ZA ROŠTILJ

* roštilju s higijenskim atestom

Broj specifikacija

43097 100 cm

100



285 - 900 mm

VILICA ZA ROŠTILJ - TELESKOPSKA

INOX



Č.p.	Specifikace
43094	

1



MIJEH MEHANIČKI



Broj	specifikacija
43087	

1



ČETKA ZA ROŠTILJ 2 IN 1

Broj	specifikacija
43098	30 cm

10



ČETKA ZA ROŠTILJ 3 IN 1

Broj	specifikacija
43099	

40



MOTOR ZA ROŠTILJ 230 V

CE



Broj	specifikacija
43090	do 10kg mesa

24



MOTOR ZA ROŠTILJ



Broj	specifikacija
43089	

48



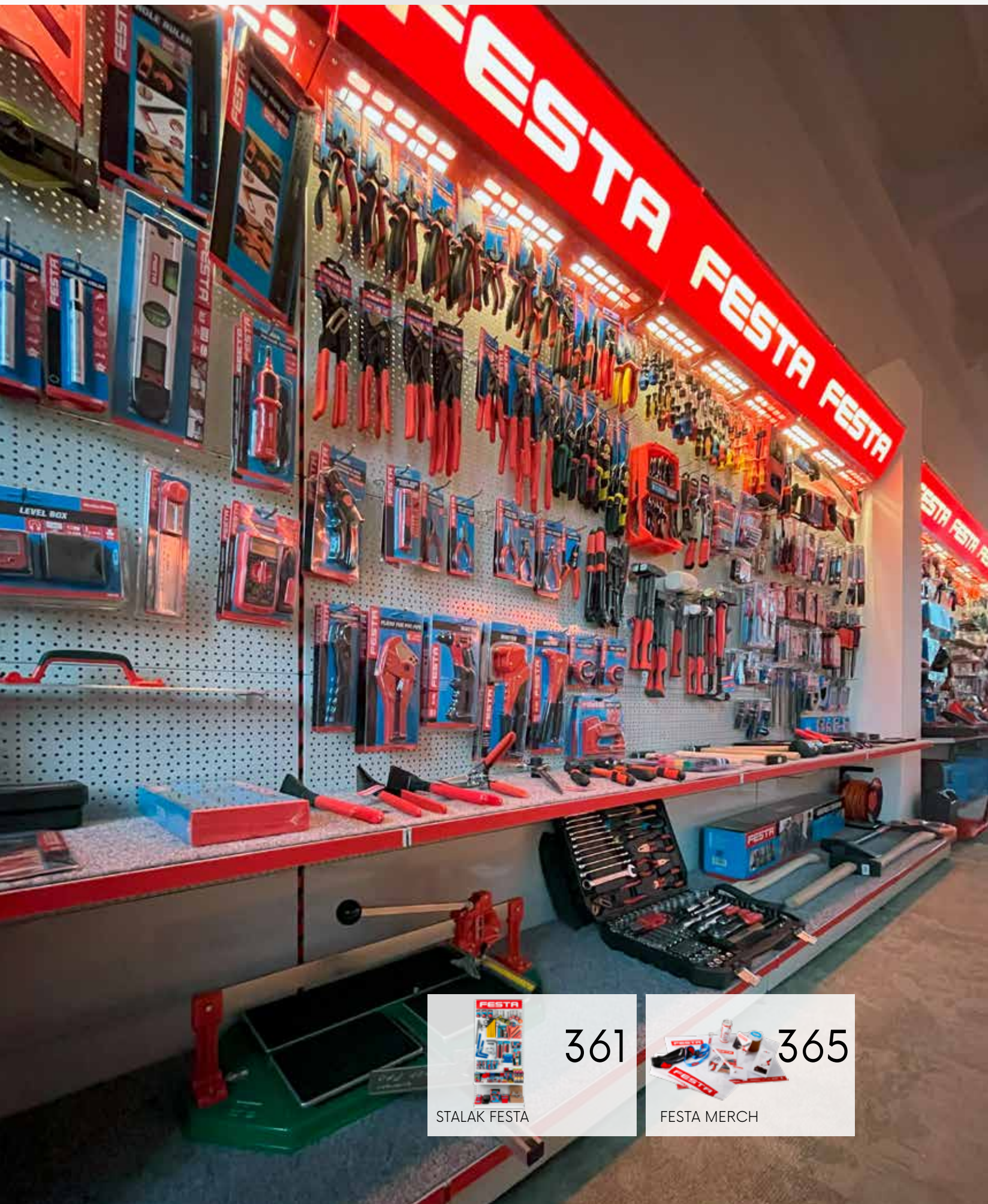

361

STALAK FESTA



365

FESTA MERCH



 STALAK FESTA ISPUNJEN STAVKAMA

FESTA

SVJETLOSNA KUTIJA ZA STALAK FESTA 81011

Broj	specifikacija	
81195	FESTA POWER TOOLS	1
81196	FESTA	1
81197	FESTA INDUSTRY	1



STALAK FESTA



Broj	specifikacija	
81011	stojak FESTA CZ 200 x 100 cm	1
81011A	stojak 81011 + nalejka AQUATIC	1
81011F	stojak 81011 + nalejka FESTA CZ	1
81011G	stojak 81011 + nalejka FESTA GB	1
81011H	stojak 81011 + nalejka FESTA SK	1
81011R	stojak 81011 + nalejka ROSA	1
81012	półka CZ CZ dubina 40 cm	8
81013	hak 10 cm	10
81014	hak 16 cm	10
81015	hak 20 cm	10
81035	hak 20 cm	10
81016	hak 30 cm	10
81036	hak 30 cm	10
81022	kosz z drutu - duży, 50 cm	1
81023	kosz z drutu - mały, 40 cm	1
81024	przegroda - duży, 50 cm	1
81025	przegroda - mały, 40 cm	1

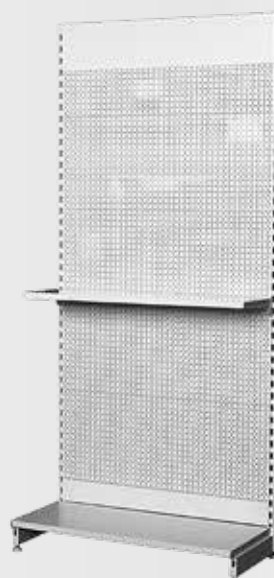

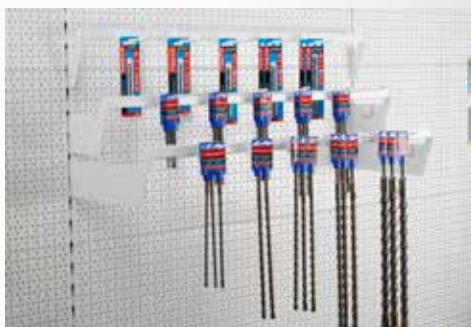

KONZOLA

kompatibilan s FESTA postoljem

Broj	specifikacija	
81150	1000 x 50 x 135 mm	1
81151	1000 x 150 x 135 mm	1
81152	1000 x 350 x 135 mm	1

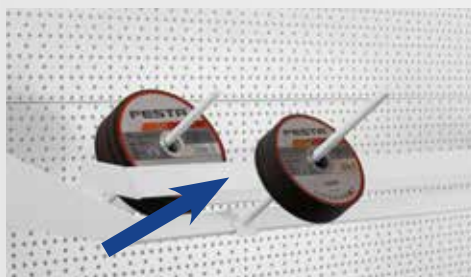

NOSITELJ CIJENA

kompatibilan s FESTA postoljem

Broj	specifikacija	
81155	1000 x 80 x 100 mm	1

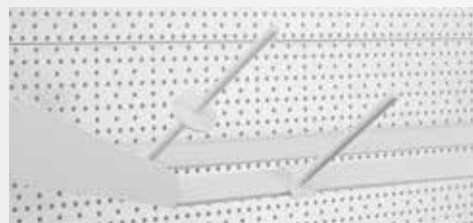

KUKA ZA DISK

kompatibilan s FESTA postoljem

Broj	specifikacija	
81186	150 mm	1
81185	250 mm	1



OKVIR ZA KUKU

kompatibilan s FESTA postoljem

Broj	specifikacija	
81170	1000 x 450 x 85 mm	1



DRŽAČ PILE

kompatibilan s FESTA postoljem

Broj	specifikacija	
81190		1



KUKA ZA AKUMULATORSKI ALAT

kompatibilan s FESTA postoljem

Broj	specifikacija	
81189		1



POLICA ZA DISKOVE

kompatibilan s FESTA postoljem

Broj	specifikacija	
81191	220 x 220 x 200 mm	1

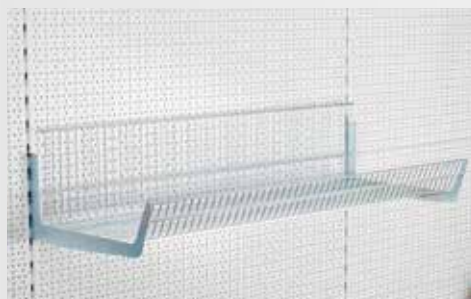

ŽIČANA KOŠARA

kompatibilan s FESTA postoljem

Broj	specifikacija	
81160	1000 x 470 x 180 mm	1



ODJELJAK

kompatibilan s FESTA postoljem

Broj	specifikacija	
81165	470 x 180 mm	1



DRŽAČ ČEKIĆA I MALJEVA

Zn

kompatibilan s FESTA postoljem

Broj	specifikacija	
81188	max 2 kg	1

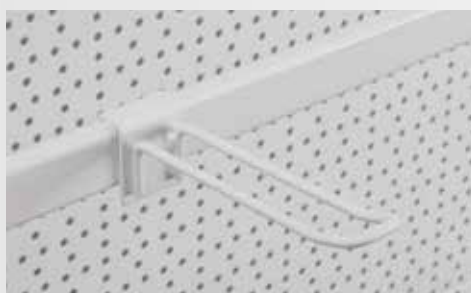

DVOSTRUKA KUKA

kompatibilan s FESTA postoljem

Broj	specifikacija	
81175	120 mm	1
81178	180 mm	1



KUKA

kompatibilan s FESTA postoljem

Broj	specifikacija	
81180	120 mm	1



Broj	specifikacija	
81200	stožer 40/2400 mm	1
81201	stožer 80/1108 mm	1
81202	stožer 80/1208 mm	1
81203	stožer 80/1408 mm	1
81204	Stožer 80/1608 mm	1
81205	Stožer 80/1808 mm	1
81206	Stožer 80/2000 mm	1
81207	Stožer 80/2108 mm	1
81208	Stožer 80/2208 mm	1
81209	Stožer 80/2308 mm	1
81210	Stožer 80/2408 mm	1
81211	Stožer 80/2600 mm	1
81212	Stožer 60/1000 mm	1
81213	Stožer 60/1208 mm	1
81214	Stožer 60/1408 mm	1
81215	Stožer 60/1608 mm	1
81216	Stožer 60/1808 mm	1
81217	Stožer 60/2108 mm	1
81218	Stožer 60/2208 mm	1
81225	Stožer 30/2108 mm prednji	1
81486	Stožer 60/2000 mm	1
81219	Nastavak stožera 80x30/100mm	1
81220	Nastavak stožera 80x30/400 mm	1
81221	Nastavak stožera 80x30/600 mm	1
81222	Nastavak stožera 60x30/400 mm	1
81223	Stožer Kutni 90° 2100mm	1
81224	Stožer Kutni 90° 2200mm	1
81226	Oslonac 80	1
81227	Oslonac 60	1
81228	Pokrivač gondole 80	1
81229	Letva za učvršćenje	1
81230	Kuka za učvršćenje	1
81231	Slabo učvršćenje	1
81232	Učvršćenje vrhom	1
81233	Punjenje 400	1
81234	Punjenje 500	1
81235	Punjenje 600	1
81236	Punjenje 700	1
81237	Punjenje 800	1
81238	Konzola niska 200	1
81239	Konzola niska 300	1
81240	Konzola niska 400	1
81241	Konzola niska 500	1
81242	Konzola visoka 400	1
81243	Konzola visoka 500	1
81244	Konzola visoka 600	1
81245	Konzola visoka 700	1
81246	Konzola niska 300 dupla	1
81247	Konzola niska 400 dupla	1
81248	Konzola niska 300 dupla	1
81251	Konzola RR 80	1
81249	Konzola visoka dupla 500	1
81250	Nosač visokog sanduka 400/2000	1
81252	Pregrada polica sa udubljenjem	1
81253	Pregrada niska 300	1
81254	Pregrada niska 400	1
81255	Pregrada niska 500	1
81256	Pregrada niska 300 staklo	1
81257	Pregrada niska 400 staklo	1
81258	Pregrada niska 500 staklo	1
81259	Pregrada visoka 300 staklo	1
81262	Pregrada visoka 300 plexi	1
81263	Pregrada visoka 400 plexi	1
81264	Pregrada visoka 500 plexi	1
81260	Pregrada visoka 400 staklo	1
81261	Pregrada visoka 500 staklo	1
81265	Bočna strana visokog sanduka 400/2000	1
81266	Bočne strane poklopca RR 80	1
81267	Bočna strana spremnika 500mm	1
81268	Bočne strane sanduka 500	1
81269	Gornji nosač sanduka 500	1
81271	Bočne strane polica niska 300 plast	1
81272	Bočne strane polica niska 400 plast	1
81273	Bočne strane polica niska 500 plast	1
81274	Bočne strane visoka sklo 300/250	1
81275	Osigurač bočne strane	1
81276	Bočne strane visoka sklo 500/250	1
81277	Bočne strane polica visoka 400	1
81278	Bočne strane polica visoka 500	1
81270	Nosač poklopca RR 80	1
81279	Nosač poklopca	1
81280	Bočne strane poklopca L	1
81281	Bočne strane poklopca P	1
81282	Potporna ruka	1
81284	Peg hook double 400/10	1
81285	Peg hook double 300/8	1
81286	Peg hook 350	1
81287	Peg hook 500	1
81288	Peg hook 250	1
81289	Double hinge 100	1
81290	Double hinge 200	1
81291	Double hinge 300	1
81292	Hinge 130 V	1

Broj	specifikacija	
81293	Hinge 100	1
81294	Hinge 200	1
81295	Hinge 300	1
81296	Jednokukica sa šipkom 200	1
81297	Jednokukica sa šipkom 300	1
81298	Izložba za zaključavanje	1
81299	Pregrada žica 360mm visoka	1
81300	Pregrada žica 460 mm visoka	1
81301	Pregrada žica 560 mm visoka	1
81302	Pregrada žica 560 mm niska	1
81303	Konzola 300 dupla L	1
81304	Konzola 300 dupla P	1
81305	Konzola 400 dupla L	1
81306	Konzola 400 dupla P	1
81307	Konzola 500 dupla L	1
81308	Konzola 500 dupla P	1
81309	Polica polukrug 300	1
81310	Polica polukrug 400	1
81311	Polica polukrug 500	1
81312	Stubna ploča polukrug 500	1
81313	Pređini stubna ploča polukrug 500	1
81314	Držač trake za cijene 300 polukrug	1
81315	Držač trake za cijene 400 polukrug	1
81316	Držač trake za cijene 500 polukrug	1
81317	Polica polukrug 600	1
81318	Stubna ploča polukrug 600	1
81319	Pređini stubna ploča polukrug 600	1
81320	Cijena P 7,5x5 cm	1
81321	Cijena P 2,6x3,2 cm	1
81322	Cijena P 5,0x4,0 cm	1
81323	Polica perf. 500/1000	1
81324	Spajanje stojin 80, modul 1	1
81325	Zadnji panel 10x100cm	1
81326	Zadnji panel 20x100cm	1
81327	Zadnji panel 40x100cm	1
81328	Zadnji panel perf. 20x100 cm EUR	1
81329	Zadnji panel perf. 40x100 cm EUR	1
81330	Pokrivač korpe 8x100cm	1
81331	Pokrivač korpe 6x100cm	1
81332	Fascia peg 100cm	1
81333	Polica staklo 985/300 vitrina	1
81334	Polica staklo 985/400 vitrina	1
81335	Polica drvena 47/98,5	1
81336	Polica žica 1000/500	1
81337	Polica korito 1000x500	1
81338	Polica 200/1000	1
81339	Polica 300/1000	1
81340	Polica 400/1000	1
81341	Polica 500/1000	1
81342	Polica 400/1000 RAL7015	1
81343	Polica 500/1000 RAL7015	1
81347	Frame of high display 1000/400	1
81348	Glass of high frame display 1000/400	1
81349	Drawer	1
81350	Suspended ceiling metal shelves 500/100	1
81352	Front support high glass 1000 mm	1
81353	Front support high plexi	1
81354	Front support low plastic 1000 mm	1
81355	Price bar, 1000mm	1
81356	Greben	1
81351	Greben - pregrada visoka, 1000	1
81357	Greben, 1000 mm	1
81403	Greben - pregrada visoka, 1250 mm	1
81420	Greben - pregrada visoka, 625 mm	1
81358	Double groove for doors of display	1
81359	Držač trake za cijene, 1000mm	1
81360	Doors of display 1000/2000	1
81361	Forehead of roof, 1000mm	1
81362	Plate of roof, 1000mm	1
81363	Doors of magazine	1
81364	Sliding door of display	1
81365	Mirror for display	1
81366	Frame to hang, modul 1	1
81367	Hanging pole	1
81370	Wire basket	1
81371	Tour 1000mm full plate	1
81372	Skirting the counter SU 5 1000mm	1
81373	Counter glassed 1000mm	1
81374	Counter with stainless steel plate 1000mm	1
81375	Counter with full plate 600mm	1
81376	Shelf counter 600mm	1
81377	Counter glassed 600mm	1
81378	Shelf counter 1000mm	1
81379	Long shelf counter	1
81380	Segment counter high 90°	1
81381	Double-groove counter 1000mm, couple	1
81382	Sliding doors counter 1000mm, couple	1
81383	Drawer board	1
81384	Wire shelf RDE 1000/360mm	1
81385	Wire shelf RDE 1000/460mm	1
81386	Wire shelf RDE 1000/560mm	1
81387	Traka za cijene RDE 1000 mm	1
81388	Zadnji panel 100/1250mm	1

Broj	specifikacija	
81389	Zadnji panel 200/1250mm	1
81390	Zadnji panel 400/1250mm	1
81391	Zadnji panel 200/1250mm perf.	1
81393	Pokrivač korpe 80/1250mm	1
81392	Zadnji panel 400/1250mm perf.	1
81394	Pokrivač korpe 60/1250mm	1
81395	Fascia peg 1250mm	1
81396	Polica 200/1250mm	1
81439	Fascia peg 1000 mm	1
81344	Polica 300/1000 Pojačana	1
81345	Polica 400/1000 Pojačana	1
81346	Polica 500/1000 Pojačana	1
81397	Polica 300/1250mm	1
81400	Polica 300/1250mm, Pojačana	1
81401	Polica 400/1250mm, Pojačana	1
81402	Polica 500/1250mm, Pojačana	1
81398	Polica 400/1250mm	1
81399	Polica 500/1250mm	1
81404	Front fulcrum low 1250mm, white plastic	1
81405	Traka za cijene, 1250mm	1
81406	Greben 1250mm	1
81407	Držač trake za cijene, 1250mm	1
81408	Forehead roofing, 1250mm	1
81409	Tile roofing, 600x1250mm	1
81410	Zadnji panel 100/625	1
81411	Zadnji panel 200/625	1
81412	Zadnji panel 400/625	1
81413	Zadnji panel 400/625 perf.	1
81414	Pokrivač korpe 80/650	1
81415	Pokrivač korpe 60/650	1
81416	Beam hinges, module 3	1
81432	Beam hinges, 1330mm	1
81417	Polica 300/625	1
81418	Polica 400/625	1
81419	Polica 500/625	1
81421	Front support low 625, white plastic	1
81422	Traka za cijene 625mm	1
81423	Greben 625mm	1
81424	Držač trake za cijene, 625mm	1
81425	Zadnji panel 100/1330	1
81457	Celní opšera nízká 200 plast	1
81426	Zadnji panel 200/1330	1
81427	Zadnji panel 400/1330	1
81428	Zadnji panel 200/1330 perf. S	1
81429	Zadnji panel 400/1330 perf. S	1
81430	Pokrivač korpe 80/1330	1
81431	Pokrivač korpe 60/1330	1
81433	Polica 300/1330	1
81434	Polica 400/1330	1
81435	Polica 500/1330	1
81436	Traka za cijene, 1330 mm	1
81437	Greben 1330 mm	1
81438	Držač trake za cijene 1330 mm	1
81440	Polica žica - korpe	1
81441	Zadnji panel 100 Kutni	1
81442	Zadnji panel 400 Kutni	1
81443	Celo soklu kutové 500/1000mm	1
81444	Celo soklu kutové 600 mm	1
81445	Zadnji panel kutový 400mm perf.	1
81447	Polica 300 Kutni	1
81448	Polica 400 Kutni	1
81449	Polica 500 Kutni	1
81450	Polica 600 Kutni	1
81451	Držač trake za cijene 300 Kutni	1
81452	Držač trake za cijene 400 Kutni	1
81453	Držač trake za cijene 500 Kutni	1
81454	Traka za cijene 300 Kutni	1
81455	Traka za cijene 400 Kutni	1
81456	Traka za cijene 500 Kutni	1
81458	Polica žičane korpe U 1000/400	1
81459	Polica žičane korpe U 1000/500	1
81460	Corner forehead plinth 90°	1
81461	Zadnji panel kutni 100, stožer 60	1
81462	Zadnji panel kutni 200, stožer 60	1
81463	Zadnji panel kutni 400, stožer 80	1
81466	Zadnji panel kutni 100, stožer 80	1
81467	Zadnji panel kutni 400, stožer 60	1
81468	Polica kutni 90° 400mm	1
81469	Polica kutni 90° 500mm	1
81470	Držač trake za cijene kutni 90° 400mm	1
81471	Držač trake za cijene kutni 90° 500mm	1
81472	Traka za cijene kutni 90° 400mm	1
81473	Traka za cijene kutni 90° 500mm	1



DRŽAČ POLICA – BIJELA

MOQ
2

Broj	specifikacija	
81100	100 x 75 mm	24
81101	125 x 100 mm	24
81102	150 x 125 mm	24
81103	200 x 150 mm	24
81104	250 x 200 mm	24
81105	300 x 250 mm	24
81106	350 x 300 mm	24



DRŽAČ (NOGA) REGALA

Broj	specifikacija	
81053	50 cm	10
81054	80 cm	10
81057	200 cm	10



DRŽAČ POLICA ZA REGAL

Broj	specifikacija	
81070	10 cm	10
81071	15 cm	10
81077	50 cm	10



KARTONSKI ŠTAND ALATA ZA NIVELIRANJE



Broj	specifikacija	
37179	60 x 40 x 175 cm - ENG	1



KARTONSKI ŠTAND ZA ALAT FESTA



Broj	specifikacija	
81602	60 x 40 x 175 cm - ENG	1

KARTONSKI ŠTAND ZA AKU ALAT FESTA



Broj	specifikacija	
81603	60 x 40 x 175 cm	1



FESTA

REKLAMNI BLOK FESTA

Broj	specifikacija
M90400	



FESTA

REKLAMNA MAJICA CRVENA FESTA

Broj	specifikacija	
M90203	M	1
M90204	L	1
M90205	XL	1
M90206	XXL	1
M90207	XXXL	1



FESTA

REKLAMNA OLOVKA FESTA

Broj	specifikacija
M90403	



FESTA

REKLAMNI USB KABEL FESTA

Broj	specifikacija
M90519	



FESTA

REKLAMNE ČARAPE FESTA

Broj	specifikacija	
M90220	39-41	1
M90221	42-44	1
M90222	45-47	1



FESTA

REKLAMNI METAR FESTA

Broj	specifikacija
11410	2 m x 16 mm



FESTA

REKLAMNA KAPA FESTA

Broj	specifikacija	
M90210		1



FESTA

REKLAMNI SKLOPIVI NOŽ FESTA

Broj	specifikacija
16209	



šifra	stranica	šifra	stranica	šifra	stranica	šifra	stranica	šifra	stranica	šifra	stranica
10002	96	11355	98	13249	121	13414	101	13509	99	14420	104
10003	96	11356	98	13250	121	13415	101	13510	99	14421	104
10005	96	11358	98	13251	121	13416	101	13511	99	14425	105
10008	96	11360	98	13252	121	13417	101	13512	99	14430	105
10025	96	11410	100	13253	121	13418	101	13513	99	14435	105
10033	96	11410	365	13254	121	13419	101	13514	99	14440	105
10035	96	11416	99	13255	121	13420	101	13515	99	14445	105
10043	96	11420	100	13256	121	13421	101	13516	99	14446	105
10045	96	11425	100	13257	121	13422	101	13517	99	14450	105
10048	96	11444	100	13258	121	13423	101	13518	99	14451	105
10110	96	11445	100	13259	121	13424	101	13519	99	14455	105
10120	96	12010	99	13260	120	13425	101	13520	99	14456	105
10130	96	12020	99	13261	117	13426	101	13521	99	14457	105
10330	96	12030	99	13262	117	13427	101	13522	99	14458	105
10332	96	12050	99	13263	117	13428	101	13523	99	14471	105
10334	96	12110	99	13264	116	13429	101	13524	99	14472	105
10336	96	12120	99	13265	116	13430	101	13525	99	14473	105
10430	97	12130	99	13266	116	13431	101	13526	99	14474	105
10450	97	12150	99	13267	117	13432	101	13527	99	14480	104
10490	97	12220	99	13268	116	13433	101	13528	99	14485	109
10996	97	12230	99	13269	116	13434	101	13529	99	14485	271
10998	97	12250	99	13270	116	13435	101	13530	99	14486	109
10999	97	12433	100	13271	116	13436	101	13531	99	14486	271
11002	99	12435	100	13272	116	13437	101	13532	99	14490	105
11003	99	13010	101	13273	116	13438	101	13533	99	14491	105
11005	99	13020	101	13274	116	13439	101	13534	99	14492	105
11006	99	13021	101	13275	116	13440	101	14001	102	14493	105
11007	99	13022	101	13276	117	13441	101	14002	102	14494	105
11008	99	13023	101	13277	120	13442	101	14003	102	15003	107
11082	99	13111	101	13278	116	13443	101	14004	102	15004	107
11083	99	13120	101	13279	117	13444	101	14006	102	15005	107
11085	99	13200	118	13280	117	13445	101	14007	102	15006	107
11102	98	13201	118	13281	102	13446	101	14008	102	15008	107
11103	98	13202	118	13282	102	13447	101	14009	102	15010	107
11105	98	13205	119	13284	117	13448	101	14010	103	15012	107
11106	98	13206	119	13285	102	13449	101	14011	103	15015	107
11107	98	13207	119	13288	117	13450	101	14012	103	15018	107
11110	98	13208	119	13290	217	13451	101	14013	102	15020	107
11200	99	13211	101	13293	217	13452	101	14015	103	15033	106
11201	99	13212	119	13294	217	13453	101	14017	103	15034	106
11202	99	13214	118	13295	120	13454	101	14019	103	15035	106
11204	99	13216	118	13296	120	13455	101	14025	105	15036	106
11205	99	13217	118	13350	121	13456	101	14030	103	15037	106
11206	99	13218	118	13351	121	13457	101	14035	102	15039	106
11207	99	13219	118	13352	121	13458	101	14040	102	15103	107
11208	99	13220	101	13353	121	13459	101	14045	102	15104	107
11209	99	13222	118	13354	121	13460	101	14060	103	15105	107
11210	99	13223	118	13355	121	13461	101	14070	103	15106	107
11220	98	13224	118	13360	121	13462	101	14075	103	15108	107
11221	98	13225	118	13361	121	13463	101	14077	103	15110	107
11226	98	13226	118	13362	121	13464	101	14080	102	15112	107
11239	98	13227	118	13363	121	13465	101	14090	104	15115	107
11259	98	13228	118	13364	121	13466	101	14091	104	15118	107
11260	98	13229	118	13365	121	13467	101	14220	105	15120	107
11311	100	13230	118	13399	101	13468	101	14225	105	15204	107
11312	100	13231	118	13400	101	13469	101	14230	105	15205	107
11313	100	13235	118	13401	101	13470	101	14235	105	15206	107
11314	100	13236	118	13402	101	13471	101	14240	105	15208	107
11323	98	13237	118	13403	101	13472	101	14250	105	15210	107
11325	98	13238	118	13404	101	13473	101	14350	105	15212	107
11327	98	13240	120	13405	101	13500	99	14360	105	15215	107
11333	98	13241	120	13406	101	13501	99	14370	105	15218	107
11335	98	13242	120	13407	101	13502	99	14380	105	15220	107
11337	98	13243	120	13408	101	13503	99	14399	105	15230	107
11338	98	13244	120	13409	101	13504	99	14410	105	15235	108
11343	98	13245	120	13410	101	13505	99	14411	105	15301	109
11345	98	13246	119	13411	101	13506	99	14415	104	15301	271
11347	98	13247	119	13412	101	13507	99	14417	104	15310	108
11353	98	13248	119	13413	101	13508	99	14418	104	15310	270

POPIS KATALOŠKIH BROJEVA



šifra	stranica	šifra	stranica	šifra	stranica	šifra	stranica	šifra	stranica	šifra	stranica
15315	108	15810	109	16003	122	16075	130	16300	139	17037	137
15315	270	15810	271	16004	122	16077	130	16301	139	17038	177
15318	108	15812	109	16005	122	16078	130	16303	139	17039	176
15318	270	15812	271	16006	122	16081	130	16304	139	17040	174
15320	108	15815	109	16010	122	16082	129	16305	138	17041	174
15320	270	15815	271	16010	122	16083	131	16306	138	17042	174
15325	108	15818	109	16011	122	16084	131	16307	138	17043	174
15325	270	15818	271	16011	122	16085	126	16308	138	17044	174
15330	108	15820	109	16011	122	16086	126	16309	138	17045	174
15330	270	15820	271	16012	122	16087	127	16310	139	17046	177
15335	108	15825	109	16012	122	16090	125	16310	139	17047	172
15335	270	15825	271	16012	122	16091	125	16311	139	17048	177
15340	108	15830	109	16013	122	16095	127	16311	139	17049	177
15340	270	15830	271	16013	122	16099	124	16311	139	17050	139
15415	108	15850	109	16016	122	16100	124	16312	139	17050	181
15415	270	15850	271	16017	122	16105	124	16312	139	17051	177
15418	108	15853	109	16019	122	16110	124	16315	137	17052	177
15418	270	15853	271	16021	128	16115	124	16315	137	17053	177
15420	108	15855	109	16023	127	16120	124	16319	139	17054	177
15420	270	15855	271	16024	128	16125	124	16320	139	17055	177
15425	108	15860	109	16025	125	16130	126	16321	139	17056	177
15425	270	15860	271	16026	128	16131	124	16321	229	17057	177
15430	108	15870	109	16028	128	16135	126	16401	181	17058	177
15430	270	15870	271	16029	125	16136	125	16405	181	17059	176
15510	108	15880	109	16030	128	16137	125	16406	181	17060	176
15510	270	15880	271	16031	128	16140	126	16407	181	17061	176
15515	108	15885	256	16032	128	16141	128	16408	181	17062	176
15515	270	15886	256	16033	127	16142	125	16420	181	17063	175
15518	108	15886	349	16034	126	16143	125	16500	176	17064	175
15518	270	15887	256	16035	127	16144	125	16501	176	17065	175
15520	108	15887	349	16036	129	16145	125	16502	176	17066	175
15520	270	15888	256	16037	127	16146	125	16990	136	17067	175
15525	108	15888	349	16039	127	16147	126	16990	320	17068	175
15525	270	15889	256	16041	129	16150	125	16991	136	17069	175
15530	108	15893	109	16042	129	16151	125	16991	320	17070	175
15530	270	15893	271	16042	279	16198	131	16998	122	17071	175
15535	108	15894	109	16043	128	16199	131	16999	122	17072	175
15535	270	15894	271	16044	126	16201	132	17001	171	17075	175
15540	108	15895	109	16046	128	16202	173	17002	171	17076	175
15540	270	15895	271	16049	129	16205	173	17003	171	17077	175
15615	108	15904	111	16050	129	16206	173	17004	171	17078	177
15615	270	15906	111	16051	129	16208	173	17005	171	17079	176
15620	108	15908	111	16052	129	16209	133	17006	171	17080	176
15620	270	15910	111	16053	128	16209	365	17007	171	17081	176
15625	108	15912	111	16054	129	16210	132	17008	171	17082	176
15625	270	15915	111	16055	128	16211	132	17009	171	17083	178
15630	108	15920	111	16056	278	16212	132	17010	171	17084	176
15630	270	15954	111	16057	126	16218	133	17011	171	17085	176
15710	109	15956	111	16058	126	16219	133	17012	176	17086	176
15710	270	15958	111	16059	129	16220	133	17013	176	17087	172
15715	109	15960	111	16060	130	16221	133	17014	176	17089	178
15715	270	15962	111	16061	130	16222	133	17015	178	17090	178
15720	109	15965	111	16062	130	16223	133	17016	178	17091	178
15720	270	15970	111	16063	130	16224	134	17017	178	17092	178
15725	109	15980	111	16064	130	16225	132	17019	178	17093	178
15725	270	15981	111	16065	130	16226	134	17020	177	17094	171
15730	109	15983	100	16066	124	16227	134	17021	177	17095	171
15730	270	15985	100	16066	130	16228	134	17022	177	17096	171
15735	109	15988	100	16067	130	16229	132	17023	175	17097	171
15735	270	15989	100	16068	130	16230	132	17024	171	17098	171
15740	109	15990	111	16069	129	16231	132	17025	174	17099	171
15740	270	15991	111	16070	129	16231	135	17026	137	17100	171
15754	110	15992	111	16070	131	16232	134	17027	137	17101	169
15756	110	15993	111	16071	127	16232	174	17028	177	17102	169
15758	110	15996	110	16071	130	16234	132	17029	176	17103	169
15760	110	15997	110	16072	130	16235	133	17033	176	17104	169
15762	110	15998	110	16073	131	16236	133	17034	175	17105	169
15768	110	15999	110	16074	126	16281	127	17035	175	17108	171
15770	110	16002	122	16074	131	16282	127	17036	175	17109	175

šifra	stranica	šifra	stranica	šifra	stranica	šifra	stranica	šifra	stranica	šifra	stranica
17110	171	17238	156	17393	160	17528	165	17622	164	17831	159
17111	179	17240	158	17394	160	17532	166	17623	164	17832	159
17112	179	17241	158	17395	160	17533	166	17624	164	17835	159
17113	179	17242	158	17396	160	17534	166	17625	164	17836	159
17116	179	17243	158	17397	160	17539	165	17626	164	17837	159
17117	179	17244	158	17398	160	17548	164	17628	164	17838	159
17121	179	17245	155	17400	161	17549	164	17629	164	17839	159
17122	179	17247	153	17401	160	17550	164	17630	164	17840	159
17125	172	17250	161	17402	160	17551	164	17631	164	17841	159
17126	172	17255	161	17405	160	17552	164	17632	164	17842	159
17127	172	17259	153	17406	160	17553	164	17633	164	17843	159
17128	172	17260	153	17407	160	17554	164	17640	166	17844	159
17130	172	17261	167	17410	160	17555	164	17642	166	17845	159
17133	172	17262	167	17411	160	17556	164	17643	166	17846	159
17135	172	17292	158	17412	160	17557	164	17644	166	17847	159
17137	172	17294	158	17413	160	17558	164	17645	166	17848	159
17138	172	17295	158	17414	160	17559	164	17650	166	17849	159
17140	169	17296	158	17415	160	17560	164	17651	166	17850	159
17142	169	17297	158	17416	160	17561	164	17652	166	17851	159
17145	169	17298	158	17420	160	17562	164	17653	166	17852	159
17146	169	17299	158	17421	160	17563	164	17654	166	17853	159
17148	169	17300	178	17422	160	17564	164	17655	166	17854	159
17150	175	17301	178	17427	161	17565	164	17656	166	17855	159
17151	175	17302	178	17450	167	17566	164	17657	166	17856	159
17158	181	17303	178	17451	167	17567	164	17658	166	17860	159
17159	181	17304	178	17452	167	17568	164	17659	166	17861	159
17160	181	17305	178	17454	168	17569	164	17660	164	17862	159
17165	179	17306	178	17455	161	17570	164	17661	164	17863	159
17167	179	17308	159	17455	168	17571	164	17662	164	17864	159
17169	179	17309	159	17456	168	17572	164	17663	164	17865	159
17170	179	17310	159	17458	168	17573	164	17664	164	17866	159
17172	178	17311	159	17459	168	17574	164	17665	164	17867	159
17175	180	17312	159	17460	164	17575	164	17666	164	17868	159
17177	180	17313	159	17461	164	17576	164	17667	164	17869	159
17178	172	17314	159	17462	164	17577	164	17668	164	17870	159
17180	172	17315	159	17463	164	17578	164	17669	164	17871	159
17181	172	17316	159	17464	164	17579	164	17670	164	17872	159
17182	45	17317	159	17465	164	17580	164	17671	164	17873	159
17182	137	17318	159	17467	164	17581	164	17672	164	17874	159
17183	45	17319	159	17468	164	17582	164	17674	164	17875	159
17183	137	17320	159	17469	164	17583	164	17675	164	17876	159
17185	181	17321	159	17470	164	17584	164	17676	164	17877	159
17186	180	17322	159	17471	164	17585	164	17677	164	17878	159
17187	181	17324	159	17472	164	17586	164	17678	164	17879	159
17188	181	17327	159	17473	164	17587	164	17679	164	17880	159
17189	181	17330	159	17475	166	17589	164	17680	168	17881	159
17190	174	17332	159	17476	166	17590	164	17681	168	17882	159
17191	174	17333	159	17480	164	17591	164	17682	168	17883	159
17192	174	17334	159	17481	164	17592	164	17683	164	17884	159
17193	174	17338	167	17482	164	17593	164	17685	165	17885	159
17197	165	17341	178	17483	164	17600	167	17761	164	17886	159
17198	165	17342	178	17484	164	17601	167	17769	164	17887	159
17199	165	17350	162	17485	164	17603	167	17788	164	17888	159
17200	165	17351	162	17486	164	17605	164	17795	164	17889	159
17201	165	17352	162	17487	164	17606	164	17806	164	17890	159
17202	165	17353	162	17488	164	17607	164	17810	161	17891	159
17203	167	17357	162	17489	164	17608	164	17811	161	17892	159
17204	167	17359	162	17490	164	17609	164	17812	161	17895	159
17205	167	17361	162	17491	164	17610	164	17820	159	17896	159
17206	167	17380	161	17492	164	17611	164	17821	159	17897	159
17229	155	17381	161	17493	164	17612	164	17822	159	17898	159
17230	155	17382	160	17494	164	17613	164	17823	159	17904	159
17231	155	17383	160	17495	164	17614	164	17824	159	17905	159
17233	155	17384	160	17496	164	17615	164	17825	159	17907	159
17234	155	17385	160	17501	166	17616	164	17826	159	17910	159
17235	156	17386	160	17506	165	17617	164	17827	159	17914	159
17236	156	17390	160	17508	165	17619	165	17828	159	17916	159
17237	154	17391	160	17512	166	17620	166	17829	159	17922	159
17238	153	17392	160	17526	165	17621	166	17830	159	17924	159

POPIS KATALOŠKIH BROJEVA



šifra	stranica	šifra	stranica	šifra	stranica	šifra	stranica	šifra	stranica	šifra	stranica
17926	159	18302	143	18498	163	18638	147	18828	148	18971	160
17930	159	18303	143	18499	163	18639	147	18829	148	18993	150
17934	159	18304	143	18500	163	18640	147	18830	148	18994	150
17935	159	18310	140	18501	162	18641	147	18831	148	19001	197
17943	159	18311	140	18508	163	18645	147	18832	148	19002	197
17944	159	18312	140	18510	162	18646	147	18835	148	19003	197
17970	148	18313	140	18511	162	18680	147	18836	148	19004	197
17971	148	18321	140	18512	162	18685	147	18837	148	19005	197
17972	148	18322	140	18513	162	18710	146	18838	148	19006	197
17973	148	18340	141	18514	162	18711	146	18839	148	19008	197
17974	148	18350	140	18515	162	18712	146	18840	148	19010	197
17975	148	18351	140	18516	162	18715	146	18841	148	19015	197
17976	148	18352	140	18518	162	18716	146	18842	148	19020	197
17980	148	18353	140	18519	162	18717	146	18843	148	19021	195
17981	148	18354	140	18520	162	18720	146	18844	148	19022	195
17982	148	18355	140	18521	162	18721	146	18845	148	19023	195
17983	148	18356	140	18522	162	18722	146	18846	148	19024	195
18062	142	18357	140	18523	162	18723	146	18847	148	19025	195
18063	142	18358	140	18524	162	18724	146	18850	148	19026	195
18064	142	18359	140	18527	162	18725	146	18851	148	19028	195
18065	142	18360	140	18567	162	18750	147	18852	148	19030	195
18066	142	18400	143	18572	162	18751	147	18853	148	19031	195
18067	142	18401	143	18575	162	18753	147	18855	148	19032	195
18070	142	18402	141	18576	162	18755	147	18856	148	19034	195
18071	142	18403	141	18577	162	18760	147	18860	148	19036	195
18072	142	18404	141	18578	162	18761	147	18861	148	19041	195
18075	142	18408	145	18579	162	18762	147	18862	148	19042	195
18076	142	18409	145	18580	162	18763	147	18863	148	19043	195
18077	142	18410	142	18581	162	18764	147	18864	148	19044	195
18080	142	18411	142	18582	162	18765	147	18865	148	19045	195
18081	142	18413	142	18583	162	18766	147	18866	148	19046	195
18082	142	18415	144	18584	162	18767	147	18867	148	19050	197
18083	142	18416	144	18585	162	18768	147	18868	148	19051	197
18084	142	18417	144	18587	162	18769	147	18869	148	19052	197
18085	142	18418	143	18588	162	18770	147	18870	148	19053	197
18086	142	18419	144	18589	162	18771	147	18871	148	19054	197
18087	142	18420	144	18593	162	18772	147	18872	148	19055	197
18088	142	18421	152	18600	149	18775	147	18873	148	19056	197
18089	142	18422	141	18601	149	18776	147	18874	148	19057	197
18090	142	18423	142	18602	149	18777	147	18900	151	19058	195
18091	142	18424	141	18603	158	18795	149	18901	151	19059	195
18092	142	18425	140	18604	161	18796	149	18905	151	19060	196
18101	143	18426	145	18605	149	18797	149	18906	151	19061	196
18102	143	18427	145	18607	149	18798	149	18907	152	19062	196
18103	143	18428	115	18608	144	18799	149	18908	151	19063	196
18104	143	18429	115	18609	150	18800	148	18909	151	19064	196
18105	143	18430	152	18610	150	18801	148	18910	145	19065	196
18106	143	18431	144	18611	150	18802	148	18915	152	19066	195
18107	143	18432	146	18612	150	18803	148	18920	160	19067	195
18108	143	18433	144	18613	150	18804	148	18921	160	19068	195
18110	143	18434	140	18614	150	18805	148	18922	160	19069	195
18113	140	18435	145	18615	150	18806	148	18925	160	19070	195
18114	140	18437	145	18618	150	18807	148	18926	160	19071	195
18115	140	18440	152	18619	149	18810	148	18927	160	19074	195
18116	140	18445	173	18619	161	18811	148	18928	160	19075	195
18118	140	18450	143	18620	147	18812	148	18929	160	19076	195
18120	140	18451	143	18621	147	18813	148	18930	160	19077	195
18124	140	18455	143	18623	147	18814	148	18931	160	19081	195
18125	140	18456	143	18625	147	18815	148	18934	160	19082	195
18201	143	18460	143	18627	147	18816	148	18939	160	19083	195
18202	143	18476	162	18628	147	18817	148	18948	160	19084	195
18203	143	18490	163	18630	147	18820	148	18950	160	19085	195
18204	143	18491	163	18631	147	18821	148	18951	160	19086	195
18210	140	18492	163	18632	147	18822	148	18954	160	19088	195
18211	140	18493	163	18633	147	18823	148	18955	160	19090	195
18212	140	18494	162	18634	147	18824	148	18956	160	19092	195
18215	140	18495	162	18635	147	18825	148	18960	160	19095	195
18216	140	18496	163	18636	147	18826	148	18961	160	19096	195
18301	143	18497	163	18637	147	18827	148	18963	160	19097	195

šifra	stranica	šifra	stranica	šifra	stranica	šifra	stranica	šifra	stranica	šifra	stranica
19098	195	19394	317	19473	202	19580	56	19643	56	19704	57
19100	196	19395	317	19474	202	19585	56	19644	56	19705	57
19106	195	19396	317	19477	202	19585	56	19645	56	19705	57
19108	195	19397	317	19478	202	19586	56	19645	56	19706	57
19109	195	19398	197	19480	202	19587	56	19646	56	19707	57
19110	200	19399	197	19481	202	19588	56	19647	56	19708	57
19115	44	19400	201	19483	202	19589	56	19648	56	19708	57
19115	197	19400	251	19485	201	19590	56	19649	56	19709	57
19124	196	19401	201	19486	201	19590	56	19650	56	19710	57
19136	196	19401	251	19487	201	19591	56	19650	56	19711	57
19148	196	19402	201	19490	135	19593	56	19651	56	19711	57
19149	196	19402	251	19491	135	19594	56	19652	56	19712	57
19150	196	19403	201	19492	135	19595	56	19653	56	19713	57
19151	196	19403	251	19493	135	19595	56	19654	56	19713	57
19202	198	19404	201	19494	135	19596	56	19655	56	19714	57
19208	199	19404	251	19495	135	19597	56	19656	56	19715	57
19209	199	19405	201	19496	135	19598	56	19657	56	19716	57
19211	199	19405	251	19497	135	19599	56	19658	56	19717	57
19245	198	19406	201	19498	135	19600	56	19659	56	19718	57
19246	198	19406	251	19499	135	19600	56	19660	56	19718	57
19247	198	19407	201	19501	135	19601	56	19661	56	19719	57
19248	198	19407	251	19502	135	19603	56	19662	56	19720	57
19249	198	19408	201	19510	134	19604	56	19663	56	19721	57
19251	199	19408	251	19515	134	19605	56	19664	56	19722	57
19252	199	19409	201	19520	134	19605	56	19665	56	19723	57
19253	199	19409	251	19530	56	19606	56	19669	56	19723	57
19254	199	19410	201	19530	56	19607	56	19670	57	19724	57
19255	199	19411	201	19535	56	19608	56	19671	57	19725	57
19265	199	19412	201	19535	56	19609	56	19672	57	19726	57
19270	199	19415	200	19536	56	19610	56	19673	57	19727	57
19271	199	19416	200	19537	56	19610	56	19673	57	19728	57
19272	199	19418	201	19538	56	19611	56	19674	57	19728	57
19281	199	19419	201	19539	56	19612	56	19675	57	19729	57
19290	199	19420	200	19540	56	19613	56	19676	57	19730	57
19293	199	19421	200	19540	56	19614	56	19677	57	19731	57
19294	199	19422	200	19543	56	19615	56	19678	57	19732	57
19295	199	19423	200	19544	56	19615	56	19678	57	19733	57
19297	199	19424	200	19545	56	19616	56	19679	57	19733	57
19301	316	19425	200	19545	56	19617	56	19680	57	19734	57
19303	196	19426	200	19550	56	19618	56	19681	57	19735	57
19306	317	19427	200	19550	56	19619	56	19682	57	19736	57
19308	317	19429	201	19552	56	19620	56	19683	57	19737	57
19310	317	19430	197	19552	56	19620	56	19683	57	19738	57
19312	317	19431	197	19554	56	19621	56	19684	57	19738	57
19314	317	19432	197	19555	56	19622	56	19685	57	19739	57
19326	316	19433	197	19555	56	19623	56	19686	57	19740	57
19328	316	19434	197	19557	56	19624	56	19687	57	19741	57
19330	316	19435	197	19558	56	19625	56	19688	57	19742	57
19332	316	19436	201	19559	56	19625	56	19688	57	19743	57
19333	316	19440	197	19560	56	19626	56	19689	57	19743	57
19335	316	19441	197	19560	56	19627	56	19690	57	19744	57
19337	316	19442	197	19562	56	19628	56	19691	57	19745	57
19340	316	19443	197	19562	56	19629	56	19692	57	19746	57
19370	317	19450	135	19564	56	19630	56	19693	57	19747	57
19371	317	19451	135	19565	56	19630	56	19693	57	19748	57
19374	317	19455	135	19565	56	19631	56	19694	57	19748	57
19380	316	19457	135	19567	56	19632	56	19695	57	19749	57
19381	316	19458	135	19568	56	19633	56	19695	57	19750	57
19382	316	19459	135	19568	56	19634	56	19696	57	19751	57
19383	316	19460	201	19570	56	19635	56	19697	57	19752	57
19384	316	19460	251	19570	56	19635	56	19698	57	19753	57
19385	316	19462	317	19574	56	19636	56	19698	57	19753	57
19387	316	19463	317	19575	56	19637	56	19699	57	19754	57
19388	316	19464	317	19575	56	19638	56	19700	57	19755	57
19389	316	19465	317	19576	56	19639	56	19701	57	19756	57
19390	316	19469	317	19577	56	19640	56	19701	57	19757	57
19391	316	19470	201	19578	56	19640	56	19702	57	19758	57
19392	316	19470	251	19579	56	19641	56	19703	57	19758	57
19393	317	19472	202	19580	56	19642	56	19703	57	19759	57

POPIS KATALOŠKIH BROJEVA



šifra	stranica	šifra	stranica	šifra	stranica	šifra	stranica	šifra	stranica	šifra	stranica
19760	57	20300	59	20489	61	20751	67	20896	63	21110	75
19761	57	20305	59	20490	61	20752	67	20897	63	21111	75
19762	57	20310	59	20491	61	20753	67	20898	63	21112	75
19763	57	20311	59	20492	61	20754	67	20899	63	21115	75
19763	57	20315	60	20493	61	20755	67	20901	64	21118	75
19764	57	20316	59	20494	61	20756	67	20905	64	21123	75
19765	57	20317	59	20495	61	20757	67	20910	64	21130	75
19766	57	20320	60	20496	61	20758	67	20911	63	21135	75
19767	57	20321	60	20508	67	20759	67	20912	63	21140	75
19768	57	20333	58	20510	67	20760	67	20913	63	21150	75
19768	57	20334	58	20511	67	20761	67	20915	63	21180	75
19769	57	20335	58	20512	67	20762	67	20916	63	21190	75
19770	57	20336	58	20513	67	20764	67	20917	63	21192	77
19771	57	20337	58	20514	67	20765	67	20918	63	21194	77
19772	57	20338	58	20515	67	20766	67	20919	63	21195	75
19772	57	20340	60	20516	67	20767	67	20920	63	21200	74
19773	57	20350	202	20520	67	20768	67	20921	63	21201	74
19774	57	20360	139	20521	67	20769	67	20922	63	21203	74
19775	57	20361	139	20522	67	20770	67	20923	63	21204	74
19776	57	20363	180	20523	67	20771	67	20924	63	21205	74
19776	57	20364	180	20524	67	20772	67	20932	69	21209	74
19777	57	20365	29	20525	67	20773	67	20936	69	21210	75
19778	57	20379	29	20526	67	20774	67	20937	69	21211	75
19779	57	20380	60	20673	67	20775	67	20938	69	21212	75
19780	57	20381	64	20674	67	20776	67	20939	69	21215	75
19781	57	20385	62	20675	67	20777	67	20940	69	21218	75
19781	57	20386	62	20676	67	20778	67	20941	69	21219	75
19782	57	20387	62	20677	67	20779	67	20942	69	21220	75
19783	57	20390	62	20678	67	20780	67	20943	69	21223	75
19783	57	20391	62	20680	67	20781	67	20944	69	21224	75
19784	57	20394	62	20682	67	20782	67	20945	69	21230	74
19785	57	20395	62	20684	67	20783	67	20946	69	21231	74
19786	57	20396	62	20685	67	20784	67	20947	69	21234	74
19786	57	20397	62	20686	67	20785	67	20948	69	21235	74
19787	57	20400	58	20687	67	20786	67	20949	69	21238	74
19788	57	20401	58	20688	67	20787	67	20950	68	21301	75
19789	57	20402	58	20690	67	20788	67	20952	68	21303	75
19790	57	20403	58	20691	67	20789	67	20954	68	21306	77
19791	57	20404	58	20692	67	20790	67	20956	69	21308	77
19792	57	20405	58	20694	67	20791	67	20957	63	21311	75
19793	57	20406	58	20696	67	20792	67	20958	63	21312	75
19794	57	20407	58	20697	67	20793	67	20960	29	21315	75
19795	57	20408	58	20698	67	20794	67	20961	29	21318	75
19796	57	20409	58	20724	63	20795	67	20963	29	21323	75
19797	57	20410	58	20725	63	20796	67	20965	29	21324	75
19798	57	20411	58	20726	63	20797	67	20966	29	21326	75
19799	57	20412	58	20727	63	20798	67	20967	166	21327	75
19800	57	20413	58	20728	63	20799	67	20968	166	21411	75
19801	57	20414	58	20729	63	20805	68	20970	202	21412	75
19802	57	20415	58	20730	63	20820	68	20971	202	21415	75
19841	58	20416	58	20731	63	20825	67	20972	202	21418	75
19842	58	20417	58	20732	63	20855	67	20973	202	21423	75
19845	58	20418	58	20733	63	20861	67	20980	63	21424	75
19885	58	20419	58	20734	63	20862	67	20981	63	21425	76
19895	58	20420	58	20735	63	20870	67	20982	63	21426	76
20210	64	20421	58	20736	63	20871	67	20983	63	21427	76
20220	57	20422	58	20737	63	20872	67	20984	63	21428	76
20225	57	20423	58	20738	63	20873	67	20990	69	21430	76
20230	57	20424	58	20739	63	20874	67	20991	69	21431	76
20235	57	20425	58	20740	63	20875	67	20992	69	21432	76
20240	57	20426	58	20741	63	20876	67	20996	68	21435	76
20245	57	20427	58	20742	150	20877	67	20997	69	21436	76
20250	57	20428	58	20743	29	20878	67	20999	68	21437	76
20255	57	20429	58	20743	149	20879	67	21010	75	21440	64
20260	57	20430	58	20744	29	20880	67	21011	75	21441	64
20270	57	20450	64	20745	29	20881	67	21012	75	21442	64
20280	57	20460	64	20748	67	20890	68	21015	75	21443	64
20290	57	20487	61	20749	67	20891	68	21018	75	21444	64
20296	57	20488	61	20750	67	20895	68	21023	75	21445	64

šifra	stranica	šifra	stranica	šifra	stranica	šifra	stranica	šifra	stranica	šifra	stranica
21446	64	21803	78	22012	81	22083	82	22170	189	22277	76
21450	66	21804	78	22013	81	22084	82	22171	189	22280	76
21451	66	21805	78	22014	81	22085	82	22172	189	22281	76
21452	66	21806	78	22015	81	22086	187	22173	189	22285	76
21453	66	21807	65	22016	81	22087	83	22174	189	22286	76
21454	66	21807	78	22017	81	22088	82	22178	188	22294	76
21530	64	21808	65	22018	81	22090	82	22180	188	22300	86
21531	63	21808	78	22019	81	22091	83	22181	188	22301	86
21532	63	21809	79	22020	81	22092	83	22182	188	22302	86
21533	63	21810	84	22021	81	22093	83	22183	188	22303	86
21534	63	21811	84	22022	81	22095	82	22184	188	22305	86
21535	63	21812	84	22023	81	22096	84	22185	188	22307	86
21536	63	21813	84	22024	81	22097	84	22186	188	22309	86
21540	66	21814	84	22025	81	22098	84	22188	189	22310	86
21541	66	21831	84	22026	81	22099	84	22189	189	22311	86
21701	84	21832	84	22027	81	22100	85	22190	189	22312	86
21702	84	21834	84	22028	81	22101	85	22196	189	22313	86
21703	84	21850	85	22029	81	22102	85	22197	189	22314	86
21704	84	21851	85	22030	81	22103	85	22198	189	22315	86
21705	84	21852	85	22031	81	22104	85	22199	189	22316	86
21706	84	21853	85	22032	82	22105	85	22200	70	22317	86
21709	84	21854	85	22033	187	22106	85	22201	70	22318	86
21715	84	21855	85	22034	187	22107	85	22202	189	22319	86
21716	84	21856	85	22035	187	22108	85	22203	189	22320	86
21717	84	21857	85	22036	187	22109	85	22204	189	22322	86
21718	84	21858	85	22037	80	22110	85	22205	189	22324	86
21719	84	21859	85	22038	80	22111	85	22206	188	22326	86
21720	84	21860	85	22039	81	22112	85	22207	188	22328	86
21721	84	21861	85	22040	81	22113	85	22208	188	22329	86
21724	84	21862	85	22041	83	22115	85	22209	188	22332	86
21732	84	21863	85	22042	83	22116	85	22211	77	22333	86
21734	84	21864	85	22043	83	22117	85	22212	77	22335	86
21735	84	21900	80	22044	83	22119	85	22215	77	22337	86
21736	84	21901	80	22045	84	22120	293	22216	77	22340	86
21737	84	21902	80	22046	84	22121	293	22217	77	22343	86
21740	84	21903	80	22047	84	22122	293	22218	77	22345	86
21741	84	21904	80	22048	84	22123	293	22219	77	22350	86
21742	84	21905	80	22049	84	22124	293	22220	77	22351	86
21743	84	21906	80	22050	84	22125	293	22222	77	22355	86
21744	84	21907	80	22051	84	22126	293	22224	77	22357	86
21750	84	21908	80	22052	84	22129	293	22225	77	22365	86
21751	84	21909	81	22053	84	22130	293	22228	77	22370	86
21752	84	21910	81	22054	84	22132	293	22229	77	22398	86
21753	84	21911	80	22055	84	22133	293	22230	77	22399	86
21754	84	21912	80	22056	84	22134	293	22232	77	22510	56
21760	79	21913	80	22057	84	22135	350	22234	77	22515	56
21761	79	21914	80	22058	81	22136	350	22236	77	22520	56
21762	79	21920	80	22059	81	22137	350	22238	77	22525	56
21763	79	21925	80	22060	83	22138	350	22240	77	22530	56
21764	79	21926	80	22061	83	22140	79	22242	77	22532	56
21780	79	21930	82	22062	83	22141	79	22244	77	22535	56
21781	79	21931	82	22063	83	22142	79	22246	77	22540	56
21782	79	21935	82	22064	83	22143	79	22248	77	22542	56
21783	79	21936	82	22065	83	22145	79	22251	77	22545	56
21784	79	21937	82	22066	83	22146	79	22252	77	22548	56
21786	79	21940	82	22067	85	22147	79	22253	77	22550	56
21787	79	21941	82	22070	83	22148	79	22254	77	22555	56
21788	79	21950	81	22071	83	22150	79	22255	77	22560	56
21789	79	22001	80	22072	83	22151	79	22258	76	22565	56
21790	79	22002	80	22073	83	22155	79	22259	76	22568	56
21792	79	22003	80	22074	83	22156	79	22260	76	22570	56
21793	79	22004	80	22075	85	22158	187	22263	76	22575	56
21794	79	22005	80	22076	85	22159	187	22264	76	22580	56
21795	79	22006	80	22077	85	22160	83	22266	76	22585	56
21796	79	22007	80	22078	187	22161	83	22269	76	22590	56
21798	79	22008	80	22079	187	22162	83	22270	76	22595	56
21800	78	22009	80	22080	187	22163	83	22273	76	22600	56
21801	78	22010	80	22081	187	22164	83	22274	76	22602	56
21802	78	22011	80	22082	187	22167	83	22275	76	22605	56

POPIS KATALOŠKIH BROJEVA



šifra	stranica	šifra	stranica	šifra	stranica	šifra	stranica	šifra	stranica	šifra	stranica
22610	56	23658	209	23973	183	24111	190	24197	93	24676	72
22615	56	23660	210	23974	183	24114	191	24301	90	24677	72
22620	56	23661	209	23975	183	24115	191	24302	90	24678	72
22625	56	23664	209	23976	183	24118	93	24303	90	24680	276
22630	56	23670	203	23977	183	24119	93	24304	90	24690	202
22701	82	23671	203	23978	183	24120	93	24305	90	24691	202
22702	82	23672	203	23979	183	24121	190	24306	90	24695	202
22703	82	23673	203	23985	183	24122	190	24308	90	24700	72
22704	82	23674	203	23986	183	24124	190	24310	90	24701	72
22705	82	23675	203	23987	183	24125	190	24312	91	24702	72
22706	82	23676	203	23988	183	24126	190	24313	91	24703	72
22707	82	23677	203	23989	183	24128	193	24314	91	24704	72
23270	239	23678	203	24000	183	24130	192	24315	91	24705	72
23400	212	23679	203	24001	183	24131	192	24316	91	24706	65
23401	212	23680	203	24005	183	24132	134	24320	87	24710	73
23402	212	23681	203	24007	182	24133	192	24321	87	24712	65
23406	212	23682	203	24008	183	24134	191	24322	87	24713	65
23407	212	23683	203	24010	182	24135	192	24325	91	24714	65
23410	212	23684	203	24015	182	24136	192	24410	60	24715	65
23411	212	23685	203	24017	182	24137	192	24411	60	24716	65
23412	212	23730	168	24020	182	24140	192	24412	60	24717	69
23415	212	23731	168	24030	182	24141	192	24415	65	24718	69
23416	212	23732	168	24035	183	24142	192	24419	60	24719	69
23417	212	23734	168	24036	183	24143	191	24420	60	24720	65
23420	205	23735	168	24038	183	24144	191	24422	60	24721	65
23506	204	23736	168	24039	183	24145	191	24425	60	24722	65
23507	204	23760	185	24040	183	24147	191	24429	60	24723	69
23508	204	23761	185	24041	183	24148	192	24432	60	24725	70
23515	204	23762	185	24042	183	24149	191	24435	60	24726	70
23520	204	23763	185	24043	183	24150	192	24437	60	24727	290
23525	204	23764	185	24045	89	24151	192	24444	60	24728	290
23530	204	23800	184	24050	91	24152	193	24451	60	24729	290
23531	204	23840	322	24055	88	24152	315	24457	60	24730	69
23551	204	23845	323	24055	277	24153	190	24464	60	24731	69
23560	204	23846	323	24060	88	24155	194	24468	60	24732	69
23561	204	23847	323	24061	88	24156	194	24476	60	24734	73
23562	204	23875	223	24062	88	24158	194	24483	60	24735	70
23563	204	23875	357	24063	88	24159	194	24620	71	24736	70
23564	204	23904	185	24064	88	24159	293	24621	71	24737	70
23565	204	23906	185	24065	88	24160	93	24622	71	24738	70
23566	204	23908	185	24066	88	24161	93	24623	71	24739	70
23570	203	23910	185	24067	88	24162	93	24624	71	24740	70
23571	203	23912	185	24068	88	24163	93	24627	71	24741	70
23572	203	23914	185	24069	88	24164	93	24630	71	24743	70
23573	203	23920	184	24070	88	24165	93	24633	71	24745	70
23574	203	23922	184	24071	88	24166	93	24636	71	24746	70
23585	203	23923	184	24072	88	24167	93	24638	71	24747	70
23587	203	23924	184	24073	88	24168	93	24640	71	24748	70
23589	203	23925	184	24074	88	24169	93	24642	71	24749	70
23591	203	23927	184	24075	88	24170	190	24643	71	24750	61
23595	204	23928	184	24076	88	24171	192	24647	79	24751	61
23598	204	23945	184	24077	88	24173	192	24648	79	24752	290
23600	205	23950	183	24078	88	24174	194	24649	79	24753	290
23601	205	23951	183	24080	89	24175	194	24650	72	24755	66
23602	205	23952	183	24081	89	24176	194	24651	71	24756	66
23605	205	23953	183	24082	89	24177	194	24652	71	24757	69
23607	205	23954	183	24083	89	24178	194	24655	73	24758	69
23620	205	23955	183	24084	89	24180	93	24658	73	24759	69
23625	203	23960	185	24085	89	24181	194	24661	72	24760	72
23626	203	23961	185	24086	89	24185	93	24663	72	24761	72
23628	203	23962	185	24087	89	24186	93	24665	82	24762	72
23630	203	23963	185	24098	89	24187	93	24666	82	24763	72
23632	203	23964	185	24099	89	24188	93	24667	82	24764	72
23635	203	23965	185	24100	190	24189	93	24670	72	24765	72
23637	204	23966	185	24102	190	24190	194	24671	72	24766	72
23650	210	23967	185	24104	190	24190	293	24672	72	24767	72
23652	208	23970	183	24108	93	24192	93	24673	72	24768	72
23655	210	23971	183	24109	93	24195	93	24674	72	24769	72
23657	208	23972	183	24110	190	24196	93	24675	72	24770	70

šifra	stranica	šifra	stranica	šifra	stranica	šifra	stranica	šifra	stranica	šifra	stranica
24771	70	25206	305	28032	11	31082	245	31502	252	32166	248
24772	70	25212	305	28035	13	31091	244	31503	252	32167	248
24773	70	25215	305	28040	12	31101	244	31505	247	32168	248
24774	70	25220	305	28045	12	31111	244	31506	247	32169	248
24775	71	25224	305	28050	14	31121	244	31507	247	32170	247
24776	72	25230	305	28055	14	31131	244	31510	247	32171	248
24777	71	25240	305	28060	17	31132	244	31511	247	32172	248
24778	71	25248	305	28061	17	31140	244	31512	247	32173	247
24779	72	25260	305	28065	17	31141	244	31513	247	32174	248
24780	73	25296	305	28070	10	31142	244	31514	247	32176	248
24781	73	25350	305	28075	15	31143	244	31515	247	32186	248
24782	73	25369	305	28076	18	31144	244	31517	247	32196	248
24783	73	25370	305	28080	19	31145	244	31519	252	32206	248
24784	73	25371	305	28081	19	31146	244	31520	249	32216	248
24785	73	25372	305	28083	19	31148	244	31521	249	32226	248
24786	73	25373	305	28085	19	31150	245	31522	249	32234	248
24787	73	25374	305	28086	19	31151	245	31523	249	32240	248
24788	73	25376	305	28090	20	31155	245	31524	249	32265	250
24789	73	25378	305	28101	21	31218	247	31541	249	32268	251
24790	72	25379	305	28102	20	31220	246	31551	249	32269	251
24791	72	25380	305	28103	20	31221	246	31552	249	32270	250
24792	72	25400	305	28104	21	31222	246	31553	249	32273	250
24793	72	25410	305	28210	28	31231	246	31555	249	32283	250
24794	72	26028	111	28213	28	31232	246	31556	249	32285	250
24795	71	26201	113	28215	27	31233	246	31557	249	32293	250
24796	72	26203	112	28218	28	31234	246	31558	249	32295	251
24797	71	26204	113	28220	25	31235	246	31559	249	32296	251
24798	73	26205	112	28221	23	31270	246	31601	253	32297	251
24799	71	26209	114	28223	28	31271	246	31602	253	32298	251
25001	305	26211	113	28225	24	31280	246	31603	253	32301	251
25002	305	26216	114	28228	28	31281	246	31610	249	32302	251
25003	305	26217	114	28229	28	31320	247	31641	253	32311	255
25004	305	26218	114	28230	26	31322	247	31651	253	32312	254
25005	305	26219	114	28233	28	31330	246	31655	253	32313	251
25006	305	26520	115	28240	36	31332	246	32001	250	32314	254
25009	305	26521	115	28267	29	31334	246	32002	250	32315	255
25012	305	26705	228	28275	50	31340	246	32003	250	32316	255
25015	305	26706	228	28278	50	31341	246	32013	250	32317	254
25016	305	26707	228	28280	50	31343	246	32014	250	32318	255
25020	305	26720	228	28282	50	31360	246	32015	250	32319	255
25024	305	26721	228	28340	37	31362	246	32016	250	32320	254
25025	305	26722	228	28342	37	31380	246	32018	250	32321	255
25030	305	26730	272	28345	37	31382	246	32020	250	32322	255
25040	305	26731	272	28346	37	31390	246	32021	250	32323	255
25048	305	26735	272	30003	256	31392	246	32022	253	32324	255
25060	305	26736	272	30003	259	31400	246	32023	253	32325	255
25096	305	26740	273	30004	256	31402	246	32024	250	32326	255
25150	305	26775	292	30004	259	31403	246	32026	250	32327	254
25153	305	26780	273	30005	256	31404	246	32037	251	32328	255
25155	305	26781	273	30005	259	31452	253	32038	251	32329	254
25160	305	26782	273	30007	256	31453	253	32040	253	32330	255
25162	305	26783	273	30007	259	31454	253	32041	253	32331	255
25163	305	26973	216	31005	245	31455	247	32042	253	32332	254
25164	305	26974	216	31006	245	31456	247	32043	253	32333	254
25167	305	26975	216	31007	245	31461	248	32044	253	32335	255
25169	305	26976	216	31008	245	31467	248	32050	253	32337	254
25170	305	26977	216	31009	245	31468	248	32051	253	32338	254
25171	305	28000	4	31011	245	31471	248	32052	253	33168	254
25179	305	28001	5	31021	245	31481	248	32053	253	33275	296
25180	305	28002	5	31031	245	31491	248	32060	250	34005	256
25181	305	28003	6	31041	245	31493	248	32062	250	34006	256
25182	305	28004	6	31051	245	31494	248	32064	250	34007	256
25183	305	28005	7	31052	245	31495	248	32066	250	34027	255
25184	305	28006	7	31053	245	31496	248	32089	251	34028	255
25186	305	28007	8	31061	245	31497	252	32161	248	34033	260
25188	305	28008	8	31062	245	31498	248	32162	248	34041	256
25189	305	28021	9	31071	245	31499	248	32163	248	34051	256
25190	305	28025	9	31072	245	31500	248	32164	248	34053	256
25195	305	28030	11	31081	245	31501	252	32165	248	34061	256

POPIS KATALOŠKIH BROJEVA



šifra	stranica	šifra	stranica	šifra	stranica	šifra	stranica	šifra	stranica	šifra	stranica
34071	256	34405	258	35082	263	35345	40	36130	277	37115	291
34081	256	34406	259	35085	262	35345	286	36136	277	37117	278
34091	256	34407	259	35086	262	35346	41	36138	277	37119	291
34101	256	34409	259	35087	262	35346	288	36139	277	37120	291
34111	256	34410	259	35091	262	35347	41	36140	277	37121	296
34115	256	34411	259	35092	262	35347	288	36145	274	37122	296
34116	256	34412	259	35093	262	35348	40	36160	274	37123	364
34117	256	34413	259	35094	263	35348	286	36175	274	37124	364
34121	256	34414	259	35095	263	35360	46	36190	274	37125	282
34122	256	34415	258	35096	263	35361	46	36191	274	37126	282
34132	256	34416	258	35103	264	35362	46	36195	277	37127	282
34142	256	34417	259	35113	264	35500	266	36199	274	37129	364
34152	256	34418	259	35123	264	35501	266	36200	274	37130	281
34153	256	34419	258	35125	264	35502	266	36300	209	37131	281
34154	256	34420	258	35126	264	35503	266	36308	292	37132	281
34155	256	34421	259	35127	264	35504	266	36310	273	37135	231
34156	256	34422	259	35142	262	35505	266	36312	292	37139	231
34157	256	34423	259	35300	38	35506	266	36318	283	37140	231
34158	256	34424	259	35300	261	35507	266	36319	283	37141	231
34159	256	34425	259	35305	39	35508	266	36325	283	37142	231
34160	256	34426	259	35305	262	35510	266	36326	16	37143	231
34200	252	34428	259	35310	38	35511	266	36326	283	37144	231
34201	252	34429	259	35310	261	35512	266	36328	16	37145	231
34202	252	34439	258	35311	38	35514	266	36329	16	37148	282
34203	252	34440	258	35311	261	35515	266	36410	208	37149	282
34221	260	34441	258	35315	39	35516	266	37005	302	37150	282
34223	260	34442	258	35315	262	35517	266	37006	279	37151	282
34231	260	34443	258	35316	38	35518	267	37006	279	37152	282
34235	260	34445	258	35316	261	35519	267	37007	279	37153	282
34237	260	34446	258	35317	38	35524	267	37007	279	37154	282
34238	260	34447	258	35317	261	35525	267	37008	279	37155	280
34241	260	34448	259	35318	38	35527	267	37009	279	37156	280
34243	260	34449	258	35318	261	35532	267	37011	278	37157	280
34251	260	34450	258	35319	38	35533	267	37012	279	37158	282
34261	260	34451	258	35319	261	35539	267	37021	278	37162	281
34262	260	34452	259	35320	50	35540	267	37025	278	37166	273
34265	260	34453	258	35322	50	35542	267	37025	278	37170	281
34271	252	34454	258	35323	42	35552	267	37026	278	37171	281
34272	252	34455	259	35323	289	35553	267	37026	278	37172	281
34273	252	34456	259	35325	42	35555	267	37028	278	37173	282
34274	252	34457	259	35325	289	35603	269	37028	278	37174	282
34275	252	34458	259	35326	42	35604	269	37029	278	37175	281
34276	252	34480	258	35326	289	35605	269	37029	278	37176	281
34280	252	34481	258	35327	42	35833	52	37031	253	37177	282
34281	252	34482	258	35327	289	35845	52	37041	253	37178	282
34282	252	34485	258	35328	42	35850	52	37050	278	37185	281
34283	252	34486	258	35328	42	36014	276	37051	253	37186	281
34284	252	34490	259	35328	289	36024	276	37052	278	37187	281
34285	252	34491	259	35328	289	36034	276	37053	278	37188	281
34300	292	34496	259	35329	42	36035	276	37054	278	37189	281
34301	252	34500	260	35329	42	36036	276	37055	278	37190	281
34303	292	35006	263	35329	289	36046	276	37065	284	37192	281
34304	252	35007	263	35329	289	36056	277	37066	284	37195	282
34305	252	35011	264	35330	40	36057	277	37067	284	37196	282
34305	292	35012	263	35330	287	36058	277	37068	284	37197	282
34306	252	35013	263	35331	41	36059	277	37069	284	37198	282
34306	292	35015	264	35331	288	36076	275	37070	284	37199	282
34307	252	35021	264	35332	41	36077	275	37094	284	37200	280
34307	292	35023	262	35332	288	36080	275	37095	284	37201	280
34308	252	35038	262	35333	41	36081	275	37096	284	37202	280
34308	292	35048	264	35333	288	36082	275	37097	284	37203	280
34315	293	35058	262	35334	41	36085	275	37098	284	37204	280
34316	131	35059	263	35334	288	36086	275	37101	253	37205	280
34316	293	35068	264	35335	42	36087	275	37102	280	37210	280
34400	258	35069	263	35335	289	36102	275	37105	280	37211	280
34401	258	35070	263	35336	41	36103	275	37106	280	37212	280
34402	259	35078	263	35336	288	36105	275	37107	280	37216	291
34403	259	35079	263	35344	41	36126	277	37111	253	37217	291
34404	258	35081	263	35344	287	36128	277	37114	291	37218	291

šifra	stranica	šifra	stranica	šifra	stranica	šifra	stranica	šifra	stranica	šifra	stranica
37220	280	37344	236	38022	299	38949	224	39217	290	42179	353
37230	292	37345	236	38024	297	38950	290	39218	290	42180	354
37231	292	37350	235	38025	298	38951	290	39219	290	42181	354
37232	292	37500	267	38026	279	38952	290	39238	292	42182	354
37233	292	37501	267	38027	297	38953	290	39240	290	42185	354
37234	292	37505	267	38028	297	38954	290	39241	290	42186	354
37235	292	37506	267	38030	299	38955	224	39242	290	42187	354
37236	291	37509	268	38031	299	38956	224	39243	290	42188	354
37237	291	37510	268	38032	297	38957	224	39244	290	42190	224
37238	291	37511	268	38042	279	38958	224	39245	292	42190	354
37239	291	37512	268	38045	279	38959	224	40050	353	42201	355
37243	303	37515	268	38050	223	38960	224	40051	353	42202	355
37244	303	37516	268	38052	223	38961	224	40052	353	42203	355
37245	303	37517	268	38054	223	38963	226	40053	353	42207	355
37246	303	37518	268	38055	223	38964	225	40054	353	42208	355
37247	303	37527	268	38060	223	38965	225	40055	353	42209	355
37248	303	37530	268	38063	223	38966	225	40056	353	42210	355
37250	303	37532	268	38065	223	38968	224	40057	353	42211	355
37251	303	37533	268	38095	223	38969	226	40058	353	42212	355
37252	303	37539	269	38096	223	38970	290	40059	353	42213	355
37253	303	37541	269	38097	223	38971	290	40060	353	42214	355
37255	225	37545	307	38895	284	38972	226	40075	353	42217	355
37256	225	37546	307	38896	284	38973	226	40076	353	42218	355
37257	225	37549	210	38899	284	38975	226	40077	353	42219	355
37258	225	37553	212	38900	284	38980	224	40100	352	42220	355
37259	225	37560	209	38901	285	38981	224	40120	352	42221	355
37263	225	37564	269	38902	285	38985	226	41050	352	42228	355
37264	225	37570	192	38903	285	38990	225	41080	352	42229	355
37266	225	37570	209	38904	285	38991	225	41081	352	42230	355
37267	225	37611	53	38905	285	38995	225	41082	352	42244	355
37268	225	37615	53	38906	285	39000	296	41083	352	42248	355
37270	225	37616	53	38907	284	39001	296	41100	352	42249	355
37271	225	37647	218	38908	284	39002	296	41101	352	42251	355
37272	225	37660	306	38909	284	39003	296	41102	352	42252	355
37273	225	37730	53	38910	285	39005	296	41103	352	42253	355
37275	225	37731	53	38911	285	39010	296	41120	352	42255	355
37280	226	37732	53	38912	285	39012	296	41121	352	42256	355
37281	226	37733	53	38913	285	39014	296	41122	352	42257	355
37285	282	37740	53	38914	285	39020	296	41123	352	42260	355
37286	282	37741	53	38915	285	39021	296	41150	352	42261	355
37287	282	37744	53	38916	285	39045	296	41151	352	42312	291
37288	282	37745	53	38917	285	39065	296	41152	352	42312	354
37289	282	37746	53	38918	285	39090	296	41153	352	42365	222
37290	303	37747	53	38919	279	39145	296	42101	352	42366	222
37291	303	37750	53	38920	279	39165	296	42102	352	42367	222
37295	226	37751	53	38923	279	39190	296	42103	352	42368	222
37296	226	37760	53	38924	225	39192	296	42115	291	42420	291
37297	226	37761	53	38925	224	39192	323	42120	291	43050	358
37300	235	38000	298	38926	226	39193	296	42150	353	43058	358
37301	235	38001	297	38927	224	39193	323	42151	353	43060	358
37302	235	38002	298	38928	225	39194	223	42152	353	43068	358
37303	235	38003	298	38929	225	39195	223	42153	353	43071	358
37308	236	38004	299	38930	226	39196	223	42155	353	43072	358
37309	236	38005	299	38931	224	39197	223	42156	353	43077	358
37310	235	38006	298	38932	224	39198	223	42157	353	43082	358
37311	235	38007	298	38933	226	39199	223	42158	353	43083	358
37317	313	38008	298	38934	225	39200	223	42160	353	43084	358
37320	235	38009	298	38935	226	39201	223	42161	353	43086	358
37321	235	38010	298	38937	226	39202	223	42162	353	43087	359
37325	234	38012	297	38939	226	39203	223	42163	353	43089	359
37326	234	38013	297	38940	226	39204	223	42170	354	43090	359
37328	234	38014	299	38941	226	39205	223	42171	354	43094	359
37330	234	38014	299	38942	225	39206	290	42172	354	43097	358
37331	234	38015	299	38943	226	39207	290	42173	354	43098	359
37332	234	38016	299	38944	224	39208	290	42174	354	43099	359
37340	236	38017	299	38945	224	39210	290	42175	353	43300	347
37341	236	38018	299	38946	224	39212	290	42176	353	43301	347
37342	236	38020	298	38947	224	39214	290	42177	353	44041	322
37343	236	38021	299	38948	224	39216	290	42178	353	44042	322

POPIS KATALOŠKIH BROJEVA



šifra	stranica	šifra	stranica	šifra	stranica	šifra	stranica	šifra	stranica	šifra	stranica
44043	322	45034	319	45099	310	45178	333	45268	335	45391	324
44050	322	45035	318	45100	334	45179	331	45269	335	45392	324
44053	319	45036	322	45101	334	45180	327	45270	39	45393	324
44950	131	45038	319	45102	334	45181	327	45271	39	45394	324
44950	315	45039	319	45104	334	45182	333	45280	334	45395	324
44955	319	45040	319	45105	334	45183	333	45283	334	45396	325
44960	323	45041	319	45106	334	45184	331	45285	334	45397	325
44965	338	45042	319	45107	334	45185	331	45286	334	45398	325
44970	313	45043	323	45108	334	45186	331	45287	334	45399	325
44971	313	45044	322	45110	326	45187	332	45289	329	45400	325
44972	310	45045	136	45111	327	45190	332	45290	329	45401	325
44980	310	45045	320	45112	327	45191	332	45291	329	45450	357
44980	310	45046	136	45113	327	45192	332	45292	329	45451	357
44980	311	45046	320	45114	327	45193	332	45293	329	45452	357
44981	310	45047	323	45115	327	45194	332	45294	328	45453	357
44981	310	45048	136	45116	326	45195	332	45295	328	45460	357
44981	311	45048	312	45117	326	45196	332	45296	328	45461	357
44981	311	45048	320	45118	326	45197	332	45297	328	45462	357
44982	310	45049	322	45120	327	45198	332	45298	328	45463	357
44982	310	45050	338	45122	327	45199	332	45299	328	45465	357
44982	311	45051	338	45123	326	45200	332	45300	333	45466	357
44983	310	45052	338	45124	326	45203	332	45301	333	45467	357
44983	310	45053	339	45125	326	45204	332	45320	339	45470	357
44983	311	45054	339	45126	326	45206	332	45321	339	45471	226
44984	311	45055	339	45130	329	45211	332	45323	337	45471	323
44984	312	45056	318	45131	329	45213	328	45323	348	45472	323
44984	312	45057	318	45132	329	45214	327	45325	337	45473	323
44985	311	45058	318	45133	329	45215	329	45326	337	45480	357
44985	312	45059	318	45134	330	45216	328	45326	337	45485	357
44991	311	45060	193	45135	329	45217	329	45327	337	45490	314
44992	311	45060	315	45136	329	45218	328	45328	337	45496	357
44995	314	45061	193	45137	329	45219	329	45329	337	45497	357
44996	312	45061	315	45138	328	45220	334	45330	337	45498	357
44997	312	45062	193	45139	328	45221	334	45330	350	45499	357
44998	312	45062	315	45140	328	45222	334	45331	337	45500	321
44999	313	45063	310	45141	328	45223	334	45331	350	45502	321
45000	314	45065	318	45142	328	45224	334	45341	333	45503	321
45001	314	45066	318	45143	328	45225	334	45342	333	45505	321
45002	314	45067	318	45144	329	45226	334	45343	333	45506	321
45003	314	45068	136	45145	329	45227	334	45344	333	45508	321
45005	314	45068	312	45146	330	45228	334	45345	333	45509	321
45006	314	45068	320	45147	331	45229	334	45346	333	45511	321
45007	314	45069	131	45150	331	45239	336	45347	333	45512	321
45008	314	45069	315	45151	331	45240	336	45348	333	45513	321
45009	314	45070	340	45152	330	45241	336	45349	333	45515	321
45010	312	45071	338	45153	330	45242	336	45350	333	45516	321
45011	313	45073	136	45154	330	45244	335	45351	333	45517	321
45012	313	45073	320	45155	330	45245	335	45352	333	45518	321
45014	312	45074	323	45156	331	45246	335	45353	333	45519	321
45015	313	45079	319	45158	330	45247	335	45354	333	45520	321
45016	313	45080	319	45159	331	45248	335	45370	136	45521	321
45017	311	45081	131	45160	331	45249	335	45370	320	45522	321
45018	312	45081	315	45161	331	45250	335	45372	325	45523	321
45019	312	45082	131	45162	330	45251	335	45372	333	45524	321
45020	310	45082	315	45163	330	45253	335	45373	325	45525	321
45021	312	45083	131	45164	331	45254	335	45373	333	45526	321
45023	310	45083	315	45167	330	45256	335	45374	325	45527	321
45025	313	45084	131	45168	331	45257	335	45374	333	45528	321
45026	312	45084	315	45169	331	45260	335	45375	325	45529	321
45027	313	45085	319	45170	336	45261	335	45375	333	45530	321
45029	313	45086	323	45171	336	45262	335	45376	325	45531	321
45030	193	45088	311	45172	336	45262	335	45376	333	45532	321
45030	315	45089	311	45172	336	45263	335	45377	325	45533	321
45031	193	45093	323	45173	336	45263	335	45377	333	45534	321
45031	315	45094	311	45173	336	45265	335	45385	324	45535	322
45032	193	45095	310	45174	333	45266	335	45386	324	45540	321
45032	315	45096	310	45175	332	45267	335	45388	324	45541	321
45033	193	45097	311	45176	333	45267	335	45389	324	45542	321
45033	315	45098	310	45177	333	45268	335	45390	324	45543	321

šifra	stranica	šifra	stranica	šifra	stranica	šifra	stranica	šifra	stranica	šifra	stranica
45550	321	45660	322	48094	49	50544	233	51244	227	52055	307
45551	321	45661	322	48095	49	50549	232	51245	227	52060	307
45552	321	45662	322	48096	49	50550	230	51246	227	52065	307
45553	321	45663	322	48097	49	50551	230	51247	227	52070	300
45555	322	45664	322	48410	306	50553	230	51258	227	52071	300
45556	321	45670	322	48411	306	50554	230	51259	227	52075	300
45557	321	45671	322	48415	306	50555	233	51260	227	52076	300
45558	321	45672	322	48420	306	50556	230	51261	227	52077	300
45559	321	45673	322	48452	307	50557	232	51262	227	52078	300
45560	322	48001	48	48453	307	50558	232	51264	227	52101	349
45562	321	48002	48	48454	307	50559	230	51271	227	52102	349
45563	321	48004	47	48455	307	50560	230	51272	227	52103	349
45564	321	48005	47	48456	307	50562	230	51273	227	52104	349
45565	321	48006	47	48457	307	50563	230	51274	227	52105	349
45570	354	48007	47	48719	273	50564	230	51275	227	52108	348
45571	354	48008	49	48729	269	50570	230	51276	227	52109	349
45572	354	48009	49	48730	269	50571	230	51278	227	52113	349
45573	354	48010	48	48731	269	50585	233	51280	227	52114	349
45580	354	48011	48	50030	355	50585	303	51281	227	52115	349
45600	334	48013	15	50031	355	50586	233	51282	227	52116	349
45601	334	48013	48	50032	355	50586	303	51283	227	52119	348
45602	334	48015	47	50033	355	50587	233	51284	227	52126	350
45603	334	48020	46	50035	228	50587	303	51286	227	52130	280
45604	334	48021	46	50035	355	50588	233	51287	227	52135	348
45605	334	48022	46	50036	228	50588	303	51288	227	52160	349
45606	334	48030	47	50036	355	51100	228	51300	227	52161	349
45607	334	48031	48	50037	355	51102	228	51301	227	52162	349
45608	334	48032	48	50038	355	51103	228	51302	227	52163	349
45609	334	48033	48	50040	355	51104	228	51303	227	52164	349
45610	334	48034	48	50041	355	51105	228	51304	227	52168	348
45611	334	48036	47	50042	355	51106	228	51305	227	52173	348
45612	334	48037	47	50050	222	51107	228	51306	227	52175	348
45613	334	48040	48	50050	222	51108	228	51307	227	52176	348
45614	334	48041	48	50051	222	51109	228	51308	227	52185	349
45615	334	48042	48	50052	222	51110	228	51320	227	52186	349
45616	334	48043	48	50052	222	51111	228	51321	227	52187	349
45617	334	48046	46	50100	227	51120	228	51322	227	52188	349
45618	334	48046	49	50101	227	51121	228	51323	227	52189	349
45619	334	48047	46	50102	227	51122	228	51324	227	52190	349
45620	334	48047	49	50103	227	51123	228	51325	227	52191	349
45621	334	48050	49	50104	227	51124	228	51327	227	52192	349
45622	334	48051	49	50106	227	51125	228	51341	227	52193	349
45623	334	48054	49	50108	227	51126	228	51402	228	52194	349
45624	334	48055	49	50500	233	51127	228	51403	228	52195	349
45625	334	48056	49	50503	233	51130	228	51404	228	52196	349
45626	334	48057	49	50510	230	51131	228	51405	228	52197	348
45627	334	48060	49	50511	230	51132	228	51406	228	52198	348
45628	334	48061	49	50512	230	51196	228	51407	228	52202	300
45629	334	48062	49	50513	230	51197	228	51408	228	52203	300
45630	334	48063	49	50514	230	51198	228	51410	228	52204	300
45631	334	48064	49	50518	232	51199	228	51412	228	52205	300
45632	334	48065	49	50519	232	51204	227	51413	228	52206	300
45633	334	48066	49	50520	232	51205	227	51414	228	52207	300
45634	334	48067	49	50522	232	51206	227	51415	228	52208	300
45635	334	48068	49	50524	232	51207	227	51416	228	52212	300
45636	334	48070	49	50525	232	51208	227	51417	228	52213	300
45637	334	48071	49	50526	232	51209	227	51418	228	52214	300
45638	334	48072	49	50527	233	51210	227	51420	228	52215	300
45639	334	48075	49	50529	232	51211	227	51430	228	52216	300
45650	322	48076	49	50531	233	51212	227	51431	228	52217	300
45651	322	48077	49	50532	233	51220	227	51432	228	52218	300
45652	322	48080	49	50533	232	51221	227	51433	228	52220	300
45653	322	48081	49	50535	232	51222	227	51435	228	52283	300
45654	322	48085	49	50536	232	51225	227	51436	228	52284	300
45655	322	48086	49	50537	232	51226	227	51450	228	52285	300
45656	322	48087	49	50539	232	51227	227	52011	249	52286	300
45657	322	48090	49	50540	233	51241	227	52011	303	52288	300
45658	322	48091	49	50541	233	51242	227	52030	252	52305	301
45659	322	48093	49	50542	233	51243	227	52050	307	52306	301

POPIS KATALOŠKIH BROJEVA



šifra	stranica	šifra	stranica	šifra	stranica	šifra	stranica	šifra	stranica	šifra	stranica
52328	301	55356	229	61003	344	61098	345	61236	217	70025	44
52331	301	55357	229	61004	344	61098	351	61240	197	70026	44
52334	301	55358	229	61005	341	61111	346	61250	351	70030	44
52391	301	55359	229	61005	351	61112	346	61251	319	70031	44
52421	301	55360	229	61006	341	61114	346	61251	351	70032	44
52424	301	55361	229	61006	351	61120	346	61252	351	70033	44
52428	301	55362	229	61007	341	61121	346	61253	351	70035	44
52456	301	55400	356	61008	341	61130	338	61254	351	70036	44
52471	301	55401	356	61009	345	61131	338	61255	351	70037	44
52600	302	55402	356	61010	341	61132	339	61256	351	70040	43
52601	302	55403	356	61012	345	61133	339	61290	346	70060	44
52602	302	55404	356	61013	344	61134	339	61291	346	70061	44
52605	302	55405	356	61014	345	61135	339	61292	346	70062	44
52610	302	55406	356	61015	341	61141	339	61293	346	70063	44
52611	248	55420	356	61018	345	61142	340	61294	318	70064	43
52612	248	55421	356	61019	344	61143	340	61295	318	70065	44
52620	302	55422	356	61020	342	61144	340	61296	318	70066	43
52625	302	55423	356	61021	342	61145	340	61297	318	70070	44
52630	302	55424	356	61022	343	61146	340	61299	356	70075	44
52635	302	55425	356	61024	343	61150	338	61300	356	70090	45
52640	302	55429	356	61025	342	61155	341	61301	356	70091	45
52645	302	55430	356	61026	342	61156	341	61302	356	70092	45
52652	302	55431	356	61027	343	61157	341	61320	197	70093	45
52656	302	55432	356	61028	345	61158	341	61321	197	70094	45
52662	302	55433	356	61029	341	61161	344	61322	197	70095	45
52666	302	55436	356	61030	340	61162	344	61323	197	70096	45
52671	302	55437	356	61031	340	61163	344	61324	197	70098	210
52694	302	55450	356	61032	340	61164	345	61325	197	81011	361
52695	302	55452	356	61033	340	61165	345	61326	197	81012	361
54008	303	55453	356	61034	340	61166	345	61327	197	81013	361
55040	229	55454	356	61035	346	61169	251	61328	197	81014	361
55050	229	55455	356	61036	346	61171	350	61329	197	81015	361
55051	229	55456	356	61038	346	61172	348	61330	197	81016	361
55060	229	55457	356	61040	346	61172	350	61331	197	81022	361
55080	229	55460	356	61042	346	61173	350	61340	317	81023	361
55100	229	55461	356	61044	345	61174	350	61341	317	81024	361
55120	229	55462	356	61045	340	61175	350	61342	317	81025	361
55140	229	55465	356	61046	340	61176	350	61343	317	81035	361
55160	229	55640	229	61047	340	61177	350	61344	317	81036	361
55180	229	55642	229	61048	340	61183	351	61345	317	81053	364
55181	229	55645	229	61050	342	61184	351	61346	317	81054	364
55200	229	55650	229	61050	351	61189	351	65062	307	81057	364
55201	229	60001	347	61051	342	61190	351	65063	307	81070	364
55220	229	60006	347	61051	351	61192	350	65064	307	81071	364
55221	229	60008	347	61052	343	61193	350	65065	307	81077	364
55240	229	60012	347	61052	351	61194	350	69900	294	81100	364
55300	229	60018	347	61053	343	61195	351	69901	294	81101	364
55315	229	60019	347	61054	343	61200	350	69902	294	81102	364
55316	229	60020	347	61056	342	61201	347	69903	294	81103	364
55317	229	60022	347	61057	342	61201	350	69904	295	81104	364
55318	229	60100	251	61058	343	61202	350	69905	294	81105	364
55319	229	60115	273	61059	343	61203	345	69906	294	81106	364
55331	229	60116	273	61060	340	61204	351	69907	295	81150	362
55332	229	60117	273	61061	340	61205	351	69908	295	81151	362
55333	229	60118	273	61062	340	61207	351	69909	295	81152	362
55334	229	60121	273	61063	340	61208	350	69910	295	81155	362
55335	229	60123	273	61067	346	61209	345	69911	295	81160	362
55336	229	60125	272	61068	346	61215	351	69912	295	81165	362
55337	229	60130	272	61069	346	61218	251	69914	294	81170	362
55339	229	60132	272	61070	346	61219	351	69917	295	81175	362
55340	229	60155	272	61077	351	61221	318	69918	294	81178	362
55341	229	60157	272	61079	351	61221	318	69919	294	81180	362
55342	229	60201	347	61079	351	61221	318	69920	295	81185	362
55350	229	60206	347	61085	319	61221	318	69923	295	81186	362
55351	229	60208	347	61088	342	61222	345	69928	295	81188	362
55352	229	60212	347	61089	342	61223	344	69930	296	81189	362
55353	229	61000	342	61090	343	61224	346	69931	296	81190	362
55354	229	61001	342	61097	344	61224	346	70020	44	81191	362
55355	229	61002	343	61097	351	61230	351	70021	44	81195	361

šifra	stranica	šifra	stranica	šifra	stranica	šifra	stranica	šifra	stranica	šifra	stranica
81196	361	81267	363	81337	363	81408	363	82103	307		
81197	361	81268	363	81338	363	81409	363	82104	307		
81200	363	81269	363	81339	363	81410	363	89775	51		
81201	363	81270	363	81340	363	81411	363	89970	51		
81202	363	81271	363	81341	363	81412	363	89973	51		
81203	363	81272	363	81342	363	81413	363	89975	51		
81204	363	81273	363	81343	363	81414	363	89980	51		
81205	363	81274	363	81344	363	81415	363	89985	51		
81206	363	81275	363	81345	363	81416	363	89987	51		
81207	363	81276	363	81346	363	81417	363	89988	51		
81208	363	81277	363	81347	363	81418	363	89989	51		
81209	363	81278	363	81348	363	81419	363	89990	51		
81210	363	81279	363	81349	363	81420	363	90070	278		
81211	363	81280	363	81350	363	81421	363	90071	278		
81212	363	81281	363	81351	363	81422	363	90072	278		
81213	363	81282	363	81352	363	81423	363	90191	56		
81214	363	81284	363	81353	363	81424	363	90192	57		
81215	363	81285	363	81354	363	81425	363	18610A	150		
81216	363	81286	363	81355	363	81426	363	18611A	150		
81217	363	81287	363	81356	363	81427	363	18612A	150		
81218	363	81288	363	81357	363	81428	363	18613A	150		
81219	363	81289	363	81358	363	81429	363	18614A	150		
81220	363	81290	363	81359	363	81430	363	18615A	150		
81221	363	81291	363	81360	363	81431	363	18632A	147		
81222	363	81292	363	81361	363	81432	363	18633A	147		
81223	363	81293	363	81362	363	81433	363	18636A	147		
81224	363	81294	363	81363	363	81434	363	18637A	147		
81225	363	81295	363	81364	363	81435	363	18638A	147		
81226	363	81296	363	81365	363	81436	363	18827A	147		
81227	363	81297	363	81366	363	81437	363	18828A	147		
81228	363	81298	363	81367	363	81438	363	18830A	147		
81229	363	81299	363	81370	363	81439	363	18831A	147		
81230	363	81300	363	81371	363	81440	363	81011A	361		
81231	363	81301	363	81372	363	81441	363	81011F	361		
81232	363	81302	363	81373	363	81442	363	81011G	361		
81233	363	81303	363	81374	363	81443	363	81011H	361		
81234	363	81304	363	81375	363	81444	363	81011R	361		
81235	363	81305	363	81376	363	81445	363	M90203	365		
81236	363	81306	363	81377	363	81447	363	M90204	365		
81237	363	81307	363	81378	363	81448	363	M90205	365		
81238	363	81308	363	81379	363	81449	363	M90206	365		
81239	363	81309	363	81380	363	81450	363	M90207	365		
81240	363	81310	363	81381	363	81451	363	M90210	365		
81241	363	81311	363	81382	363	81452	363	M90220	365		
81242	363	81312	363	81383	363	81453	363	M90221	365		
81243	363	81313	363	81384	363	81454	363	M90222	365		
81244	363	81314	363	81385	363	81455	363	M90400	365		
81245	363	81315	363	81386	363	81456	363	M90403	365		
81246	363	81316	363	81387	363	81457	363	M90519	365		
81247	363	81317	363	81388	363	81458	363				
81248	363	81318	363	81389	363	81459	363				
81249	363	81319	363	81390	363	81460	363				
81250	363	81320	363	81391	363	81461	363				
81251	363	81321	363	81392	363	81462	363				
81252	363	81322	363	81393	363	81463	363				
81253	363	81323	363	81394	363	81466	363				
81254	363	81324	363	81395	363	81467	363				
81255	363	81325	363	81396	363	81468	363				
81256	363	81326	363	81397	363	81469	363				
81257	363	81327	363	81398	363	81470	363				
81258	363	81328	363	81399	363	81471	363				
81259	363	81329	363	81400	363	81472	363				
81260	363	81330	363	81401	363	81473	363				
81261	363	81331	363	81402	363	81486	363				
81262	363	81332	363	81403	363	81600	364				
81263	363	81333	363	81404	363	81603	364				
81264	363	81334	363	81405	363	82100	307				
81265	363	81335	363	81406	363	82101	307				
81266	363	81336	363	81407	363	82102	307				

GRAFIČKI SIMBOLI KORIŠTENI U KATALOGU

· SPECIFIKACIJE PROIZVODA ·

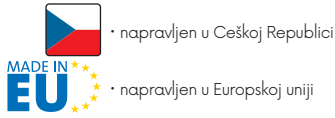

SPECIFIKACIJE APLIKACIJE ·

- drvo ·
- keramika ·
- plastika ·
- aluminij ·
- bakar ·
- kamen ·
- staklo ·
- zidanje ·
- papir ·
- željezo ·
- composite ·
- pločice ·
- inox ·
- žbuka ·
- drvo s vijcima, čavlima ·
- suh malter ·
- za bušenje u materijalima zateznom snagom do ...

- S2** · sastav proizvoda - alatni čelik S2
- HSS** · sastav proizvoda - čelik za brzo rezanje
- Cr-Mo** · sastav proizvoda - krom-molibden čelik
- CrV** · sastav proizvoda - krom-vanadijum čelik
- INOX** · sastav proizvoda - ne hrđajući čelik
- NYLON** · najlon drška
- TEFLON** · teflonska površina
- Zn** · pocinčana površina
- TiN** · površina premazana titanovim nitridom
- HRC 58-61** · HRC - tvrdoća materijala
- 40% PES** · materijal: 40% poliestera
- PES** · materijal: 100% poliestera
- dijamantski površinski tretman
- proizvod ili njegov dio je magnetni

- SDS+** **SDS MAX** **M14** · vrsta ugradnje
- broj zuba u ruci
- 1/2"** **3/4"** **1/4"** · veličina
- information about hearing protection
- DIN 3113** **IP 54** · standard
- 32x** · broj komada u paketu
- II. class** **III. class** · klasa točnosti
- pogodno za hladno vrijeme
- ergonomska rucka
- HOBBY** · hobby
- tip i broj potrebnih baterija
- UV stabilna
- gumene završne kapice otporne na udarce

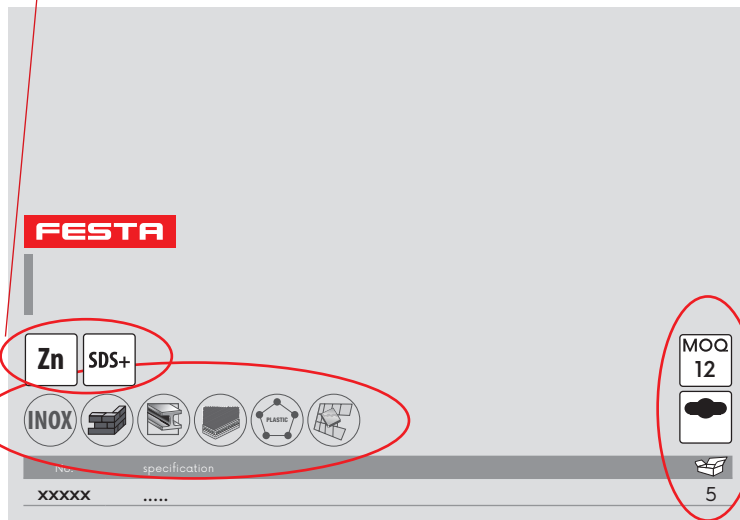

· AMBALAŽA ·

- pakirano u kutiju
- euroslot
- MOQ 12** · minimalna količina narudžbe
- broj komada u pakiranju

SPECIFIKACIJE PROIZVODA FESTA AQUATIC A ROSA ·

podesivi uzorci spreja ·

- minimalni i maksimalni tlak vode ·
- maksimalny przepływ wody ·
- navodnjavano područje ·
- veličina navoja adaptera ·
- promjer crijeva za priključak ·



20

25

26

FESTA

PROFESIONALNI X ALATI



festatools



#festatools



festatools



www.festa.tools

HORIZONTAL

FESTA
POWER X TOOLS

FESTA
AQUATIC

ROSA KOMELON

KDS

Stahlberg

SUPER PRO

Lescha

